

- 1: 9.5 ↘
- 2: 9.5 ↑
- 3: 9.8 ↑
- 4: 10.0 ↘
- 5: 10.6 ✕
- 6: 9.6 ←
- 7: 10.5 ✕➤
- 8: 9.0 ↑
- 9: 9.2 ↑
- 10: 8.2 ➤

Serie 92.0

Total 192.0

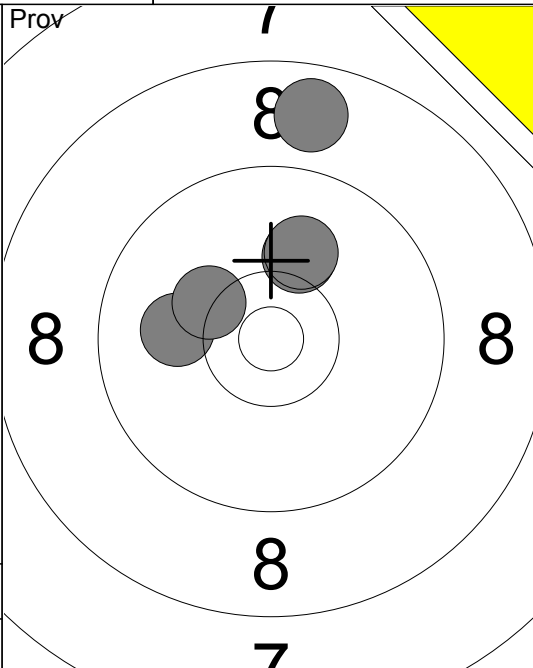

- 11: 8.8 ↑
- 12: 10.1 ↑
- 13: 10.1 ←
- 14: 10.1 ↑
- 15: 10.3 ↘

Serie 48.0

Total 192.0

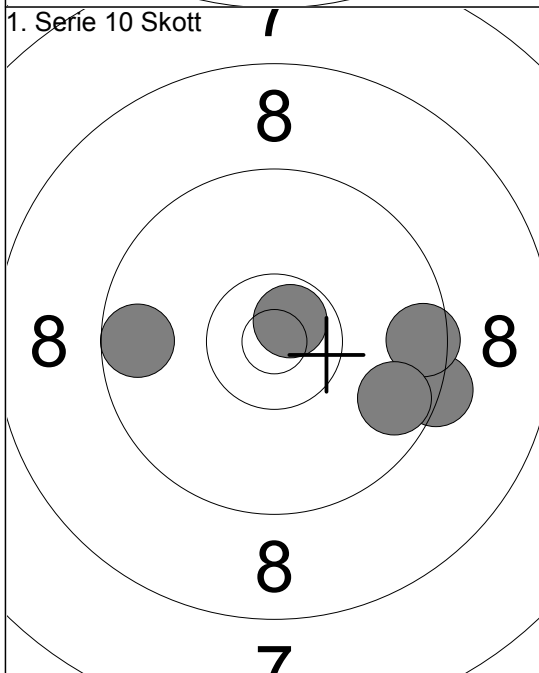

- 1: 9.3 ➤
- 2: 9.5 ➤
- 3: 9.7 ➤
- 4: 9.6 ←
- 5: 10.7 ✕↗

Serie 46.0

Total 238.0

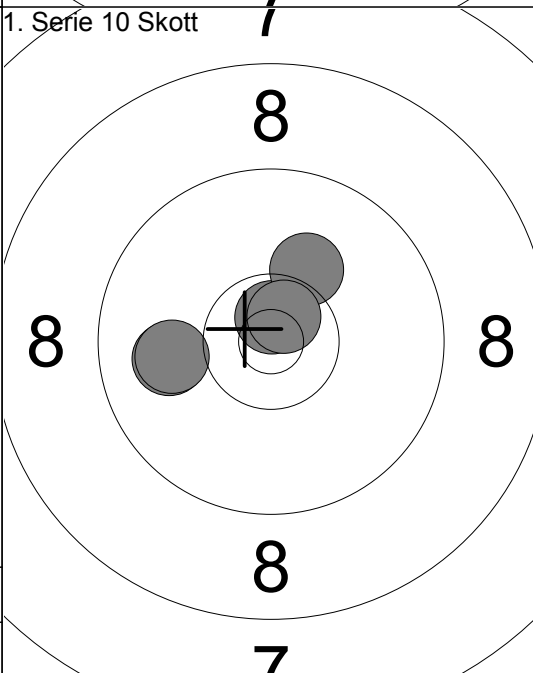

- 6: 10.7 ✕↗
- 7: 10.0 ←
- 8: 10.2 ↑
- 9: 10.0 ←
- 10: 10.7 ✕↗

Serie 50.0

Total 288.0

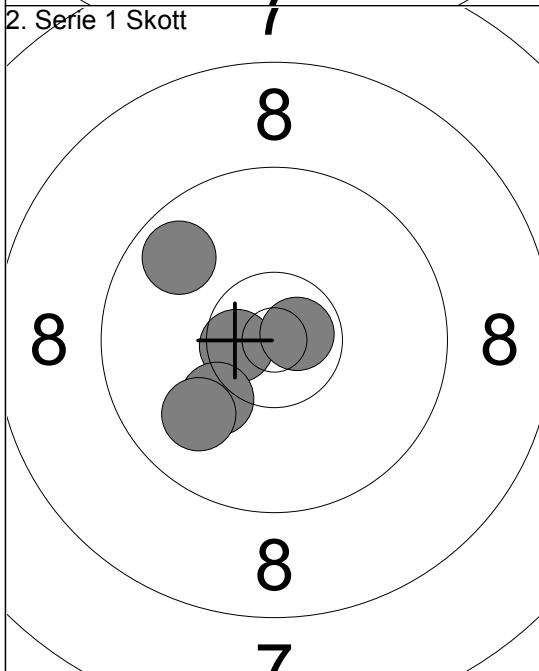

- 1: 9.8 ↘
- 2: 10.6 ✕
- 3: 10.7 ✕➤
- 4: 10.2 ↘
- 5: 9.9 ↘

Serie 48.0

Total 336.0

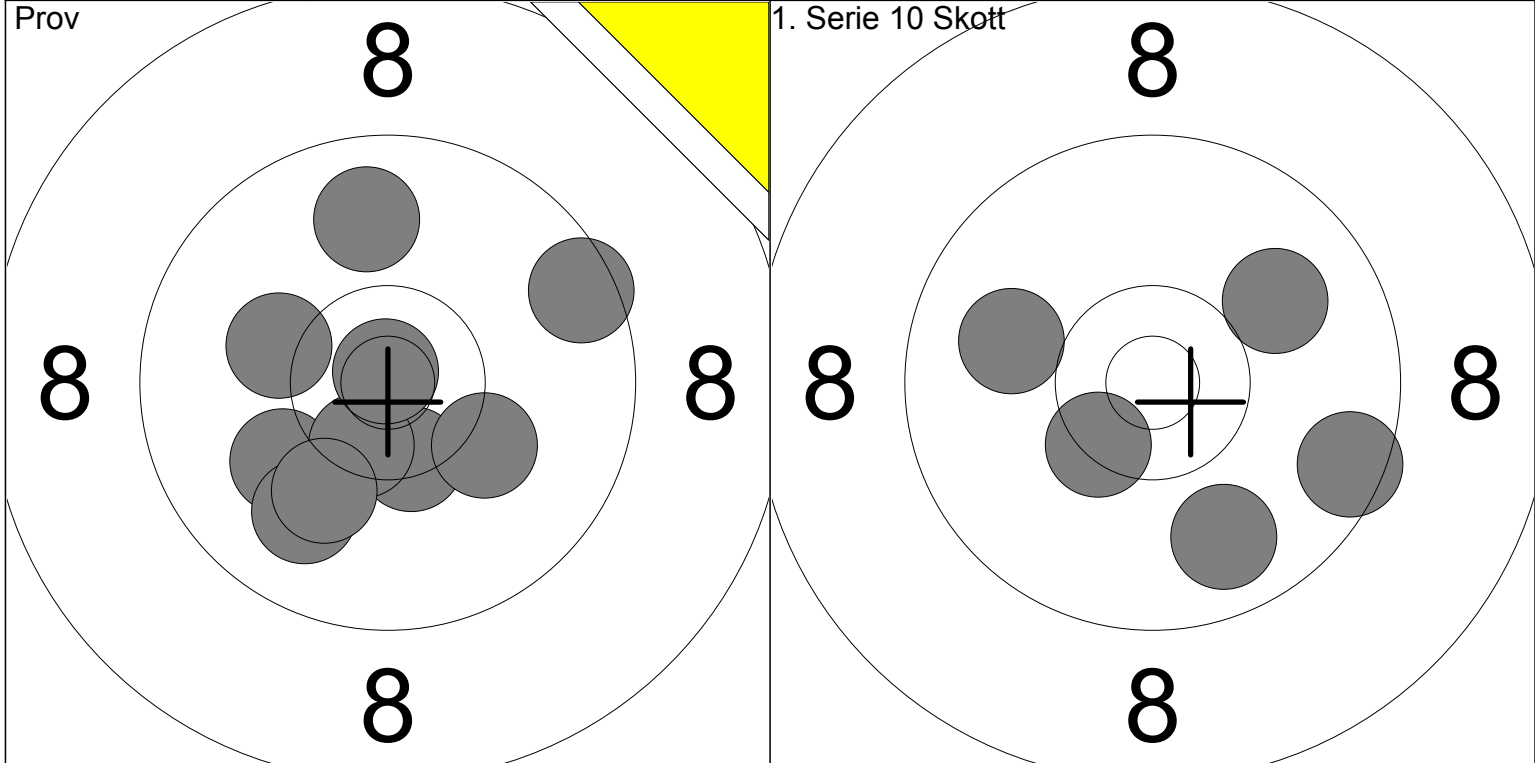

1: 10.1 ↙	6: 10.5x ↓		1: 9.5 →	
2: 10.4x ↓	7: 10.2 →	Serie	2: 10.0 ↗	48
3: 9.9 ↙	8: 10.2 ←	Total	3: 10.4x ↙	239
4: 9.5 →	9: 10.9x ↑	97	4: 10.0 ←	
5: 9.9 ↑	10: 10.1 ↓	191	5: 9.8 ↓	

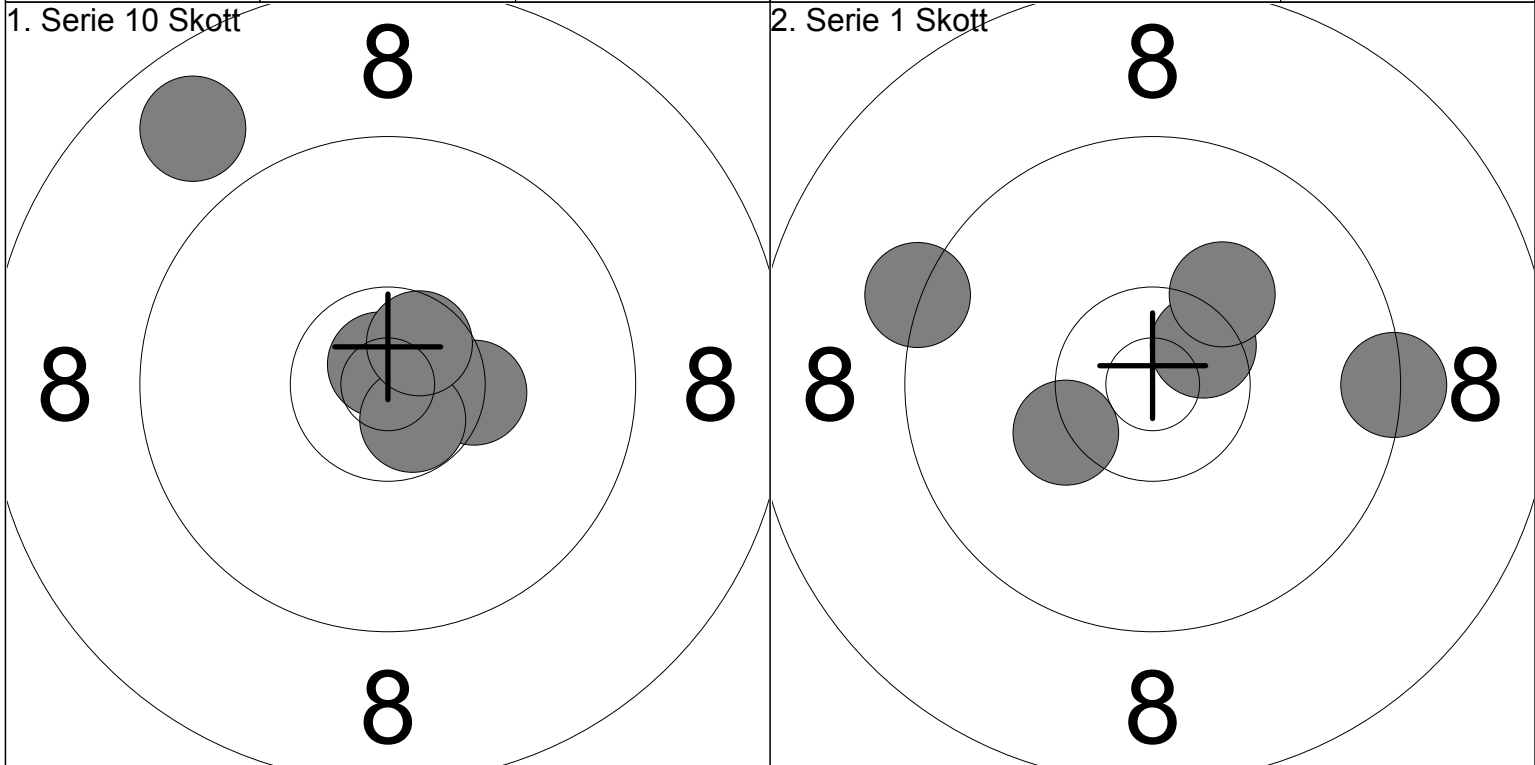

6: 8.8 ↗			1: 10.3 ↙	
7: 10.4x →	8: 10.8x ↗	Serie	2: 10.5x ↗	48
9: 10.7x ↓	10: 10.6x ↗	Total	3: 9.3 →	335
		287	4: 9.3 ←	
			5: 10.2 ↗	

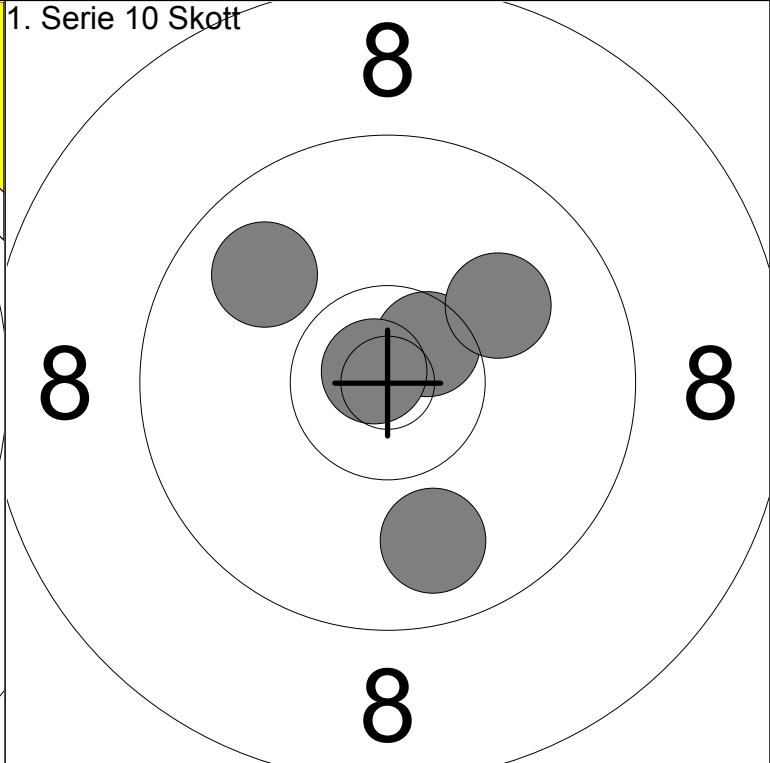
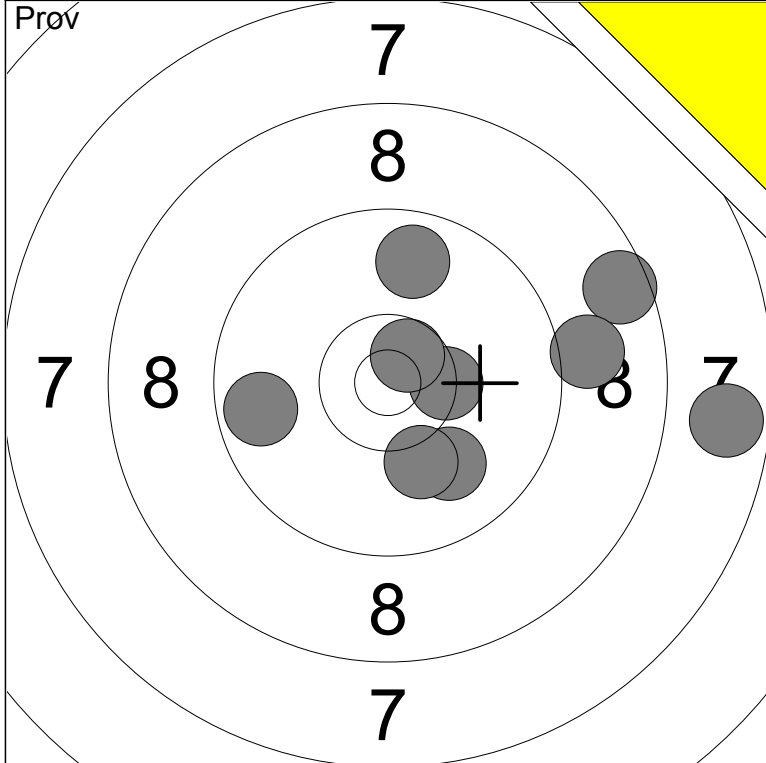

1: 8.6 →	6: 10.4x →	Serie	82
2: 10.0 ↓	7: 10.1 ↓		
3: 7.7 →	8: 10.6x ↗	Total	190
4: 9.0 →	9: 9.8 ↑		
5: 9.7 ←			

1: 9.9 ↖	Serie	48
2: 10.6x ↗		
3: 10.1 ↗	Total	238
4: 9.9 ↓		
5: 10.8x ↖		

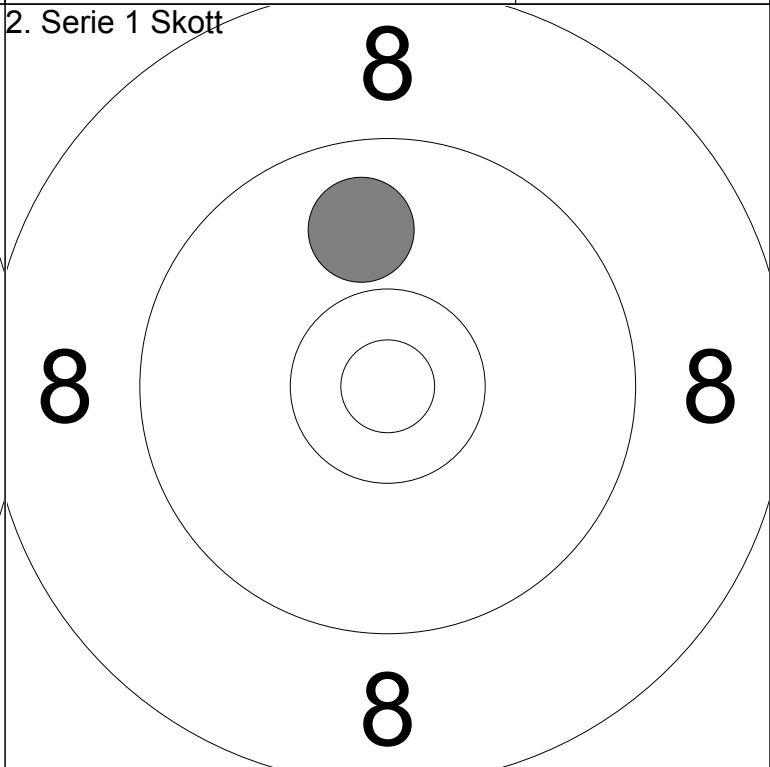
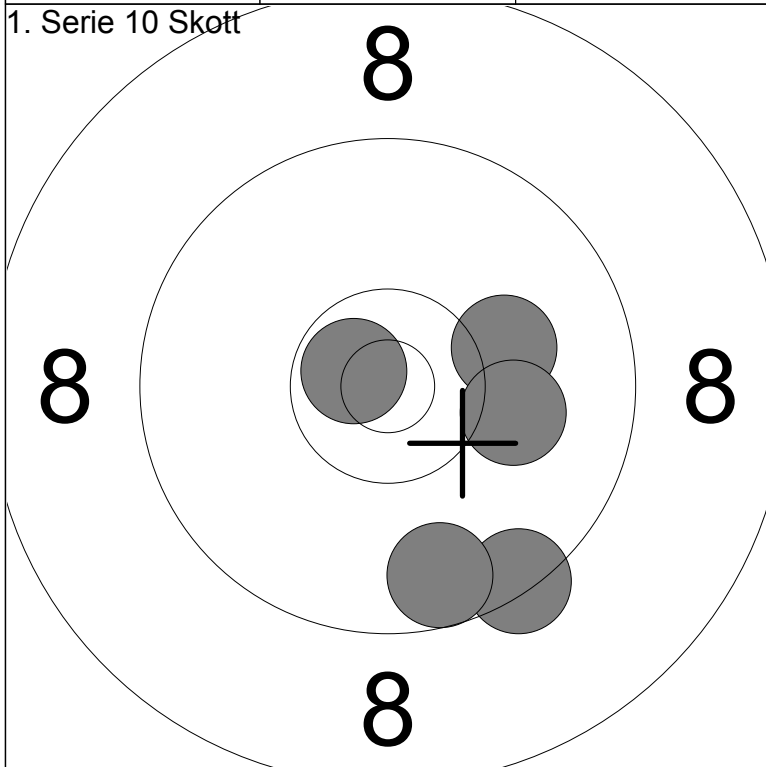

6: 10.1 →	Serie	48
7: 10.7x ↖		
8: 9.4 ↓	Total	286
9: 10.1 →		
10: 9.6 ↓		

1: 9.9 ↑	Serie	9
	Total	295

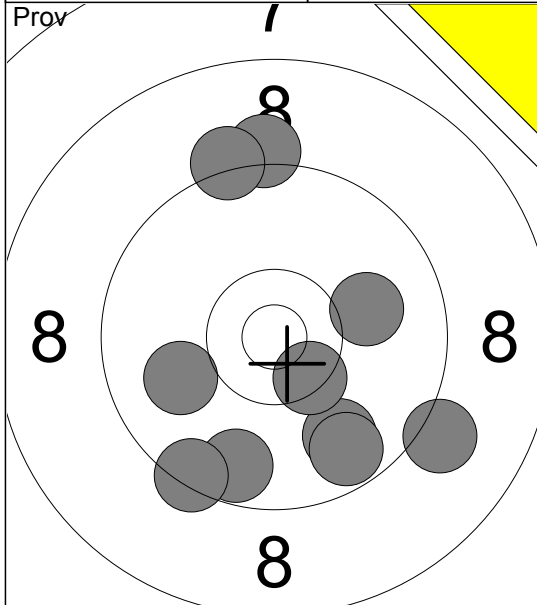

- 1: 9.1 ↘
- 2: 9.7 ↓
- 3: 9.4 ↙
- 4: 9.2 ↑
- 5: 10.0 →
- 6: 9.2 ↑
- 7: 10.0 ←
- 8: 9.8 ↓
- 9: 10.4x ↘
- 10: 9.7 ↓

Serie 93.0
Total 190.0

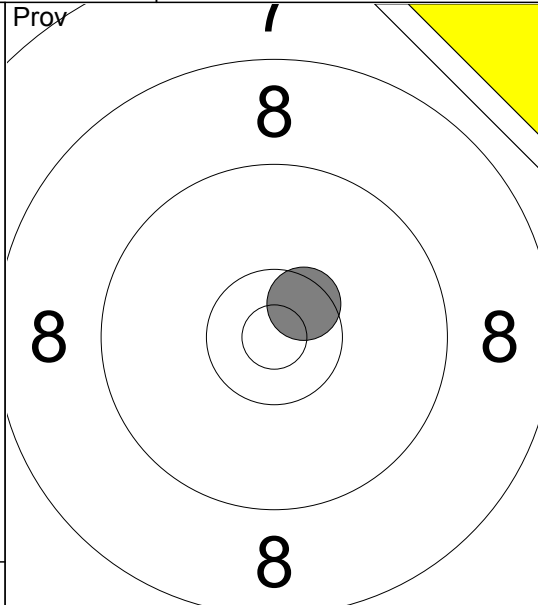

11: 10.5x ↗

Serie 10.0
Total 190.0

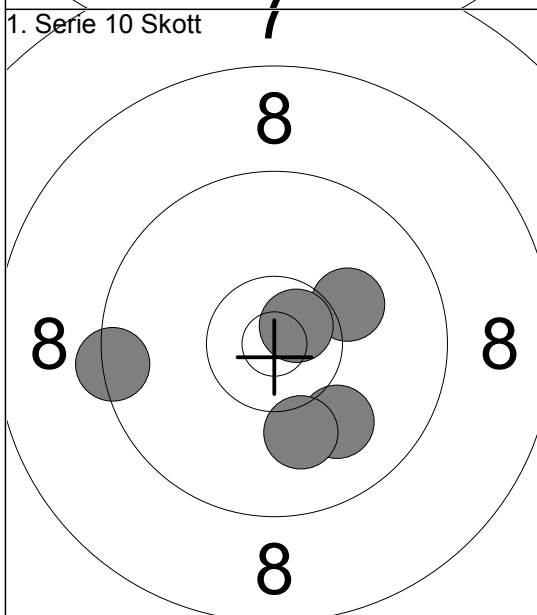

- 1: 10.2 ↗
- 2: 10.7x ↗
- 3: 9.4 ←
- 4: 10.0 ↓
- 5: 10.1 ↓

Serie 49.0
Total 239.0

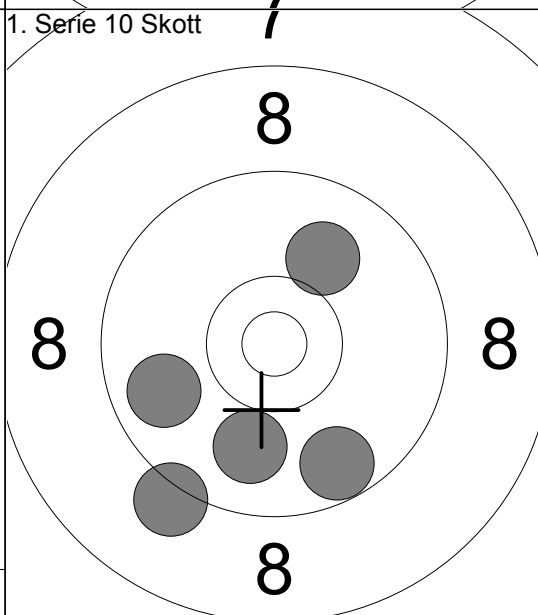

- 6: 10.0 ↗
- 7: 9.8 ←
- 8: 9.2 ↓
- 9: 9.7 ↓
- 10: 9.9 ↓

Serie 46.0
Total 285.0

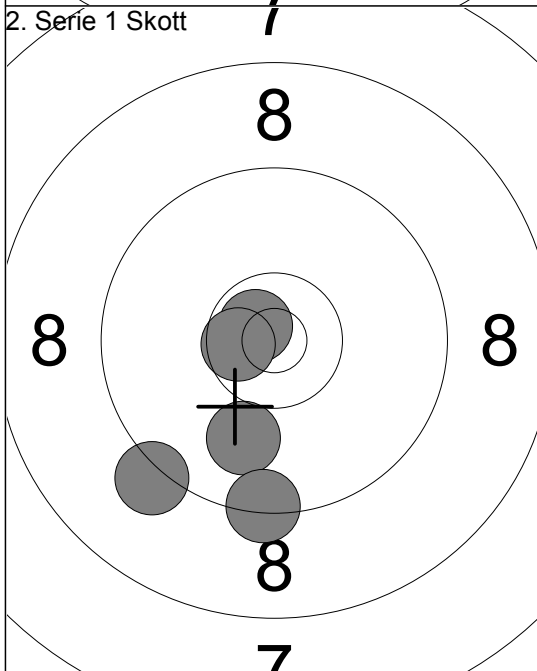

- 1: 9.2 ↙
- 2: 10.0 ↓
- 3: 9.4 ↓
- 4: 10.7x ↘
- 5: 10.6x ↘

Serie 48.0
Total 333.0

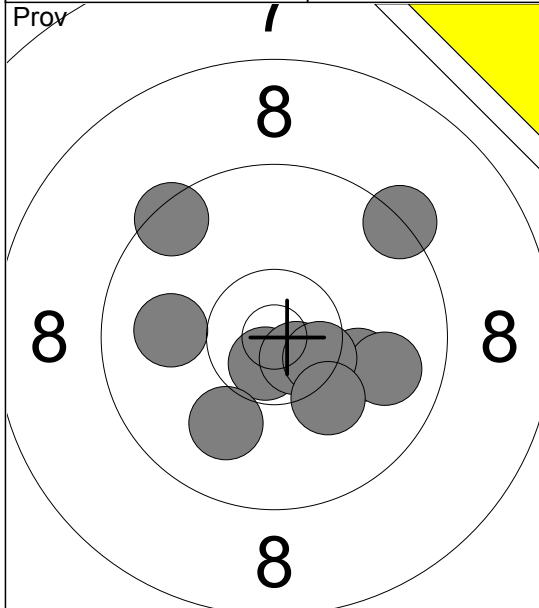

- 1: 10.7x ↘
- 2: 10.0 ↘
- 3: 10.1 →
- 4: 10.7x ↘
- 5: 9.5 ↗
- 6: 10.0 ←
- 7: 9.9 →
- 8: 10.5x ↘
- 9: 9.3 ↗
- 10: 10.2 ↘

Serie 97.0
Total 189.0

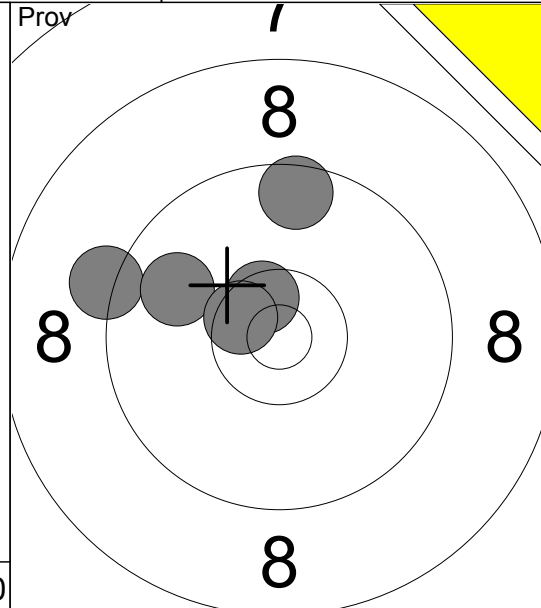

- 11: 9.2 ←
- 12: 9.9 ←
- 13: 10.5x ↗
- 14: 9.6 ↑
- 15: 10.5x ↘

Serie 47.0
Total 189.0

1. Serie 10 Skott

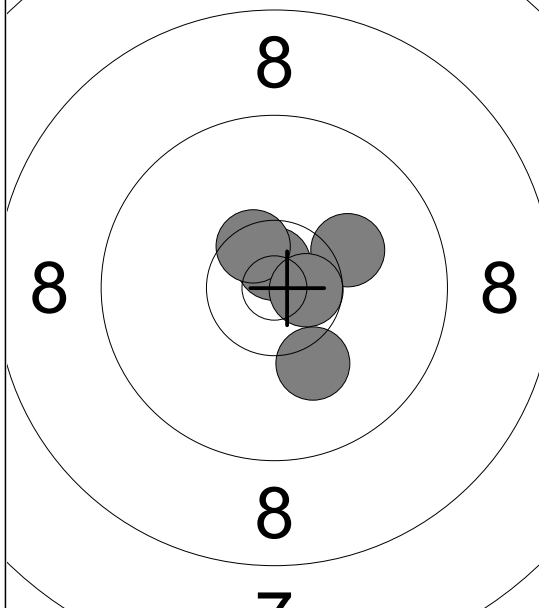

- 1: 10.1 ↘
- 2: 10.7x ↗
- 3: 10.2 ↗
- 4: 10.5x ↗
- 5: 10.6x →

Serie 50.0
Total 239.0

1. Serie 10 Skott

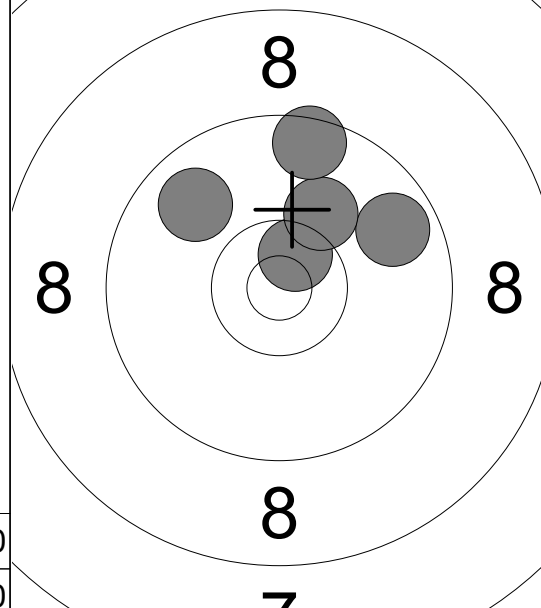

- 6: 9.7 ↗
- 7: 9.8 ↖
- 8: 10.6x ↗
- 9: 10.1 ↗
- 10: 9.5 ↑

Serie 47.0
Total 286.0

2. Serie 1 Skott

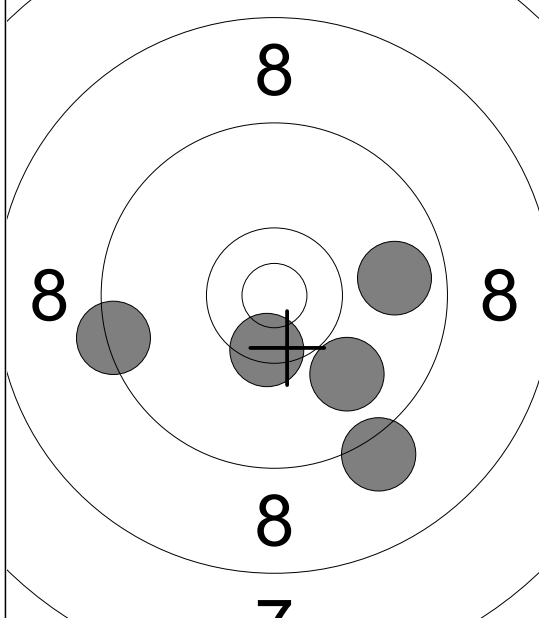

- 1: 9.1 ↘
- 2: 9.8 →
- 3: 10.4x ↘
- 4: 9.4 ←
- 5: 9.9 ↘

Serie 46.0
Total 332.0

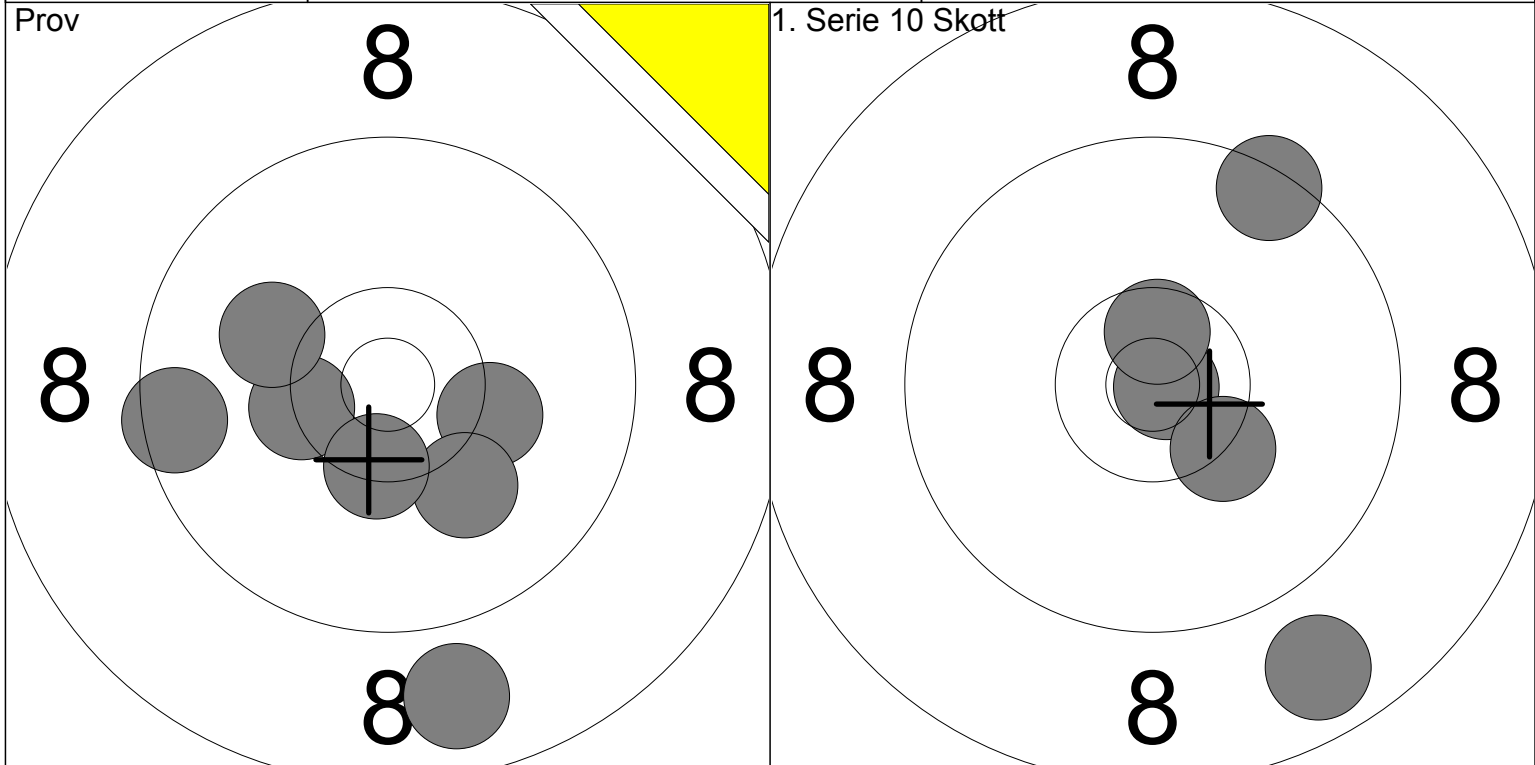

1: 9.5 ←	6: 10.4x ↓		1: 10.9x →	
2: 8.8 ↓	7: 10.1 ←	Serie	2: 8.8 ↓	Serie
3: 10.2 →			3: 10.6x ↑	
4: 10.4x ←		Total	4: 10.3x ↓	Total
5: 10.1 ↓		67	5: 9.4 ↗	47
		187		234

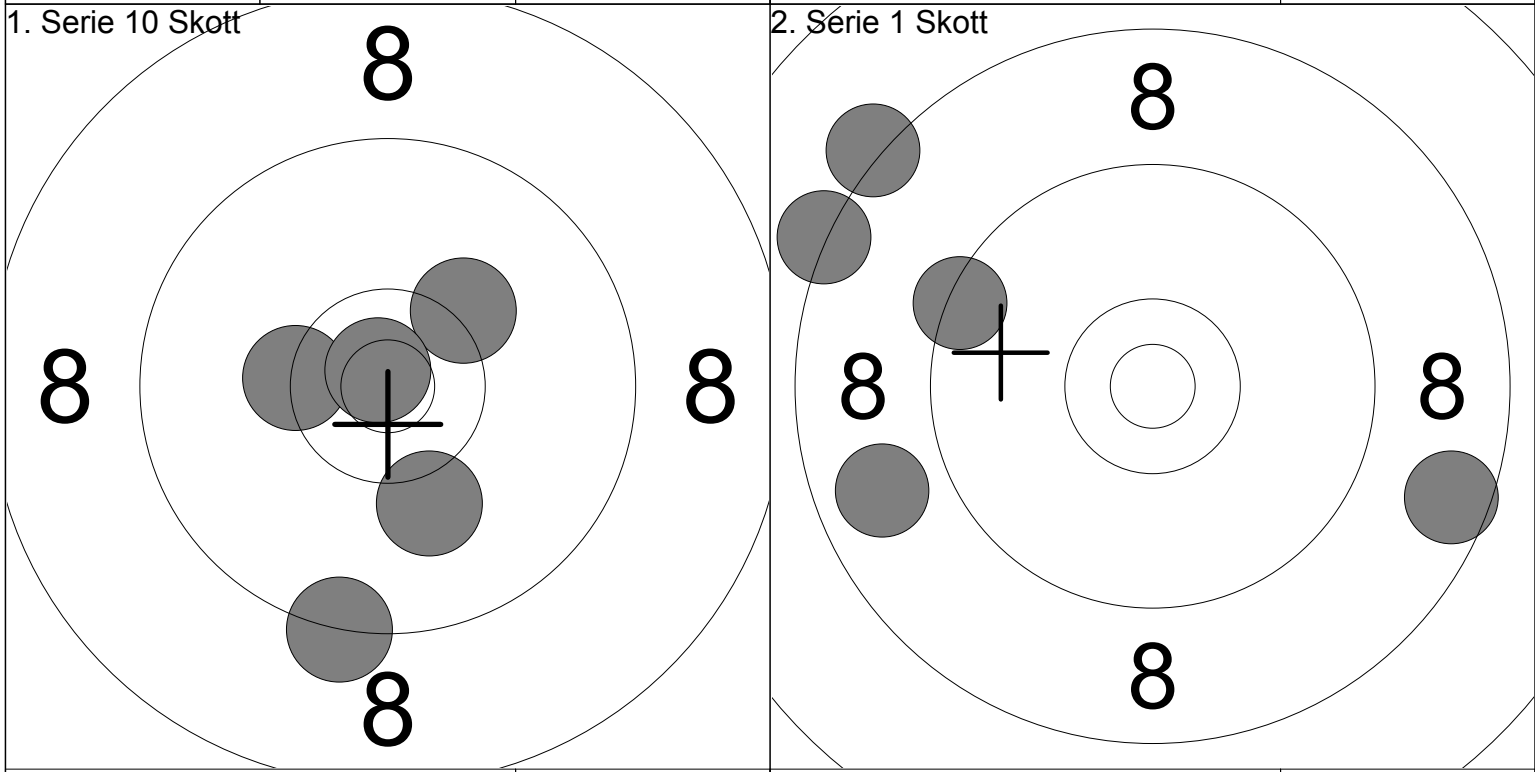

6: 10.1 ↓	1: 8.3 ↖		2: 8.2 ↗	
7: 10.2 ↗		Serie	3: 8.6 ↘	Serie
8: 10.3x ←			4: 9.4 ↖	
9: 9.3 ↓		Total	5: 8.8 ←	Total
10: 10.8x ↗		49		41
		283		324

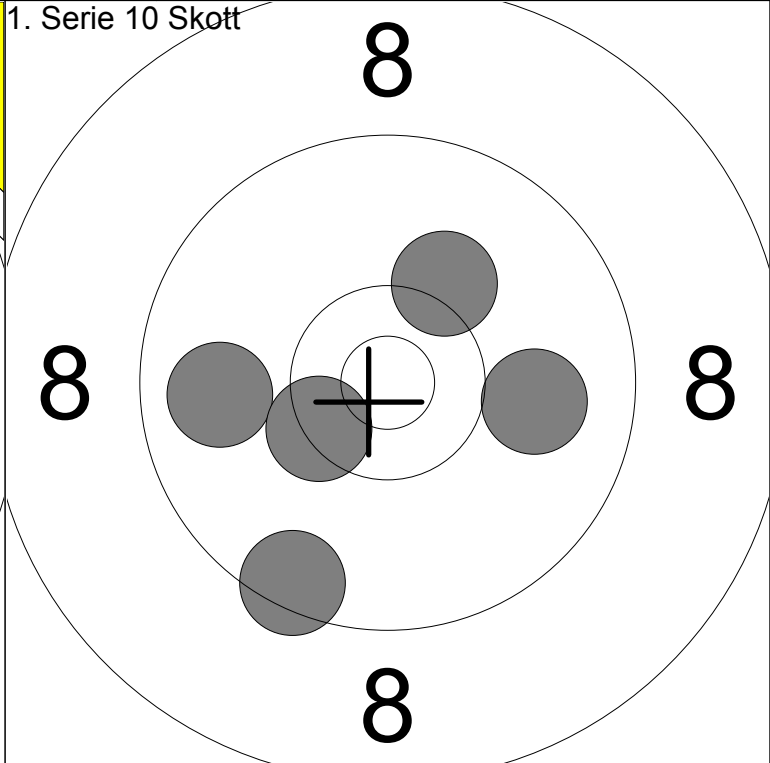
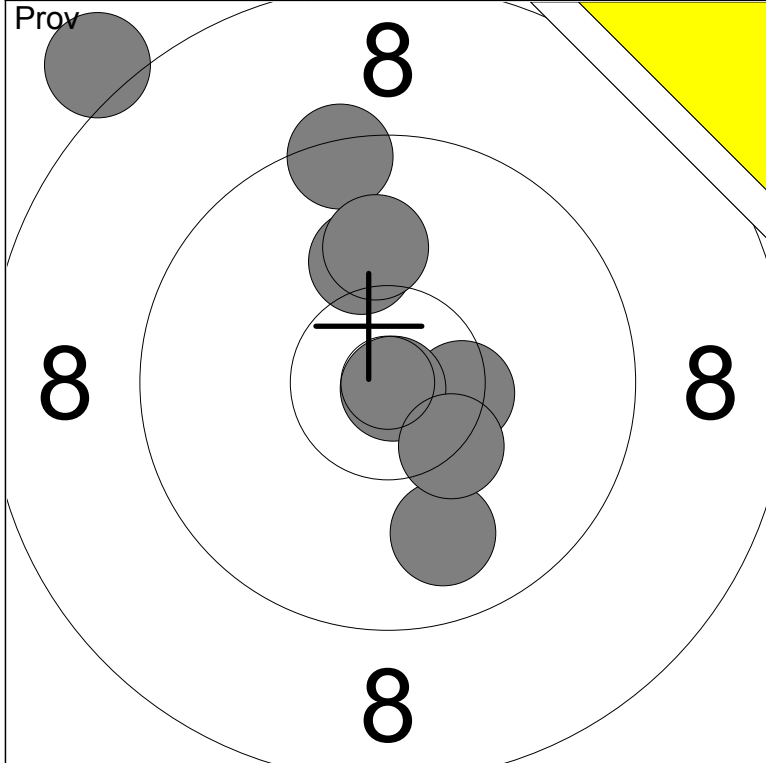

1: 9.9 ↓ 2: 10.5x → 3: 10.1 ↑ 4: 8.1 ↗ 5: 9.4 ↑	6: 10.9x ↓ 7: 10.4x ↓ 8: 10.0 ↑	Serie 76 <hr/> Total 187
--	--	---

1: 10.0 → 2: 9.8 ← 3: 9.5 ↓ 4: 10.2 ↗ 5: 10.4x ↙	Serie 48 <hr/> Total 235
---	---

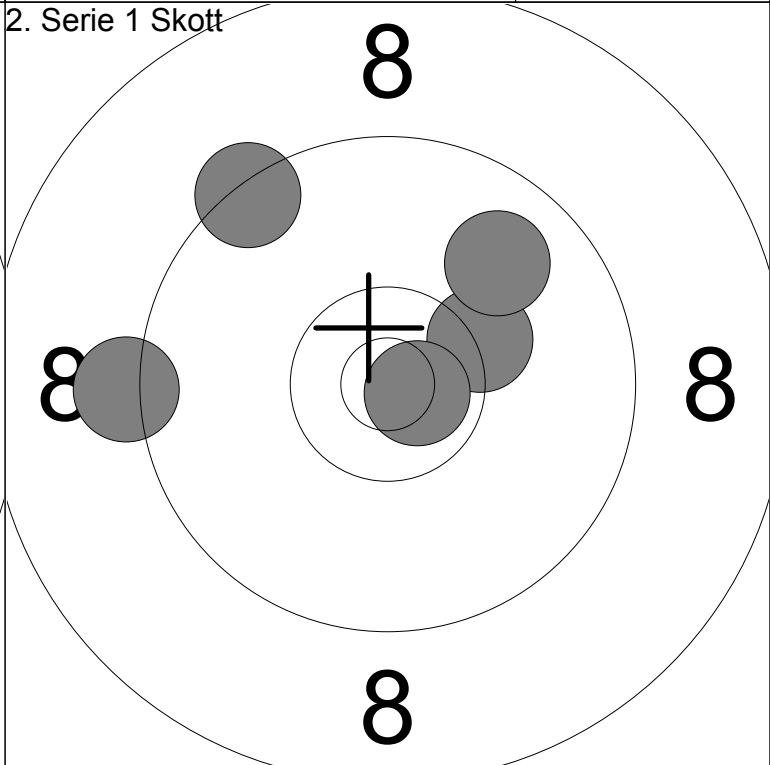
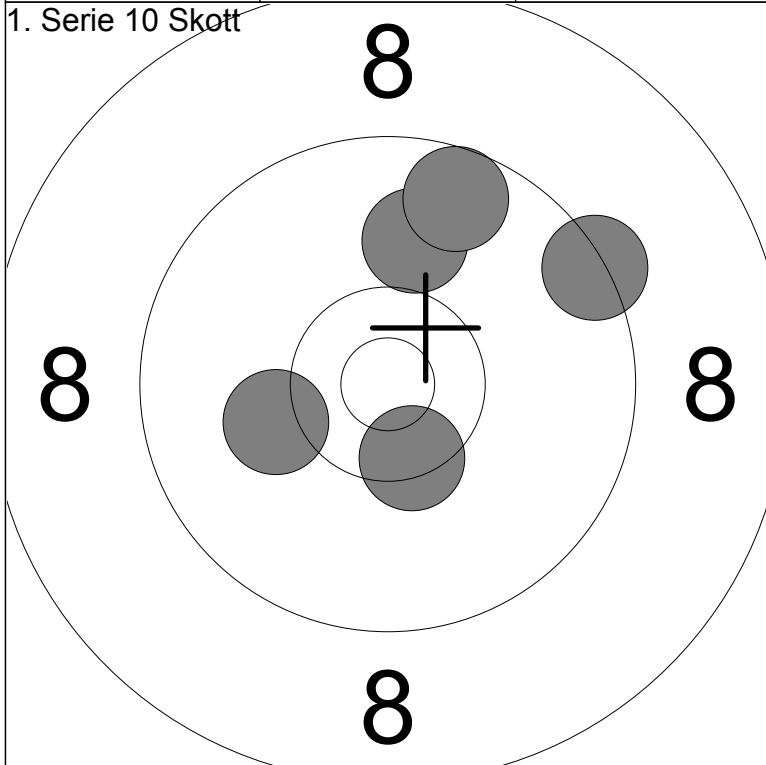

6: 10.0 ↑ 7: 9.6 ↑ 8: 10.4x ↓ 9: 9.4 ↗ 10: 10.2 ←	Serie 48 <hr/> Total 283
--	---

1: 9.2 ← 2: 10.3 → 3: 9.4 ↗ 4: 9.9 ↗ 5: 10.7x →	Serie 47 <hr/> Total 330
--	---

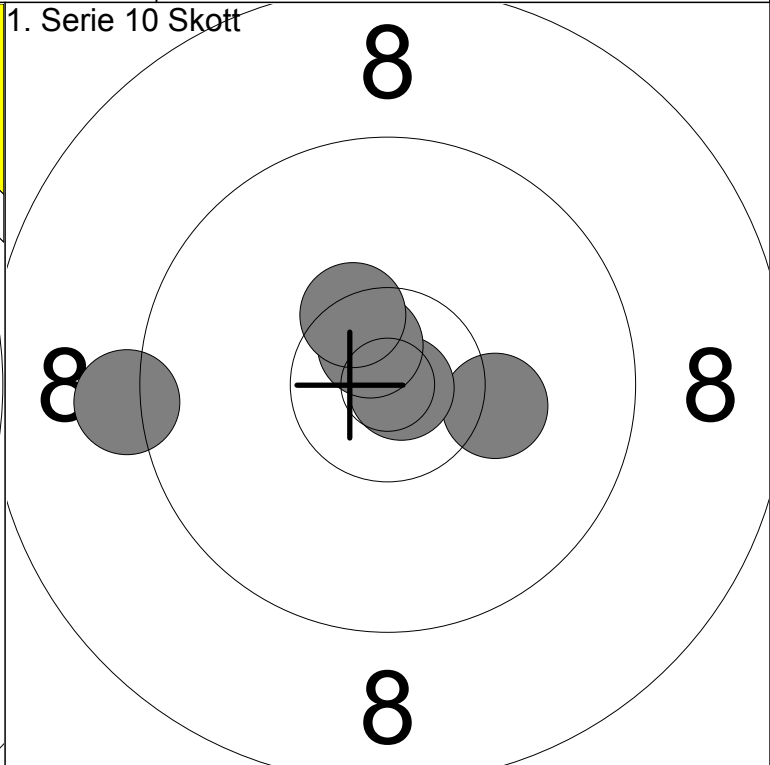
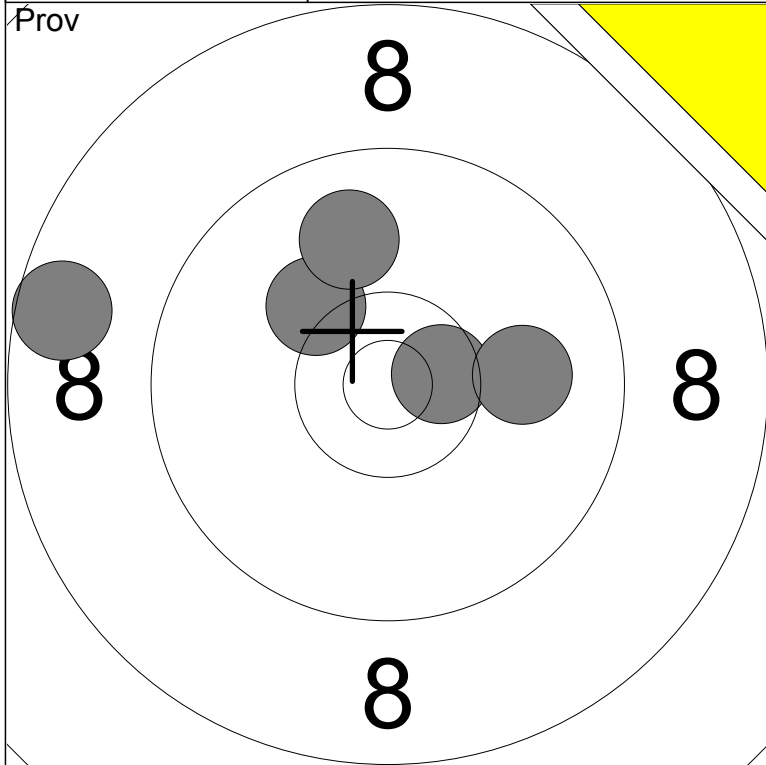

1:	10.6x	→
2:	10.0	→
3:	10.2	↗
4:	8.6	←
5:	9.9	↑

Serie	47
Total	183

1:	10.2	→
2:	9.2	←
3:	10.9x	→
4:	10.7x	↗
5:	10.4x	↗

Serie	49
Total	232

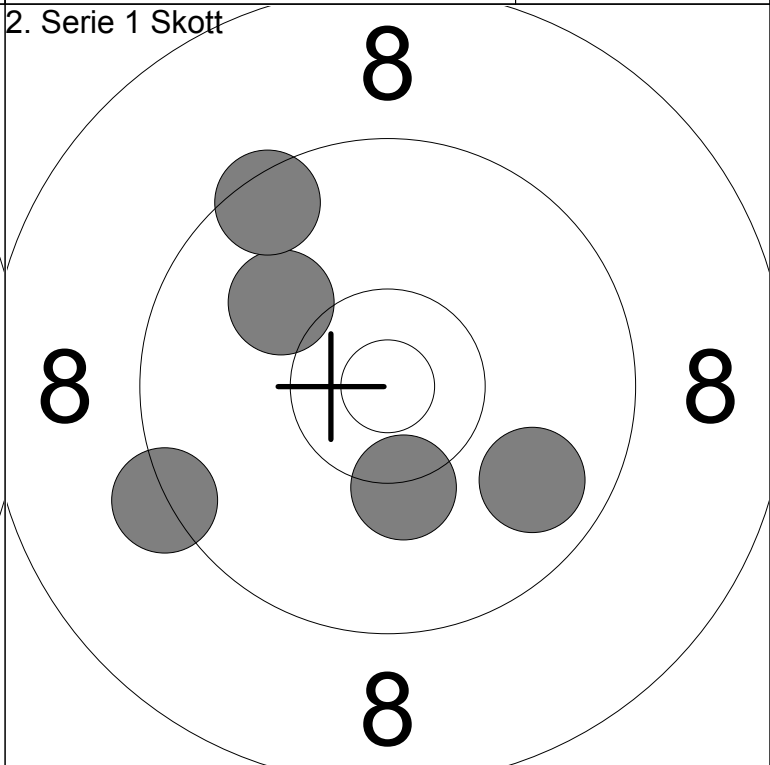
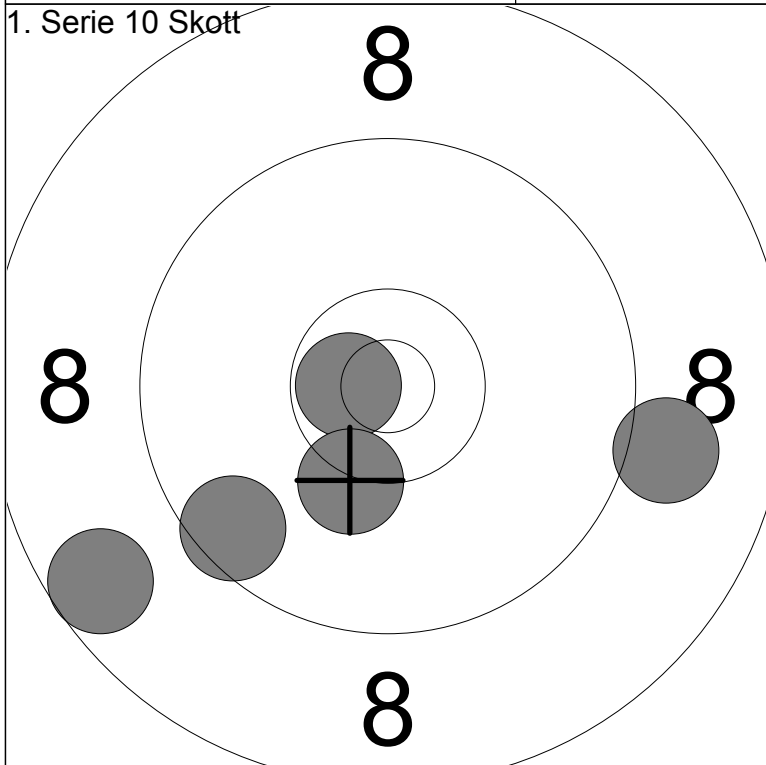

6:	9.5	↖
7:	10.7x	←
8:	10.3	↓
9:	9.1	→
10:	8.6	↖

Serie	46
Total	278

1:	9.8	↘
2:	9.3	↖
3:	10.3	↓
4:	10.0	↗
5:	9.5	↗

Serie	47
Total	325

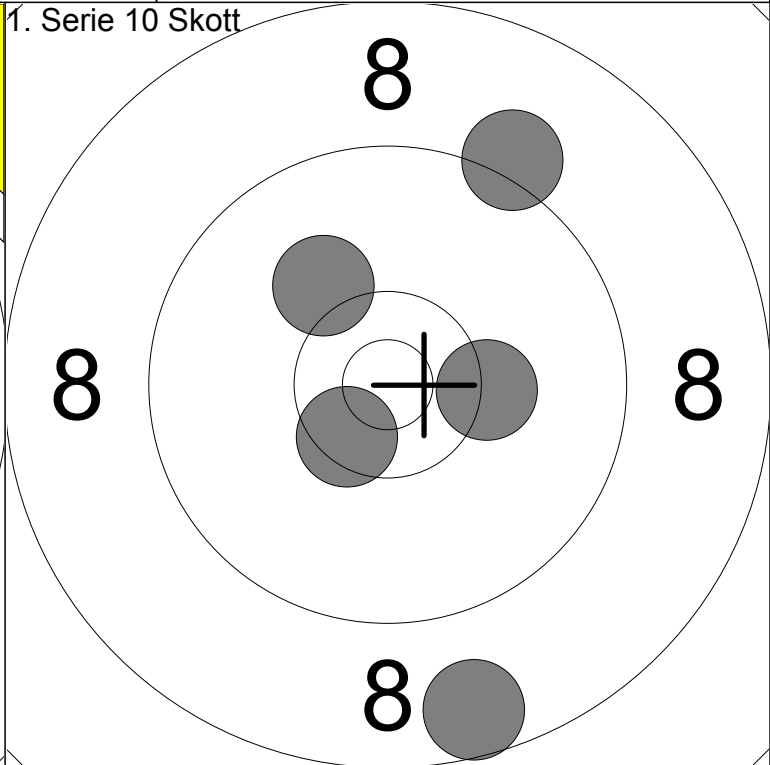
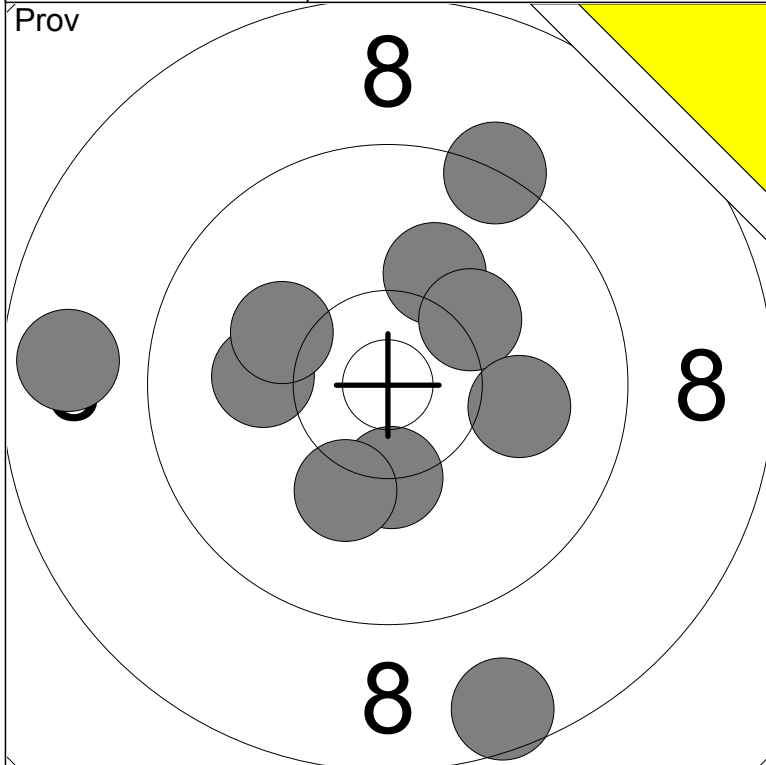

1: 8.8 ←	6: 10.3x ↓	Serie	95
2: 10.1 ↗	7: 10.1 ←		
3: 9.3 ↗	8: 10.1 ↖	Total	180
4: 10.2 ↗	9: 10.2 ↓		
5: 8.6 ↓	10: 10.0 →		

1: 8.6 ↓	Serie	47
2: 10.3 →		
3: 10.1 ↗	Total	227
4: 9.2 ↗		
5: 10.5x ↓		

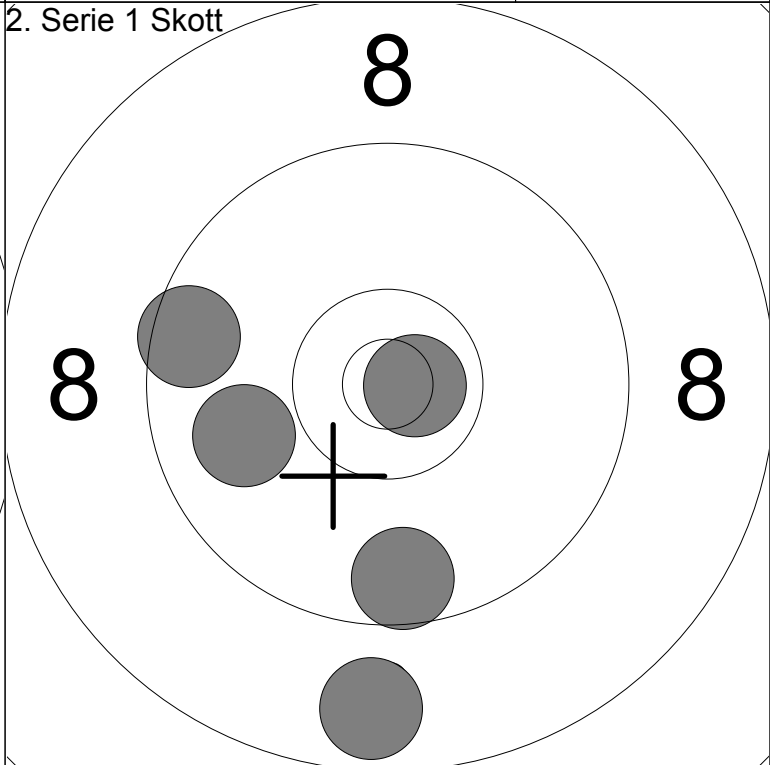
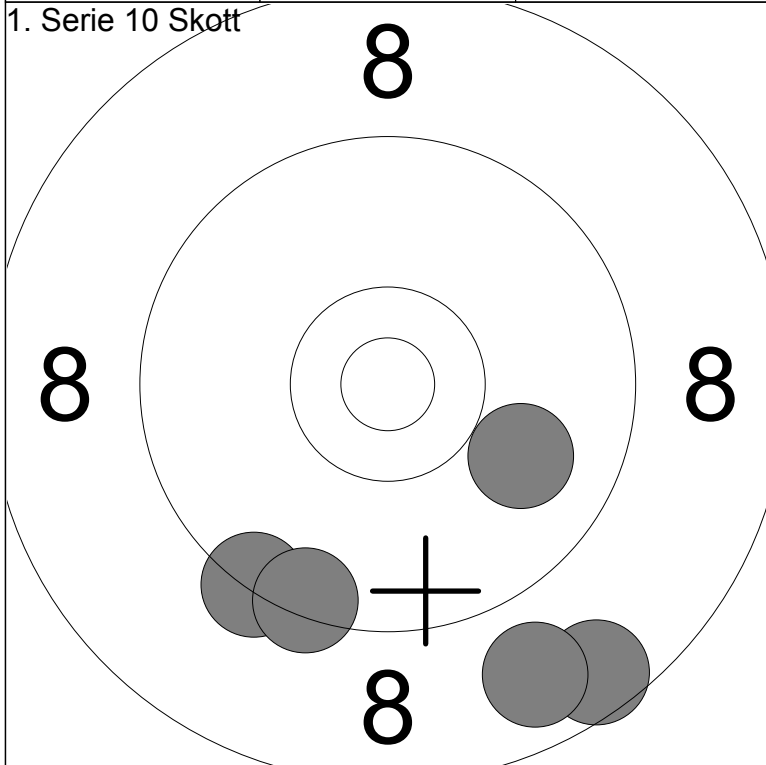

6: 8.6 ↓	Serie	43
7: 8.8 ↓		
8: 9.3 ↓	Total	270
9: 9.9 ↓		
10: 9.4 ↓		

1: 9.9 ↖	Serie	45
2: 10.8x →		
3: 9.5 ↖	Total	315
4: 9.6 ↓		
5: 8.7 ↓		

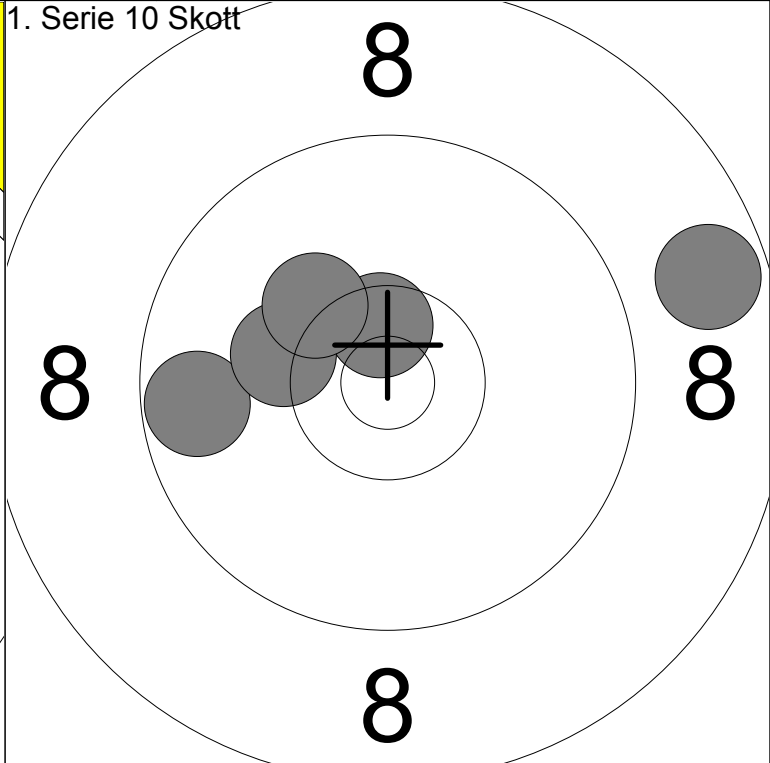
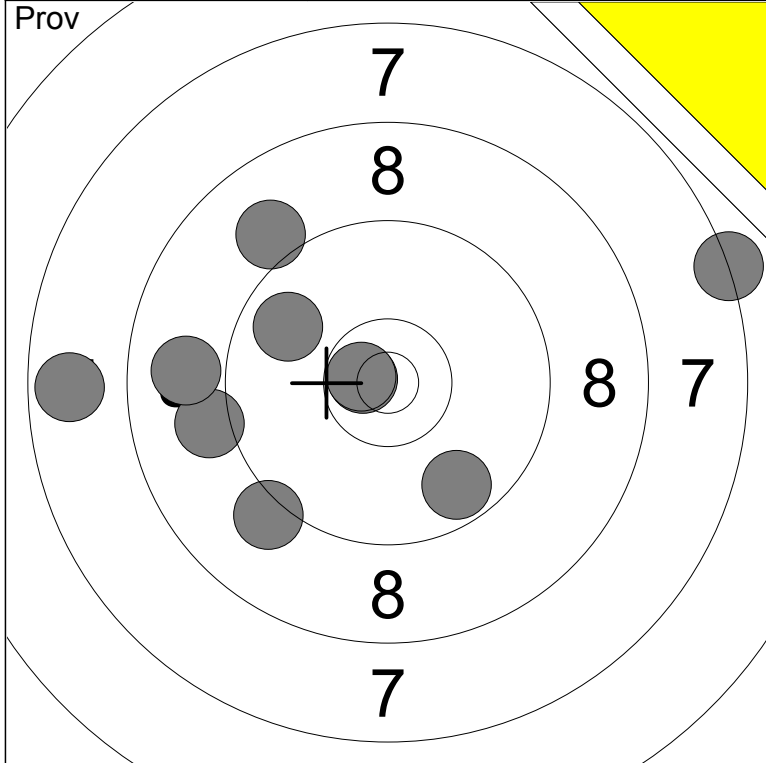

1: 9.1 ←	6: 10.7x ←	Serie	87
2: 10.7x ←	7: 7.3 →		
3: 7.7 ←	8: 9.7 ↘	Total	176
4: 9.1 ↙	9: 9.0 ↗		
5: 9.8 ←	10: 8.9 ←		

1: 8.7 →	Serie	47
2: 10.6x ↑		
3: 9.7 ←	Total	223
4: 10.2 ←		
5: 10.2 ↘		

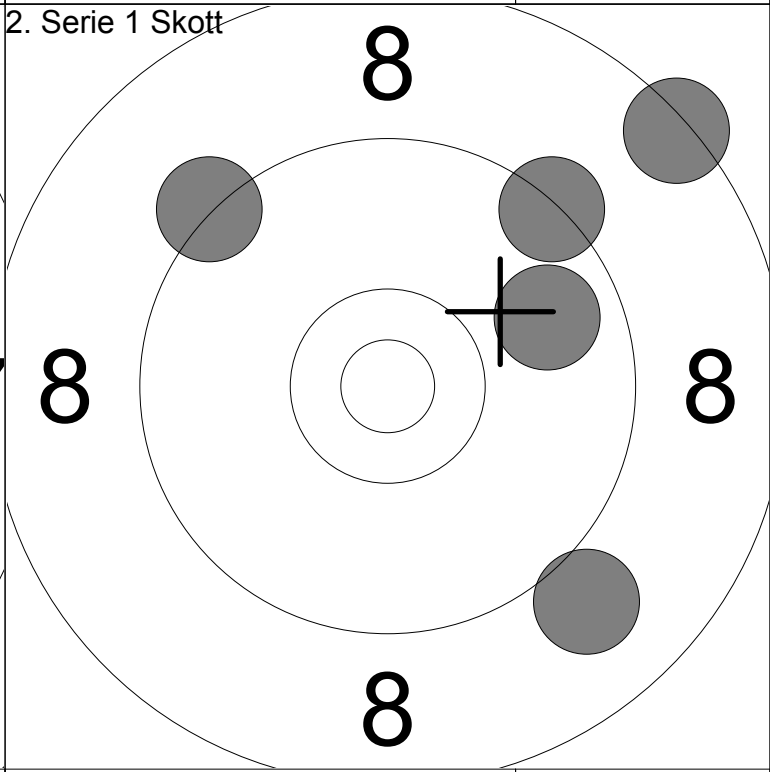
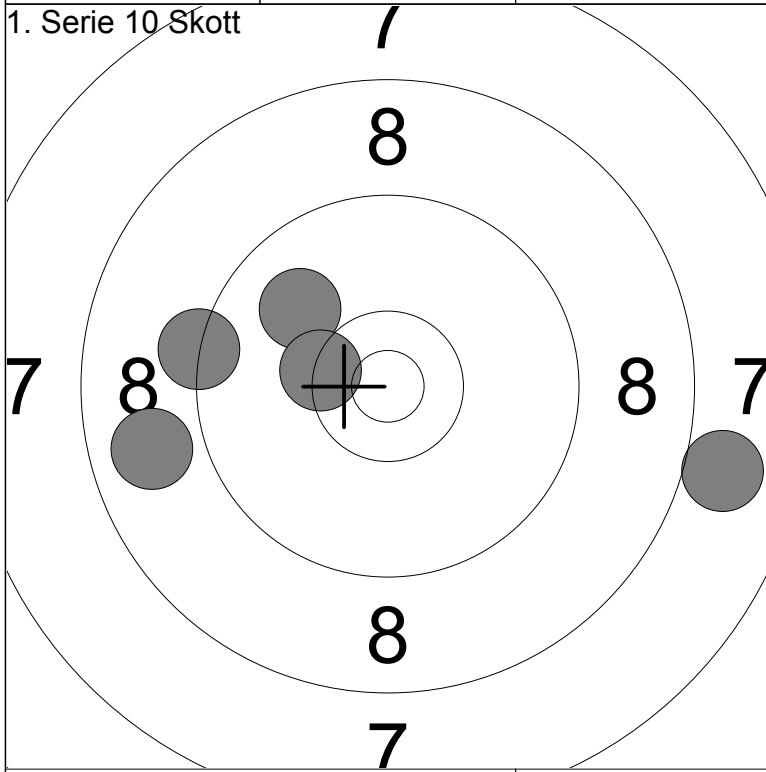

6: 9.3 ←	Serie	44
7: 8.8 ←		
8: 8.0 →	Total	267
9: 9.9 ↗		
10: 10.4x ←		

1: 8.4 ↗	Serie	44
2: 9.8 →		
3: 9.3 ↗	Total	311
4: 9.3 ↗		
5: 9.0 ↘		

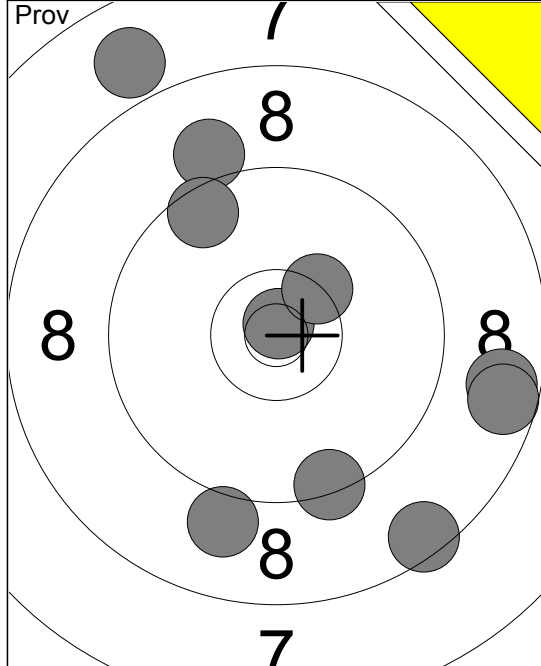

1:	10.8x ↗
2:	8.5 ↘
3:	8.7 →
4:	9.1 ↗
5:	9.4 ↘
6:	9.0 ↘
7:	8.6 →
8:	9.5 ↗
9:	7.9 ↗
10:	10.3x ↗

Serie	87.0
Total	172.0

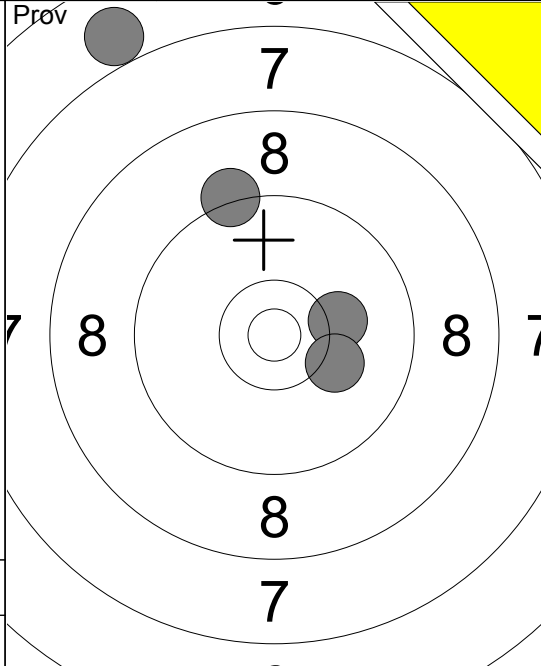

11:	10.2 →
12:	9.2 ↗
13:	6.9 ↗
14:	10.2 ↘

Serie	35.0
Total	172.0

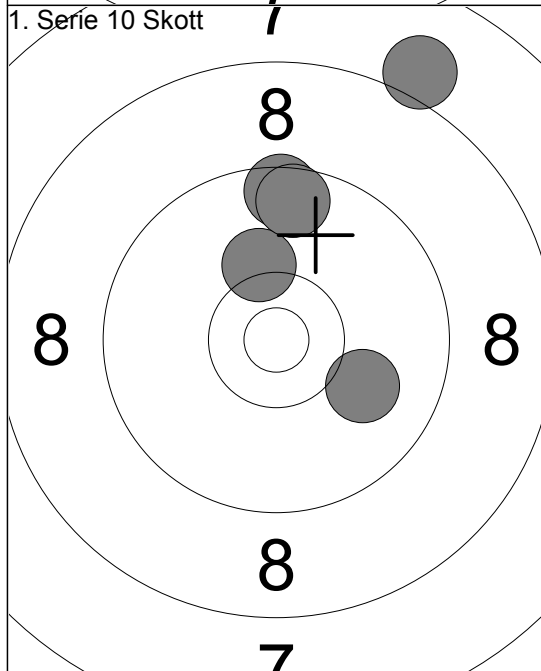

1:	8.1 ↗
2:	9.5 ↗
3:	10.0 ↘
4:	10.2 ↗
5:	9.6 ↗

Serie	46.0
Total	218.0

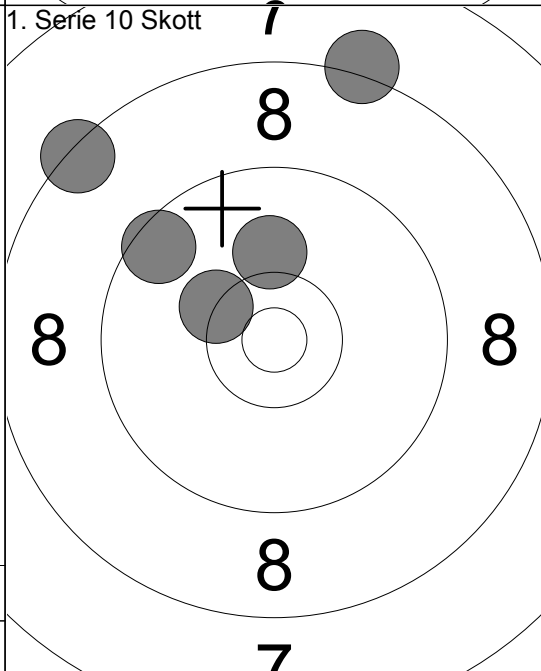

6:	10.3x ↘
7:	8.4 ↘
8:	10.1 ↗
9:	8.2 ↗
10:	9.5 ↘

Serie	45.0
Total	263.0

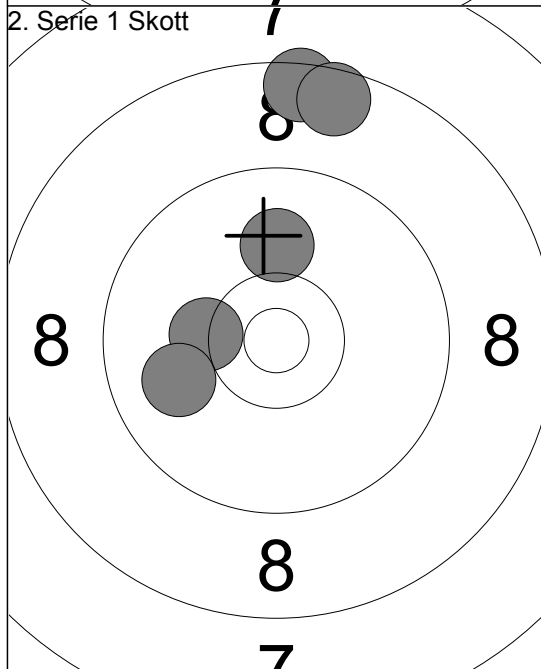

1:	8.5 ↗
2:	8.6 ↗
3:	10.0 ↗
4:	10.3 ←
5:	9.9 ←

Serie	45.0
Total	308.0

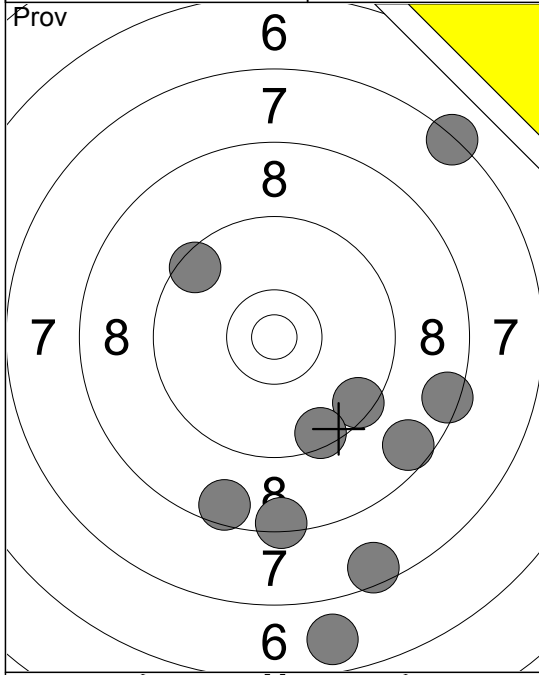

1:	7.3	↗
2:	9.5	↘
3:	9.5	↗
4:	7.5	↘
5:	8.4	↘
6:	8.6	↘
7:	8.6	↘
8:	9.5	↘
9:	8.5	→
10:	6.8	↘
Serie		79.0
Total		167.0

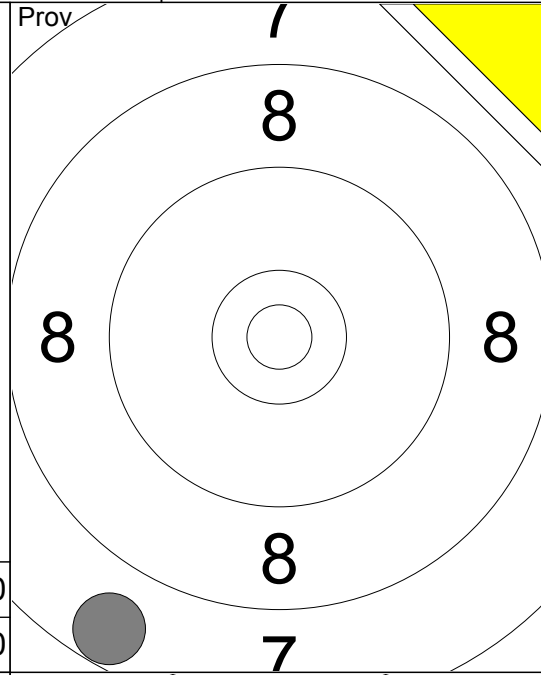

11:	7.7	↘
Serie		7.0
Total		167.0

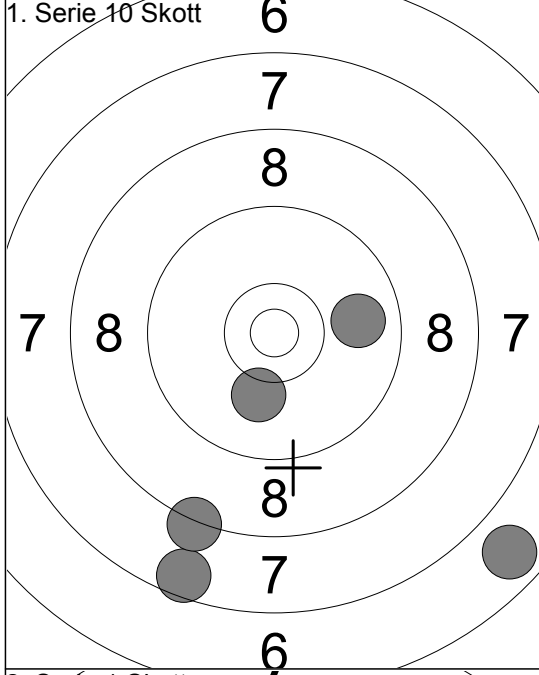

1:	9.9	→
2:	6.8	↘
3:	10.1	↘
4:	7.6	↘
5:	8.3	↘
Serie		40.0
Total		207.0

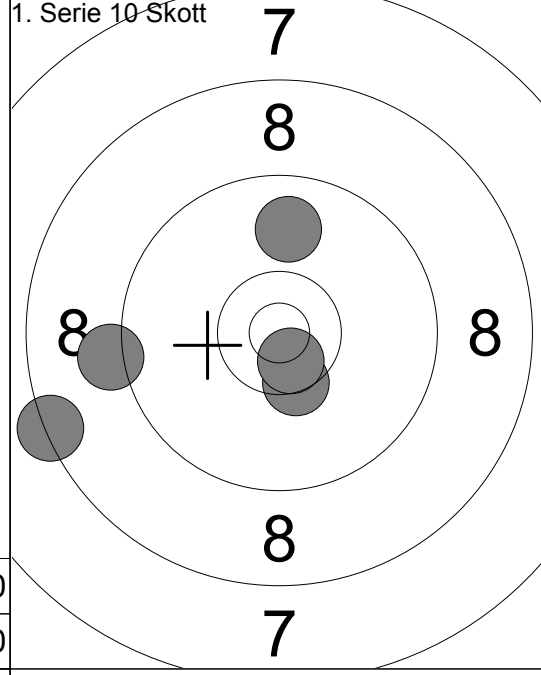

6:	9.9	↑
7:	10.4	↘
8:	9.2	←
9:	10.6	↘
10:	8.4	←
Serie		46.0
Total		253.0

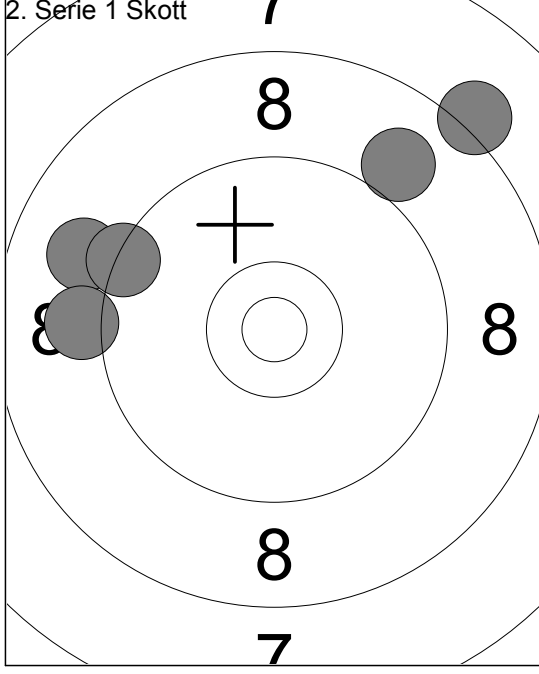

1:	9.0	↗
2:	9.0	←
3:	8.2	↗
4:	9.4	←
5:	9.1	←
Serie		44.0
Total		297.0

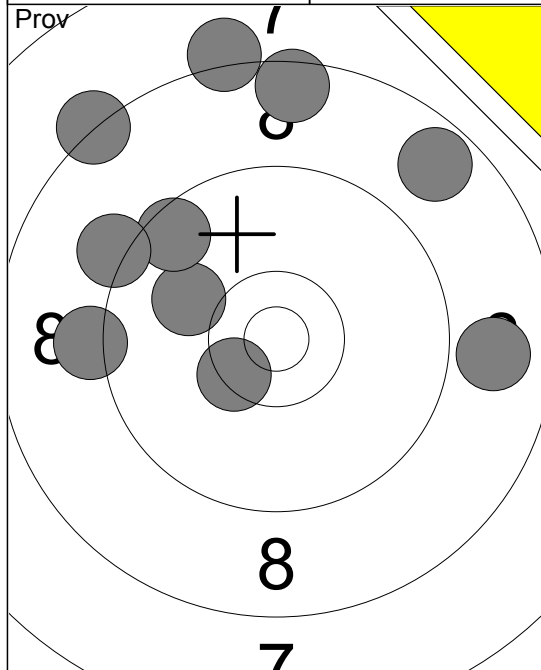

1:	8.3	↖
2:	8.5	↑
3:	10.0	↖
4:	9.6	↖
5:	9.2	↖
6:	10.4	↘
7:	9.2	←
8:	8.7	↗
9:	8.9	→
10:	8.2	↑
Serie	87.0	
Total	195.0	

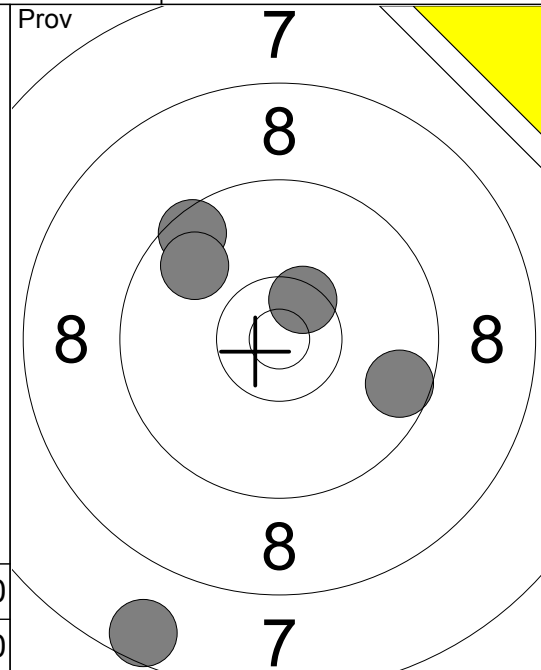

11:	9.5	↖
12:	9.8	↖
13:	10.5	↗
14:	7.6	↘
15:	9.6	→
Serie	44.0	
Total	195.0	

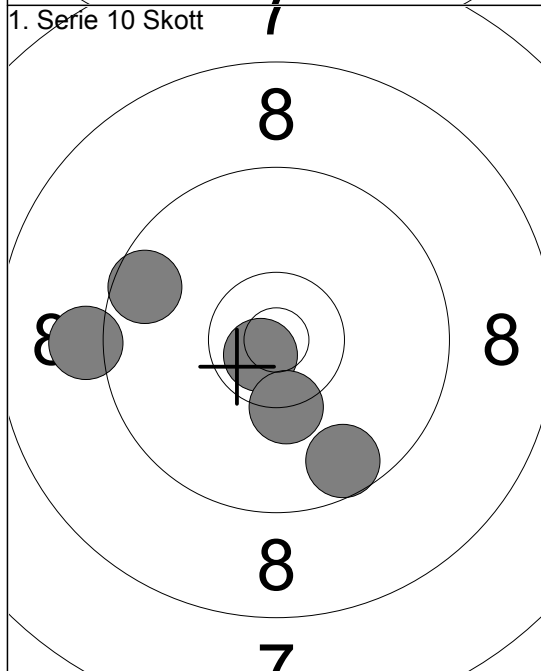

1:	9.6	↘
2:	10.7	↘
3:	9.1	←
4:	9.6	←
5:	10.3	↘
Serie	47.0	
Total	242.0	

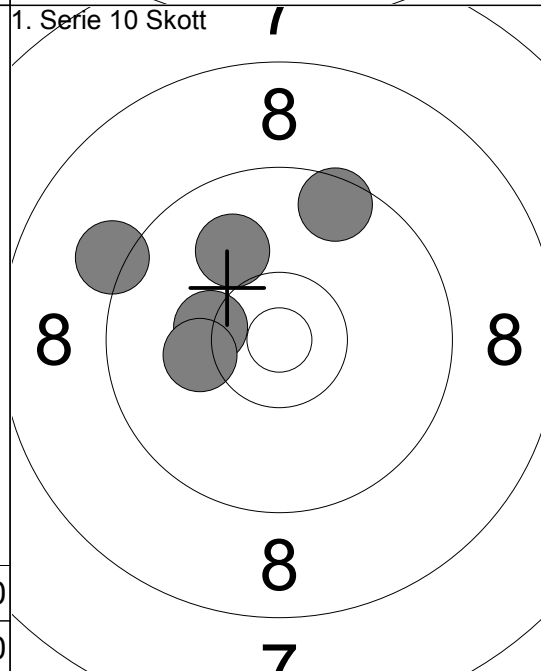

6:	10.0	↖
7:	9.6	↗
8:	9.2	↖
9:	10.3	↖
10:	10.2	↖
Serie	48.0	
Total	290.0	

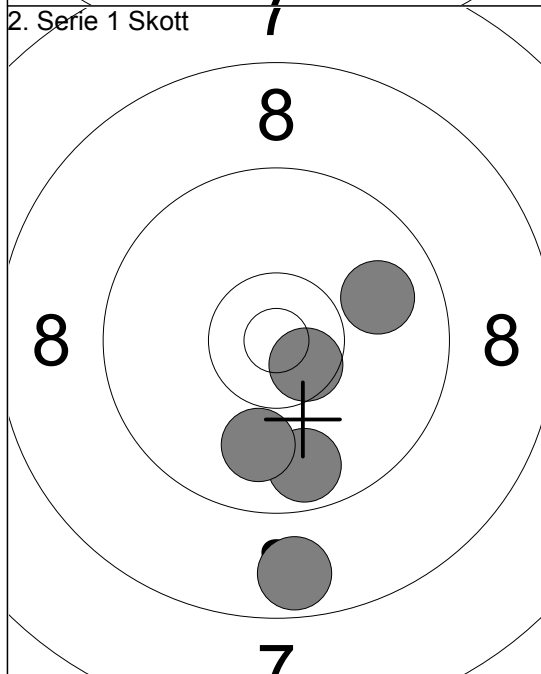

1:	8.7	↓
2:	9.7	↓
3:	9.9	↓
4:	10.6	↘
5:	9.9	→
Serie	45.0	
Total	335.0	

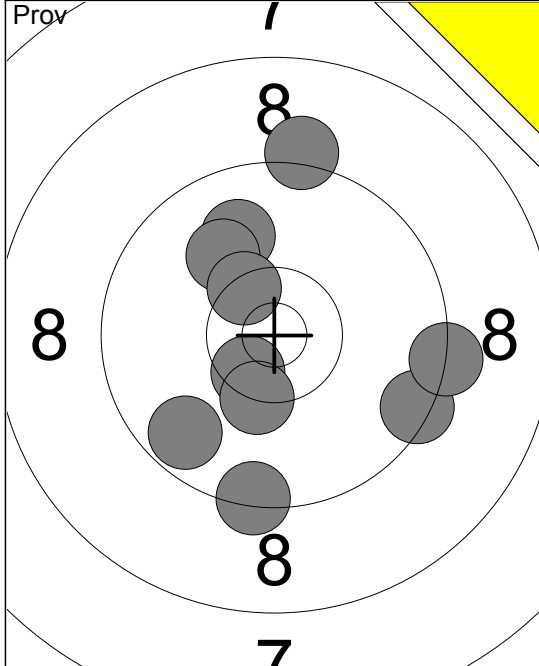

Prov

1:	9.9	↖
2:	9.2	↑
3:	10.5	↙
4:	10.3	↘
5:	10.0	↖
6:	9.4	→
7:	9.4	↓
8:	9.7	↙
9:	10.4	↗
10:	9.3	→
Serie	94.0	
Total	194.0	

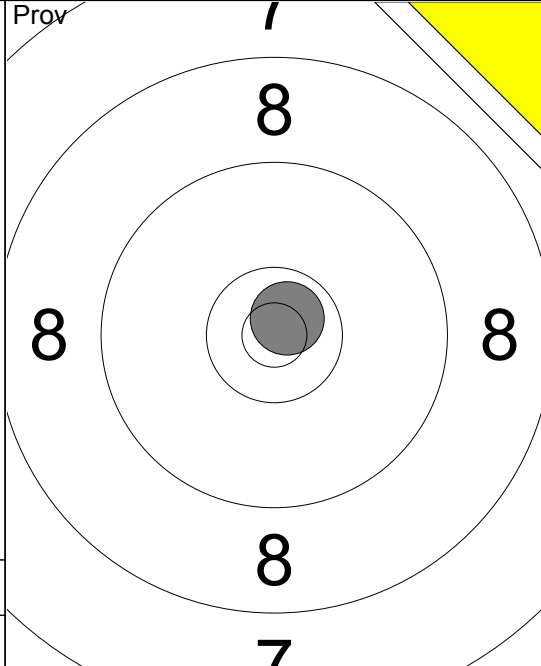

Prov

11:	10.7	↗
Serie	10.0	
Total	194.0	

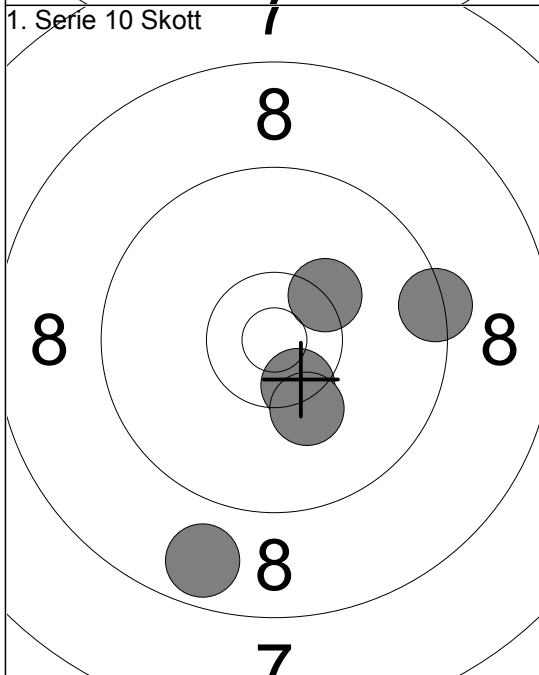

1:	10.3	↗
2:	10.5	↘
3:	8.7	↓
4:	9.4	→
5:	10.2	↘
Serie	47.0	
Total	241.0	

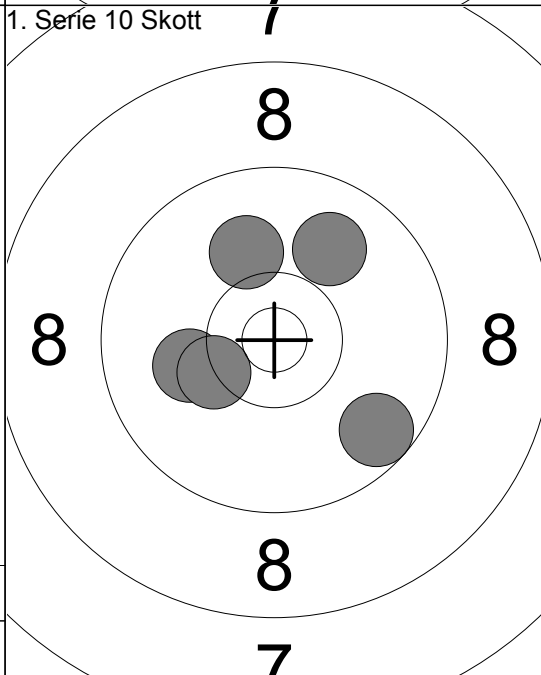

6:	10.1	↑
7:	10.1	←
8:	10.3	↙
9:	9.9	↗
10:	9.7	↘
Serie	48.0	
Total	289.0	

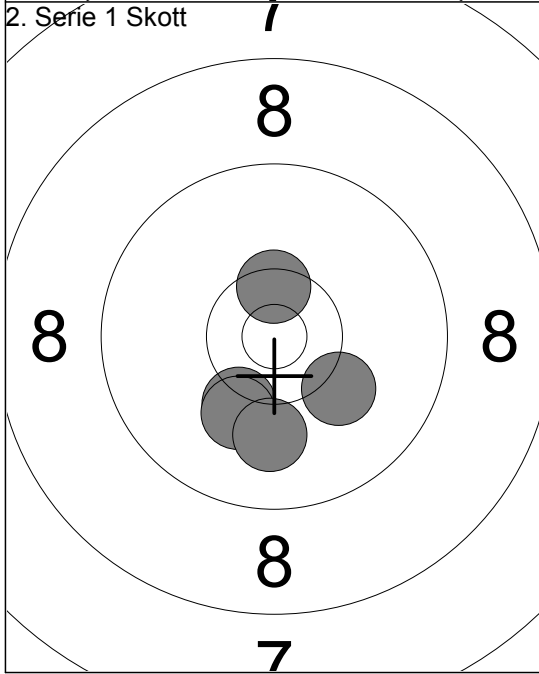

1:	10.5	↗
2:	10.2	↘
3:	10.1	↘
4:	10.2	↘
5:	10.0	↓
Serie	50.0	
Total	339.0	

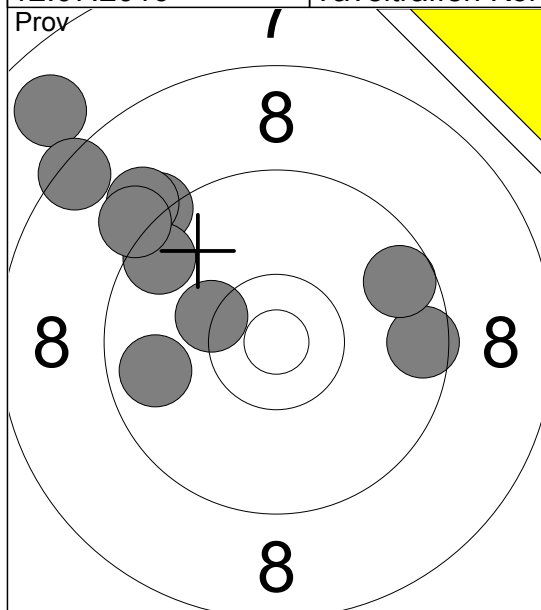

- 1: 9.8 ←
- 2: 9.2 ↗
- 3: 9.5 →
- 4: 9.6 ↗
- 5: 7.9 ↗
- 6: 8.4 ↗
- 7: 9.1 ↗
- 8: 10.3 ↖
- 9: 9.6 ↗
- 10: 9.2 ↖

Serie 88.0
Total 193.0

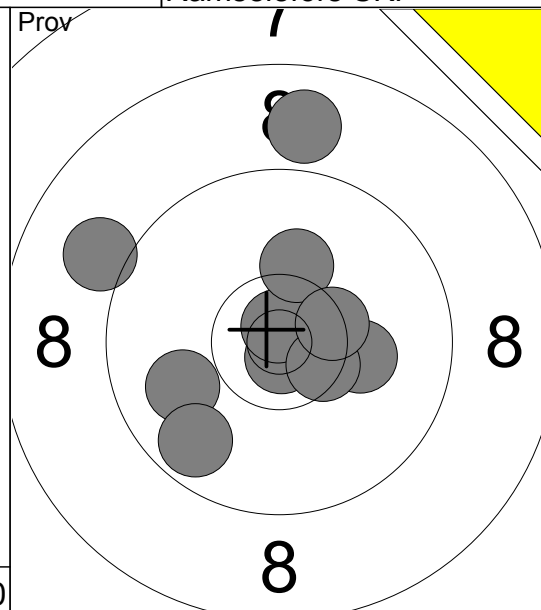

- 11: 9.0 ↖
- 12: 9.9 ↖
- 13: 9.7 ↘
- 14: 8.9 ↑
- 15: 10.8x↓
- 16: 10.2 →
- 17: 10.8x↑
- 18: 10.5x↘
- 19: 10.2 ↑
- 20: 10.4x→

Serie 95.0
Total 193.0

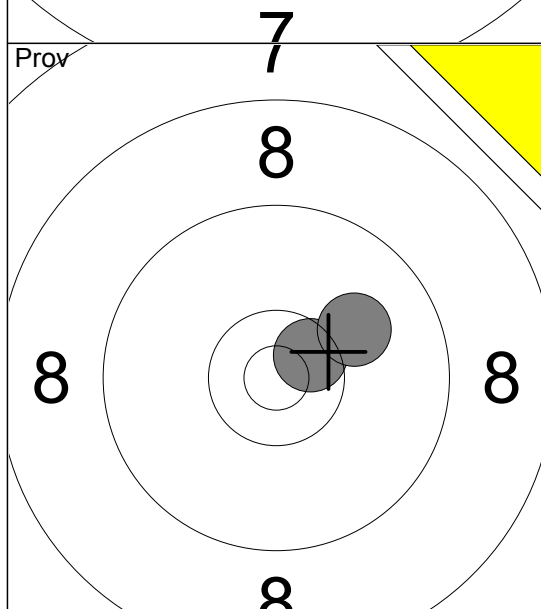

- 21: 10.6x↗
- 22: 10.1 ↗

Serie 20.0
Total 193.0

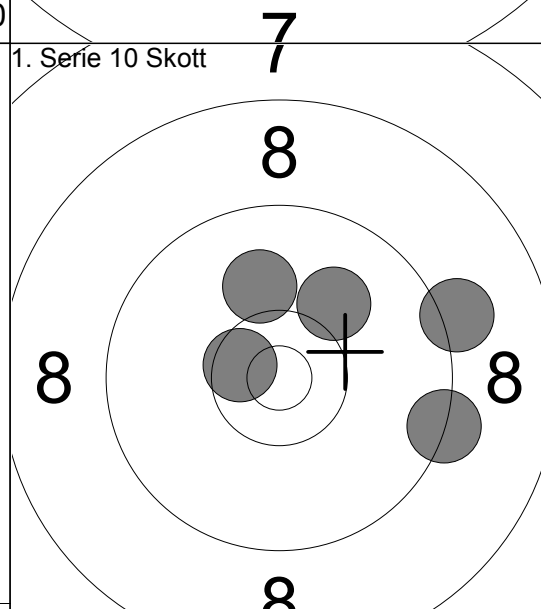

1. Serie 10 Skott
- 1: 10.1 ↑
 - 2: 9.2 →
 - 3: 10.6x↖
 - 4: 10.1 ↗
 - 5: 9.3 →

Serie 48.0
Total 241.0

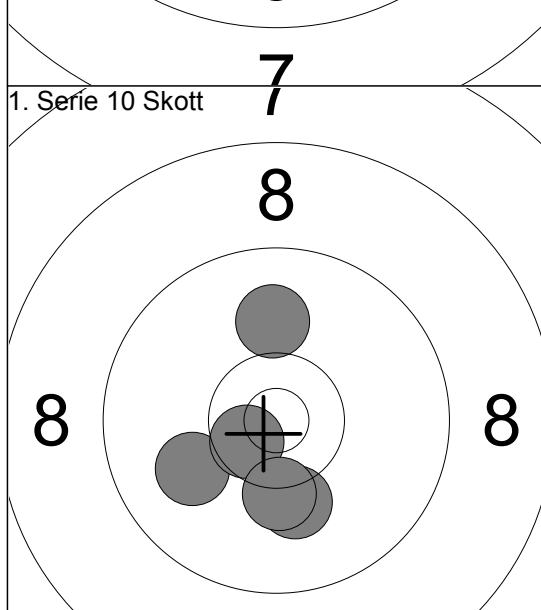

1. Serie 10 Skott
- 6: 10.2 ↓
 - 7: 10.0 ↑
 - 8: 10.0 ↖
 - 9: 10.6x↖
 - 10: 10.2 ↓

Serie 50.0
Total 291.0

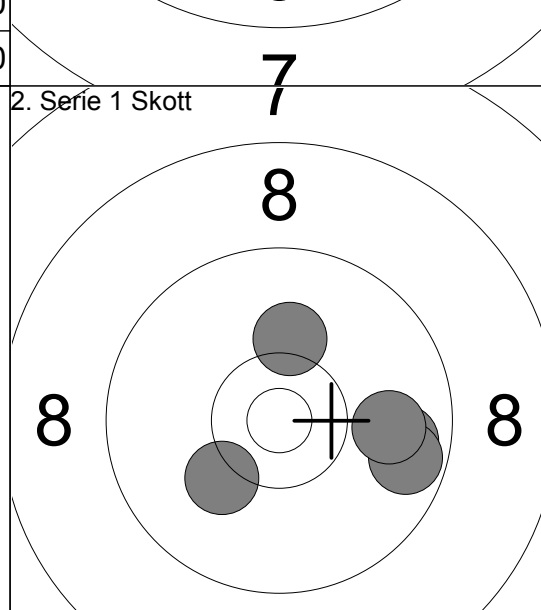

2. Serie 1 Skott
- 1: 10.2 ↑
 - 2: 9.8 →
 - 3: 9.7 →
 - 4: 9.9 →
 - 5: 10.2 ↖

Serie 47.0
Total 338.0

12.07.2016	Tavelträffen Korthåll 2016	Ramselefors SKF	
Prov 	1: 10.4x↓ 2: 9.7 ↓ 3: 10.1 ↓ 4: 10.0 ↓ 5: 10.2 ↓ 6: 10.5x↓ 7: 10.0 ← 8: 9.0 ↓ 9: 8.8 ↓ 10: 10.5x↑ Serie 96.0 Total 192.0	Prov 	11: 9.6 ↑ 12: 9.9 ↗ 13: 10.7x↓ 14: 10.3x↑ 15: 9.3 → 16: 10.6x→ 17: 9.8 → 18: 10.1 ↖ 19: 10.4x← Serie 86.0 Total 192.0
1. Serie 10 Skott 	1: 10.1 ↖ 2: 10.4x→ 3: 10.3x→ 4: 9.9 ↓ 5: 10.5x↓ Serie 49.0 Total 241.0	1. Serie 10 Skott 	6: 10.0 ↗ 7: 9.8 → 8: 9.0 ↗ 9: 9.5 ← 10: 9.8 → Serie 46.0 Total 287.0
2. Serie 1 Skott 	1: 10.4x↗ 2: 10.5x↖ 3: 10.6x↗ 4: 10.2 ← 5: 10.0 ← Serie 50.0 Total 337.0		

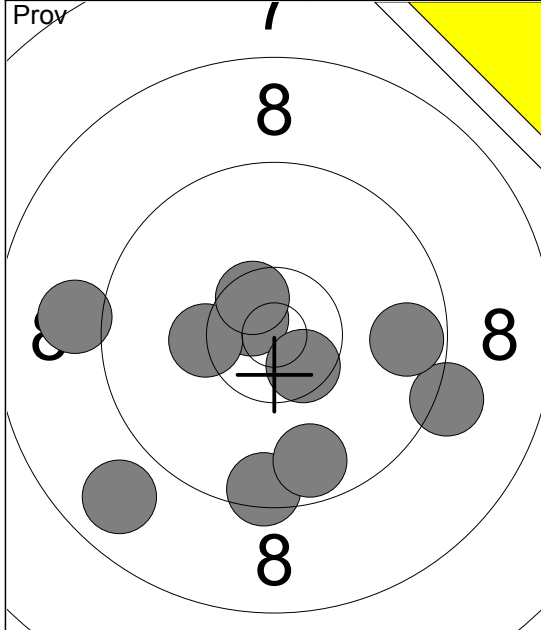

1:	10.7x ↘
2:	9.5 ↓
3:	9.7 ↓
4:	8.8 ↙
5:	9.2 →
6:	10.6x ↘
7:	10.3x ↙
8:	9.0 ←
9:	9.7 →
10:	10.5x ↘
Serie 93.0	
Total 192.0	

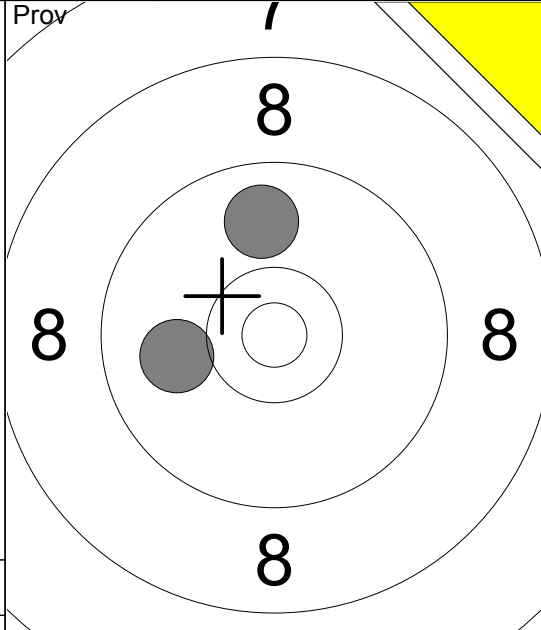

11:	10.0 ←
12:	9.9 ↑
Serie 19.0	
Total 192.0	

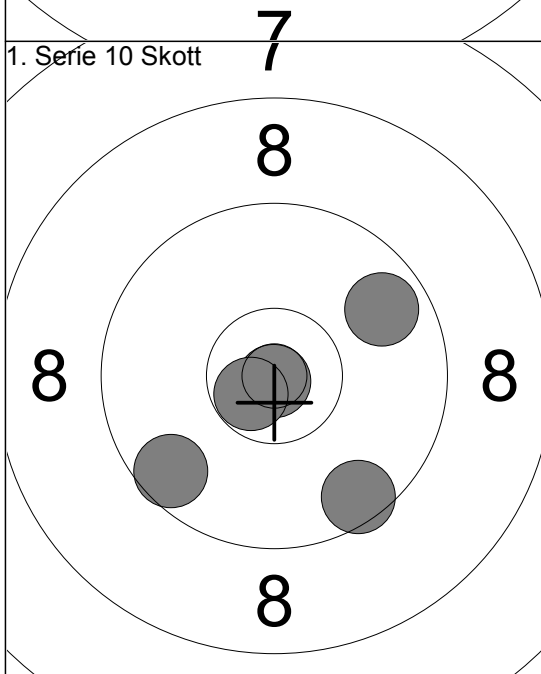

1:	9.5 ↓
2:	9.7 ↗
3:	10.9x ↓
4:	9.6 ↙
5:	10.7x ↘
Serie 47.0	
Total 239.0	

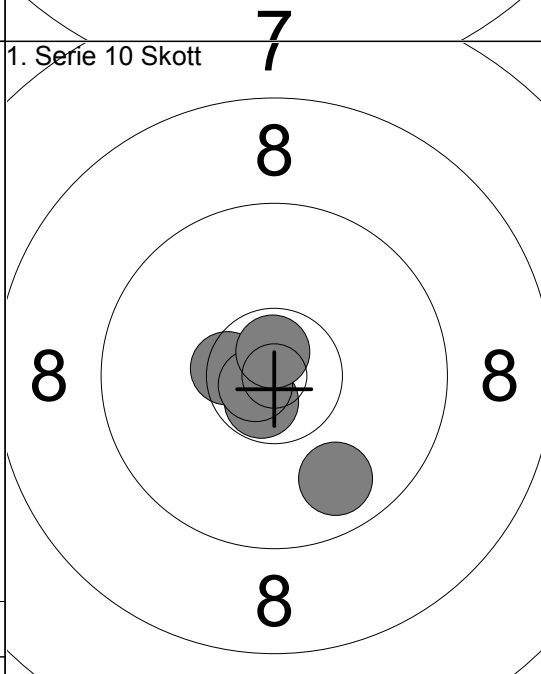

6:	10.5x ↘
7:	10.7x ↘
8:	9.8 ↓
9:	10.8x ↘
10:	10.7x ↑
Serie 49.0	
Total 288.0	

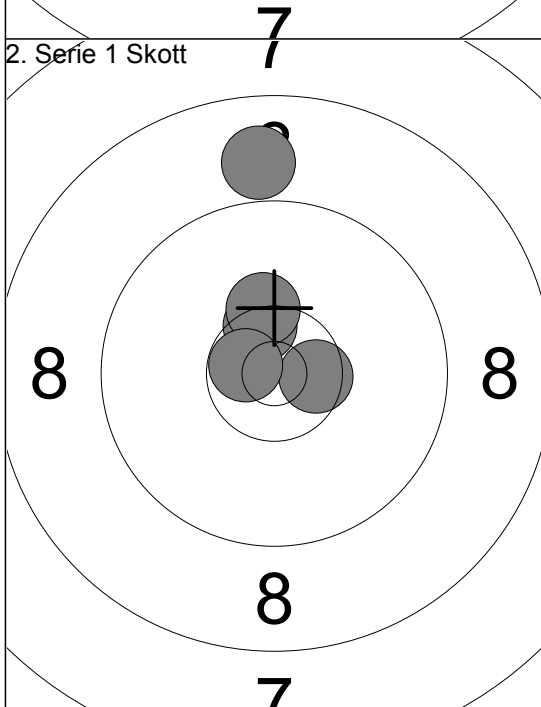

1:	10.5x ↗
2:	8.9 ↑
3:	10.6x →
4:	10.3x ↗
5:	10.7x ↘
Serie 48.0	
Total 336.0	

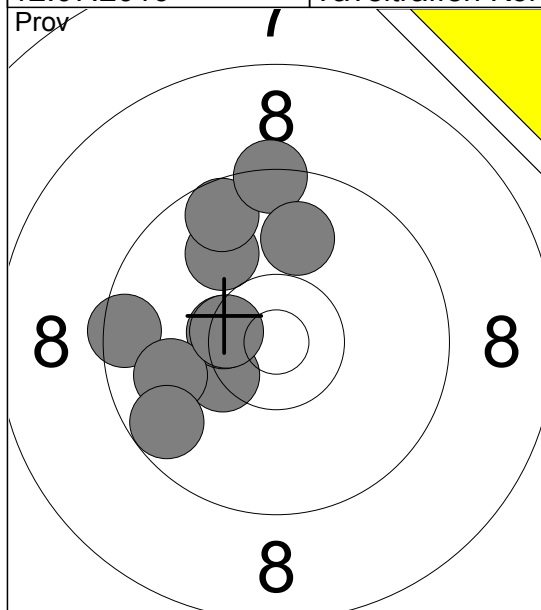

- 1: 10.0 ↖
- 2: 9.5 ←
- 3: 10.3 ✕
- 4: 10.4 ✕
- 5: 9.6 ↗
- 6: 9.9 ←
- 7: 10.5 ✕
- 8: 9.4 ↑
- 9: 9.7 ↙
- 10: 9.9 ↑

Serie 94.0

Total 189.0

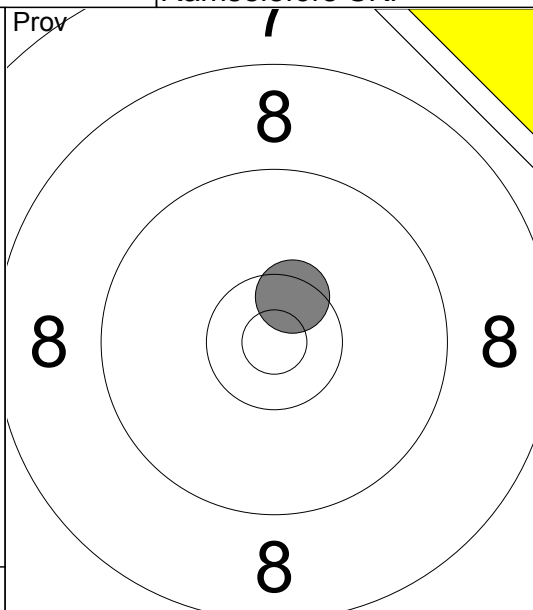

11: 10.5 ✕

Serie 10.0

Total 189.0

1. Serie 10 Skott

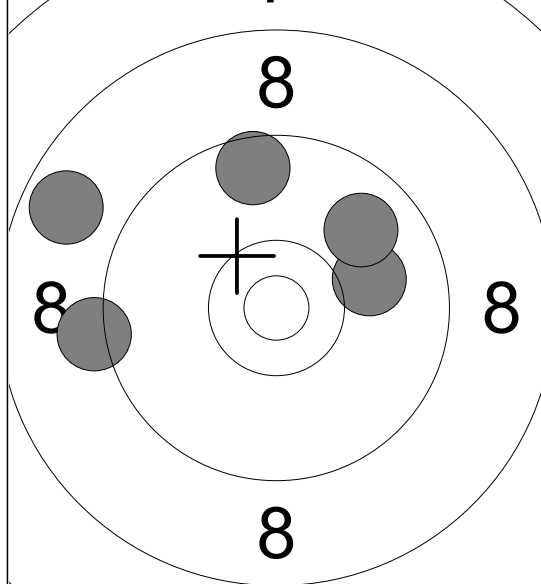

- 1: 10.0 →
- 2: 9.6 ↑
- 3: 9.9 ↗
- 4: 9.2 ←
- 5: 8.7 ↙

Serie 45.0

Total 234.0

1. Serie 10 Skott

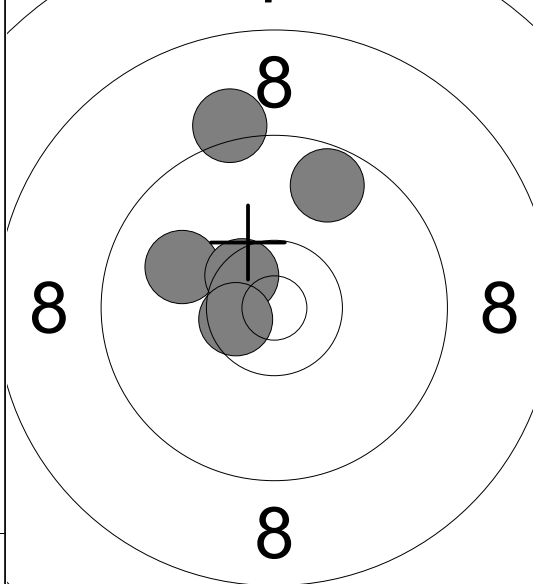

- 6: 9.7 ↗
- 7: 9.2 ↑
- 8: 10.0 ✕
- 9: 10.5 ✕
- 10: 10.6 ✕

Serie 48.0

Total 282.0

2. Serie 1 Skott

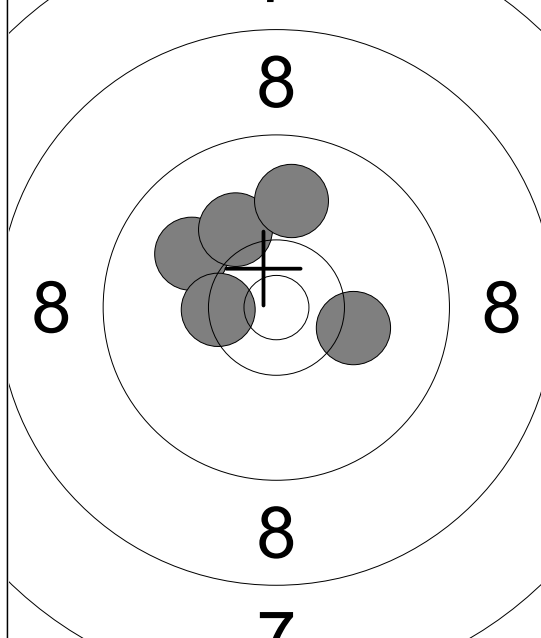

- 1: 10.2 →
- 2: 10.0 ↖
- 3: 10.4 ✕
- 4: 10.1 ↗
- 5: 9.9 ↑

Serie 49.0

Total 331.0

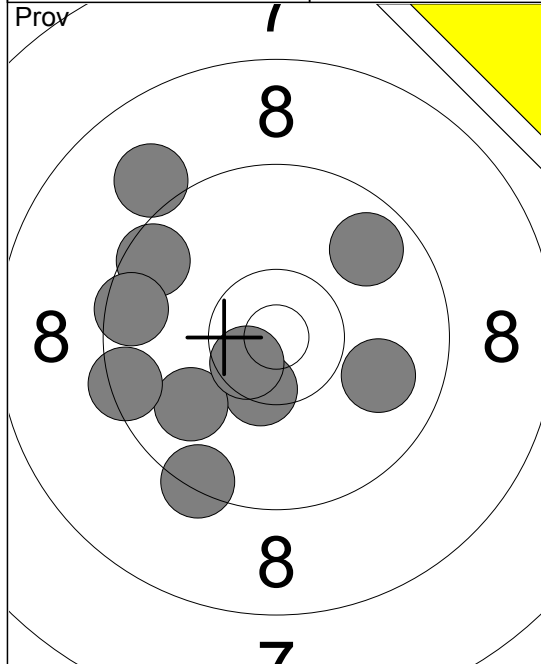

1:	9.0	↖
2:	9.6	↖
3:	9.7	↗
4:	9.4	↘
5:	9.9	→
6:	10.4x	↘
7:	9.9	↖
8:	9.5	↖
9:	9.4	↖
10:	10.6x	↘
Serie		92.0
Total		186.0

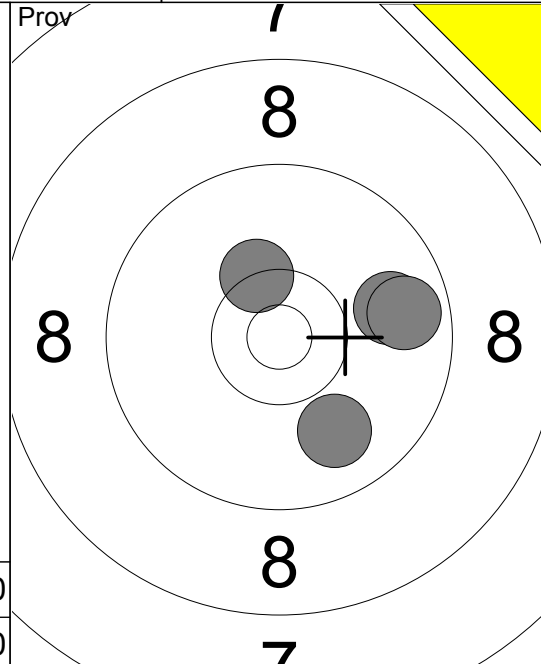

11:	9.9	→
13:	9.7	→
14:	9.9	↘
15:	10.3x	↗
Serie		37.0
Total		186.0

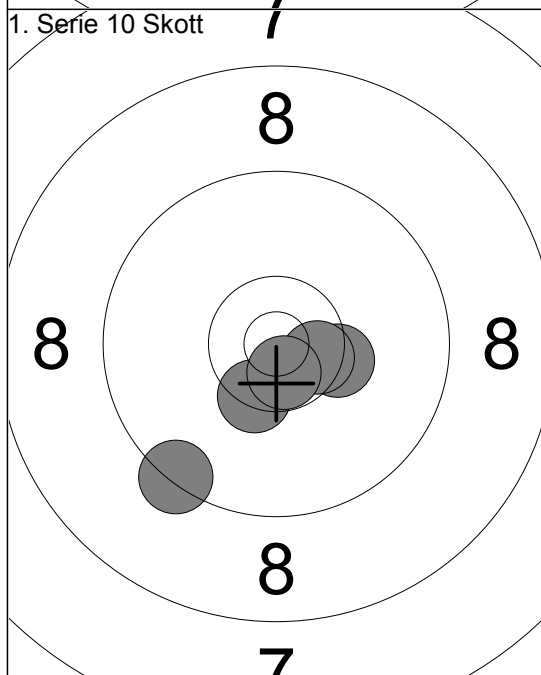

1:	10.4x	↘
2:	10.3x	→
3:	10.5x	→
4:	9.4	↘
5:	10.7x	↘
Serie		49.0
Total		235.0

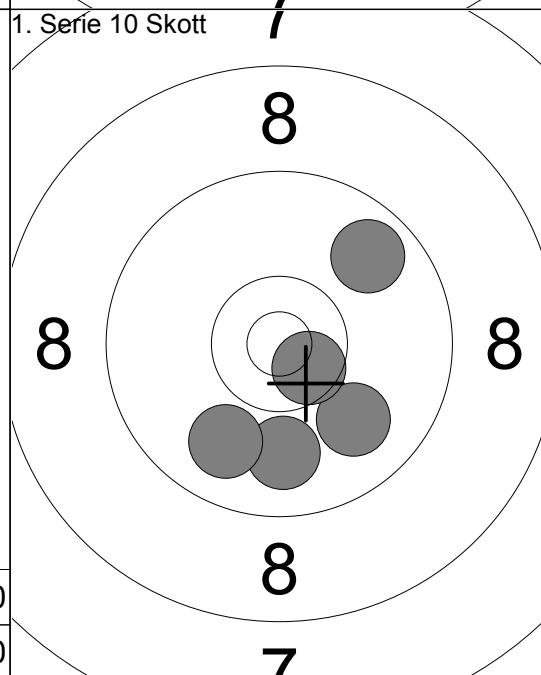

6:	9.9	↘
7:	9.9	↘
8:	10.6x	↘
9:	9.8	↗
10:	9.9	↘
Serie		46.0
Total		281.0

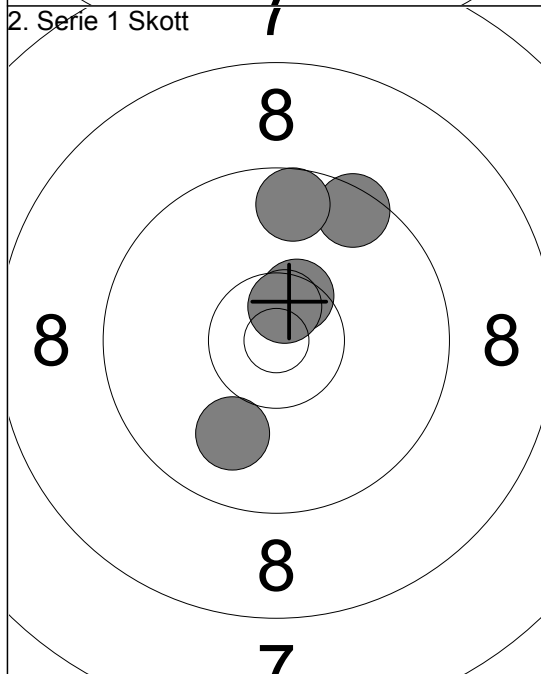

1:	10.5x	↗
2:	10.6x	↗
3:	10.0	↘
4:	9.5	↗
5:	9.6	↑
Serie		48.0
Total		329.0

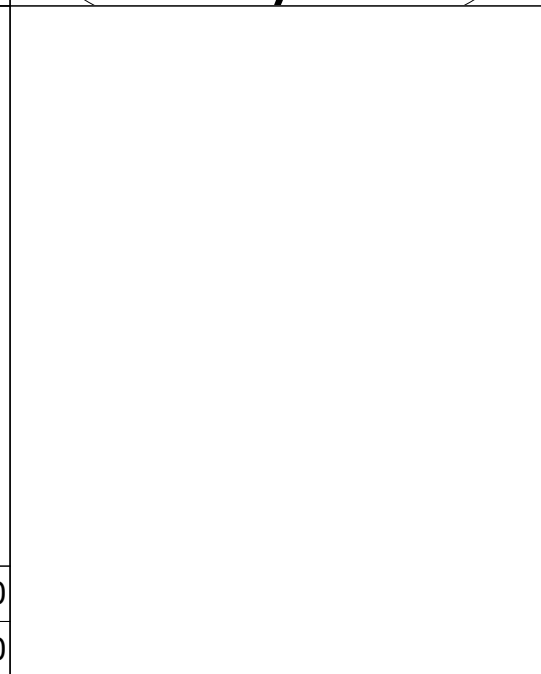

Serie		
Total		

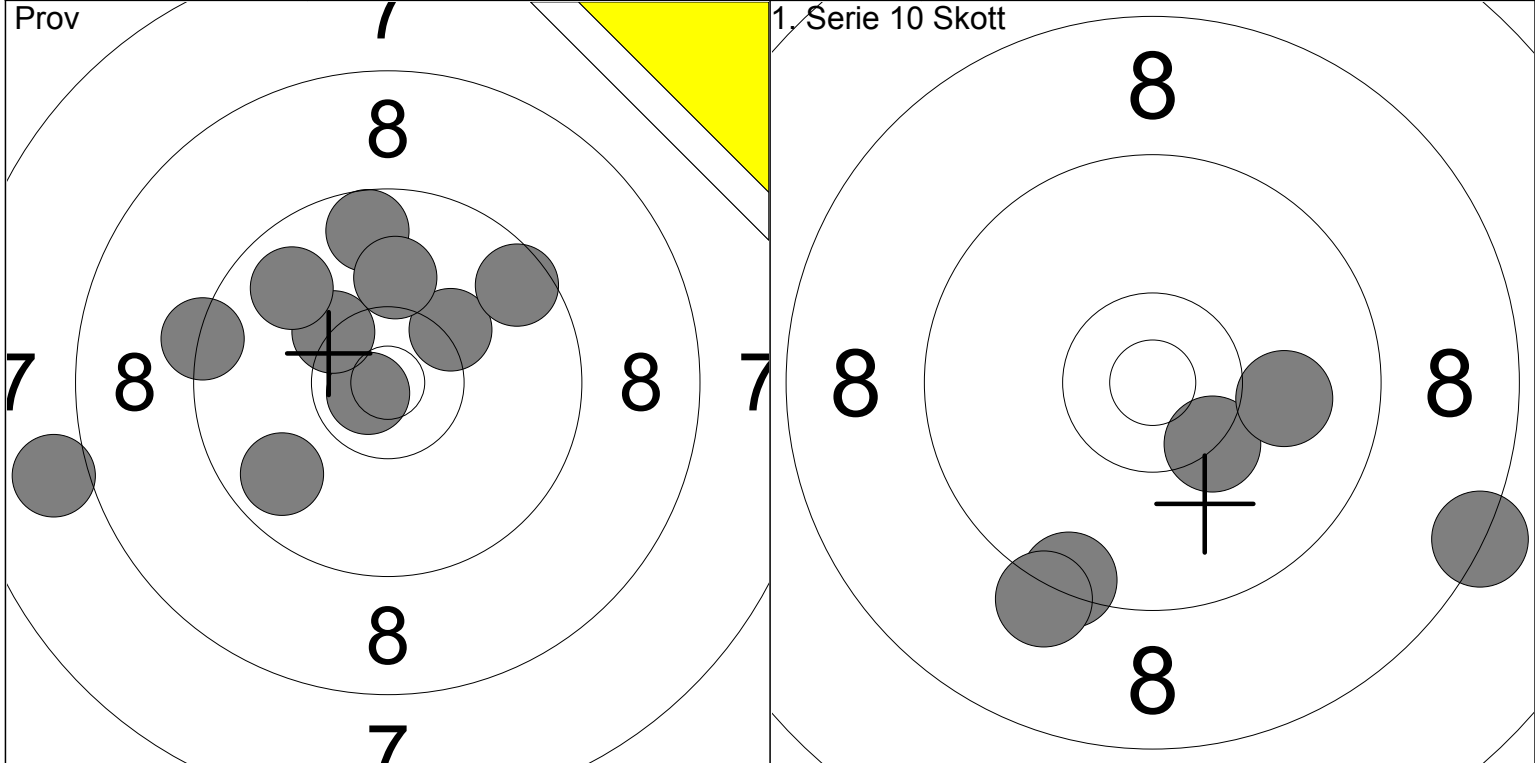

1: 9.3 ←	6: 9.8 ↖	Serie	93	1: 10.3x ↘	Serie	46
2: 9.7 ↑	7: 10.1 ↑		Total	185		2: 10.0 →
3: 10.3 ↗	8: 9.6 ↗	3: 9.4 ↘		4: 8.3 →		
4: 10.8x ←	9: 9.8 ↘	5: 9.2 ↘				
5: 10.3x ↖	10: 8.0 ←					

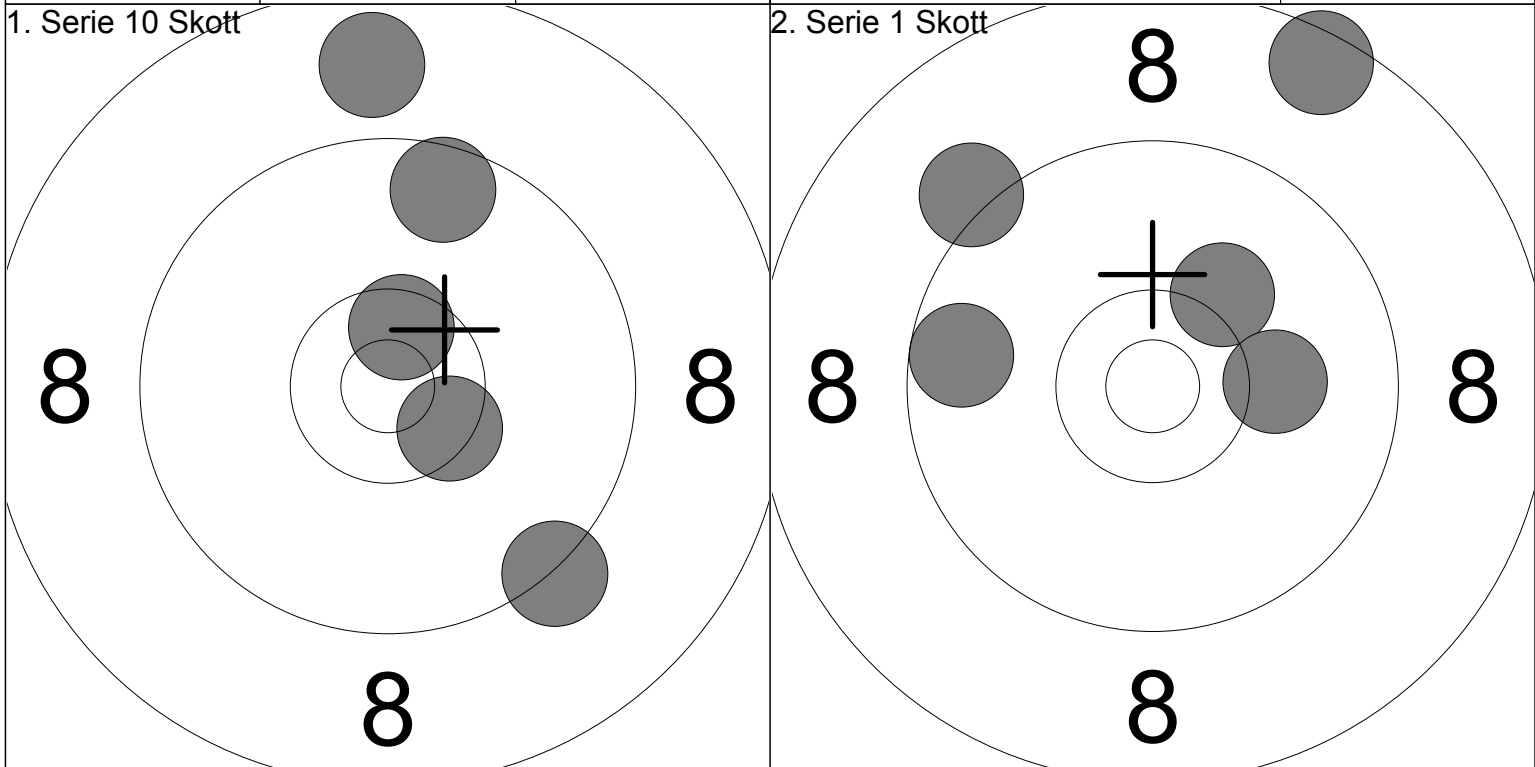

6: 9.3 ↘	Serie	46	1: 9.2 ↖	Serie	46
7: 10.5x ↘		Total	277		2: 8.5 ↑
8: 8.8 ↑	3: 10.2 ↗		4: 9.7 ←		
9: 10.5x ↑	5: 10.1 →				
10: 9.6 ↑					

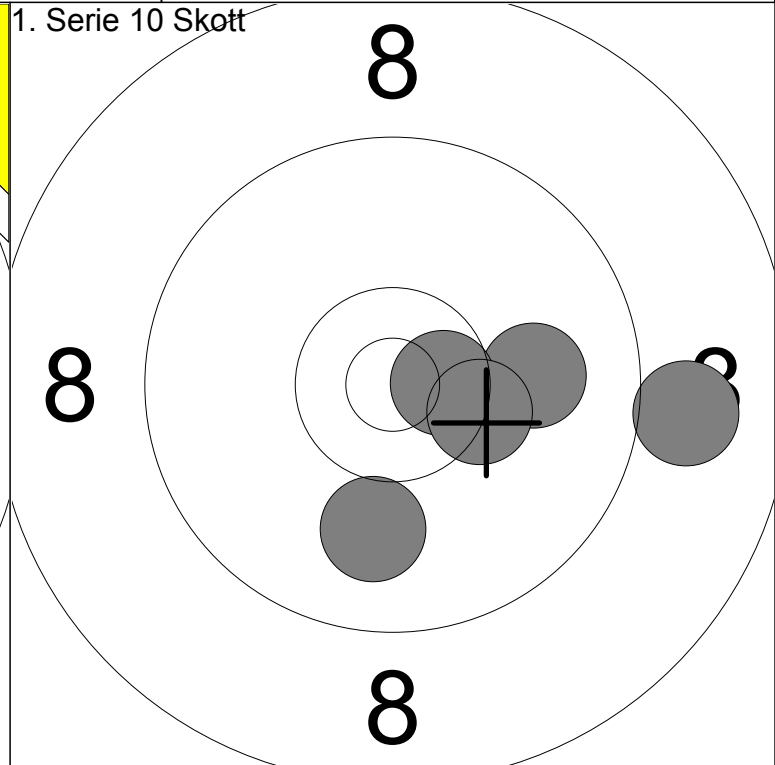
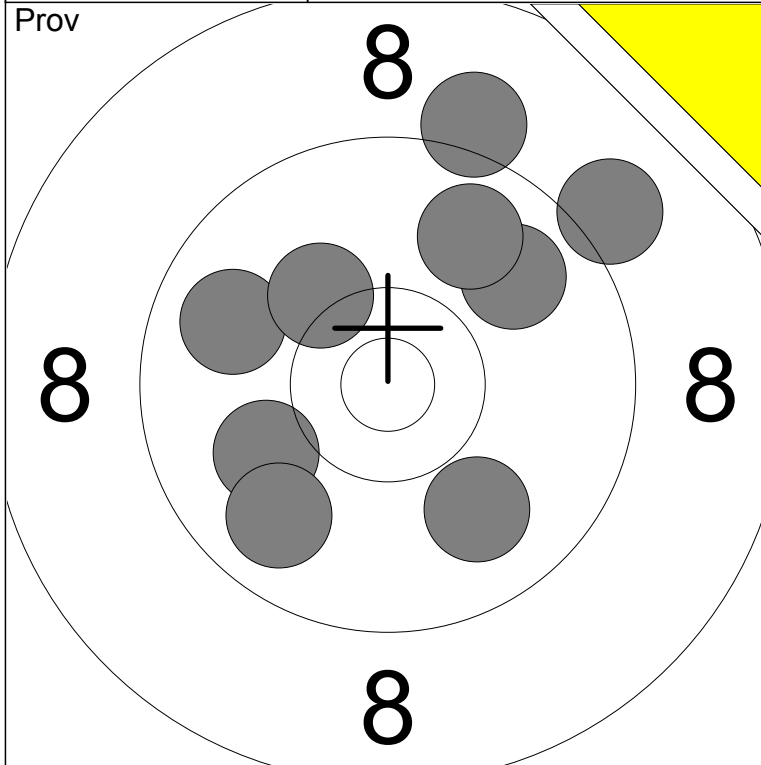

1: 9.1 ↗	7: 9.8 ↘	Serie	83
2: 9.8 ↖	8: 9.8 ↗		
3: 10.0 ↙	9: 10.2 ↘	Total	184
5: 9.8 ↗	10: 9.1 ↗		
6: 9.9 ↘			

1: 9.0 →	Serie	49
2: 10.0 →		
3: 10.6x →	Total	233
4: 10.0 ↓		
5: 10.3x →		

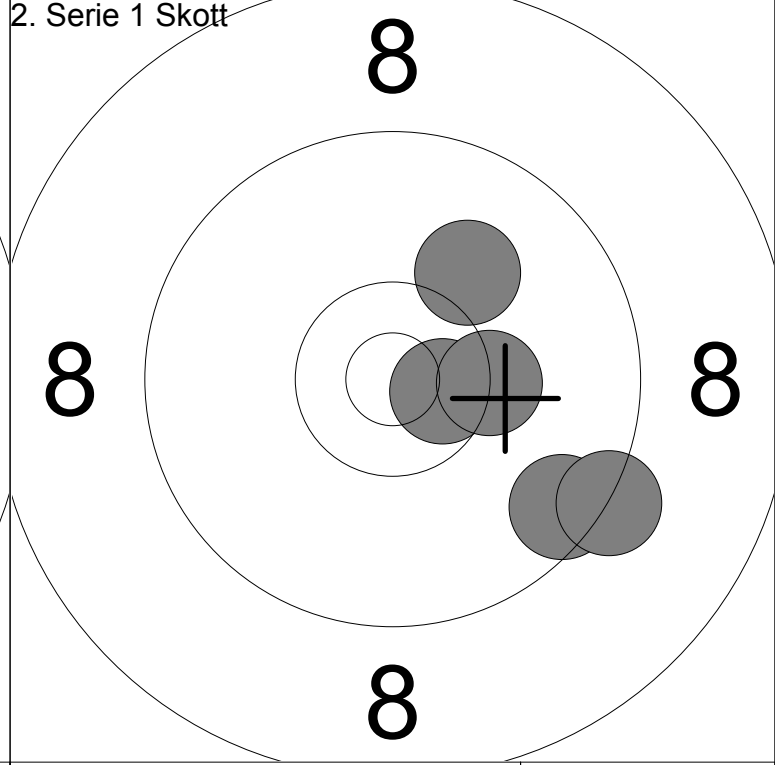
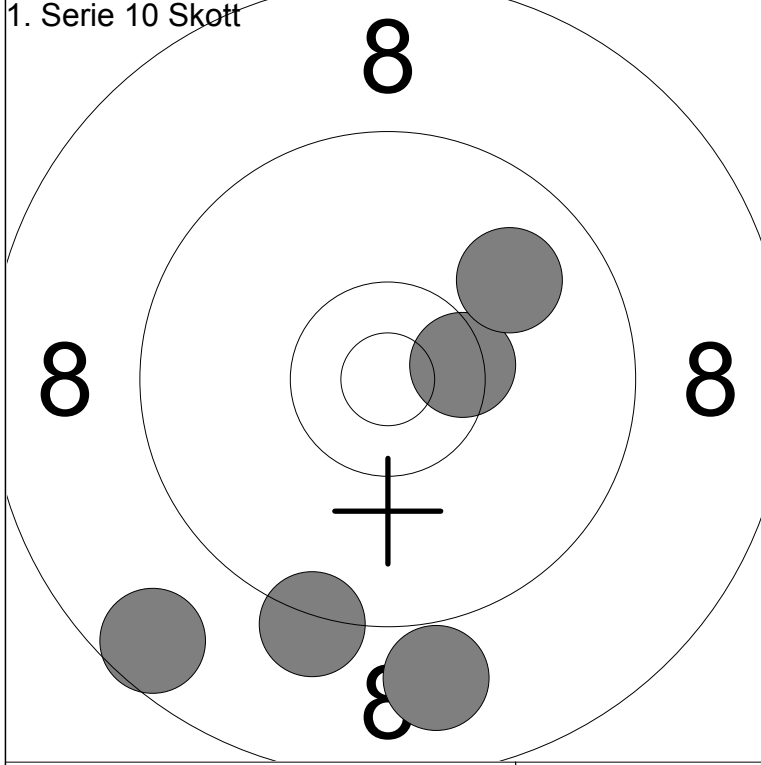

6: 8.9 ↓	Serie	44
7: 10.4x →		
8: 8.6 ↘	Total	277
9: 9.2 ↓		
10: 9.9 ↗		

1: 10.6x →	Serie	48
2: 9.5 ↘		
3: 10.3x →	Total	325
4: 9.3 ↘		
5: 10.1 ↗		

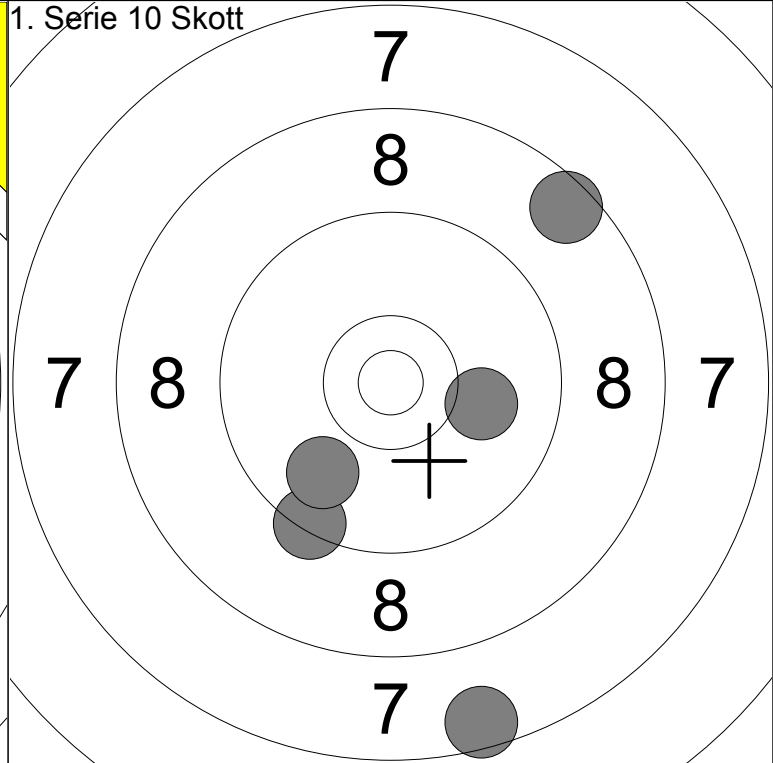
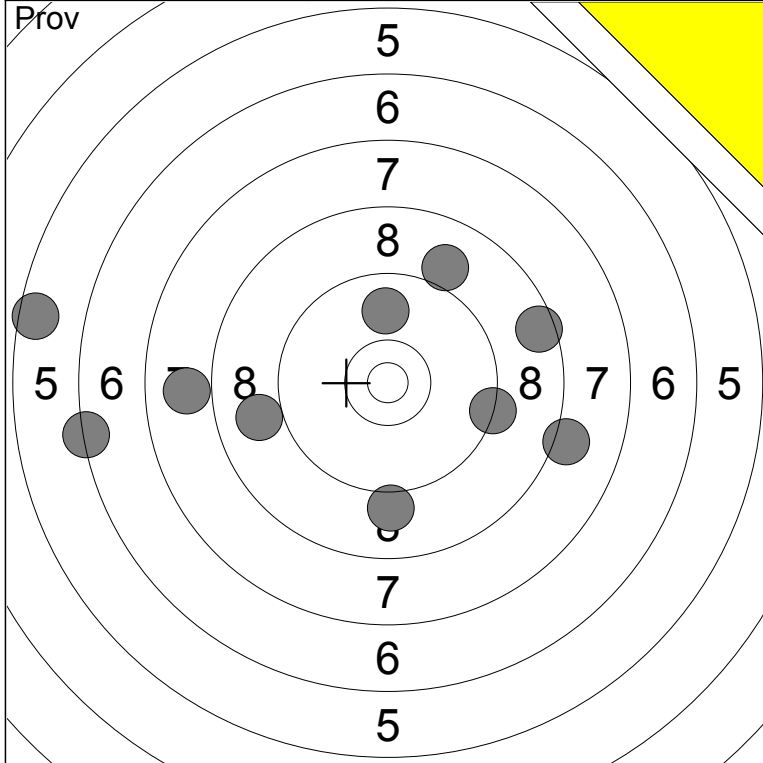

1: 6.3 ←	6: 9.3 →	Serie	78
2: 5.5 ←	7: 9.9 ↑		
3: 8.5 →	8: 9.1 ↓	Total	170
4: 9.0 ↗	9: 8.9 ←		
5: 8.1 →	10: 7.9 ←		

1: 7.6 ↓	Serie	43
2: 9.4 ↘		
3: 8.6 ↗	Total	213
4: 9.9 ↘		
5: 10.1 →		

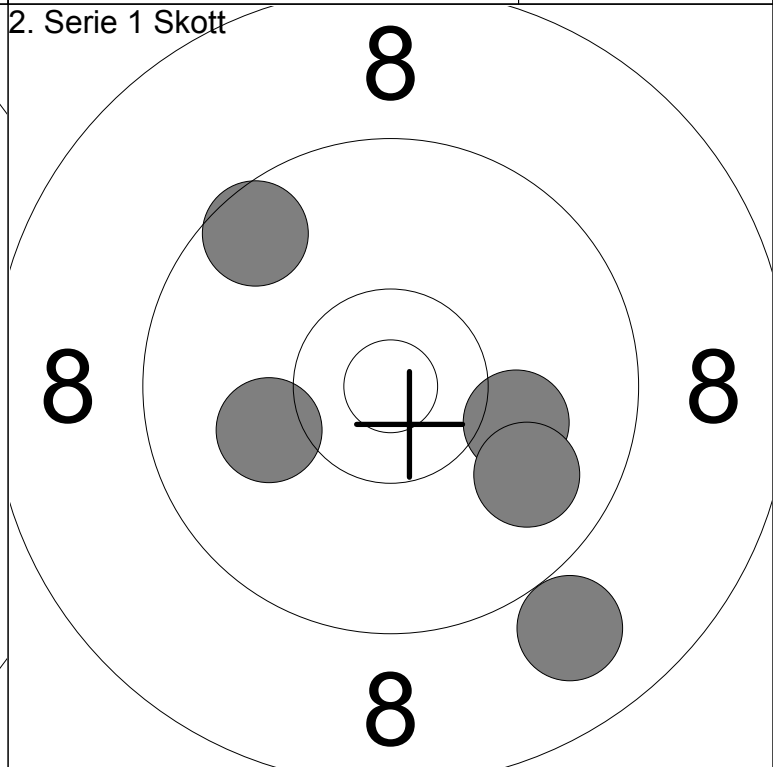
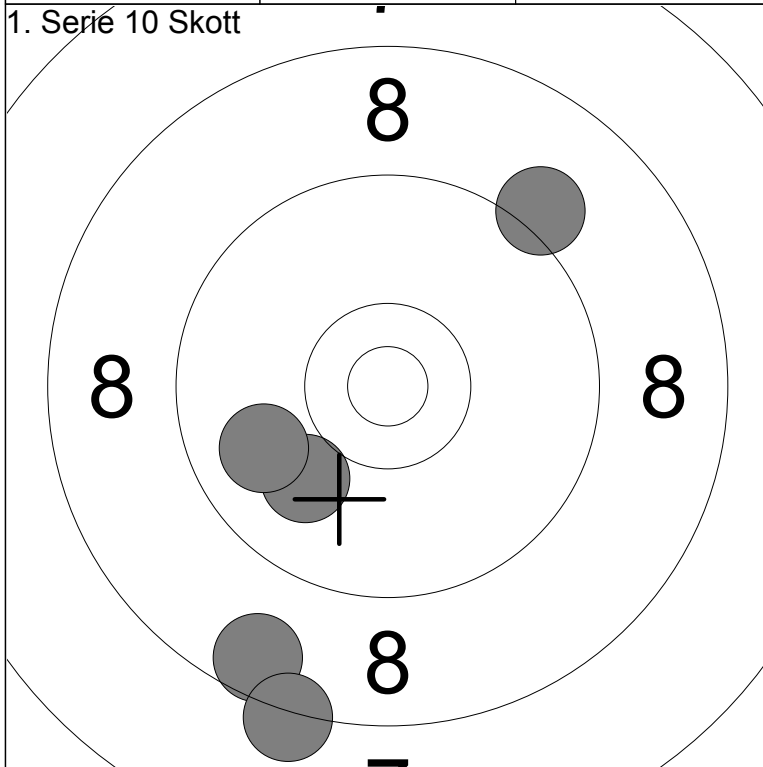

6: 9.1 ↗	Serie	44
7: 10.0 ↘		
8: 9.9 ←	Total	257
9: 8.6 ↓		
10: 8.3 ↓		

1: 9.6 ↗	Serie	46
2: 10.1 ←		
3: 10.1 →	Total	303
4: 9.9 ↘		
5: 8.9 ↓		

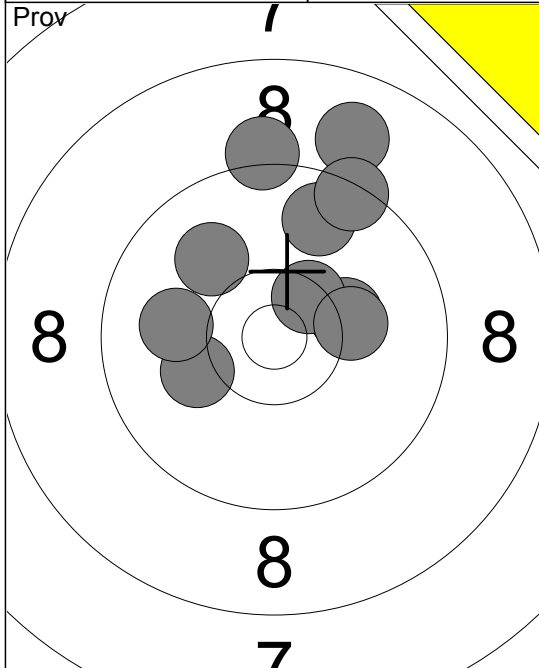

1:	8.9	↗
2:	10.2	→
3:	10.5	↗
4:	9.2	↑
5:	10.0	↖
6:	10.1	←
7:	9.7	↗
8:	10.2	→
9:	9.4	↗
10:	10.0	←
Serie	95.0	
Total	191.0	

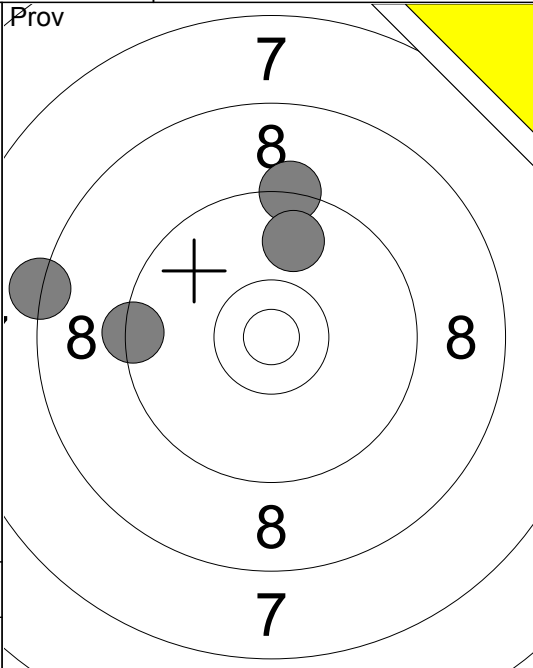

11:	9.3	↑
12:	9.8	↑
13:	9.4	←
14:	8.3	←
Serie	35.0	
Total	191.0	

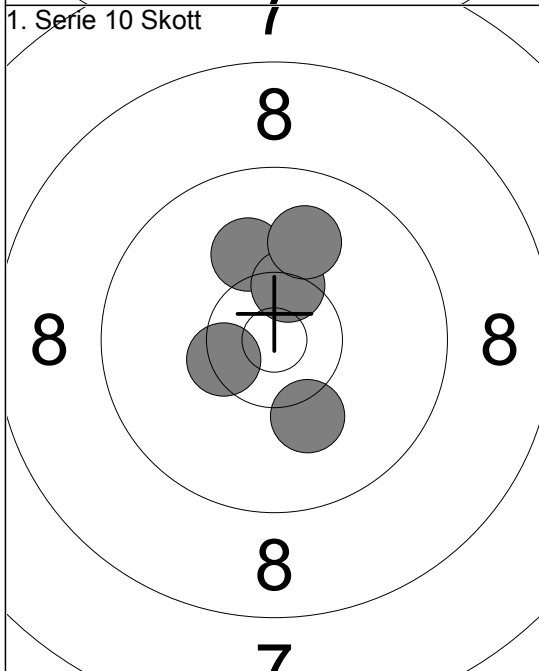

1:	10.1	↑
2:	10.4	↗
3:	10.0	↑
4:	10.4	↘
5:	10.2	↘
Serie	50.0	
Total	241.0	

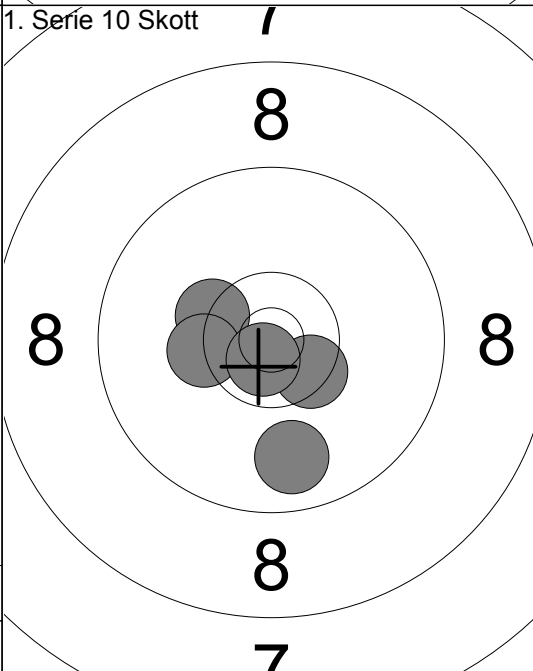

6:	10.3	↘
7:	10.3	↘
8:	9.8	↓
9:	10.5	↘
10:	10.7	↘
Serie	49.0	
Total	290.0	

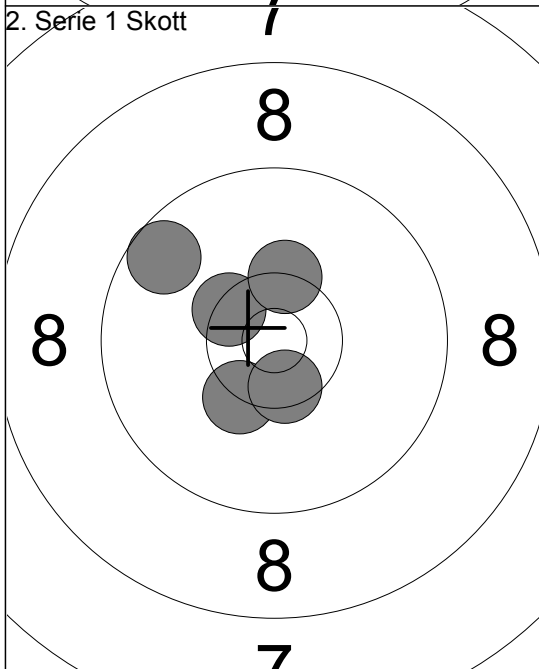

1:	10.4	↘
2:	10.3	↘
3:	10.3	↗
4:	10.5	↘
5:	9.6	↖
Serie	49.0	
Total	339.0	

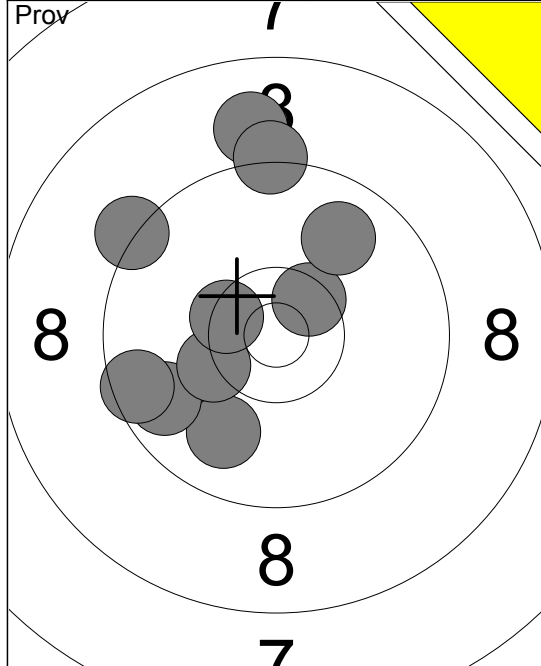

1:	9.9	↘
2:	10.5	↗
3:	9.7	↙
4:	10.3	↙
5:	9.9	↗
6:	10.4	↘
7:	9.0	↑
8:	9.3	↑
9:	9.5	↙
10:	9.3	↙
Serie		93.0
Total		190.0

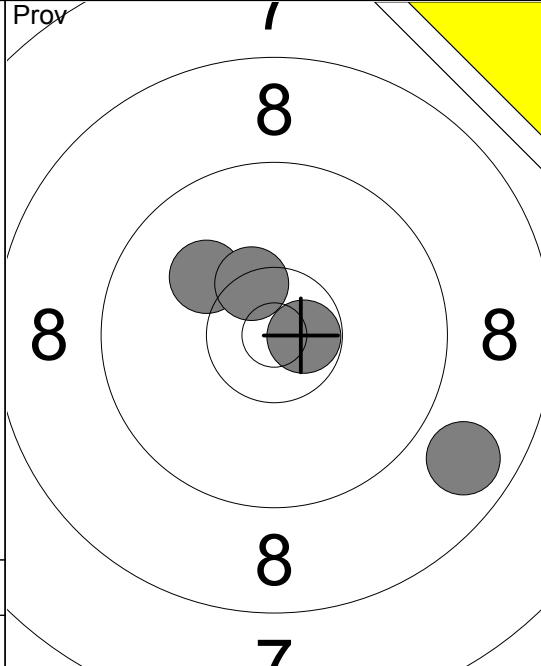

11:	10.1	↖
12:	10.7	→
13:	8.8	↘
14:	10.4	↗
Serie		38.0
Total		190.0

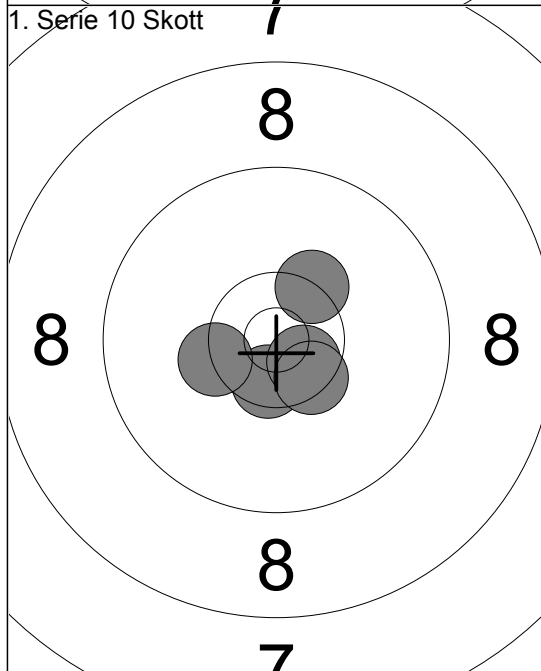

1:	10.5	↘
2:	10.3	↗
3:	10.6	↘
4:	10.3	↘
5:	10.5	↘
Serie		50.0
Total		240.0

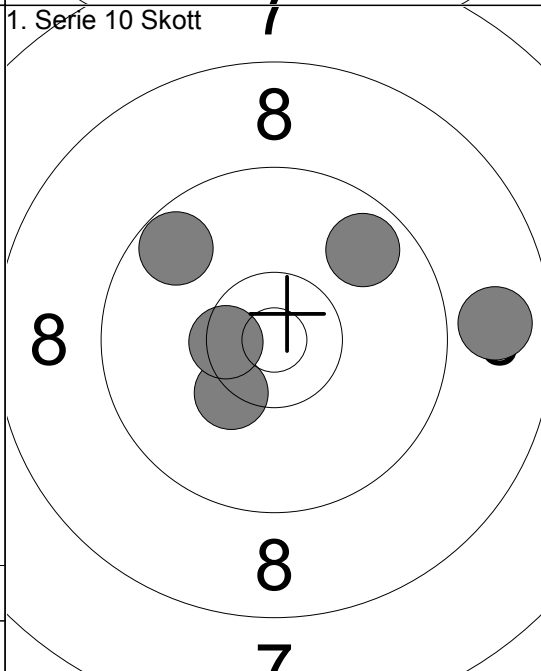

6:	9.7	↖
7:	9.7	↗
8:	10.3	↘
9:	8.8	→
10:	10.5	↘
Serie		46.0
Total		286.0

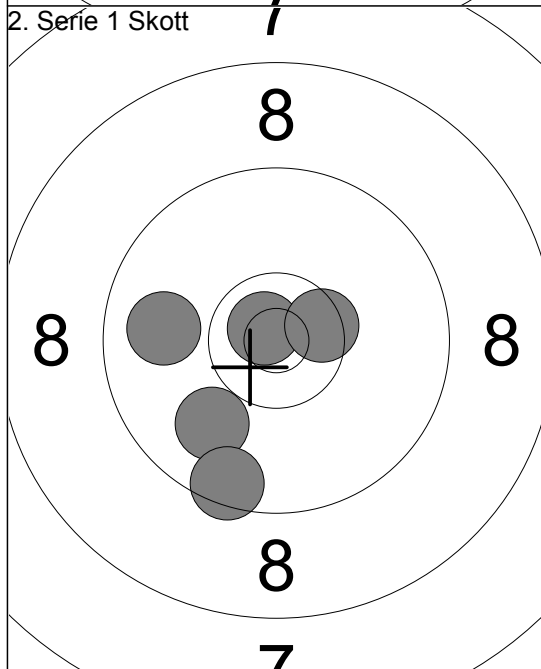

1:	9.9	↘
2:	10.8	↘
3:	9.5	↘
4:	10.5	→
5:	9.9	↙
Serie		47.0
Total		333.0

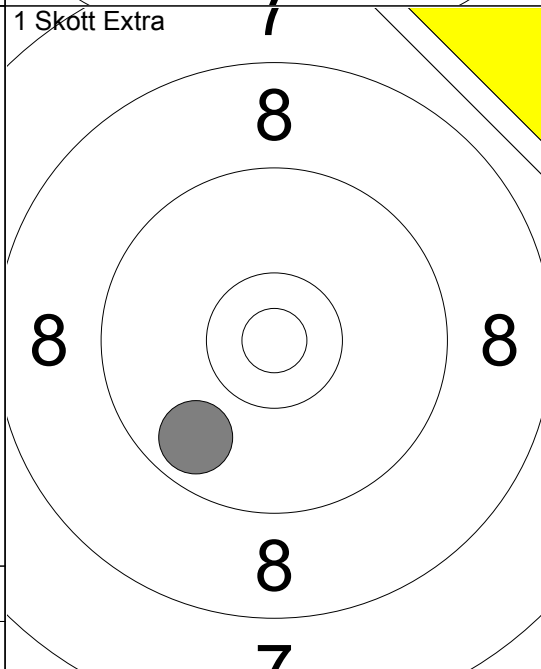

1:	9.8	↘
Serie		9.0
Total		333.0

Skjutlag 6 Tavlå 3 **Saga Ebbhågen**

50m Ramselefors 6, Ung Vb

12.07.2016 Taveltråffen Korthåll 2016 Ramselefors SKF

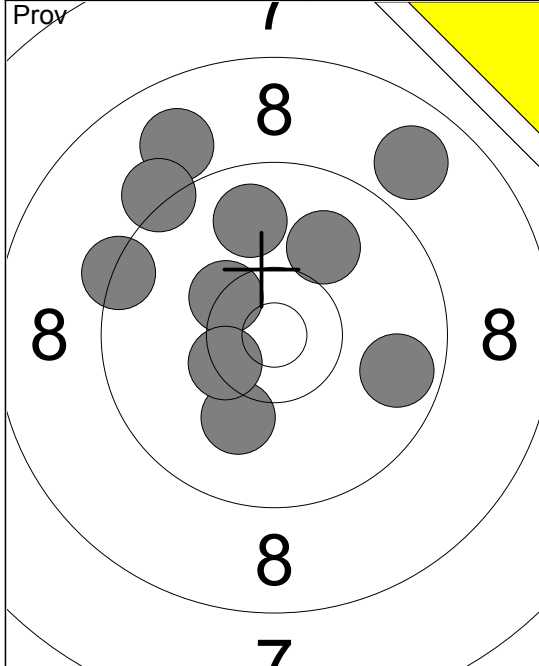

1:	8.9	↗
2:	8.9	↗
3:	9.7	→
4:	9.2	↗
5:	10.4	x
6:	10.0	↗
7:	9.4	↖
8:	9.8	↗
9:	10.1	↘
10:	10.4	x
Serie		92.0
Total		189.0

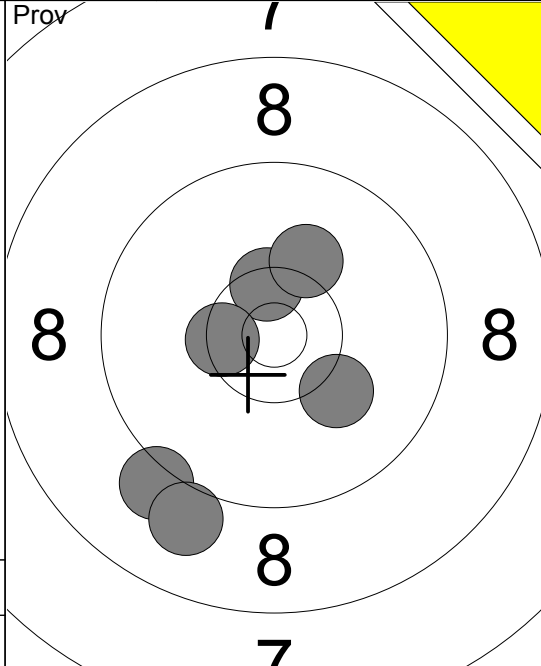

11:	9.1	↘
12:	10.5	x↗
13:	10.2	↘
14:	9.0	↘
15:	10.5	x
16:	10.2	↗
Serie		58.0
Total		189.0

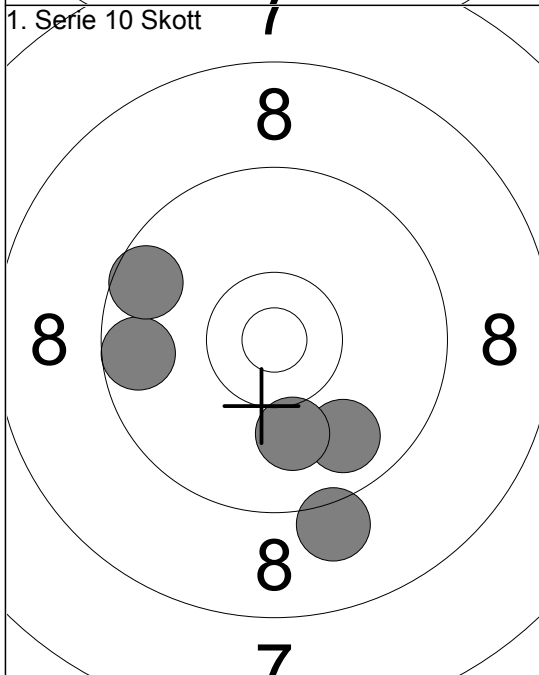

1:	9.1	↘
2:	9.6	↖
3:	9.6	↖
4:	9.8	↘
5:	10.0	↘
Serie		46.0
Total		235.0

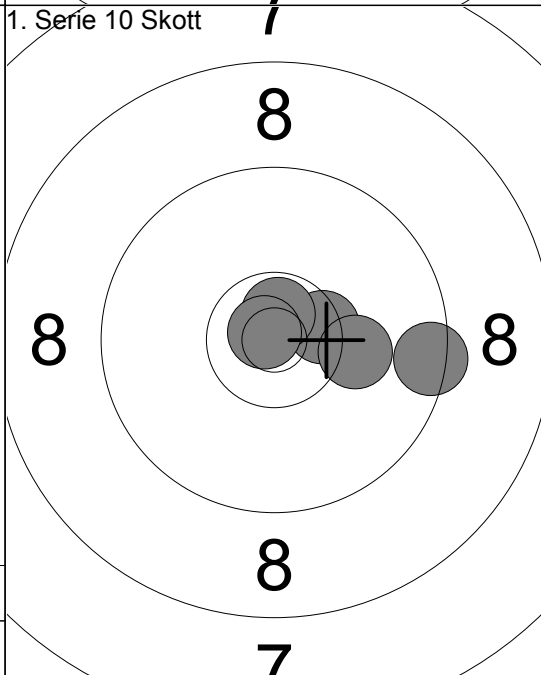

6:	9.4	→
7:	10.5	x→
8:	10.7	x↗
9:	10.8	x
10:	10.2	→
Serie		49.0
Total		284.0

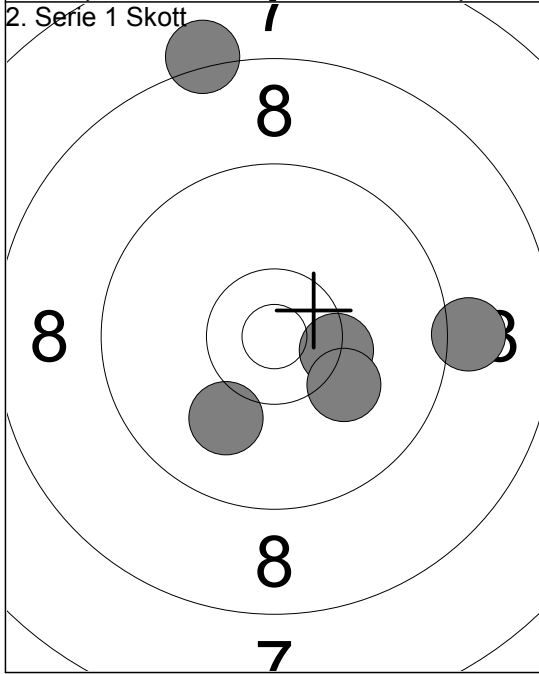

1:	10.3	x→
2:	10.0	↘
3:	10.1	↘
4:	9.1	→
5:	8.2	↗
Serie		47.0
Total		331.0

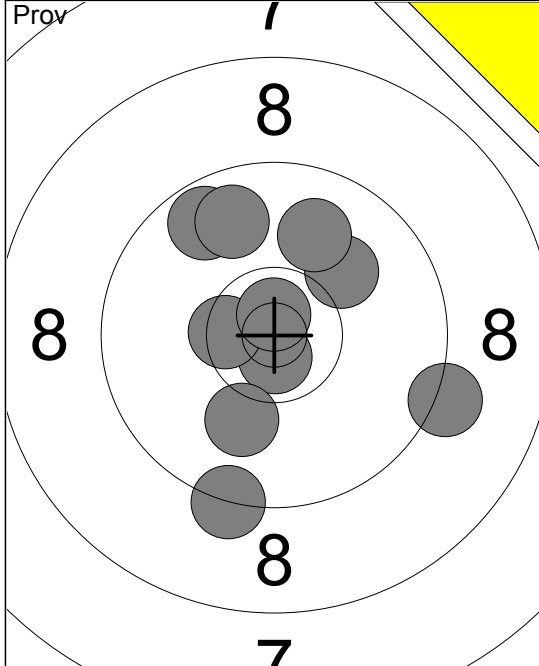

Prov

1:	9.7	↖
2:	10.7	x↓
3:	10.1	↓
4:	10.5	x←
5:	10.1	↗
6:	10.8	x↑
7:	9.8	↖
8:	9.9	↖
9:	9.2	→
10:	9.3	↓
Serie		95.0
Total		189.0

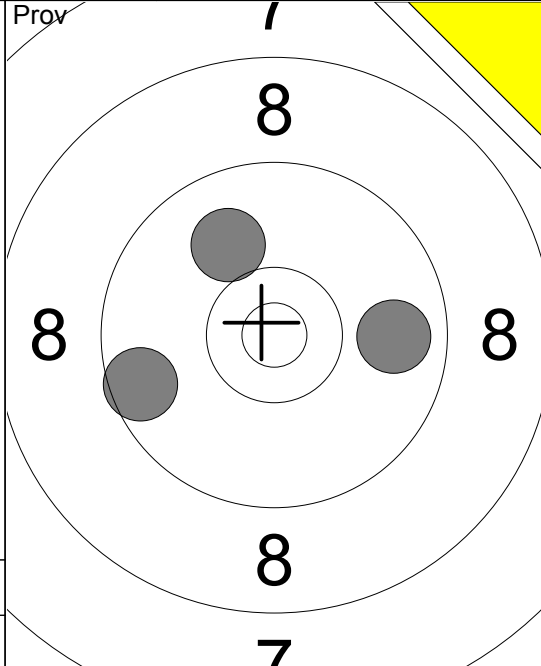

Prov

11:	9.6	←
12:	10.0	↖
13:	9.8	→
Serie		28.0
Total		189.0

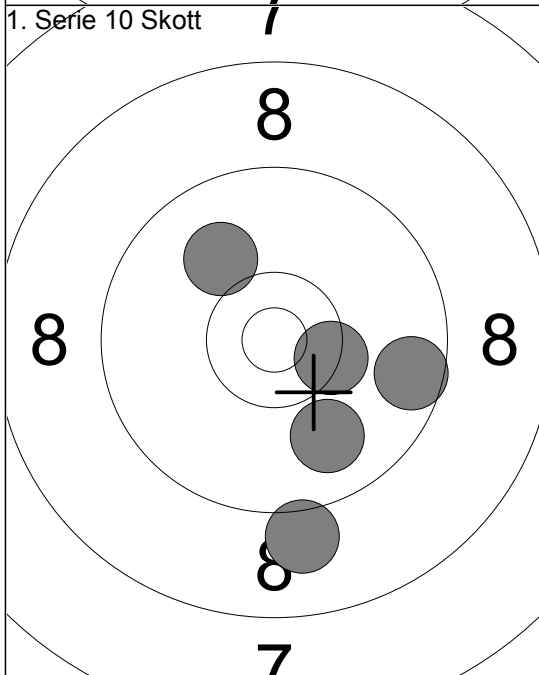

1. Serie 10 Skott

1:	10.4	x→
2:	9.6	→
3:	10.0	↖
4:	9.1	↓
5:	9.9	↘
Serie		47.0
Total		236.0

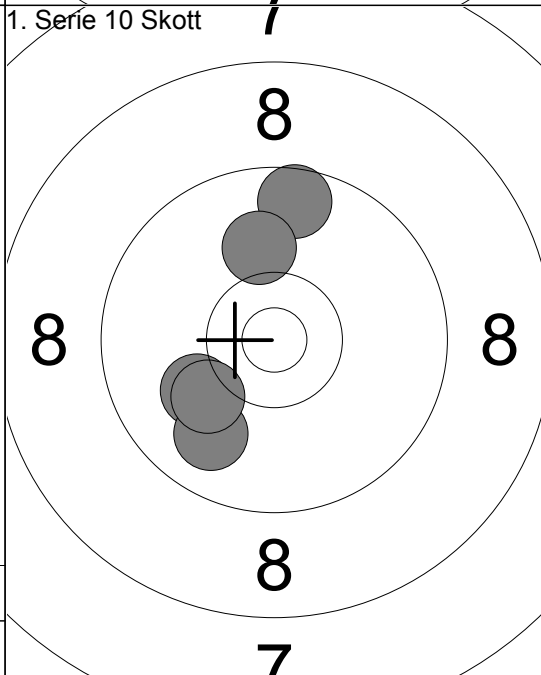

1. Serie 10 Skott

6:	10.1	↖
7:	9.6	↖
8:	9.9	↘
9:	10.1	↖
10:	10.1	↖
Serie		48.0
Total		284.0

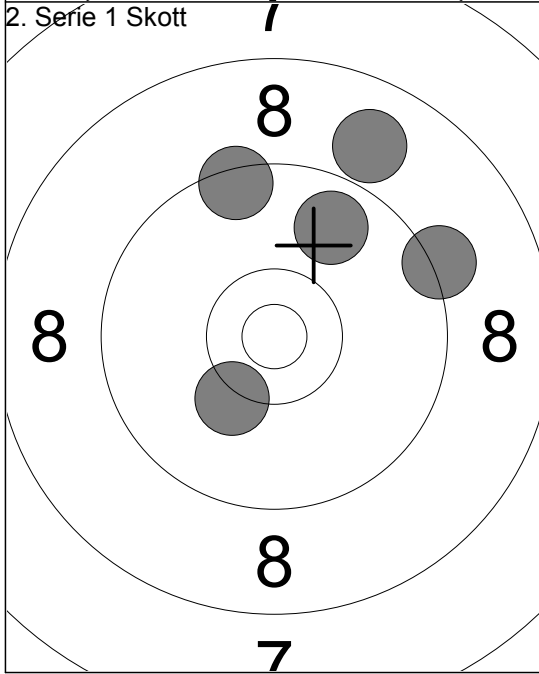

2. Serie 1 Skott

1:	9.4	↖
2:	9.2	→
3:	8.9	↖
4:	10.2	↘
5:	9.8	↖
Serie		45.0
Total		329.0

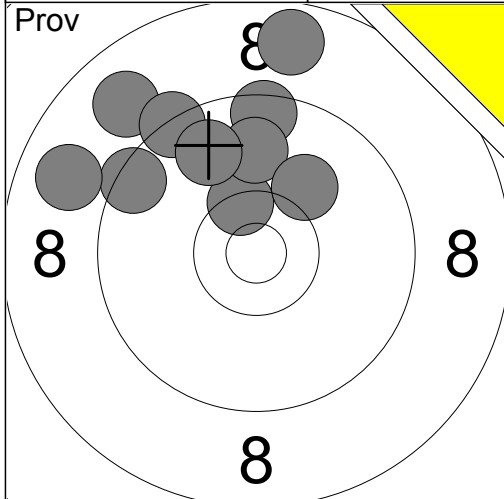

1:	8.9	↗
2:	9.3	↗
3:	8.7	↑
4:	9.5	↑
5:	10.4x	↑
6:	9.5	↗
7:	9.9	↑
8:	8.8	↖
9:	9.8	↗
10:	10.1	↗
Serie		89.0
Total		188.0

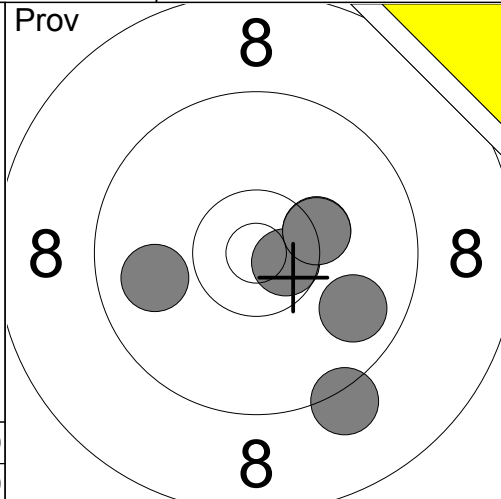

11:	9.8	↘
12:	10.6x	→
13:	9.2	↘
14:	10.3x	→
15:	10.3x	→
16:	9.9	←
Serie		57.0
Total		188.0

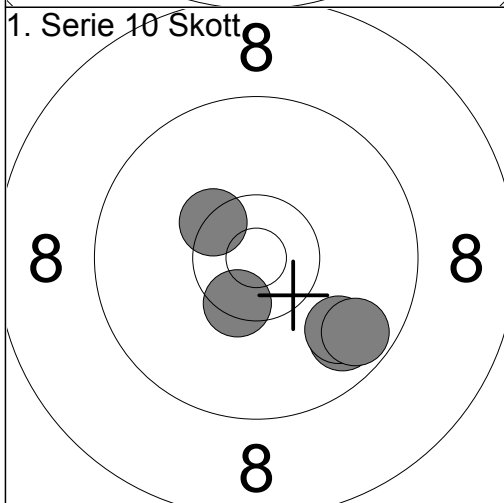

1:	9.7	↘
2:	10.4x	↘
3:	9.8	↘
4:	10.4x	↗
5:	9.7	↘
Serie		47.0
Total		235.0

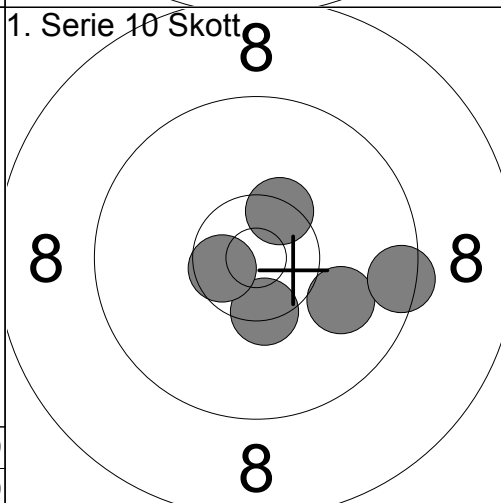

6:	10.0	↘
7:	9.5	→
8:	10.4x	↗
9:	10.4x	↘
10:	10.6x	←
Serie		49.0
Total		284.0

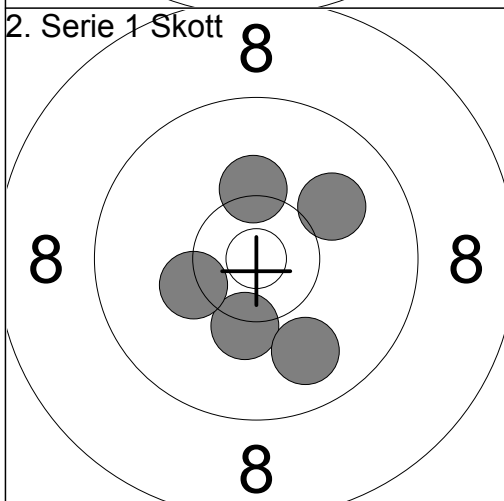

1:	10.0	↗
2:	10.2	↑
3:	10.3	↘
4:	9.9	↘
5:	10.3	←
Serie		49.0
Total		333.0

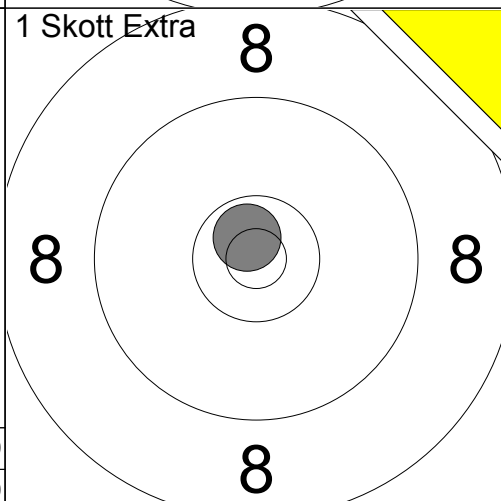

1:	10.7x	↖
Serie		10.0
Total		333.0

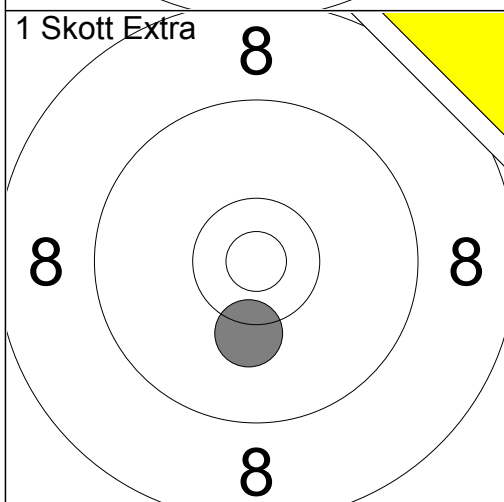

1:	10.2	↓
Serie		10.0
Total		333.0

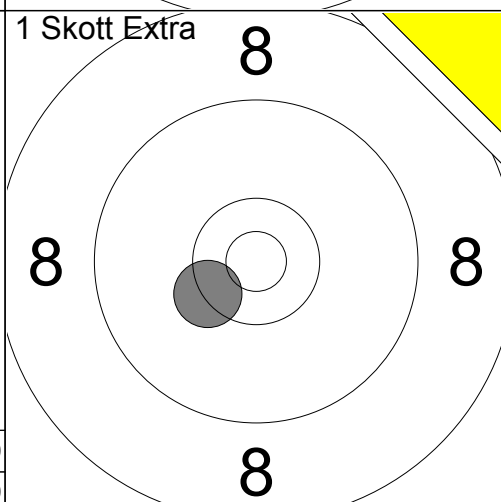

1:	10.4x	↖
Serie		10.0
Total		333.0

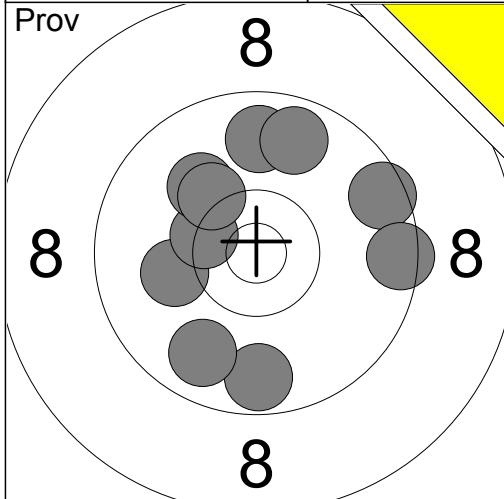

1:	9.8	↑
2:	9.7	↓
3:	10.1	←
4:	9.8	↓
5:	10.4x	←
6:	9.5	→
7:	10.1	↑
8:	9.5	→
9:	9.7	↑
10:	10.2	↑

Serie	94.0
Total	188.0

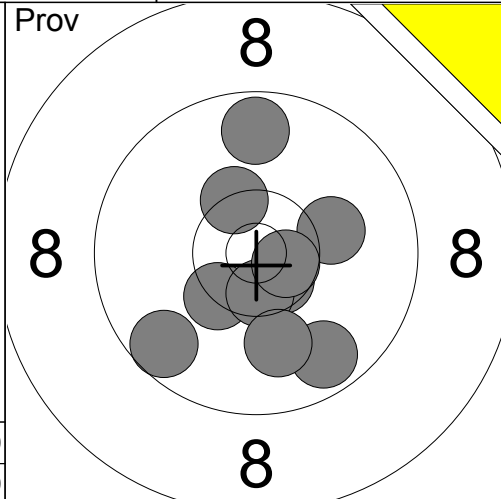

11:	9.6	↓
12:	10.4x	↑
13:	10.6x	↓
14:	10.4x	↓
15:	9.7	↓
16:	9.7	↑
17:	10.2	→
18:	10.5x	↓
19:	10.6x	→
20:	10.0	↓

Serie	97.0
Total	188.0

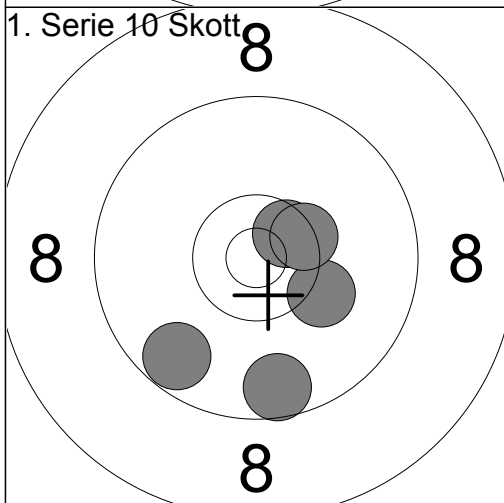

1:	10.6x	↗
2:	10.2	→
3:	9.7	↓
4:	10.4x	→
5:	9.6	↓

Serie	48.0
Total	236.0

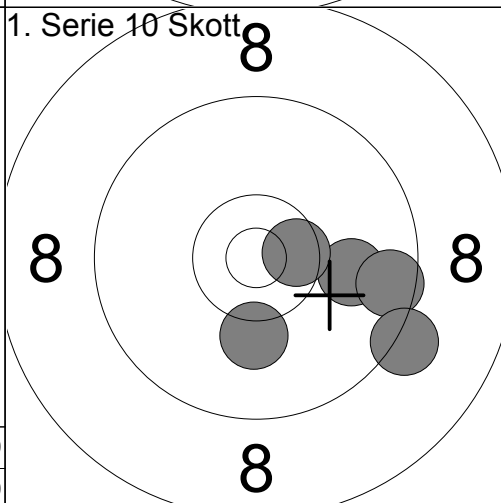

6:	10.2	↓
7:	10.0	→
8:	9.6	→
9:	9.2	↓
10:	10.5x	→

Serie	48.0
Total	284.0

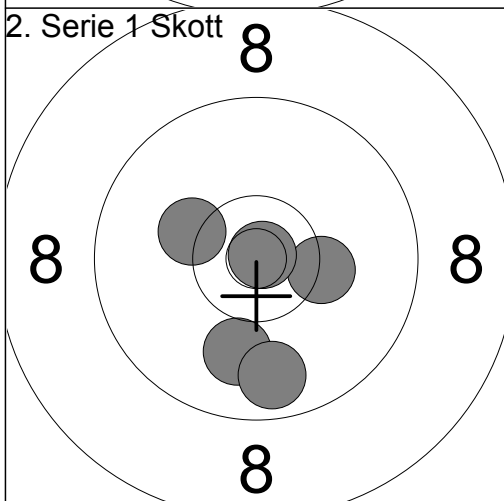

1:	10.3	→
2:	10.9x	↗
3:	10.0	↓
4:	9.7	↓
5:	10.2	↖

Serie	49.0
Total	333.0

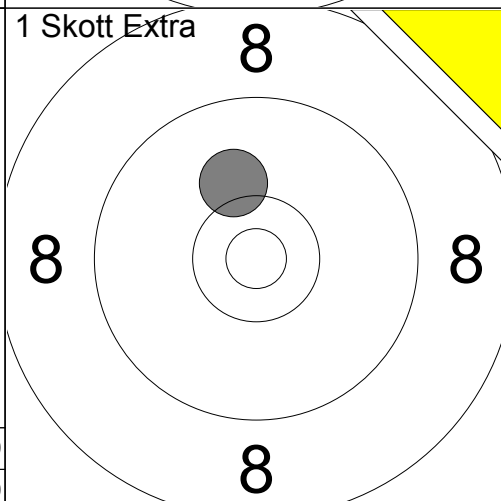

1:	10.1	↑
----	------	---

Serie	10.0
Total	333.0

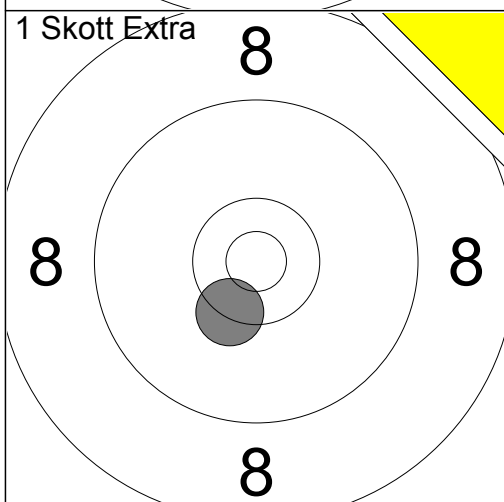

1:	10.4x	↓
----	-------	---

Serie	10.0
Total	333.0

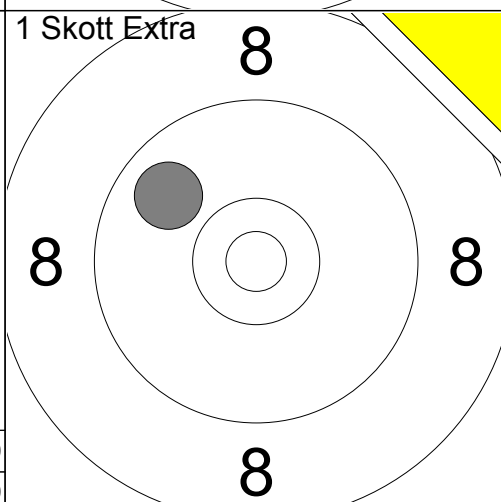

1:	9.8	↗
----	-----	---

Serie	9.0
Total	333.0

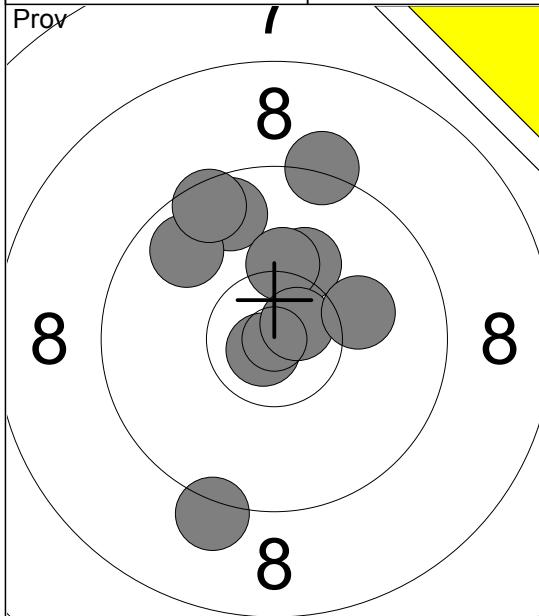

- 1: 9.7 ↗
- 2: 9.3 ↗
- 3: 9.8 ↖
- 4: 10.2 ↗
- 5: 10.2 ↗
- 6: 9.5 ↖
- 7: 10.8 ↘
- 8: 10.7 ↗
- 9: 9.2 ↓
- 10: 10.1 →

Serie 95.0

Total 199.0

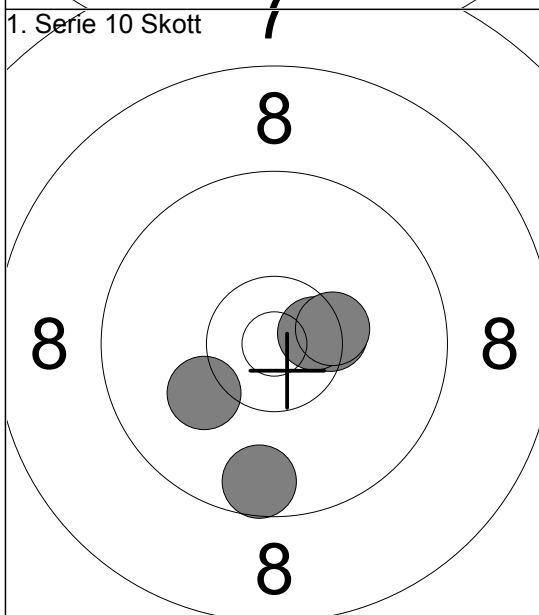

- 1: 10.1 ↖
- 2: 10.4x →
- 3: 10.6x →
- 4: 9.6 ↓
- 5: 10.4x →

Serie 49.0

Total 248.0

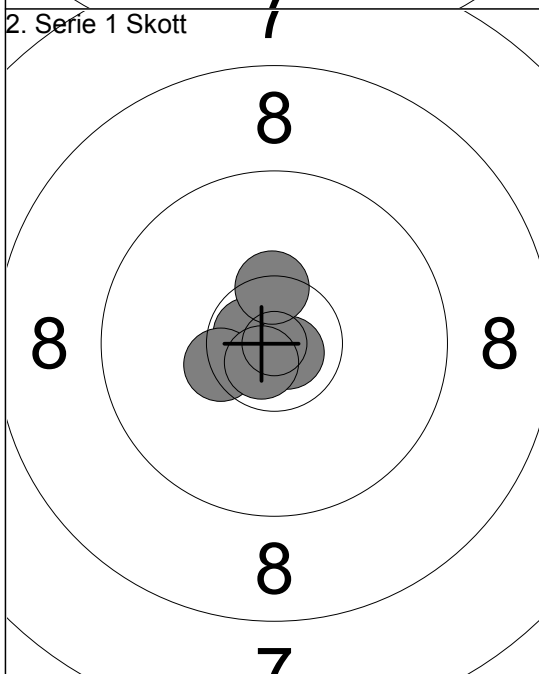

- 1: 10.7x ↖
- 2: 10.8x ↘
- 3: 10.4x ↗
- 4: 10.4x ↖
- 5: 10.7x ↘

Serie 50.0

Total 348.0

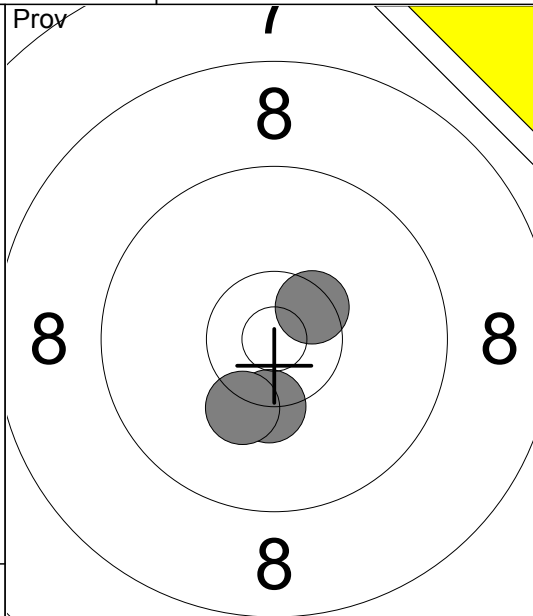

- 11: 10.3x ↓
- 12: 10.2 ↓
- 13: 10.5x ↗

Serie 30.0

Total 199.0

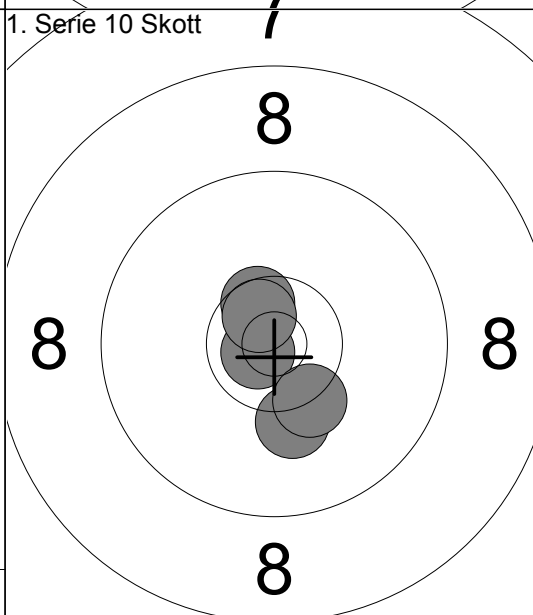

- 6: 10.5x ↗
- 7: 10.2 ↓
- 8: 10.8x ↖
- 9: 10.6x ↗
- 10: 10.3x ↘

Serie 50.0

Total 298.0

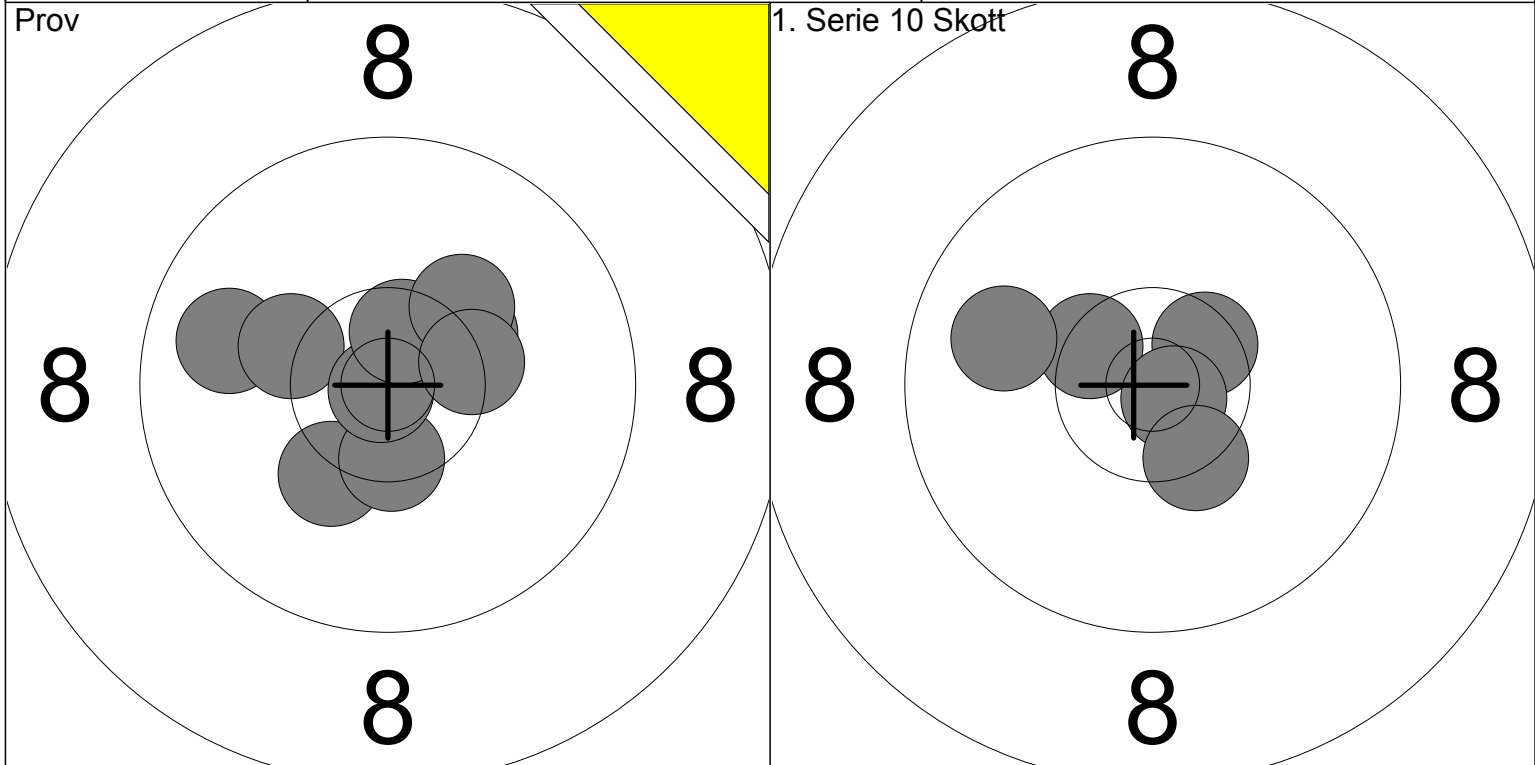

1: 10.2 ↘	6: 10.9x ↙	Serie 89	1: 10.5x ↖	Serie 49
2: 10.5x ↓	7: 10.6x ↗		2: 10.5x ↗	
3: 10.3x ↗	8: 10.2 ↗	Total 198	3: 9.9 ↖	Total 247
4: 9.9 ←	9: 10.4x →		4: 10.8x ↘	
5: 10.3 ←			5: 10.4x ↘	

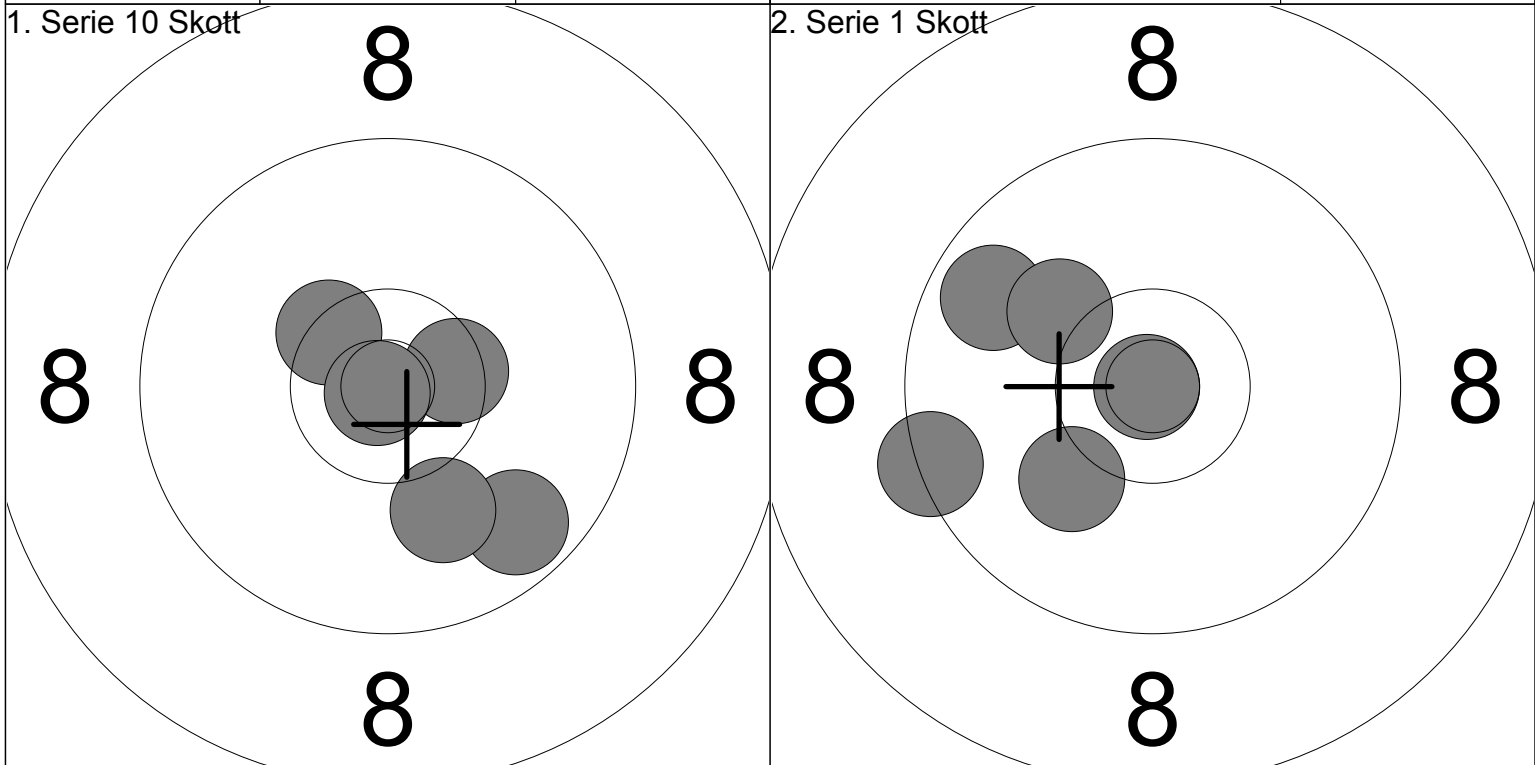

6: 10.5x →	Serie 49	1: 10.1 ↘	Serie 48
7: 9.7 ↘		2: 9.7 ↖	
8: 10.0 ↘	Total 296	3: 10.2 ↖	Total 344
9: 10.4x ↗		4: 10.9x ←	
10: 10.9x ↙		5: 9.4 ←	

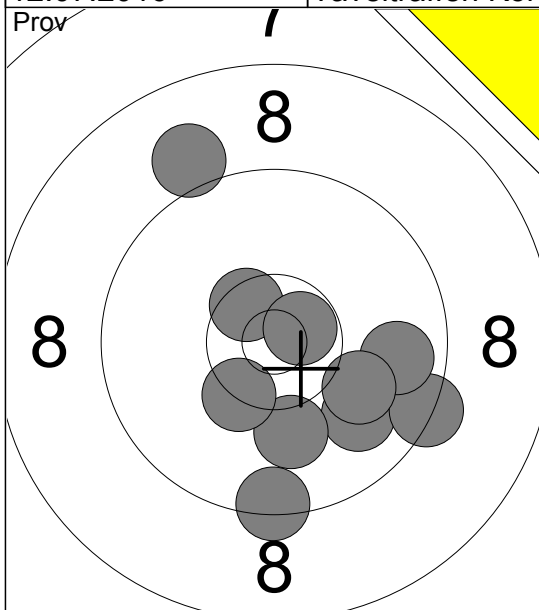

- 1: 9.9 ↘
- 2: 9.4 ↓
- 3: 10.1 ↓
- 4: 9.4 →
- 5: 10.5x ↘
- 6: 9.8 →
- 7: 10.3x ↘
- 8: 9.0 ↗
- 9: 10.0 ↘
- 10: 10.7x ↗

Serie 95.0

Total 197.0

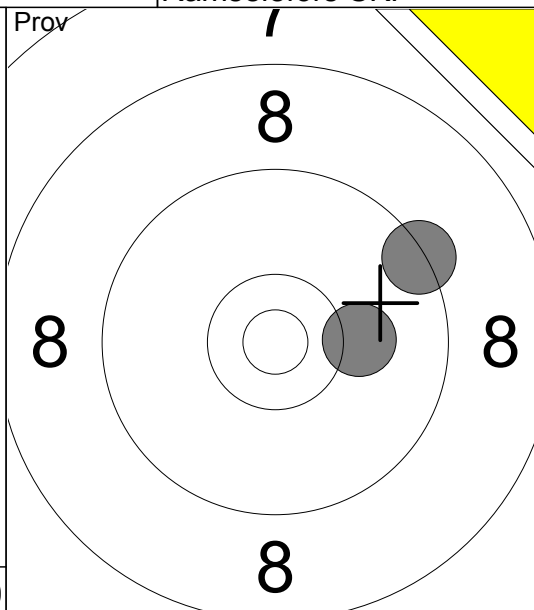

- 11: 10.2 →
- 12: 9.4 ↗

Serie 19.0

Total 197.0

1. Serie 10 Skott

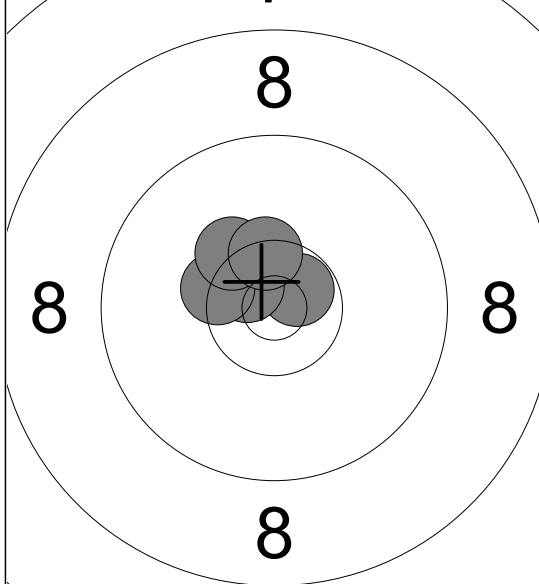

- 1: 10.7x ↗
- 2: 10.6x ↘
- 3: 10.4x ↘
- 4: 10.3x ↘
- 5: 10.4x ↗

Serie 50.0

Total 247.0

1. Serie 10 Skott

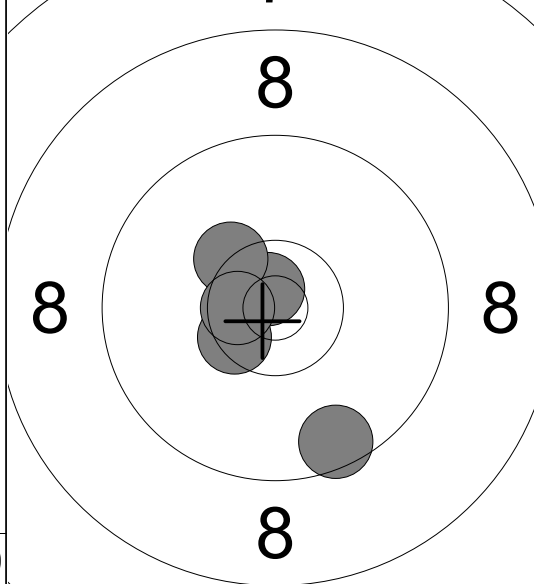

- 6: 10.5x ↘
- 7: 10.8x ↗
- 8: 10.3x ↘
- 9: 10.6x ↘
- 10: 9.5 ↓

Serie 49.0

Total 296.0

2. Serie 1 Skott

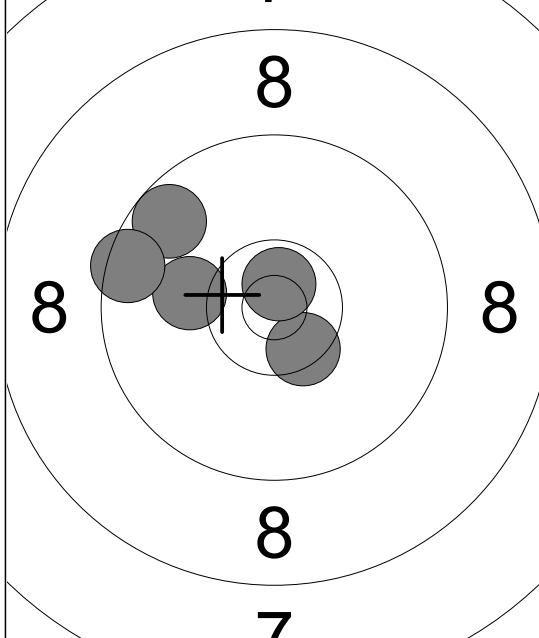

- 1: 10.5x ↘
- 2: 10.1 ←
- 3: 9.7 ↗
- 4: 10.7x ↗
- 5: 9.5 ←

Serie 48.0

Total 344.0

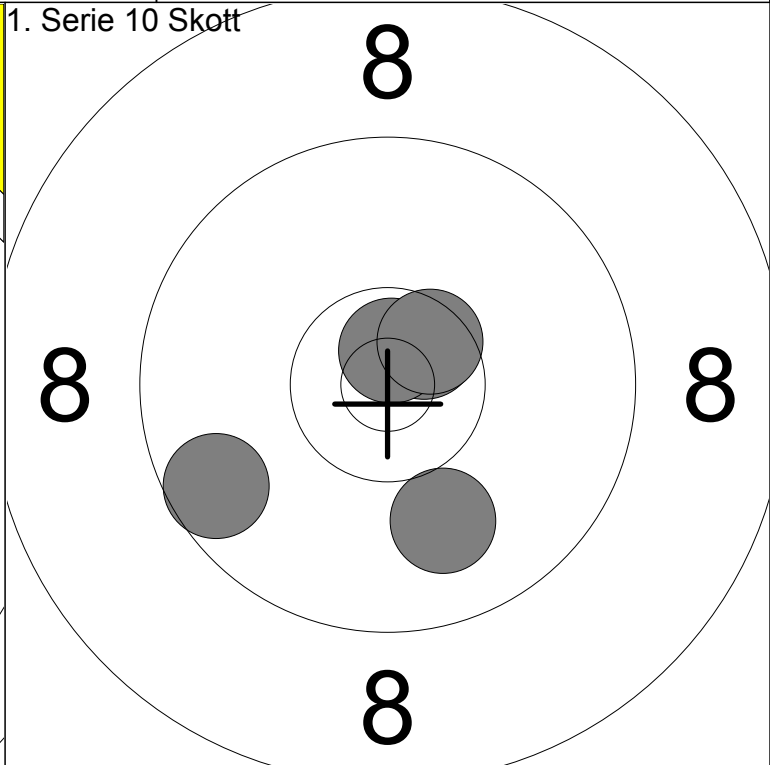
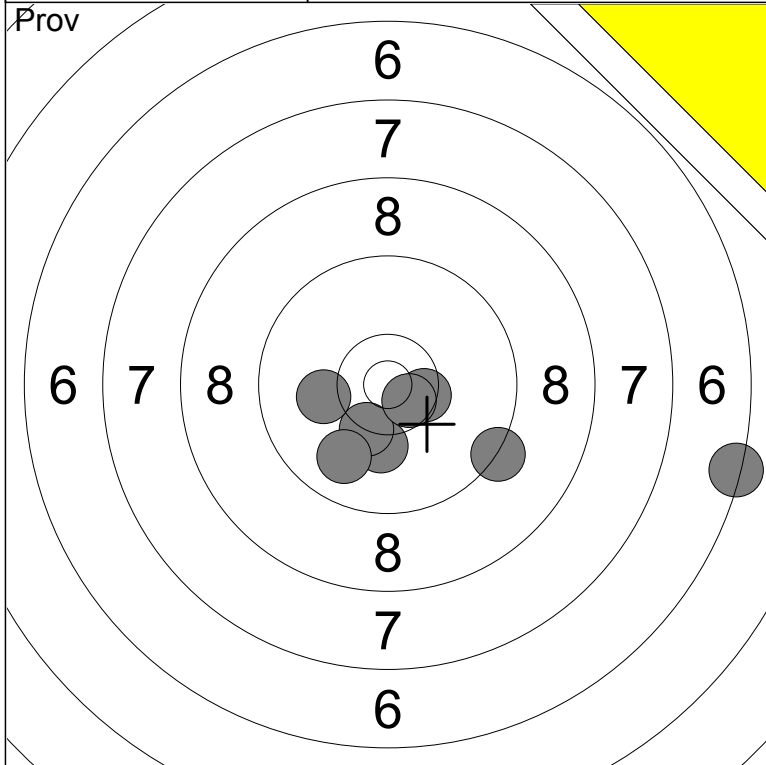

1: 10.2 ↓	6: 9.9 ↘	Serie	74
2: 10.3x ↘	7: 6.4 →		
3: 10.1 ←	8: 9.3 ↘	Total	196
4: 10.5x →			
5: 10.6x ↘			

1: 10.6x ↗	Serie	49
2: 9.6 ↙		
3: 10.7x ↑	Total	245
4: 10.0 ↓		
5: 10.5x ↗		

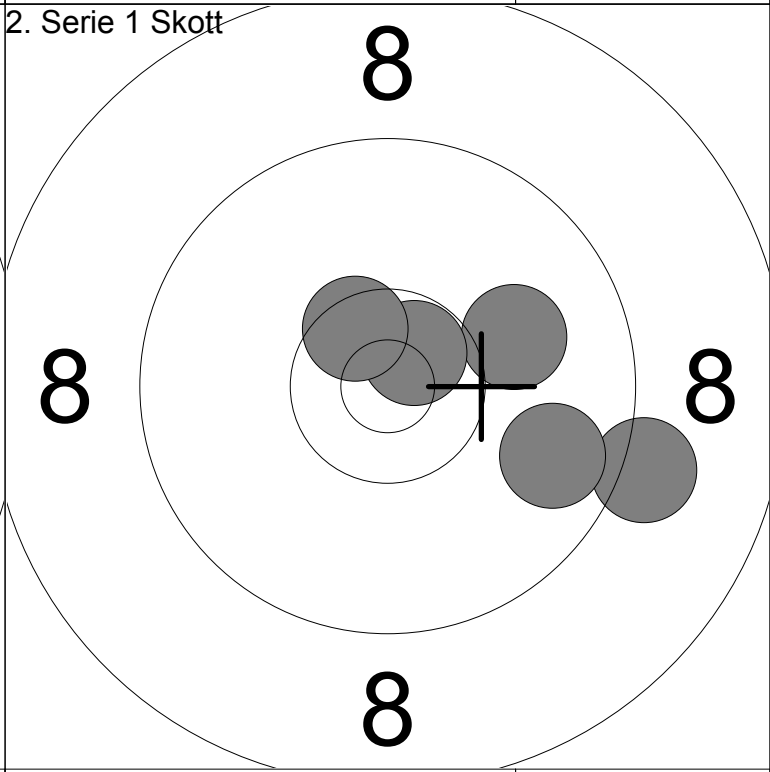
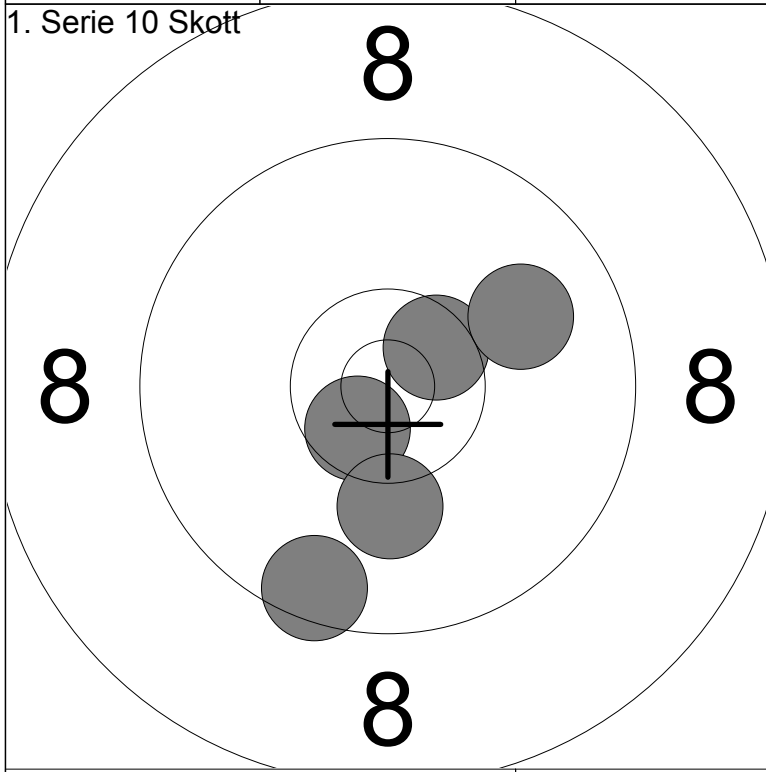

6: 10.6x ↘	Serie	48
7: 10.5x ↗		
8: 10.2 ↓	Total	293
9: 9.9 ↗		
10: 9.5 ↓		

1: 10.0 →	Serie	48
2: 9.2 →		
3: 10.7x ↗	Total	341
4: 9.8 →		
5: 10.5x ↗		

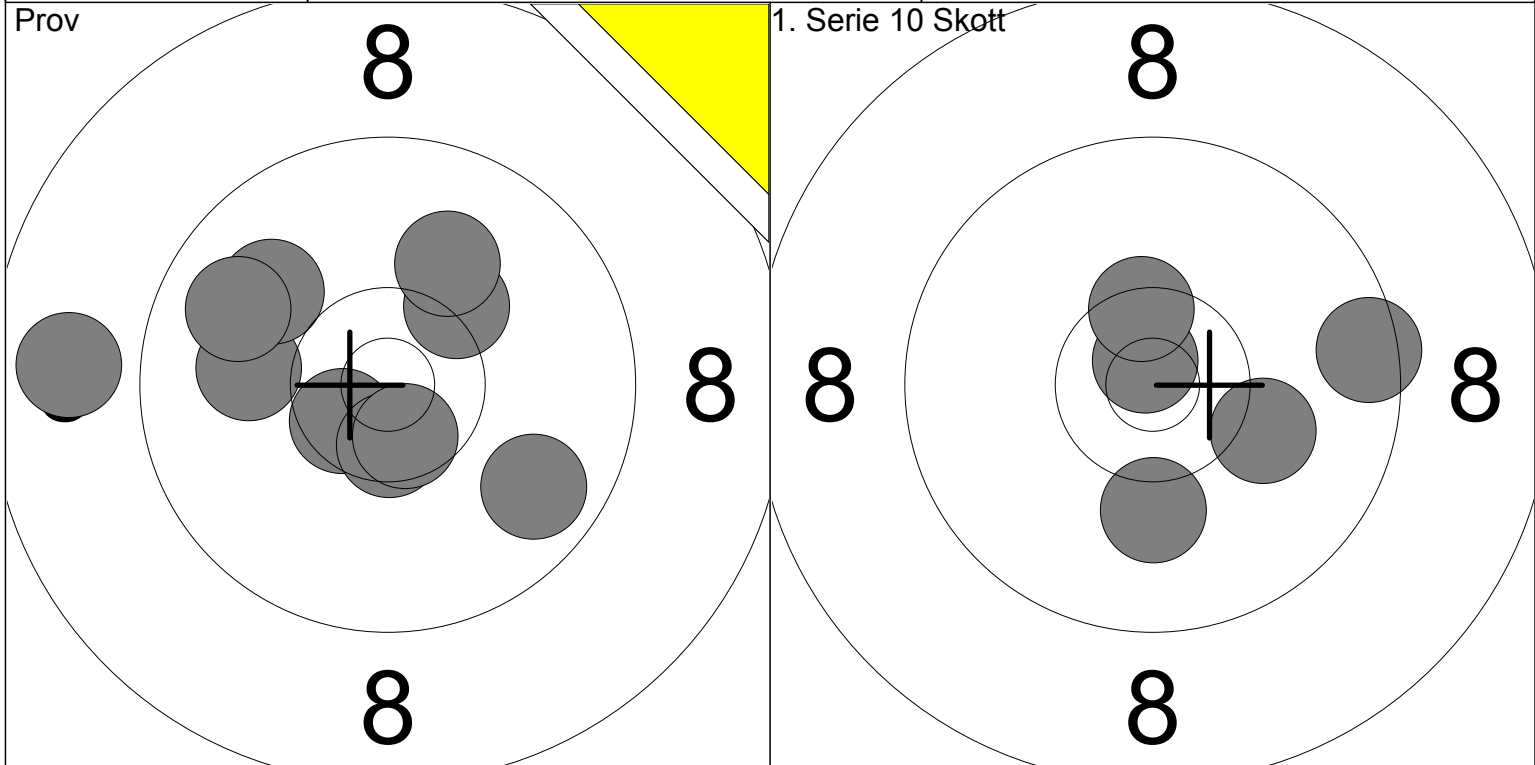

1: 10.0 ←	6: 9.8 ←	Serie 96	1: 10.1 ↓	Serie 49
2: 9.8 ↘	7: 10.3 ↗		2: 10.8x ↑	
3: 10.0 ↗	8: 10.5x ↓	Total 195	3: 10.2 →	Total 244
4: 10.6x ←	9: 10.1 ↗		4: 10.4x ↑	
5: 8.8 ←	10: 10.6x ↓		5: 9.5 →	

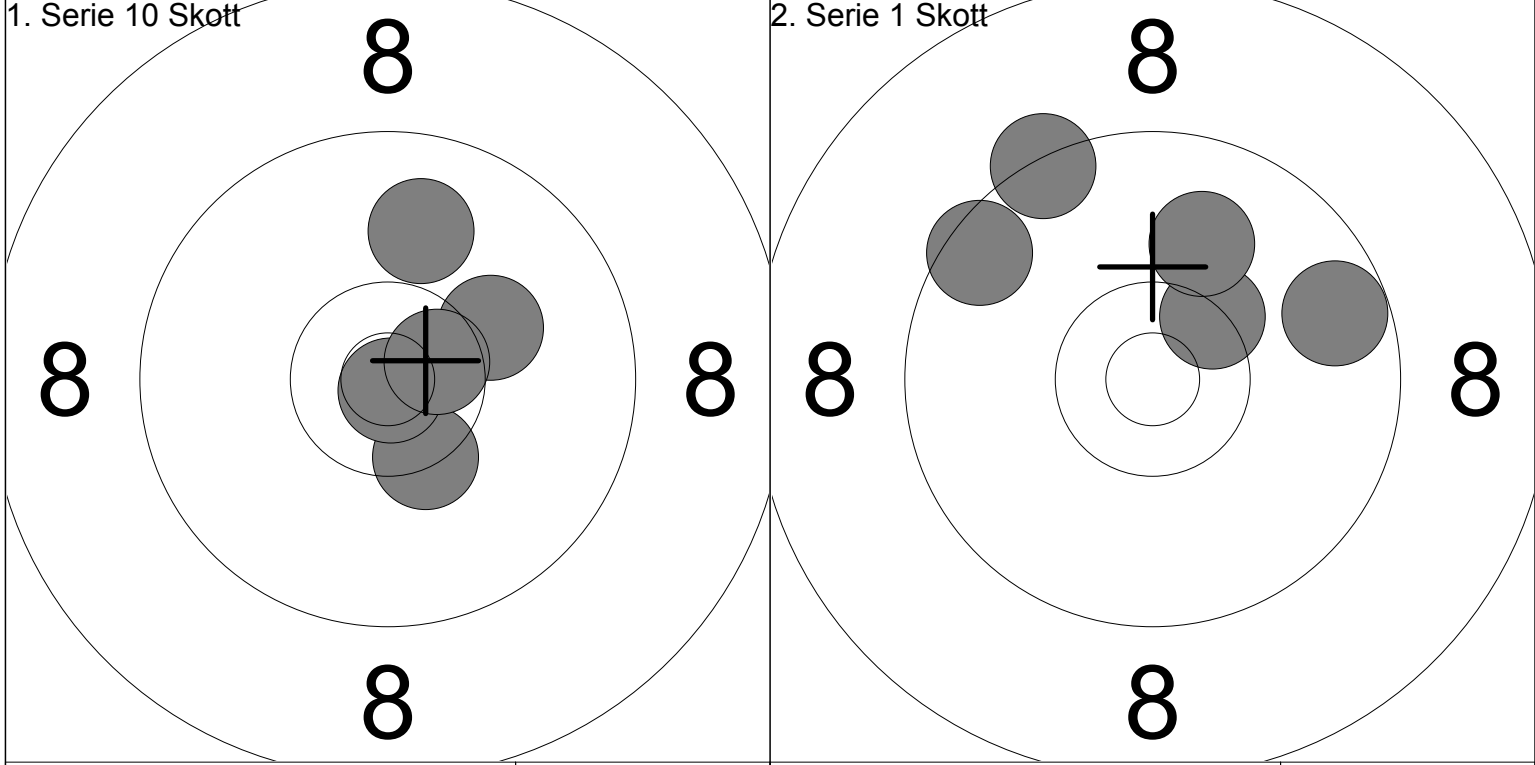

6: 10.4x ↓	Serie 49	1: 9.4 ↗	Serie 47
7: 10.9x ↓		2: 9.7 →	
8: 10.2 ↗	Total 293	3: 10.4x ↗	Total 340
9: 10.6x →		4: 10.0 ↑	
10: 9.9 ↑		5: 9.5 ↖	

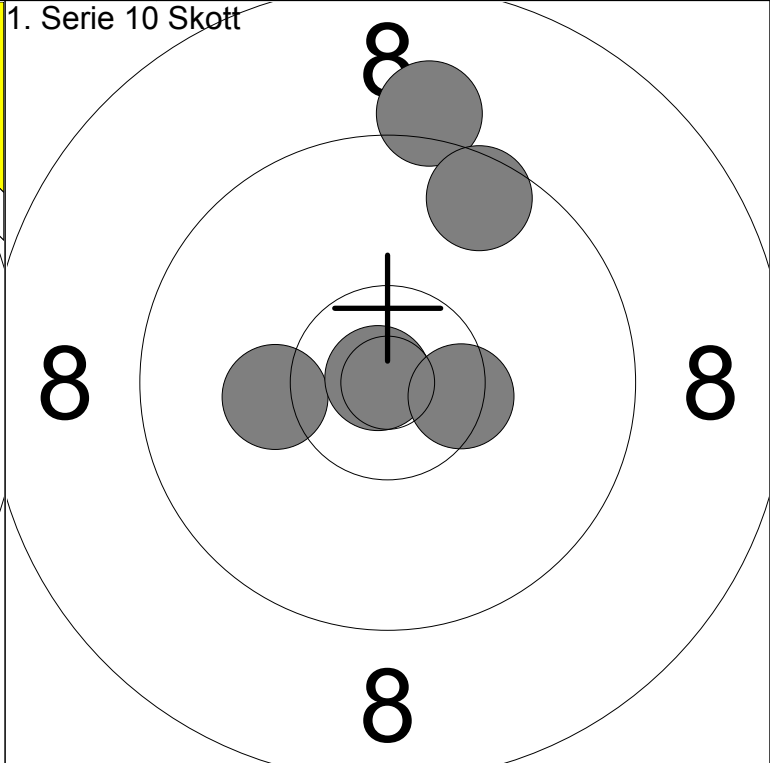
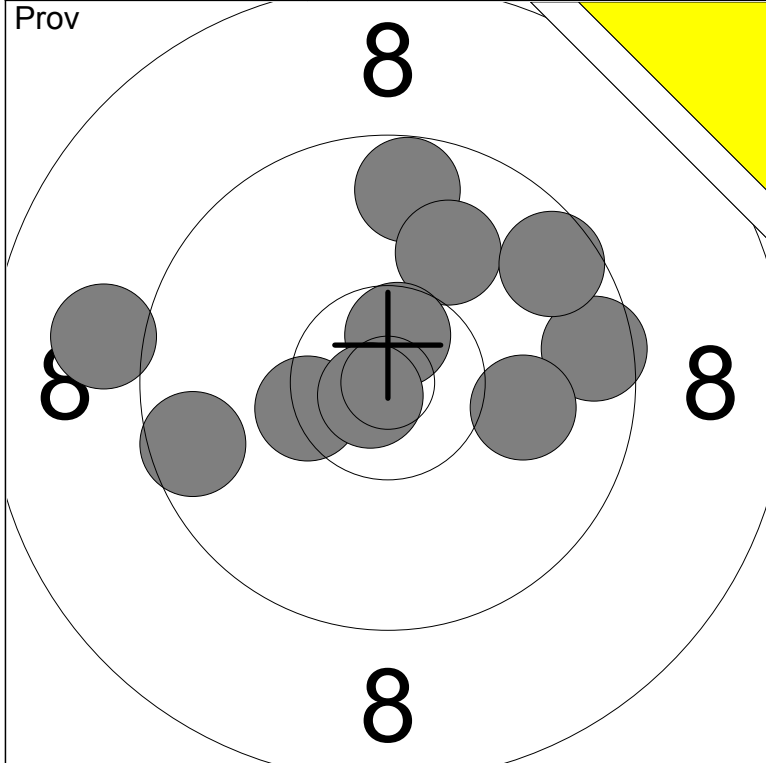

1: 9.6 ←	6: 9.6 →	Serie	95
2: 9.0 ←	7: 10.6x ↑		
3: 9.7 ↑	8: 9.6 ↗	Total	193
4: 10.0 ↗	9: 10.0 →		
5: 10.4x ←	10: 10.8x ↙		

1: 10.2 ←	Serie	48
2: 10.9x ↙		
3: 9.1 ↑	Total	241
4: 9.6 ↗		
5: 10.5x →		

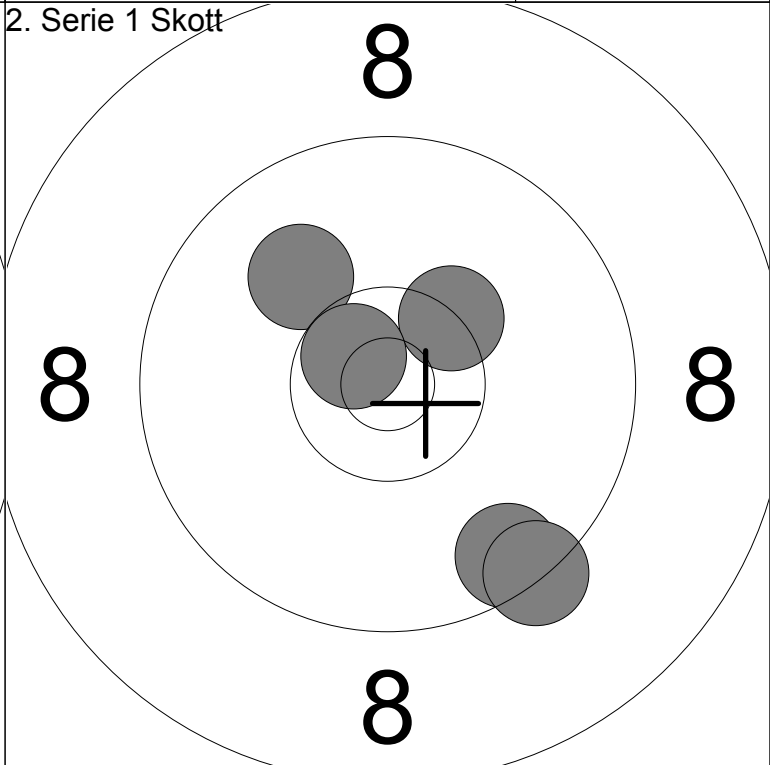
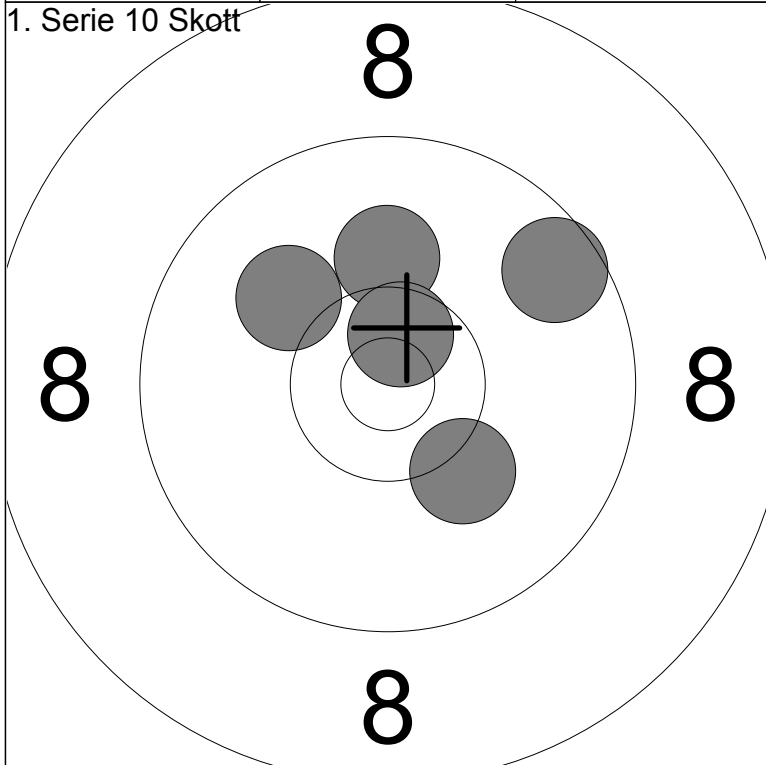

6: 9.6 ↗	Serie	49
7: 10.1 ↑		
8: 10.2 ↘	Total	290
9: 10.1 ↖		
10: 10.6x ↑		

1: 9.6 ↘	Serie	48
2: 9.3 ↘		
3: 10.0 ↗	Total	338
4: 10.3x ↗		
5: 10.7x ↖		

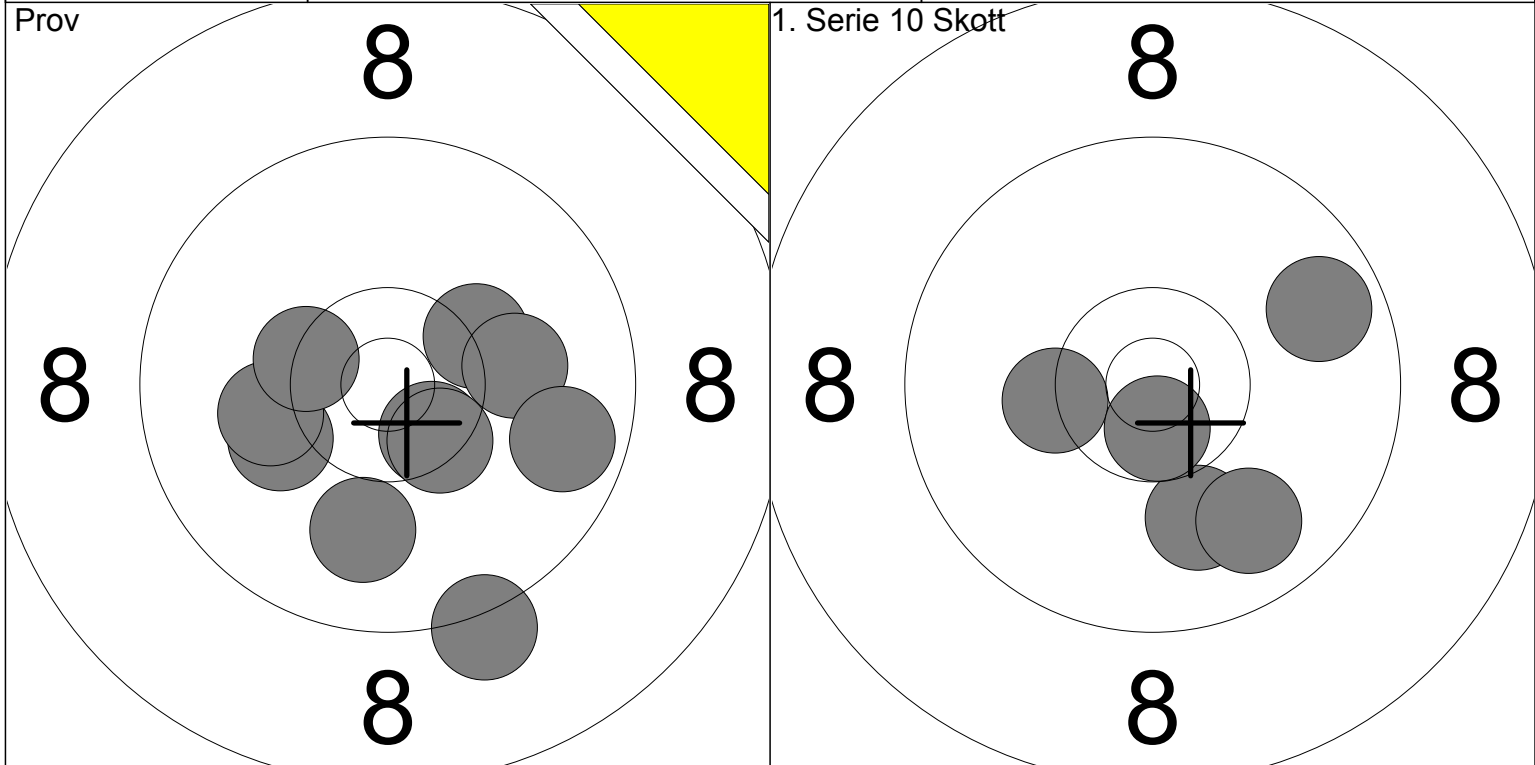

1: 10.3 ↗	6: 10.1 ←	Serie 98	1: 9.7 ↗	Serie 48
2: 10.0 ↓	7: 10.4x ↓		2: 10.0 ↓	
3: 10.1 →	8: 9.2 ↙	Total 193	3: 10.3x ←	Total 241
4: 10.5x ↓	9: 9.7 ↘		4: 10.7x ↓	
5: 10.2 ↖	10: 10.4x ↖		5: 9.8 ↘	

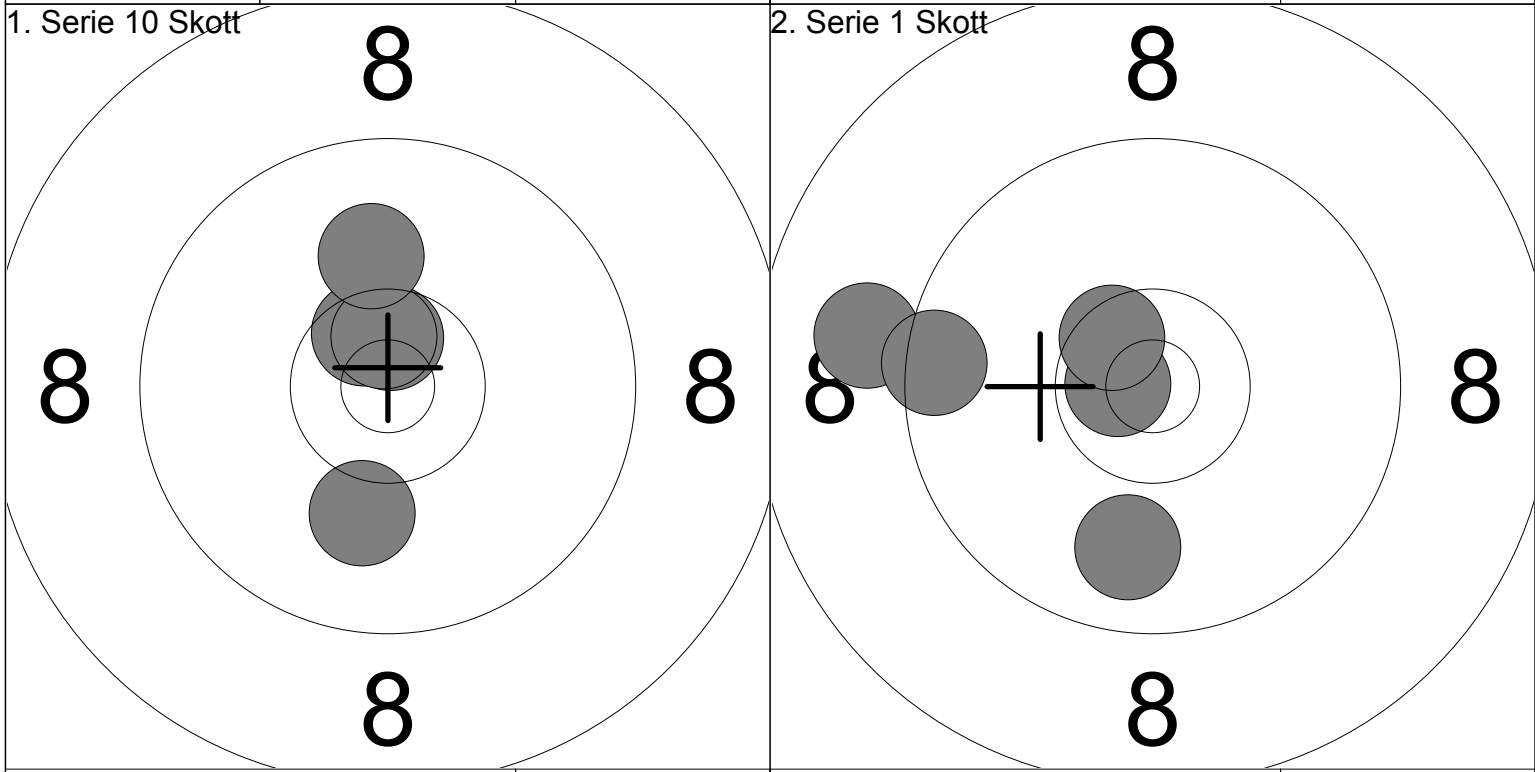

6: 10.6x ↑	Serie 50	1: 10.7x ←	Serie 47
7: 10.6x ↖		2: 10.5x ↖	
8: 10.6x ↑	Total 291	3: 9.9 ↓	Total 338
9: 10.1 ↑		4: 9.0 ←	
10: 10.1 ↓		5: 9.5 ←	

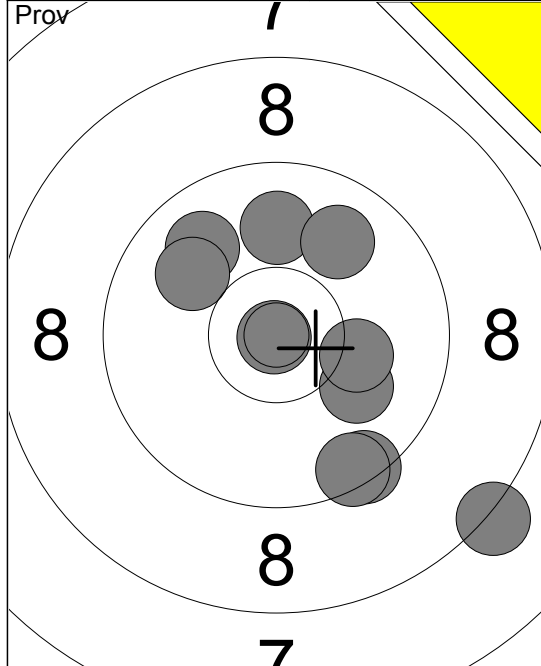

1:	10.0	↘
2:	10.9	✘
3:	9.9	↗
4:	9.9	↑
5:	10.0	↖
6:	9.9	↗
7:	9.4	↘
8:	8.2	↘
9:	9.5	↘
10:	10.2	→
Serie		93.0
Total		193.0

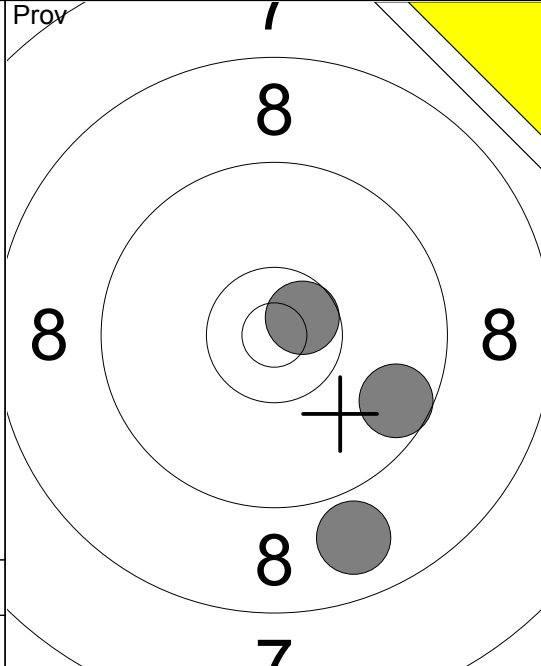

11:	9.6	↘
12:	8.9	↘
13:	10.6	↗
Serie		27.0
Total		193.0

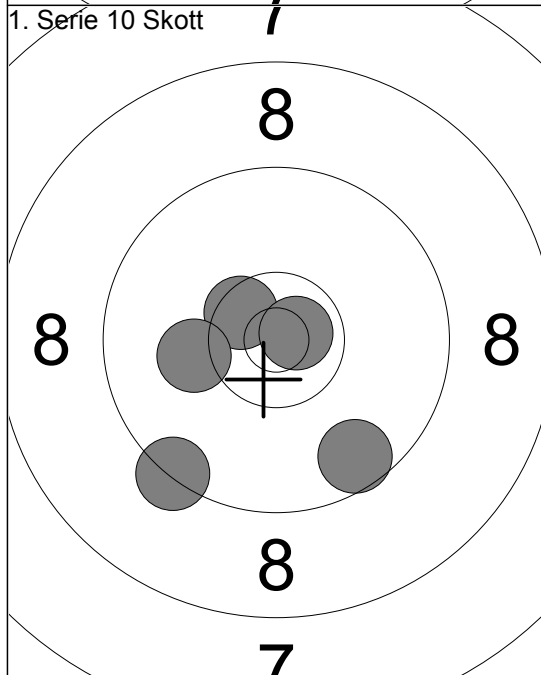

1:	9.3	↘
2:	10.5	✘
3:	10.1	←
4:	9.6	↘
5:	10.8	↗
Serie		48.0
Total		241.0

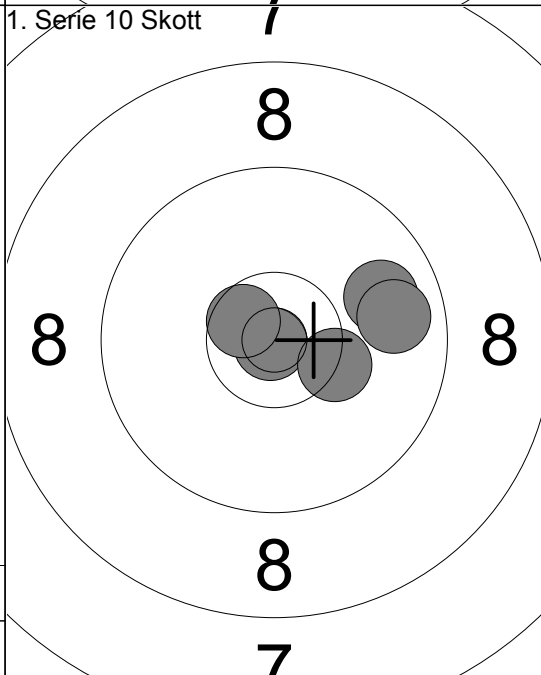

6:	9.9	↗
7:	10.9	✘
8:	9.8	→
9:	10.6	✘
10:	10.3	↗
Serie		48.0
Total		289.0

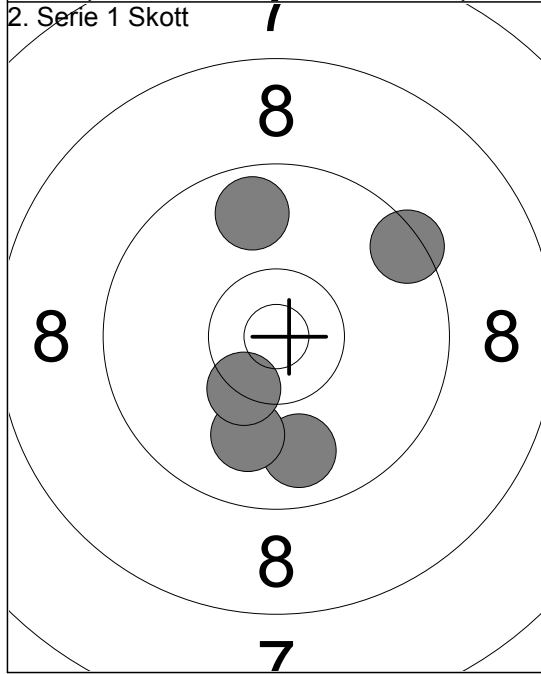

1:	9.8	↓
2:	10.0	↓
3:	10.4	✘
4:	9.4	↗
5:	9.8	↑
Serie		47.0
Total		336.0

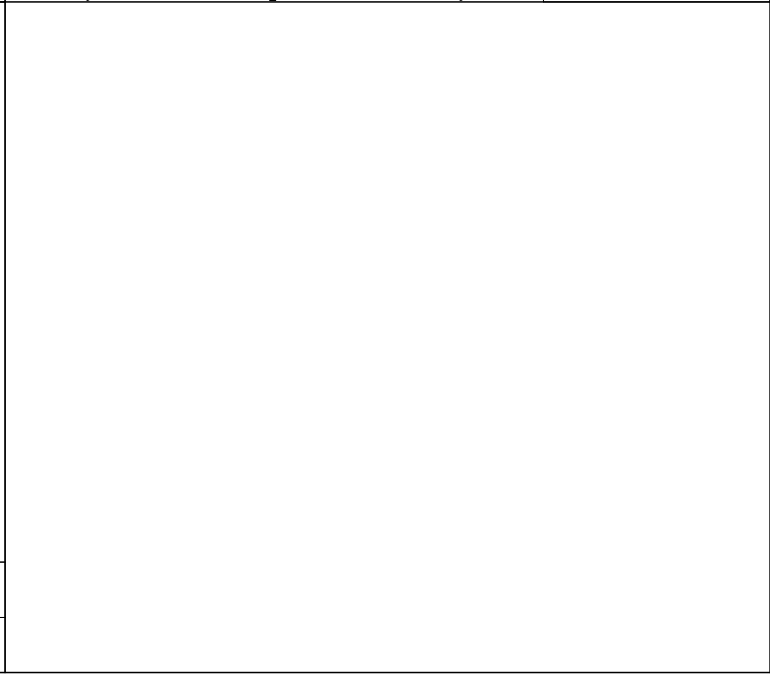

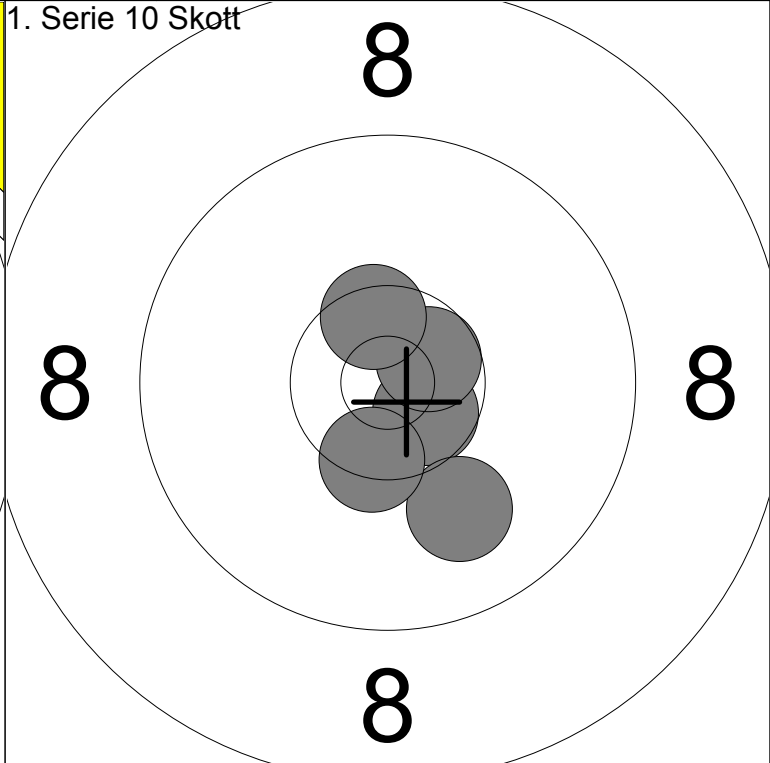
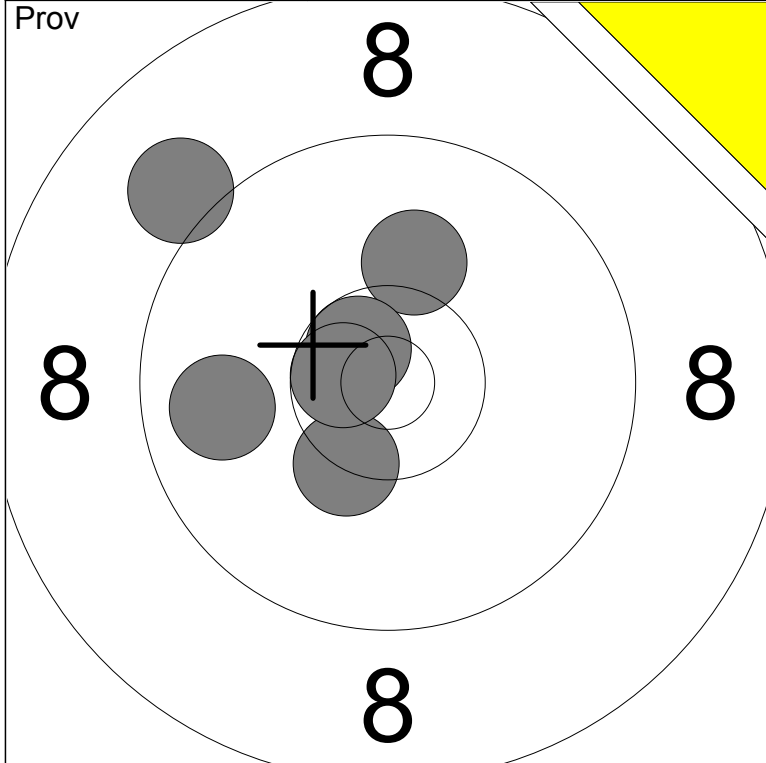

1: 9.1 ↗	6: 10.6x ←	Serie	58
2: 9.8 ←		Total	192
3: 10.3x ↘			
4: 10.1 ↑			
5: 10.6x ↖			

1: 10.6x ↘	Serie	50
2: 10.6x ↗	Total	242
3: 10.0 ↘		
4: 10.4x ↘		
5: 10.5x ↑		

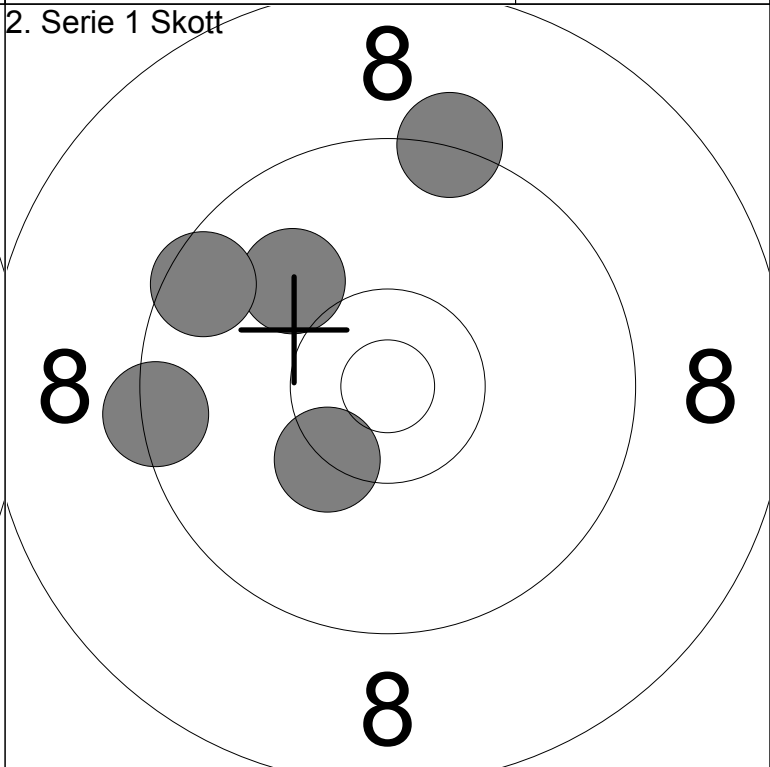
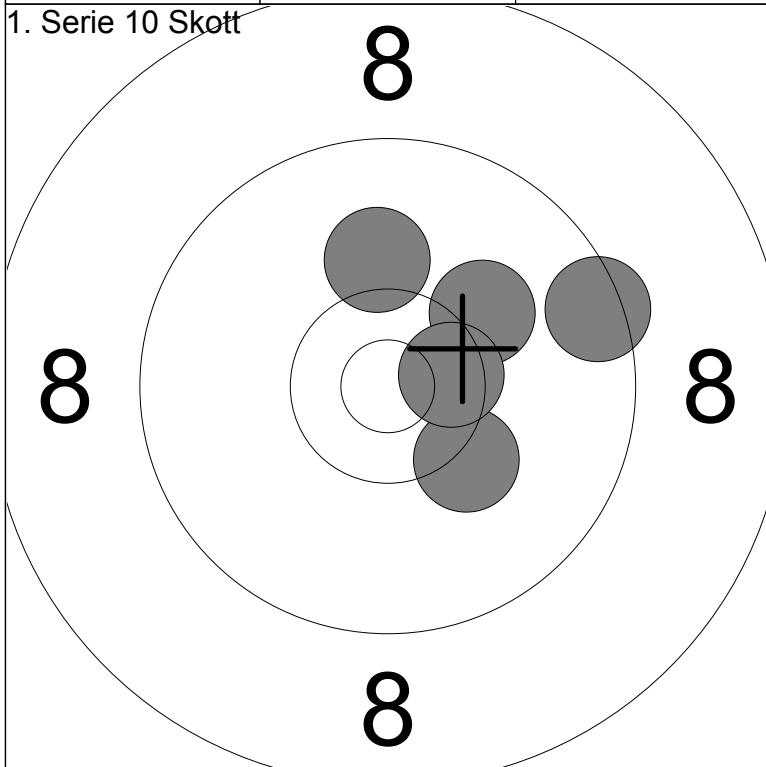

6: 10.2 ↘	Serie	49
7: 9.5 →	Total	291
8: 10.2 ↗		
9: 10.5x →		
10: 10.1 ↑		

1: 9.3 ↑	Serie	47
2: 10.0 ↖	Total	338
3: 9.4 ←		
4: 10.3x ↘		
5: 9.6 ↖		

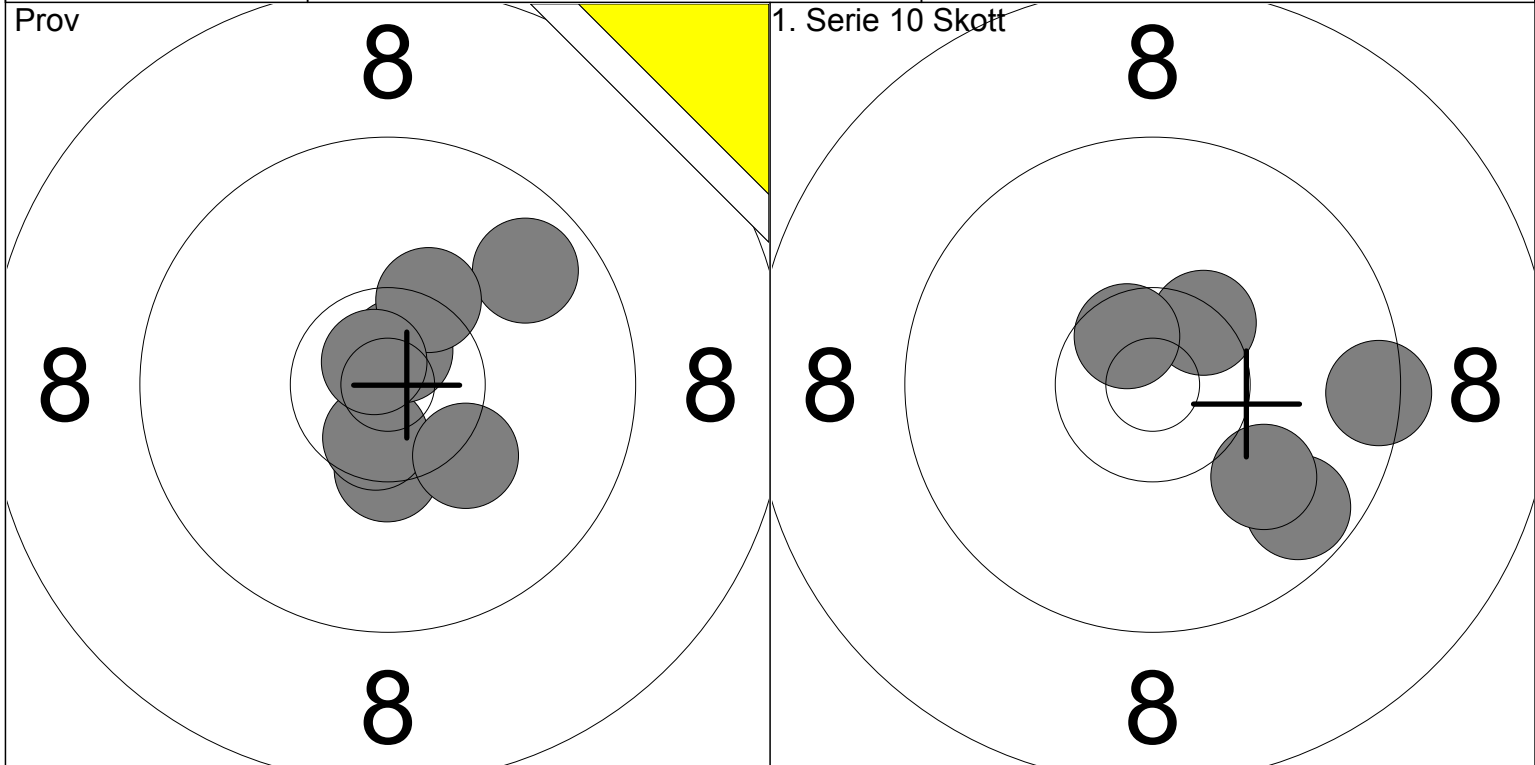

1: 9.8 ↗	6: 10.8x ↗	Serie 69	1: 10.4x ↗	Serie 48
2: 10.4x ↓	7: 10.2 ↘		2: 9.4 →	
3: 10.6x ↓		Total 192	3: 9.7 ↘	Total 240
4: 10.7x ↗			4: 10.0 ↘	
5: 10.3x ↗			5: 10.6x ↗	

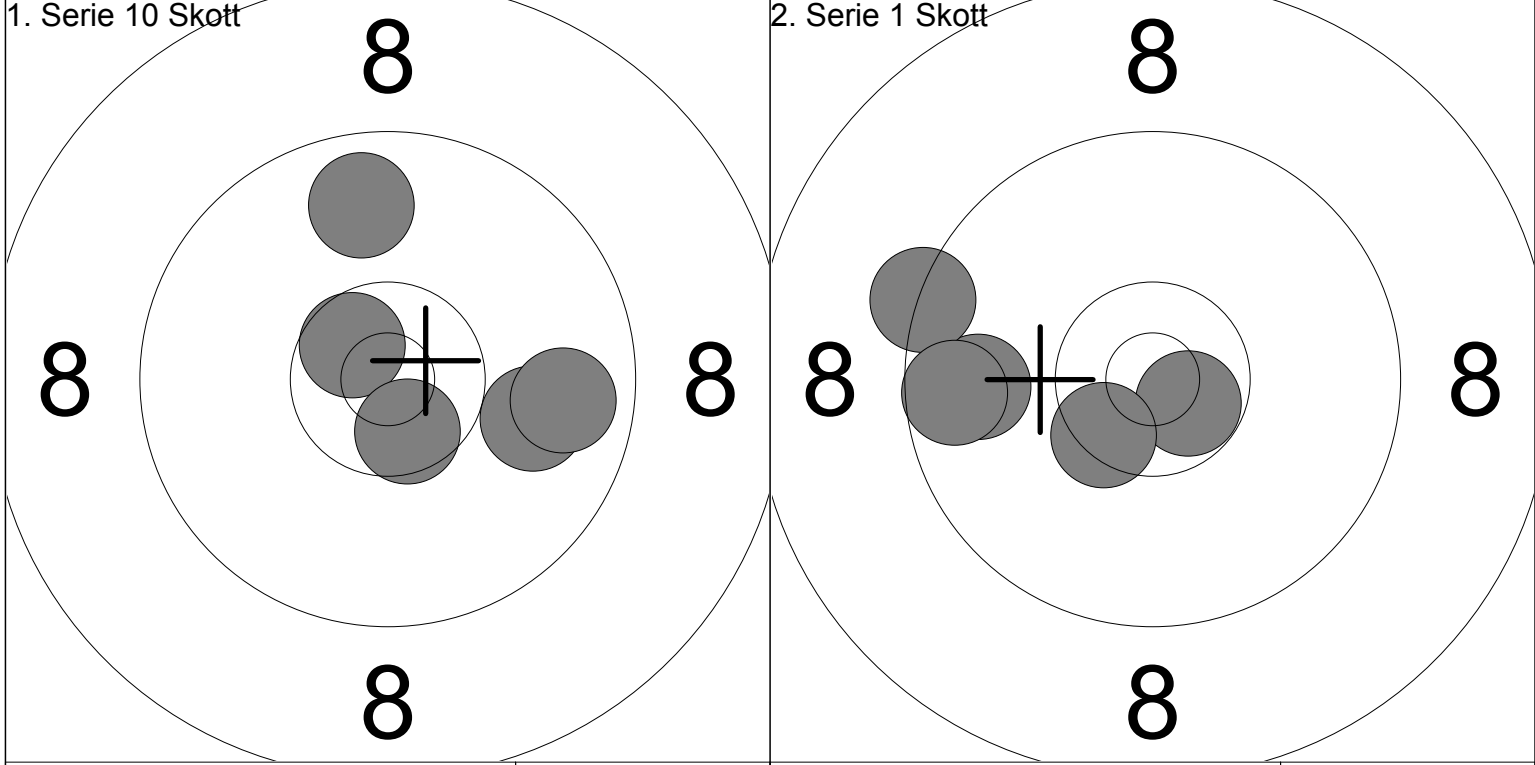

6: 9.8 ↑	Serie 48	1: 9.8 ←	Serie 47
7: 10.0 →		2: 10.7x ↘	
8: 10.6x ↗	Total 288	3: 9.3 ←	Total 335
9: 9.8 →		4: 10.5x ↘	
10: 10.6x ↓		5: 9.6 ←	

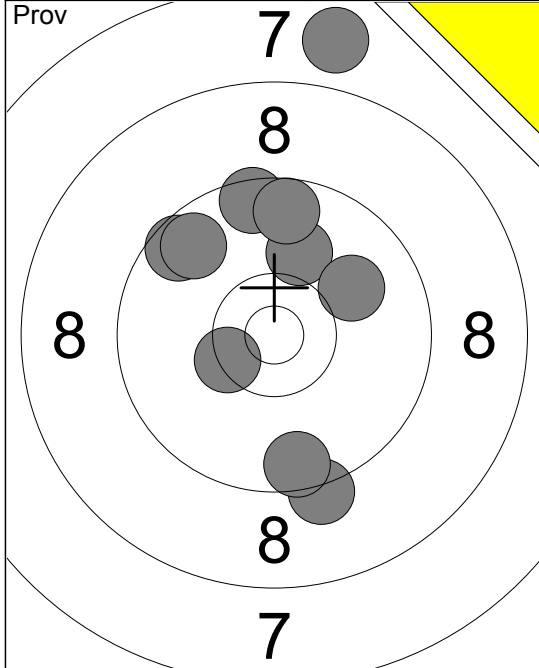

1:	10.0	↗
2:	7.8	↑
3:	9.6	↖
4:	9.5	↑
5:	9.7	↖
6:	10.0	↗
7:	9.6	↑
8:	10.4	✕
9:	9.2	↓
10:	9.6	↓
Serie		91.0
Total		191.0

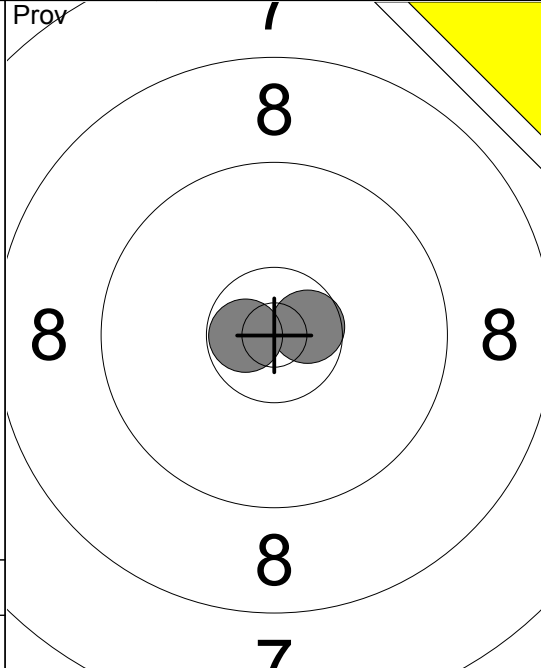

11:	10.6	✕➤
12:	10.7	✕←
Serie		20.0
Total		191.0

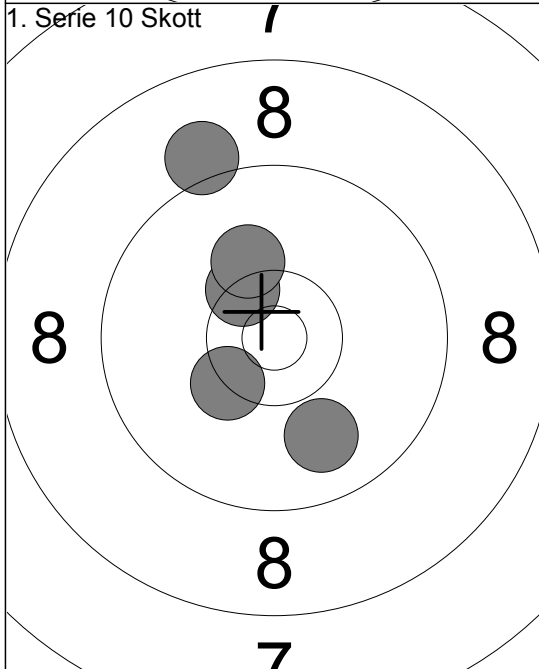

1:	9.1	↗
2:	10.3	✕
3:	9.9	↓
4:	10.4	✕
5:	10.2	↗
Serie		48.0
Total		239.0

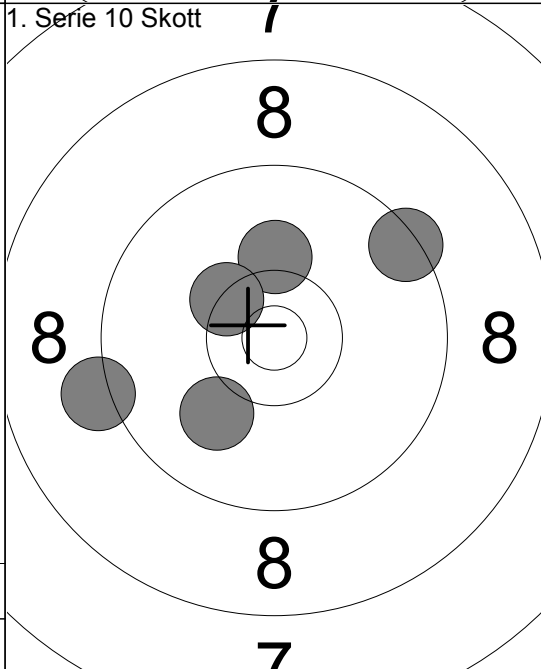

6:	10.2	↑
7:	9.4	↗
8:	10.0	↓
9:	10.4	✕
10:	9.2	←
Serie		48.0
Total		287.0

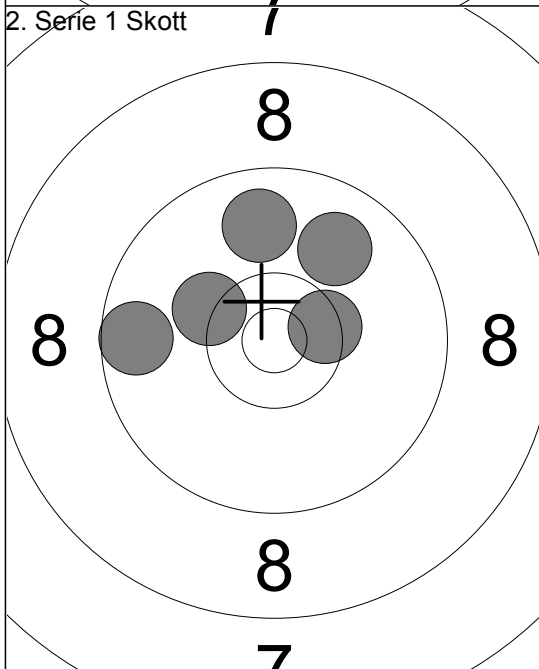

1:	9.9	↗
2:	10.5	✕➤
3:	10.3	↖
4:	9.8	↑
5:	9.6	←
Serie		47.0
Total		334.0

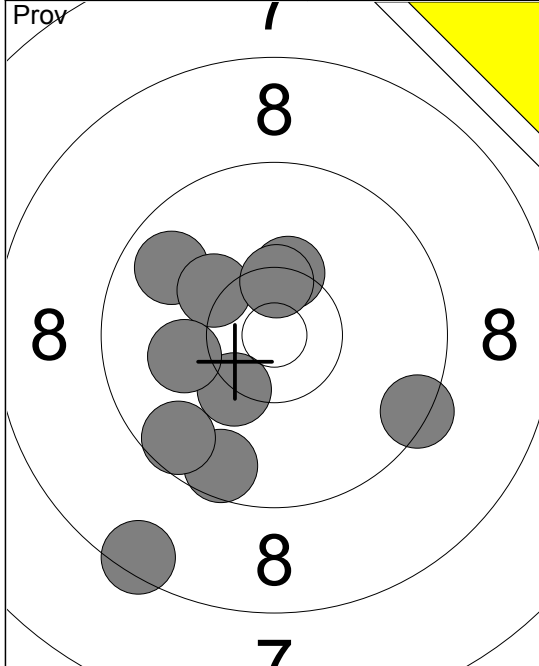

1:	9.8	↖
2:	8.5	↘
3:	9.6	↘
4:	10.3	↗x
5:	10.3	↘
6:	10.2	↖
7:	10.1	←
8:	9.6	↘
9:	9.4	↘
10:	10.4	↗x
Serie	94.0	
Total	191.0	

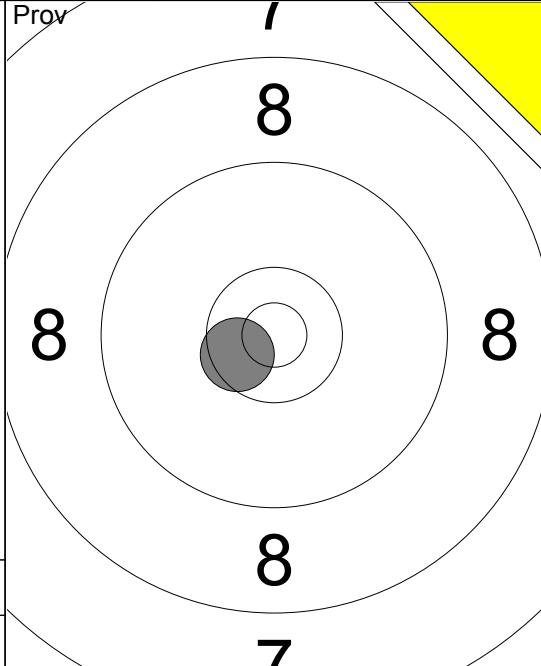

11:	10.6	↘
Serie	10.0	
Total	191.0	

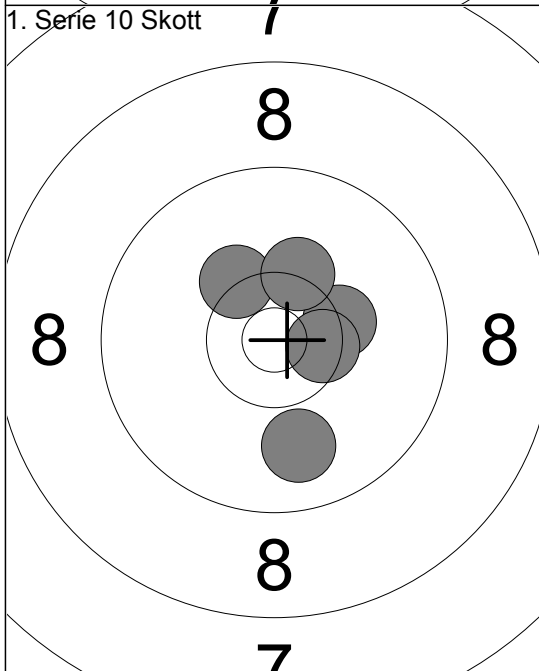

1:	10.3	↖
2:	9.9	↘
3:	10.3	↗x
4:	10.5	↗x
5:	10.3	↗
Serie	49.0	
Total	240.0	

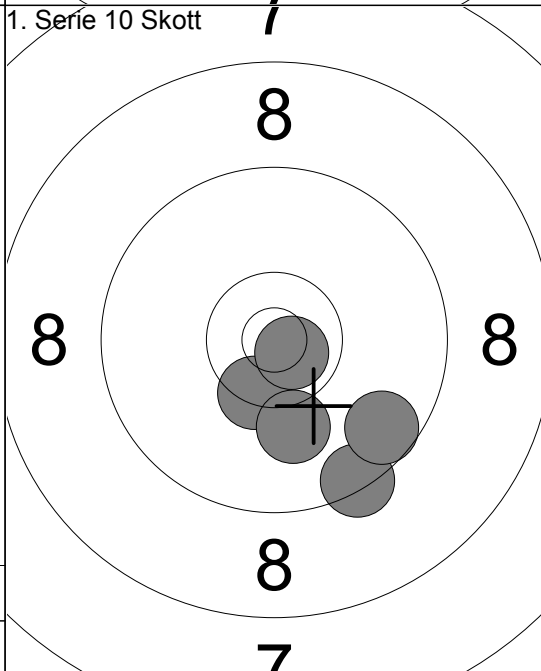

6:	9.4	↘
7:	9.6	↘
8:	10.4	↘
9:	10.1	↘
10:	10.7	↘
Serie	48.0	
Total	288.0	

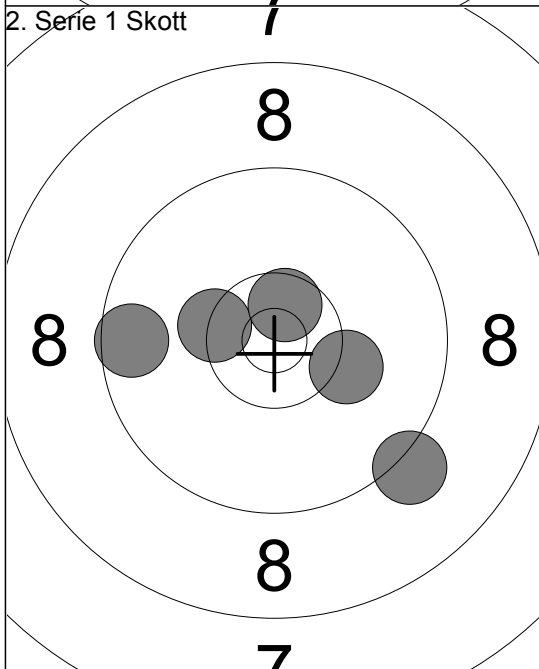

1:	10.2	↗
2:	9.6	←
3:	9.2	↘
4:	10.4	↖
5:	10.6	↗x
Serie	48.0	
Total	336.0	

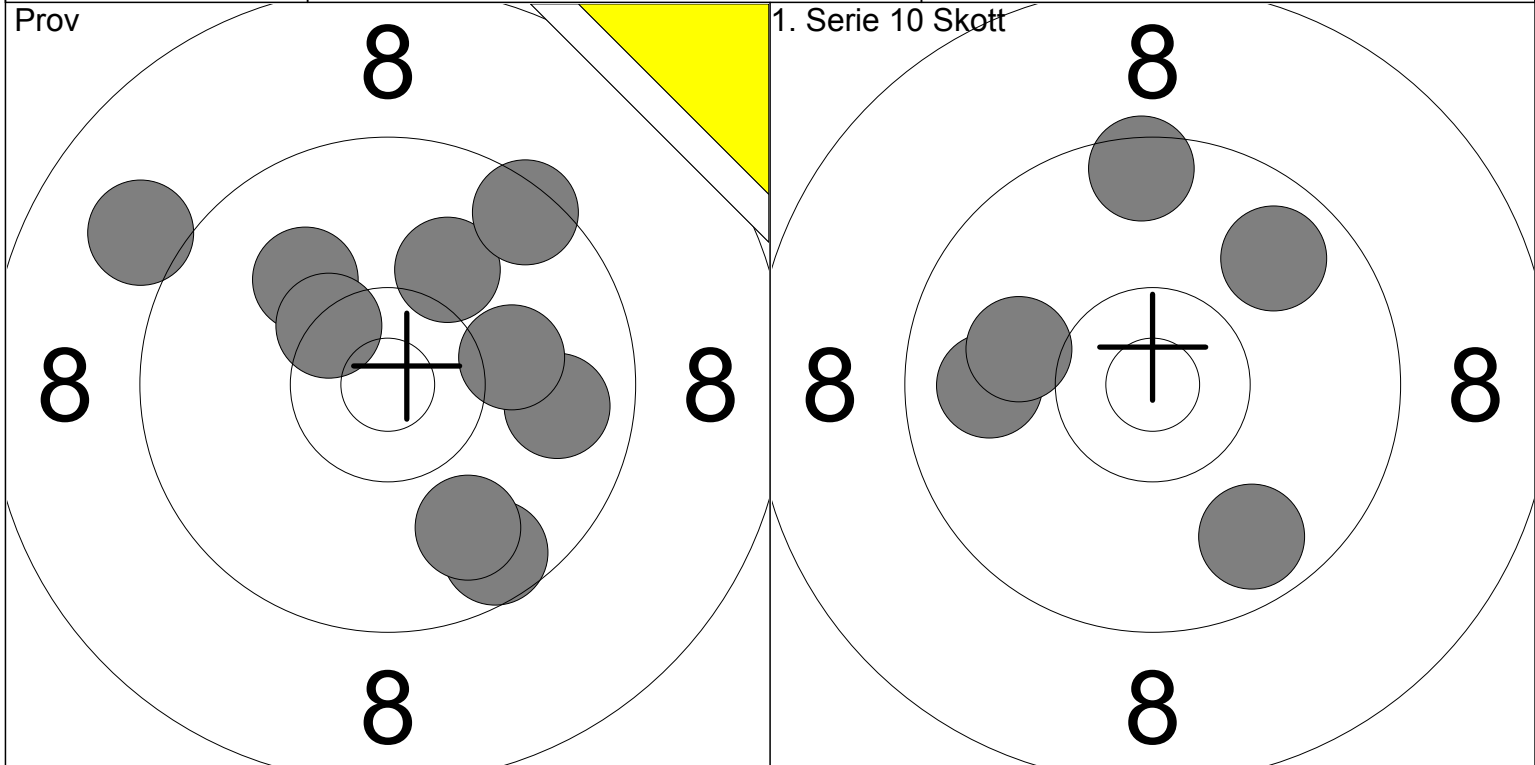

1: 9.6 ↙	6: 10.1 ↗	Serie 85	1: 9.9 ←	Serie 46
2: 9.9 ↘	7: 10.1 →		2: 9.8 ↗	
3: 9.8 →	8: 9.5 ↗	Total 191	3: 9.5 ↑	Total 237
4: 10.1 ↗	9: 10.4x ↖		4: 10.0 ←	
5: 9.0 ↖			5: 9.7 ↘	

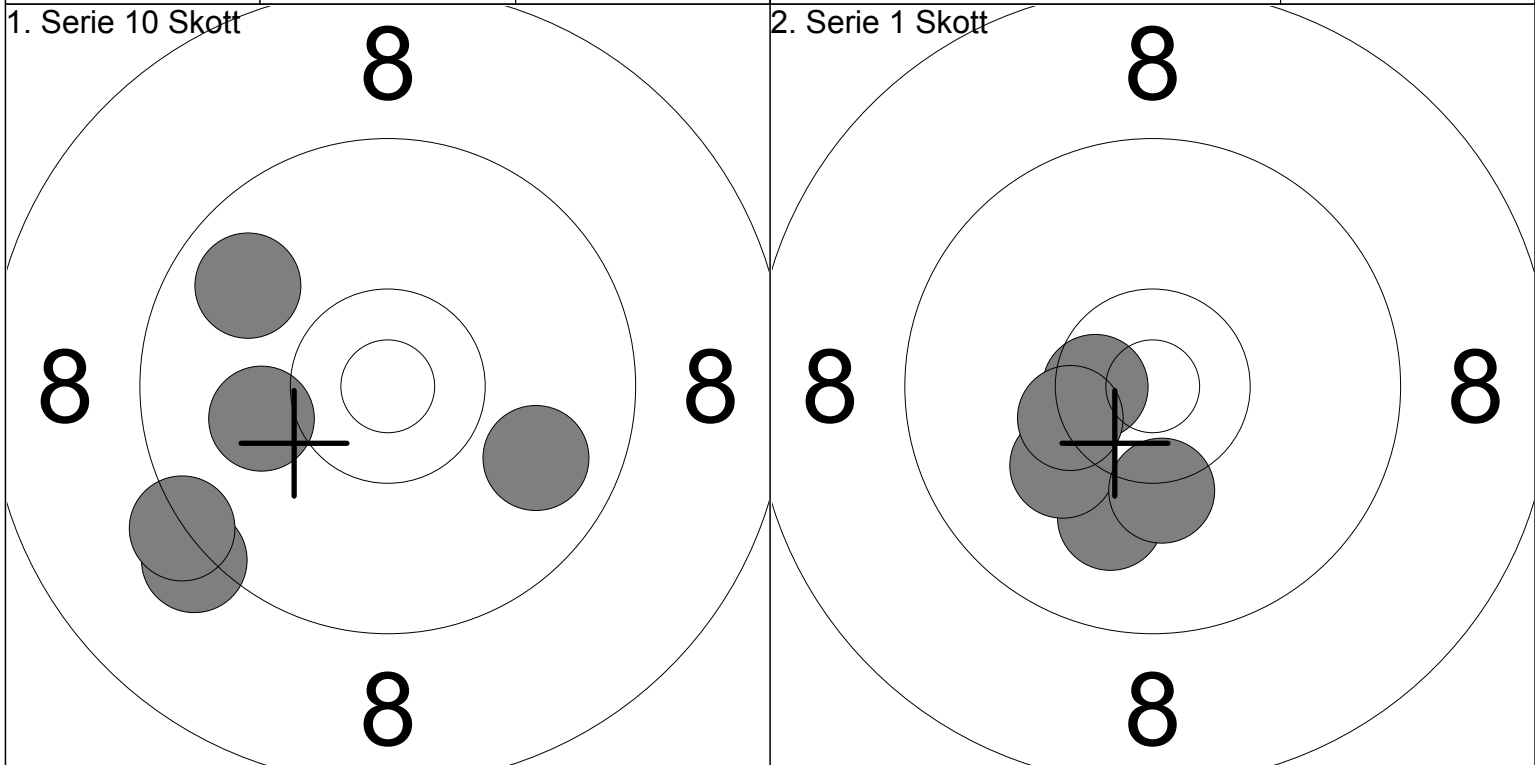

6: 9.2 ↙	Serie 46	1: 10.0 ↓	Serie 50
7: 9.8 ↖		2: 10.2 ↙	
8: 9.3 ↙	Total 283	3: 10.3 ↓	Total 333
9: 9.9 ↘		4: 10.6x ←	
10: 10.1 ←		5: 10.4x ←	

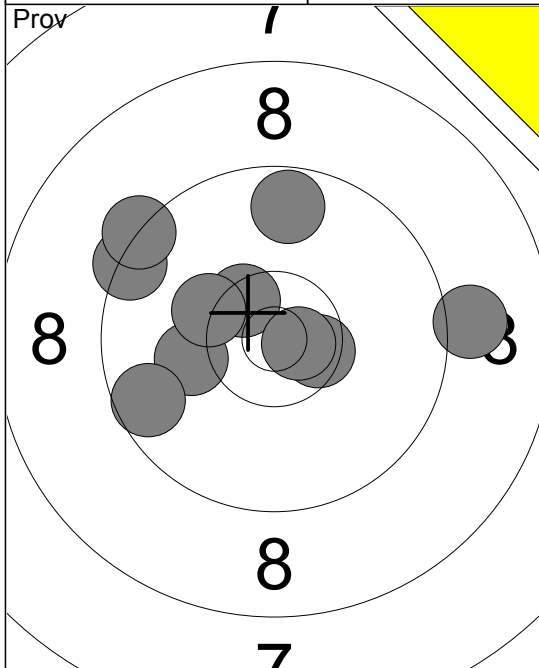

- 1: 10.5x ↘
- 2: 10.1 ←
- 3: 9.6 ↙
- 4: 10.5x →
- 5: 9.4 ↖
- 6: 9.1 →
- 7: 9.3 ↖
- 8: 10.7x →
- 9: 10.3 ↙
- 10: 9.7 ↑

Serie 95.0

Total 191.0

1. Serie 10 Skott

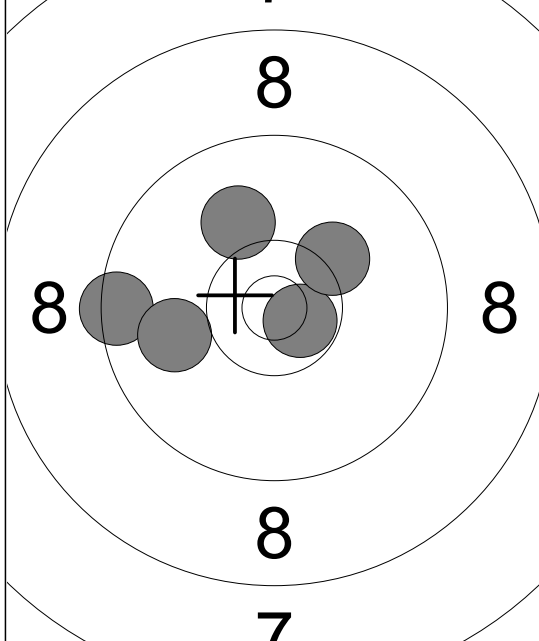

- 1: 10.7x →
- 2: 9.4 ←
- 3: 10.0 ←
- 4: 10.2 ↗
- 5: 10.1 ↖

Serie 49.0

Total 240.0

2. Serie 1 Skott

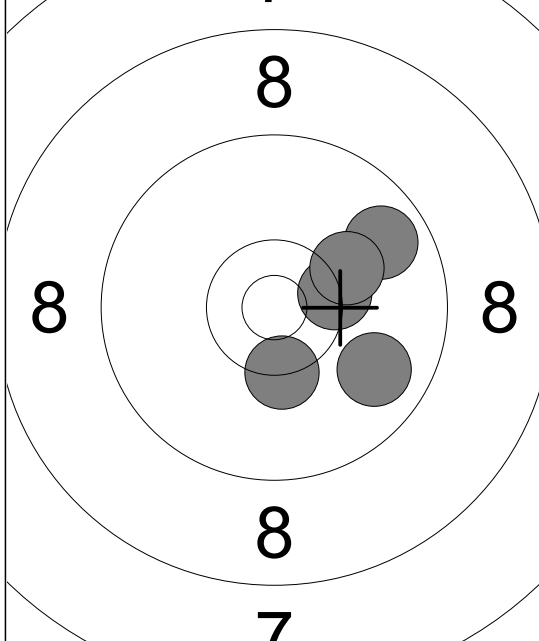

- 1: 10.3x ↓
- 2: 10.4x →
- 3: 9.8 ↘
- 4: 9.8 ↗
- 5: 10.2 ↗

Serie 48.0

Total 335.0

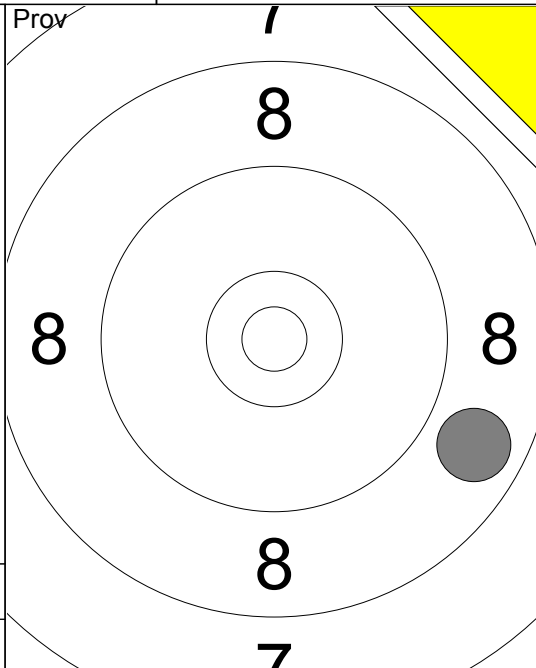

11: 8.8 ↘

Serie 8.0

Total 191.0

1. Serie 10 Skott

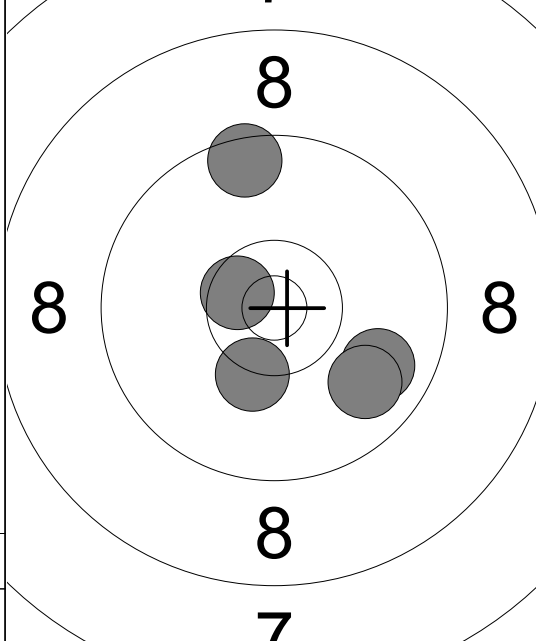

- 6: 9.5 ↑
- 7: 9.8 ↘
- 8: 9.8 ↘
- 9: 10.3 ↓
- 10: 10.6x ↘

Serie 47.0

Total 287.0

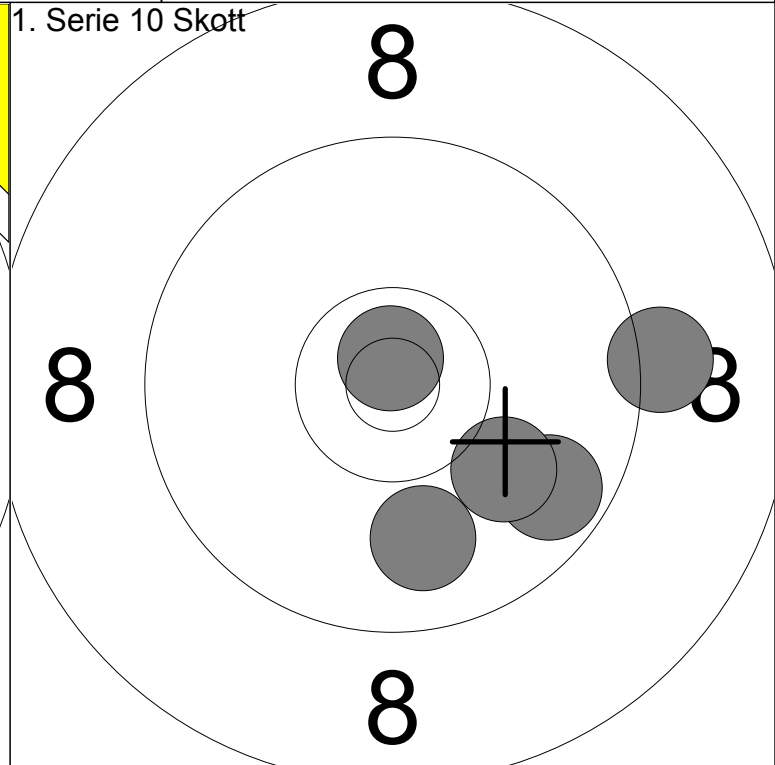
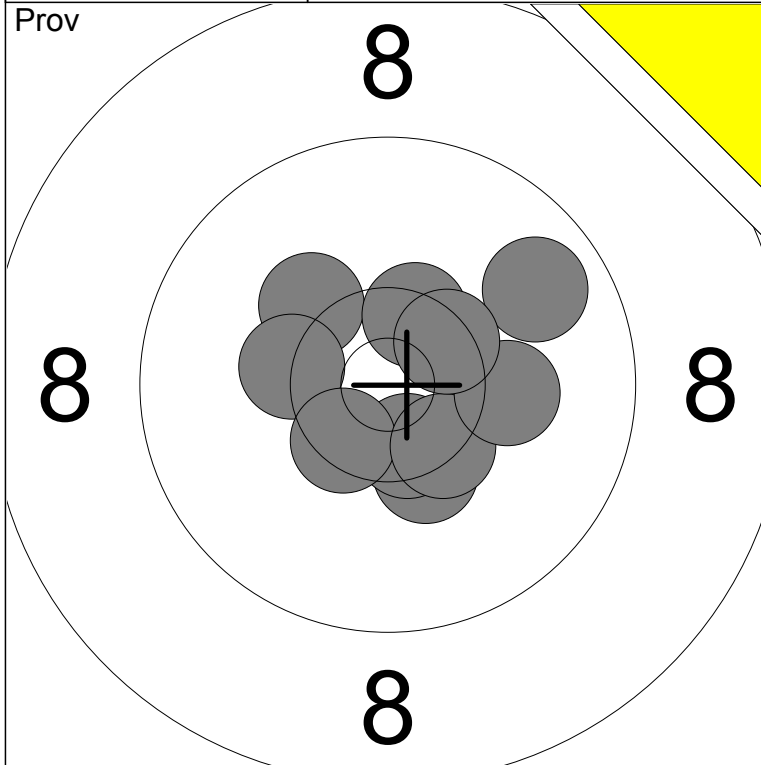

1: 10.3x ↘	6: 9.8 ↗	Serie	99
2: 10.5x ↘	7: 10.5x ↗		
3: 10.2 ↗	8: 10.4x ↘	Total	189
4: 10.3x ←	9: 10.2 →		
5: 10.5x ↙	10: 10.5x ↗		

1: 9.2 →	Serie	47
2: 10.8x ↑		
3: 9.7 ↘	Total	236
4: 9.9 ↘		
5: 10.0 ↘		

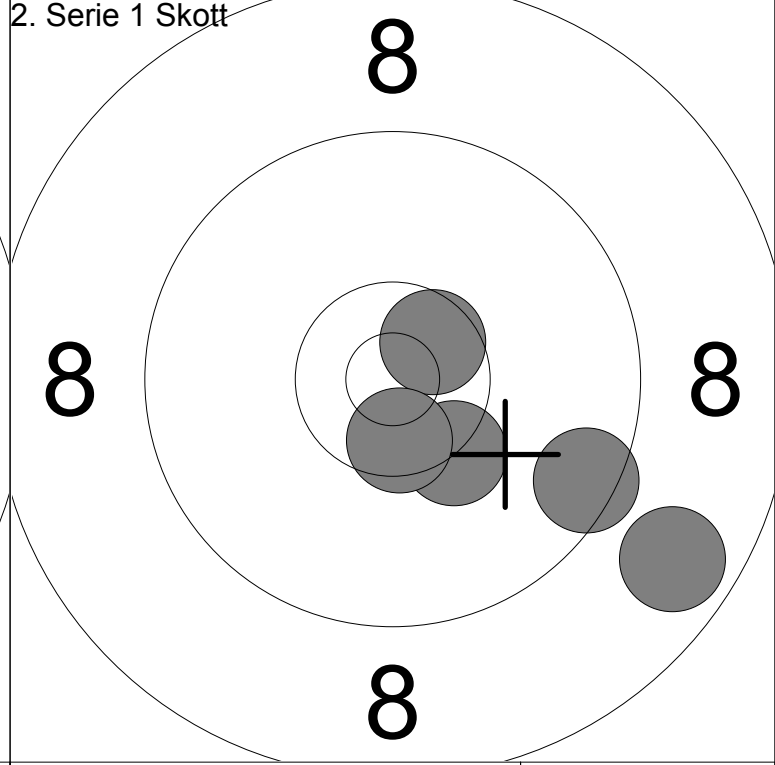
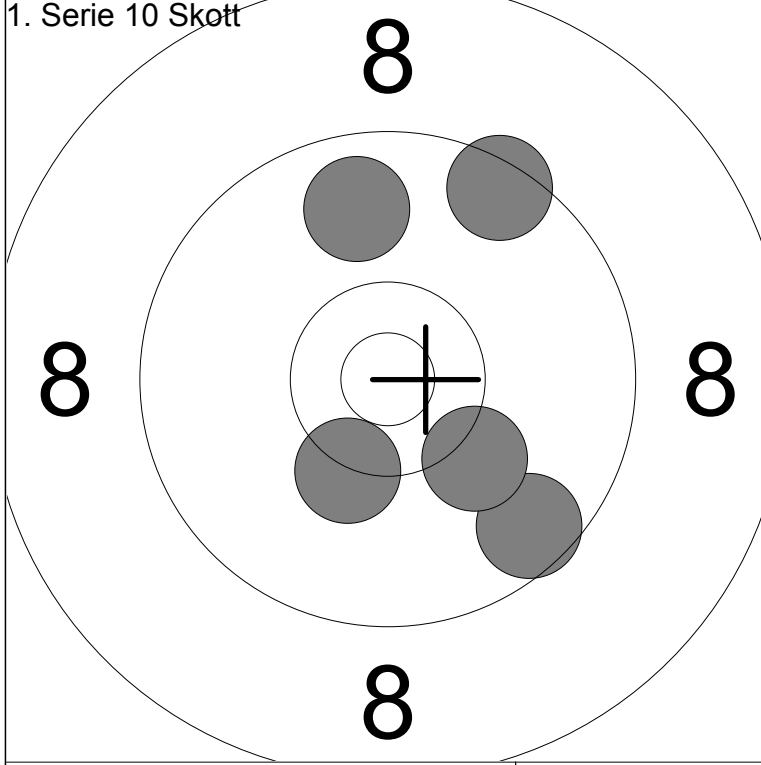

6: 10.3 ↘	Serie	47
7: 9.6 ↘		
8: 9.5 ↗	Total	283
9: 10.2 ↘		
10: 9.8 ↑		

1: 8.7 ↘	Serie	47
2: 10.6x ↗		
3: 10.3x ↘	Total	330
4: 9.5 ↘		
5: 10.5x ↘		

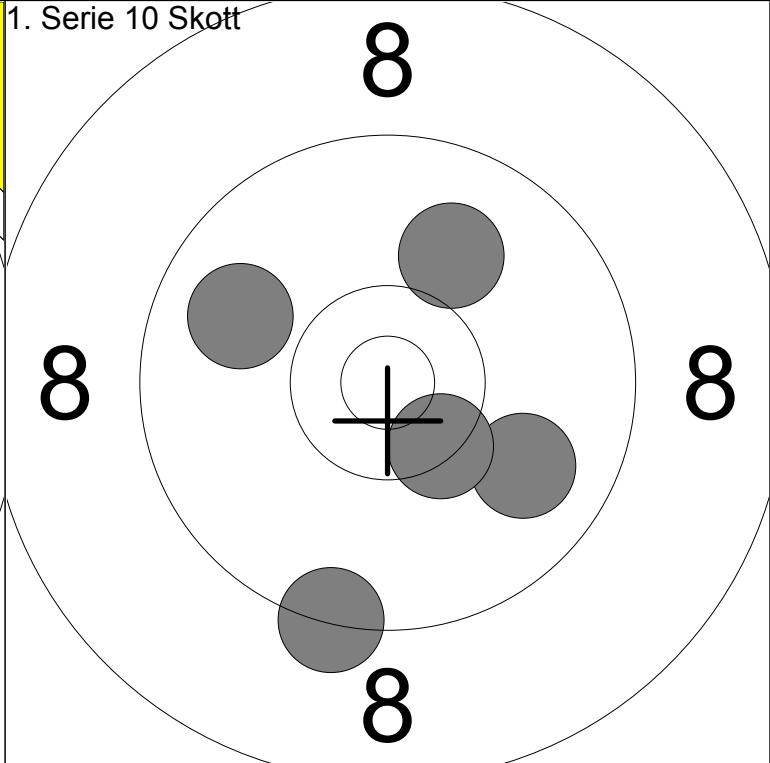
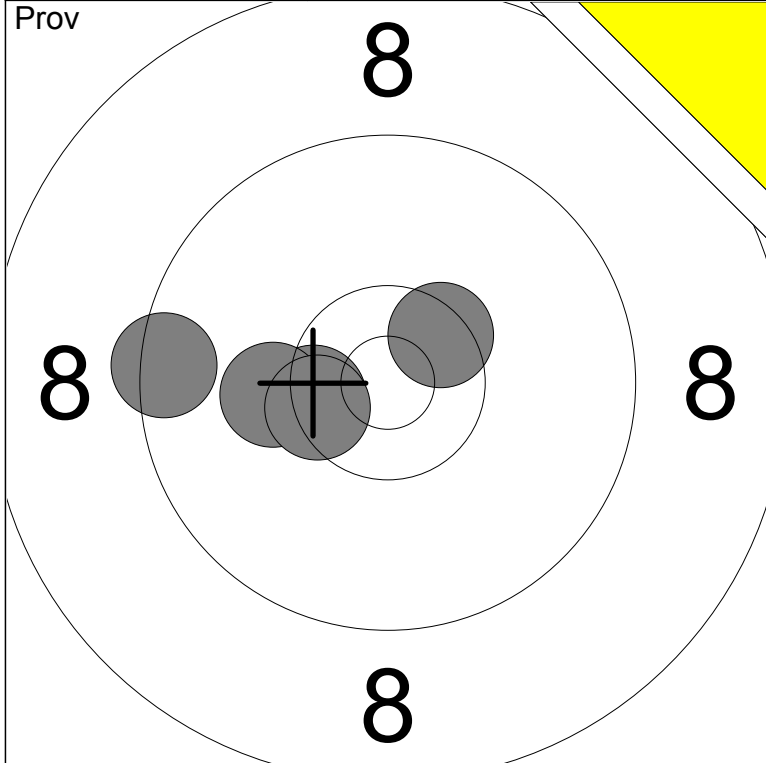

1:	10.4x	←
2:	9.5	←
3:	10.2	←
4:	10.5x	↗
5:	10.5x	←

Serie	49
Total	189

1:	9.9	↖
2:	9.9	↘
3:	10.0	↗
4:	9.3	↘
5:	10.4x	↘

Serie	47
Total	236

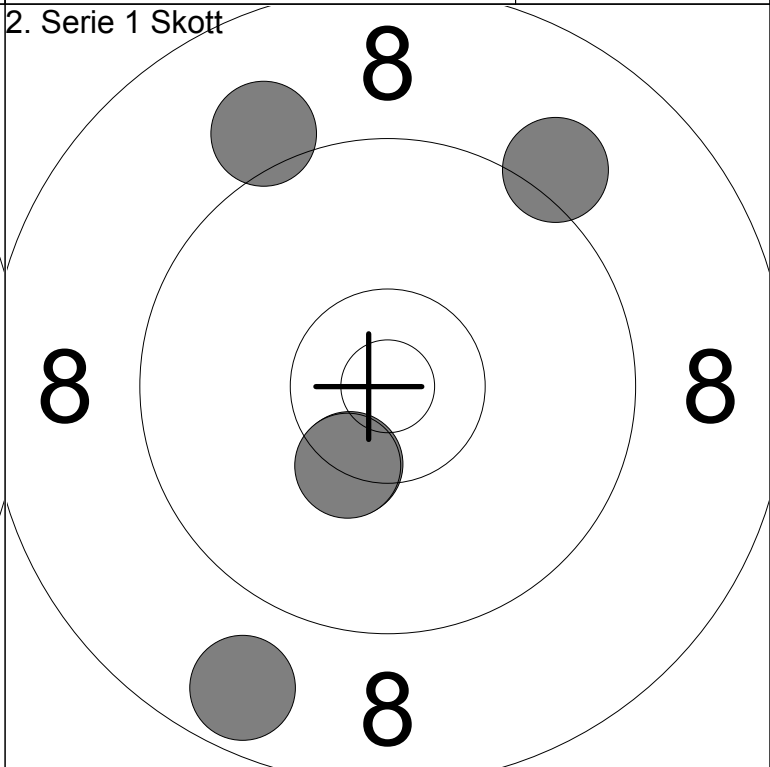
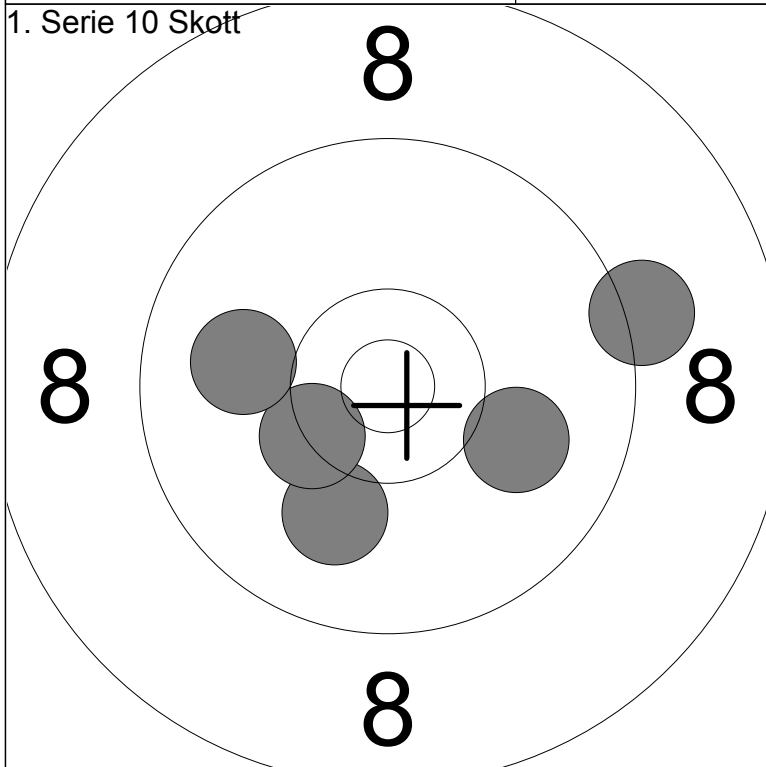

6:	10.0	↘
7:	10.0	→
8:	10.3x	↖
9:	10.0	←
10:	9.2	→

Serie	49
Total	285

1:	9.1	↗
2:	9.1	↖
3:	10.4x	↘
4:	8.7	↘
5:	10.4x	↘

Serie	46
Total	331

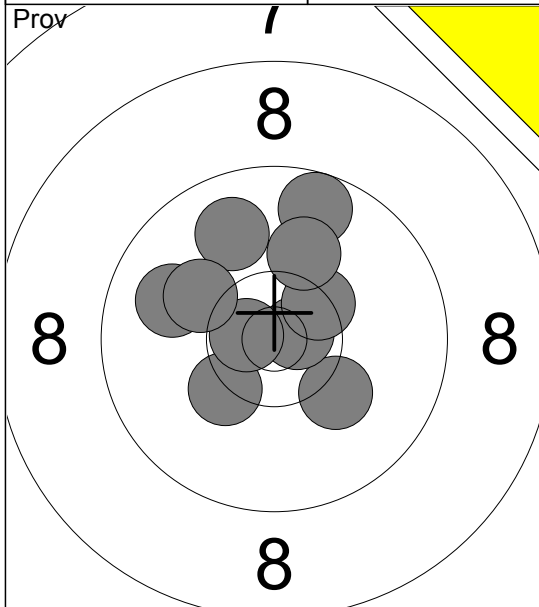

- 1: 10.2 ↘
- 2: 10.7x ➤
- 3: 10.3 ↙
- 4: 9.9 ←
- 5: 9.7 ↑
- 6: 10.4x ➤
- 7: 9.9 ↑
- 8: 10.7x ←
- 9: 10.1 ↙
- 10: 10.1 ↑

Serie 97.0

Total 188.0

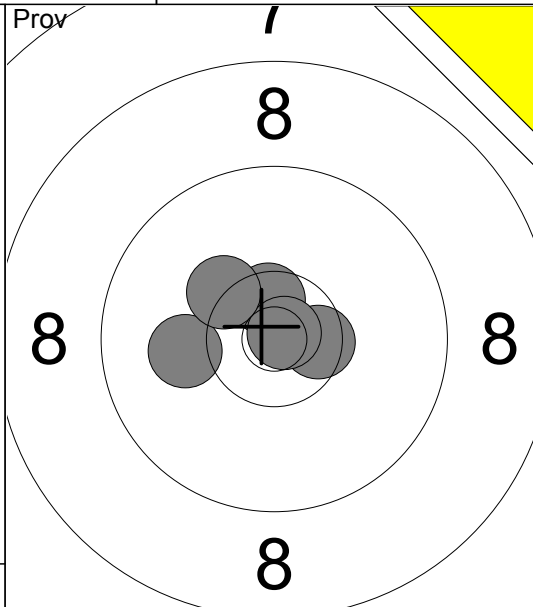

- 11: 10.6x ↗
- 12: 10.1 ←
- 13: 10.5x ➤
- 14: 10.8x ➤
- 15: 10.3x ↘

Serie 50.0

Total 188.0

1. Serie 10 Skott

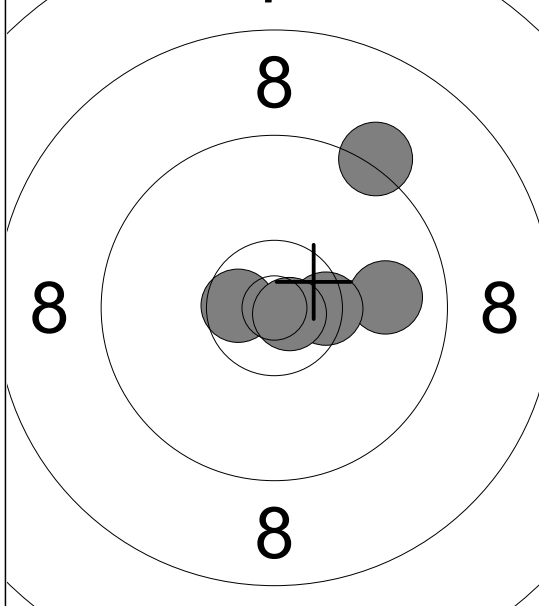

- 1: 9.9 ➔
- 2: 9.2 ↗
- 3: 10.5x ➤
- 4: 10.6x ←
- 5: 10.8x ➤

Serie 48.0

Total 236.0

1. Serie 10 Skott

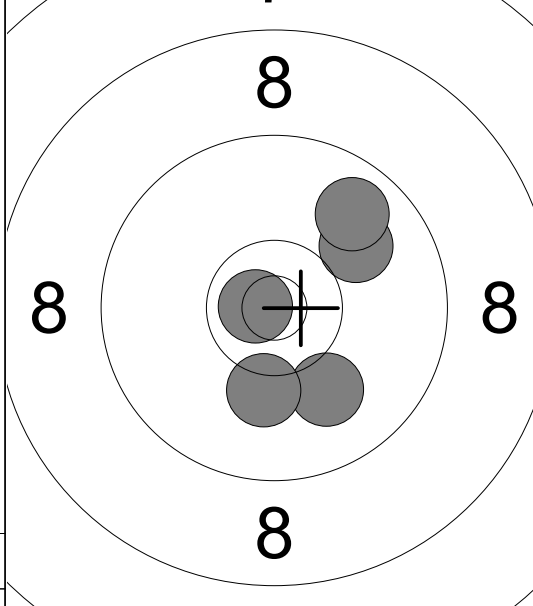

- 6: 10.8x ←
- 7: 10.0 ↗
- 8: 10.0 ↘
- 9: 10.2 ↓
- 10: 9.8 ↗

Serie 49.0

Total 285.0

2. Serie 1 Skott

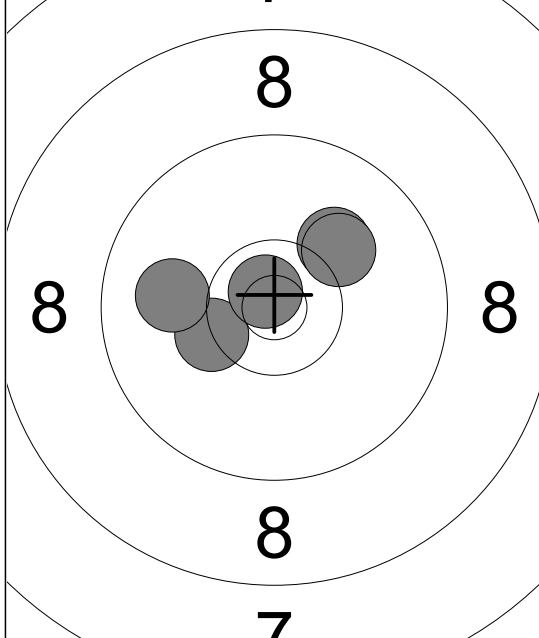

- 1: 10.3x ←
- 2: 10.1 ↗
- 3: 10.8x ↘
- 4: 10.1 ↗
- 5: 10.0 ←

Serie 50.0

Total 335.0

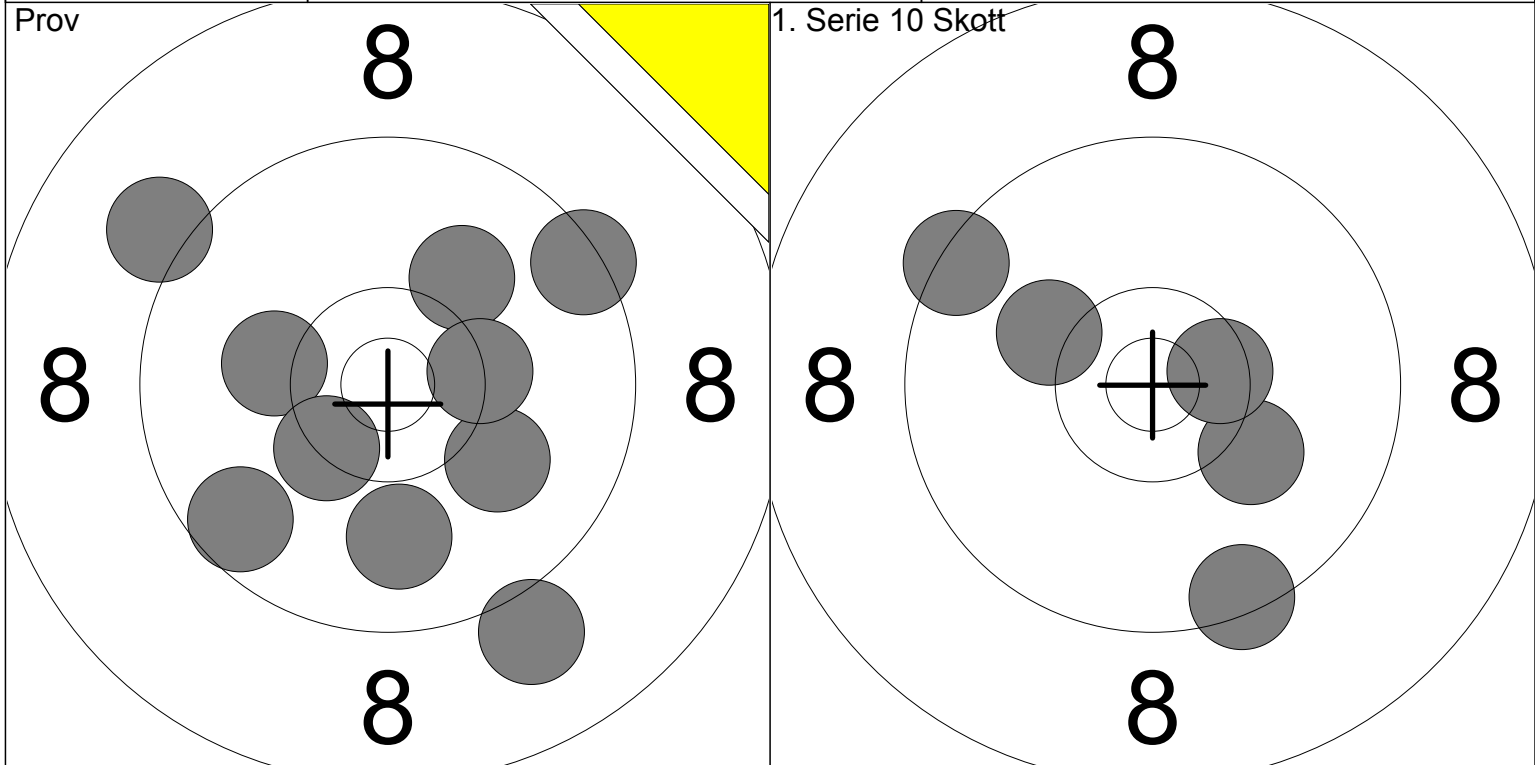

1: 9.1 ↗	6: 10.1 ↗	Serie	95	1: 10.2 ↘	Serie	48
2: 10.1 ↘	7: 9.4 ↗		Total	188		2: 10.5x →
3: 10.2 ←	8: 10.4x ↘				3: 9.4 ↘	
4: 9.6 ↘	9: 9.9 ↓			4: 9.4 ↗		
5: 9.0 ↘	10: 10.3x →			5: 10.2 ↗		

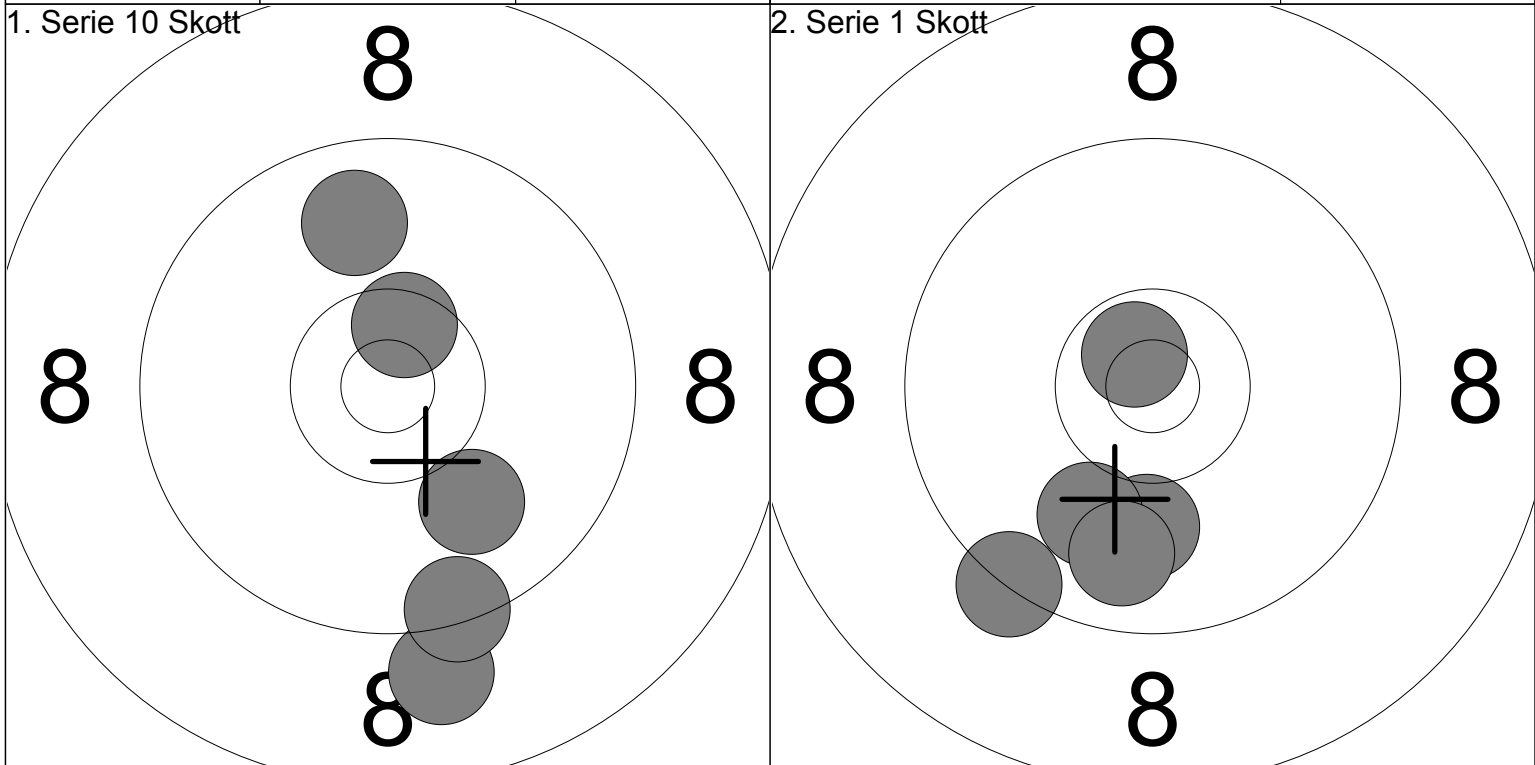

6: 10.5x ↑	Serie	47	1: 10.0 ↓	Serie	48
7: 9.0 ↘		Total	283		2: 10.7x ↗
8: 10.0 ↘				3: 9.3 ↘	
9: 9.4 ↘			4: 10.0 ↘		
10: 9.8 ↑			5: 9.8 ↓		

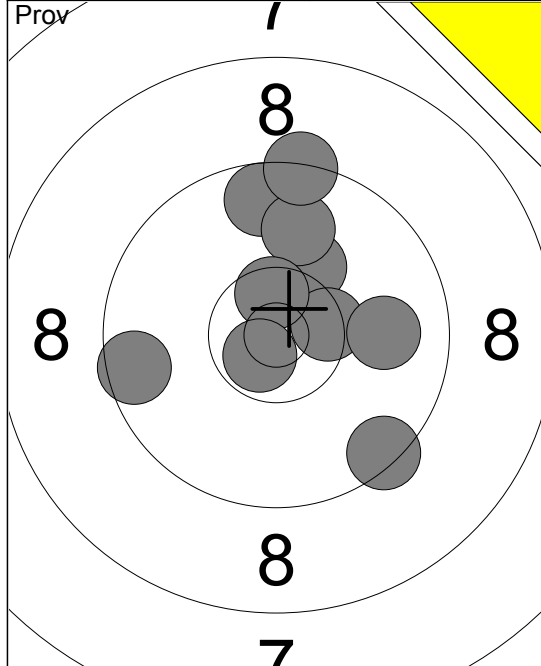

1:	9.6	↑
2:	10.2	↗
3:	9.4	↘
4:	9.9	↑
5:	10.4	➔
6:	9.9	➔
7:	9.3	↑
8:	10.6	↗
9:	9.6	←
10:	10.7	↘
Serie		94.0
Total		190.0

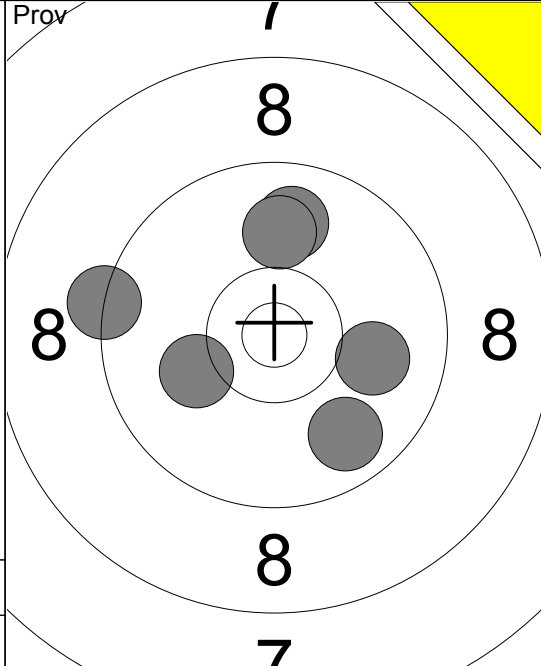

11:	9.9	↑
12:	10.0	↑
13:	9.3	←
14:	10.1	↙
15:	9.8	↘
16:	10.0	➔
Serie		57.0
Total		190.0

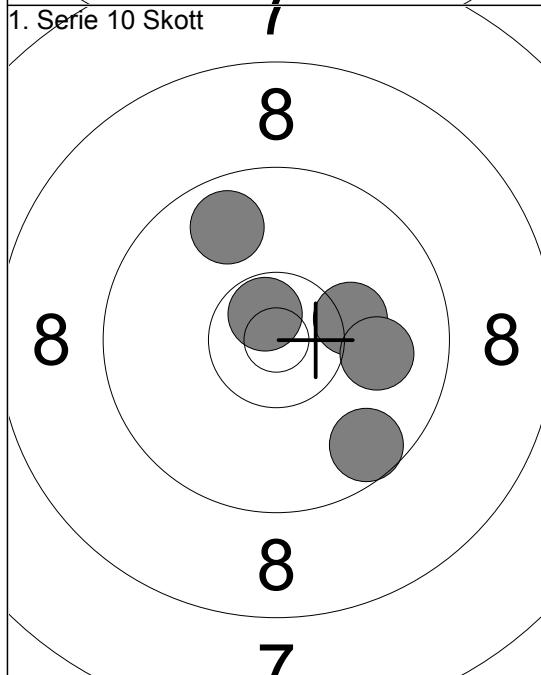

1:	9.6	↘
2:	9.8	↑
3:	10.7	↗
4:	10.2	➔
5:	10.0	➔
Serie		48.0
Total		238.0

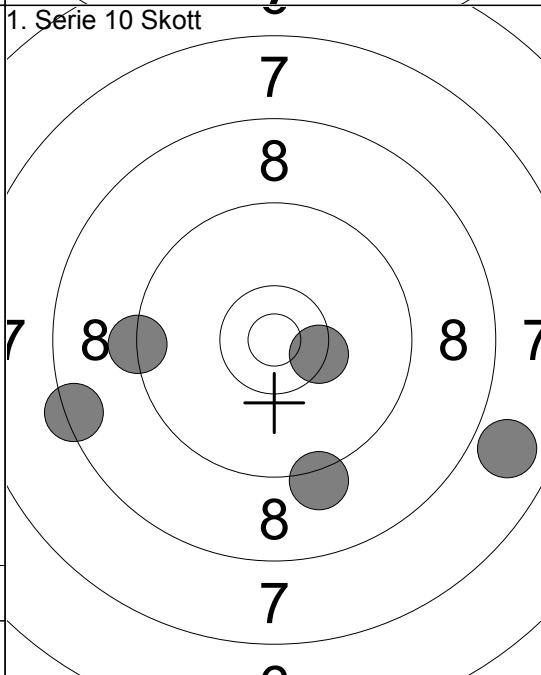

6:	9.3	←
7:	9.2	↘
8:	7.9	➔
9:	8.4	←
10:	10.4	➔
Serie		43.0
Total		281.0

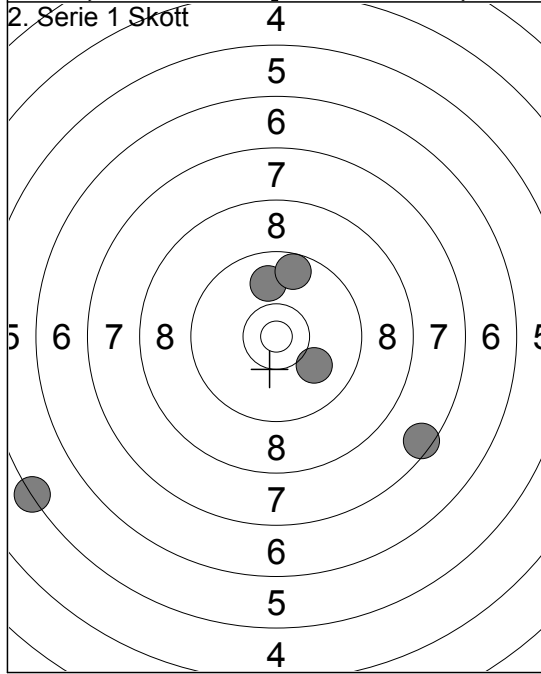

1:	5.3	↙
2:	9.9	↑
3:	10.0	↘
4:	9.6	↑
5:	7.5	↘
Serie		40.0
Total		321.0

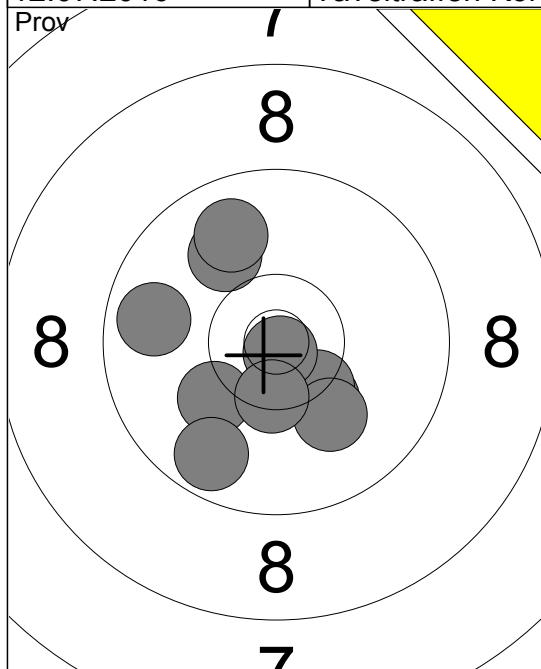

- 1: 10.3 ↘
- 2: 10.4x ↘
- 3: 10.2 ↙
- 4: 9.8 ←
- 5: 9.7 ↙
- 6: 10.8x ↘
- 7: 10.1 ↘
- 8: 10.0 ↗
- 9: 9.8 ↗
- 10: 10.4x ↘

Serie 97.0
Total 189.0

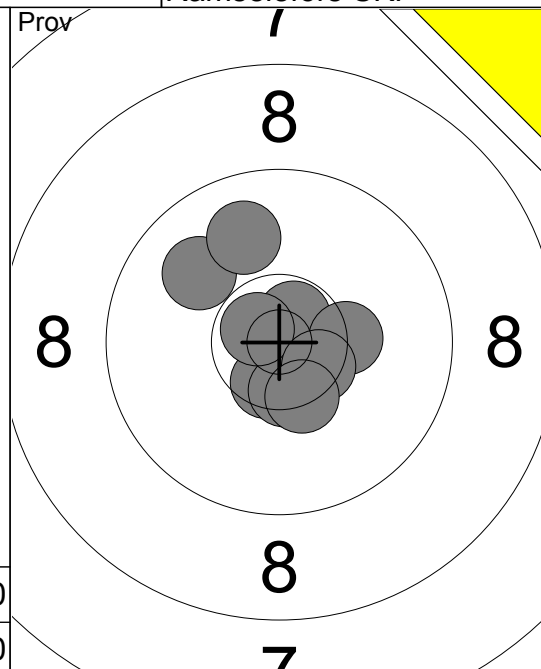

- 11: 10.6x ↘
- 12: 9.9 ↖
- 13: 10.7x ↗
- 14: 10.3x →
- 15: 10.5x ↘
- 16: 10.7x ↘
- 17: 10.5x ↘
- 18: 10.4x ↘
- 19: 9.9 ↗

Serie 88.0
Total 189.0

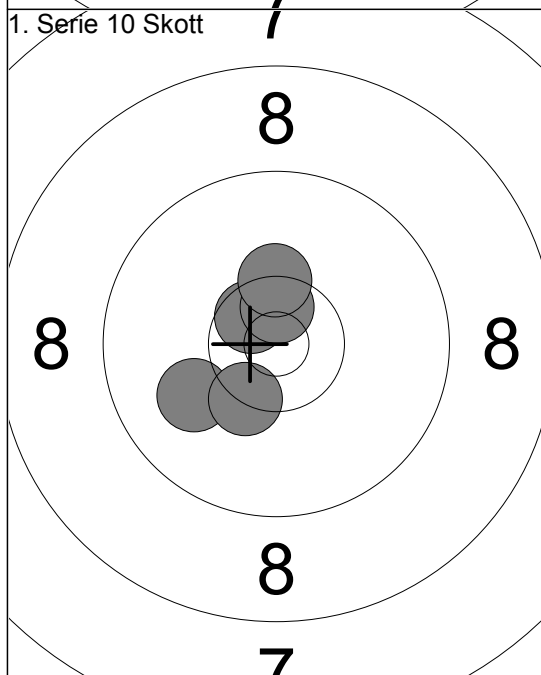

- 1: 10.6x ↘
- 2: 10.0 ↙
- 3: 10.6x ↗
- 4: 10.3x ↗
- 5: 10.3x ↘

Serie 50.0
Total 239.0

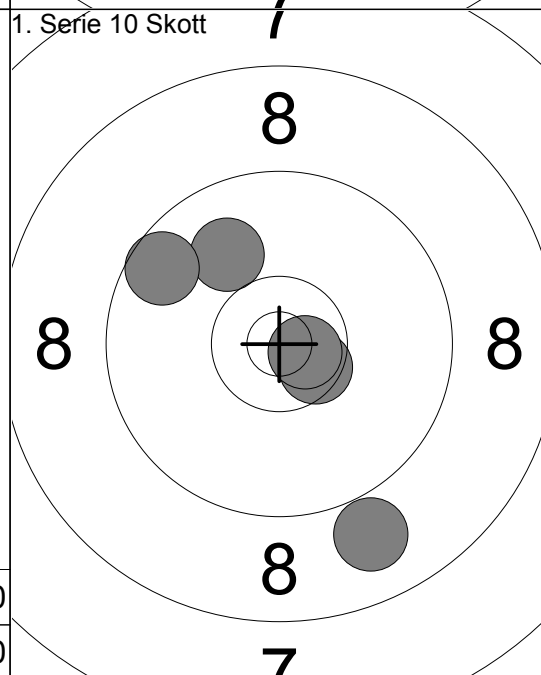

- 6: 10.5x ↘
- 7: 10.7x →
- 8: 8.9 ↙
- 9: 10.0 ↗
- 10: 9.6 ↖

Serie 47.0
Total 286.0

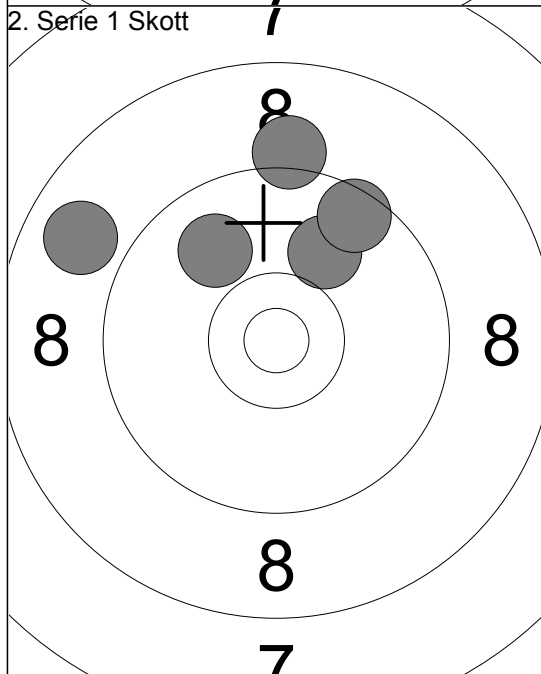

- 1: 8.8 ↖
- 2: 9.9 ↗
- 3: 10.0 ↗
- 4: 9.6 ↗
- 5: 9.1 ↗

Serie 45.0
Total 331.0

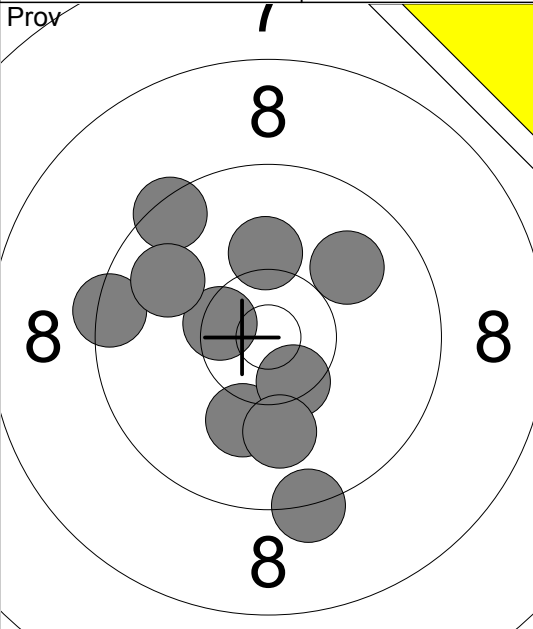
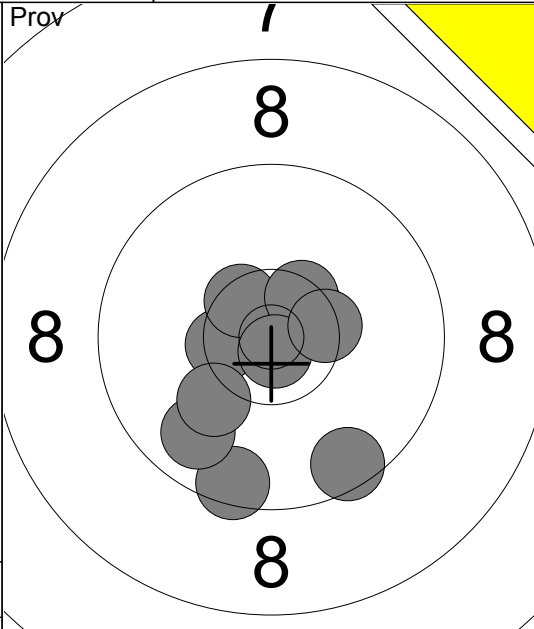
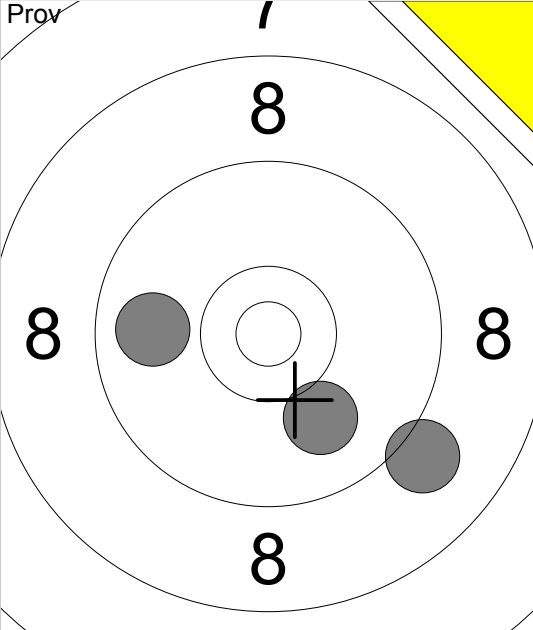
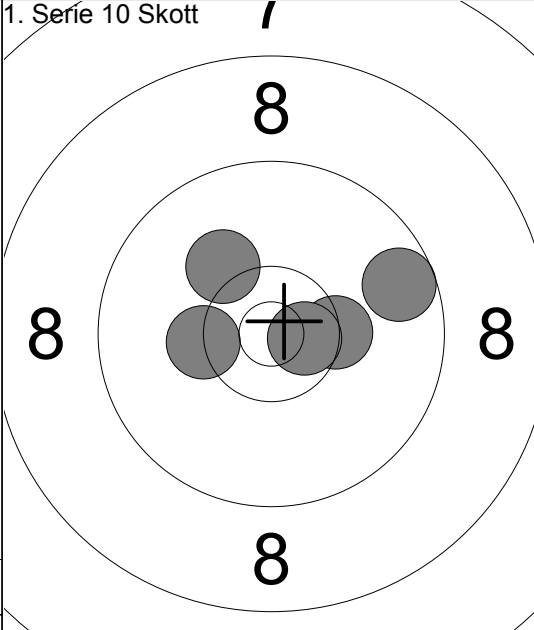
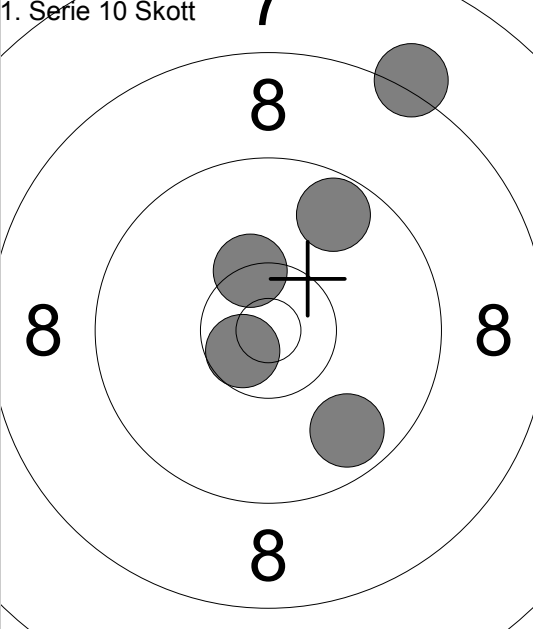
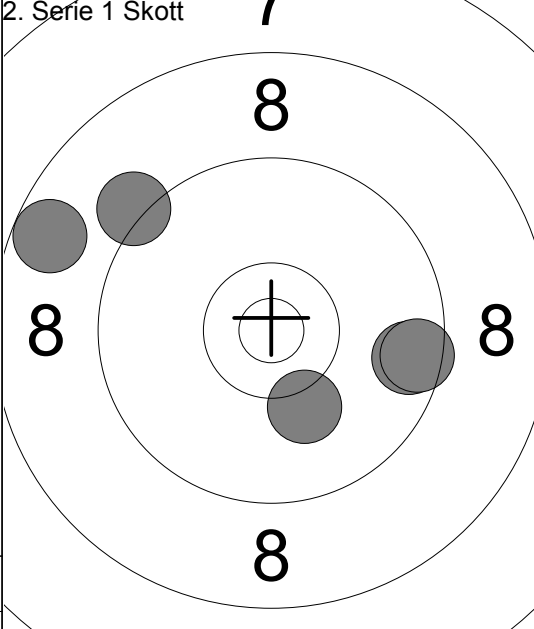
Skjutlag	Tavla	Hilde Karlsson					
7	3			50m	Ramselefors		
12.07.2016		Tavelträffen Korthåll 2016		Ramselefors SKF			
Prov	7		1: 9.4 ↗ 2: 9.4 ← 3: 10.1 ↑ 4: 10.5x ↘ 5: 10.1 ↓ 6: 10.0 ↗ 7: 10.5x ↓ 8: 9.9 ← 9: 10.0 ↓ 10: 9.3 ↓	Prov	7		11: 10.5x ↘ 12: 10.5x ↘ 13: 10.5x ↗ 14: 10.5x ↗ 15: 9.5 ↓ 16: 10.8x ↓ 17: 9.8 ↓ 18: 10.4x → 19: 9.5 ↓ 20: 10.1 ↘
		Serie 96.0				Serie 97.0	
		Total 189.0				Total 189.0	
Prov	7		21: 9.1 ↓ 22: 10.0 ↓ 23: 9.8 ←	1. Serie 10 Skott	7		1: 10.3x → 2: 9.6 → 3: 10.6x → 4: 10.2 ↖ 5: 10.3x ↘
		Serie 28.0				Serie 49.0	
		Total 189.0				Total 238.0	
1. Serie 10 Skott	7		6: 9.7 ↓ 7: 8.2 ↗ 8: 10.4x ↗ 9: 9.7 ↗ 10: 10.6x ↘	2. Serie 1 Skott	7		1: 8.7 ← 2: 9.6 → 3: 9.5 → 4: 9.2 ↖ 5: 10.2 ↓
		Serie 46.0				Serie 45.0	
		Total 284.0				Total 329.0	

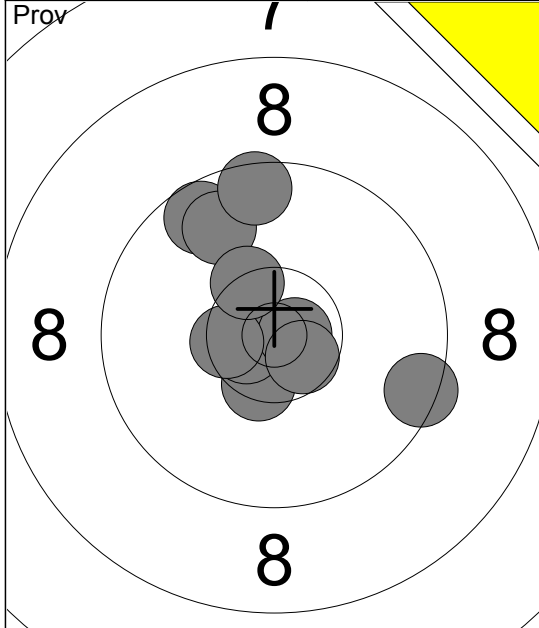

1:	10.5x ↘
2:	10.7x ↘
3:	9.6 ↗
4:	9.8 ↗
5:	10.8x ➤
6:	10.5x ←
7:	9.5 ↗
8:	10.6x ↘
9:	9.5 ➤
10:	10.4x ↘
Serie	96.0
Total	189.0

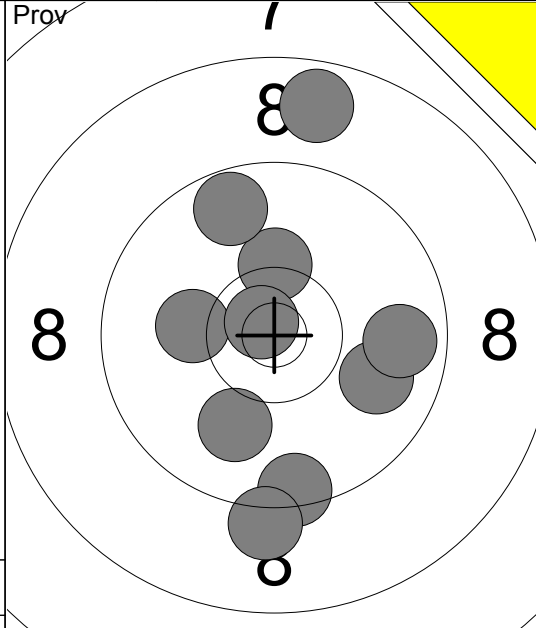

11:	9.5 ↓
12:	9.2 ↓
13:	8.7 ↗
14:	9.9 ➤
15:	10.0 ↘
16:	10.2 ←
17:	10.3 ↗
18:	10.8x ↘
19:	9.8 ➤
20:	9.7 ↗
Serie	93.0
Total	189.0

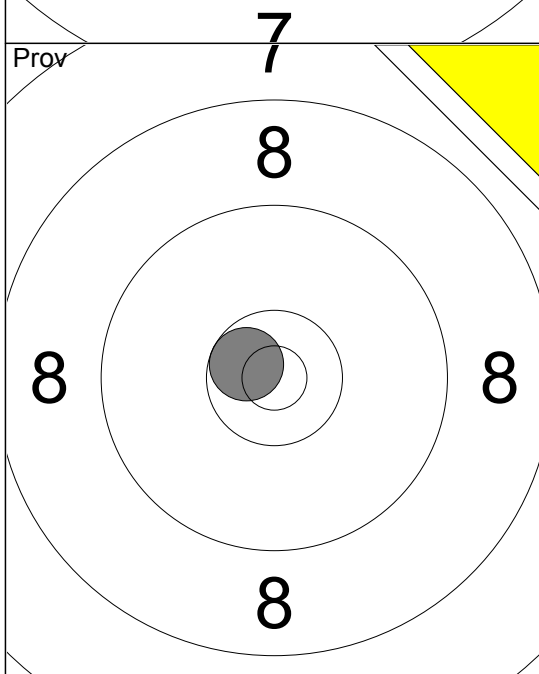

21:	10.7x ↘
Serie	10.0
Total	189.0

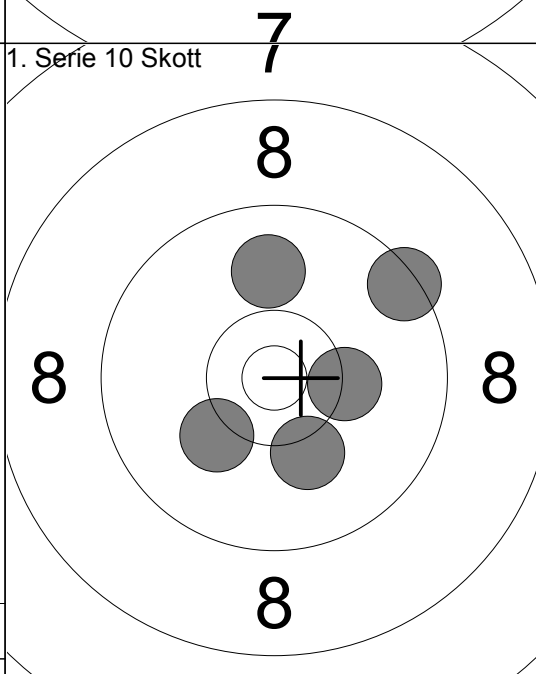

1:	9.9 ↗
2:	9.4 ↗
3:	10.3 ➤
4:	10.2 ↘
5:	10.2 ↘
Serie	48.0
Total	237.0

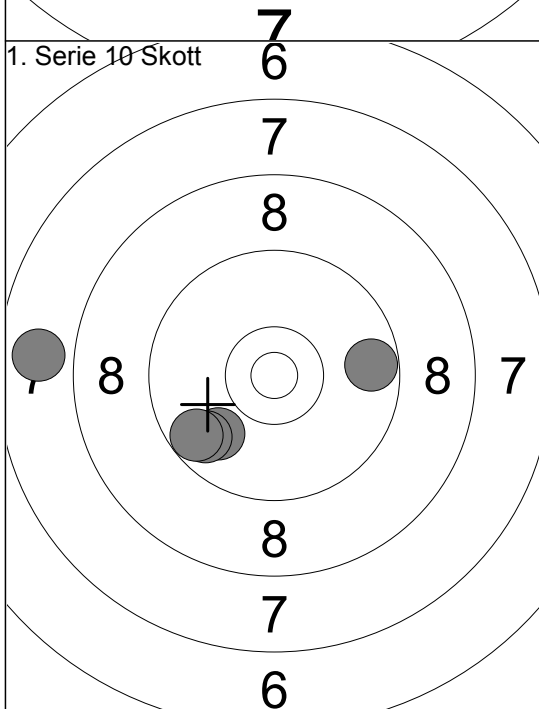

6:	9.7 ➤
7:	9.9 ↘
8:	9.7 ↘
9:	9.7 ↘
10:	7.8 ←
Serie	43.0
Total	280.0

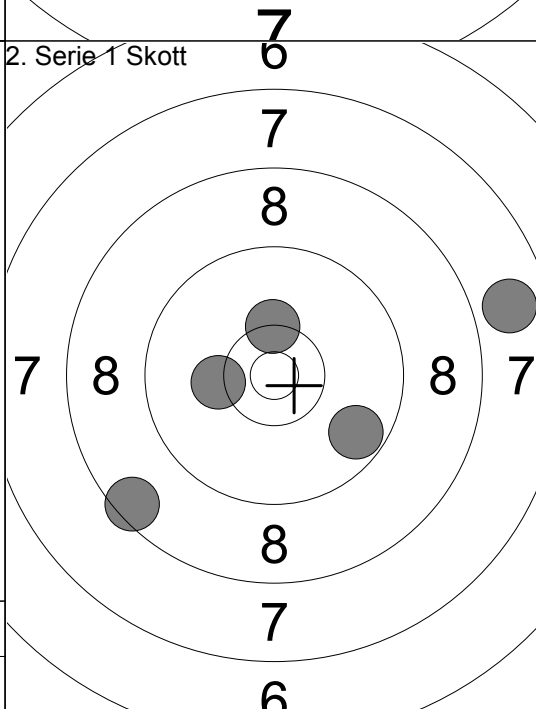

1:	7.8 ➤
2:	10.2 ←
3:	8.5 ↘
4:	10.3x ↗
5:	9.7 ➤
Serie	44.0
Total	324.0

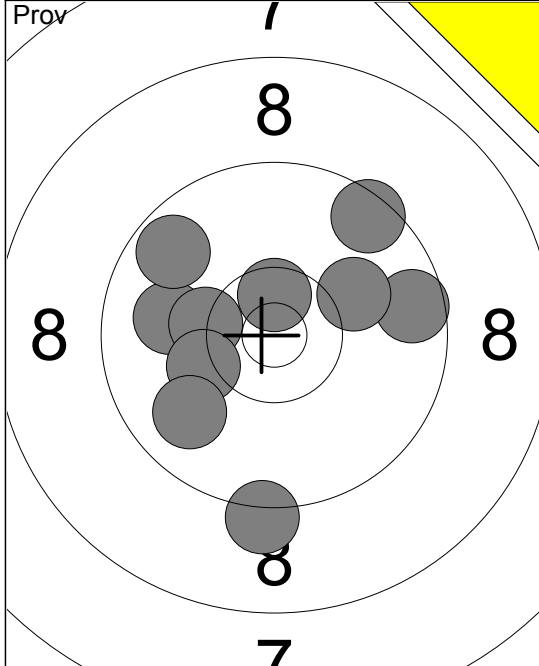

Prov

1:	9.6	→
2:	9.5	↗
3:	9.9	←
4:	10.3	←
5:	9.7	↖
6:	10.6x	↗
7:	10.2	←
8:	9.2	↓
9:	10.1	↗
10:	9.9	↙
Serie	94.0	
Total	188.0	

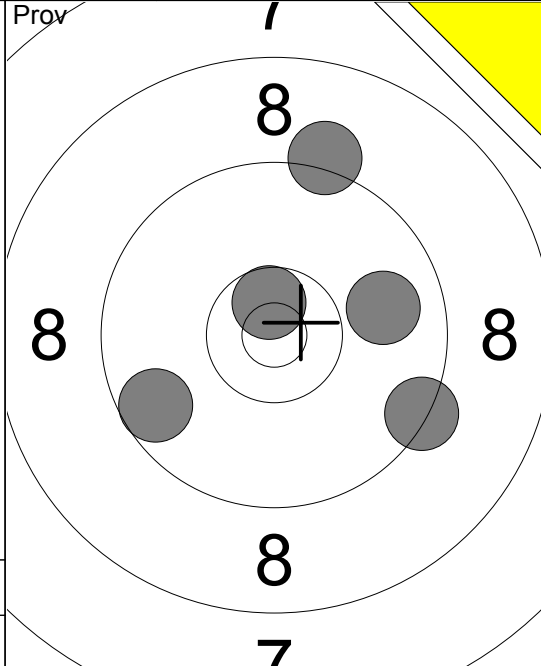

Prov

11:	9.6	↙
12:	9.2	↗
13:	10.6x	↗
14:	9.4	↘
15:	9.9	→
Serie	46.0	
Total	188.0	

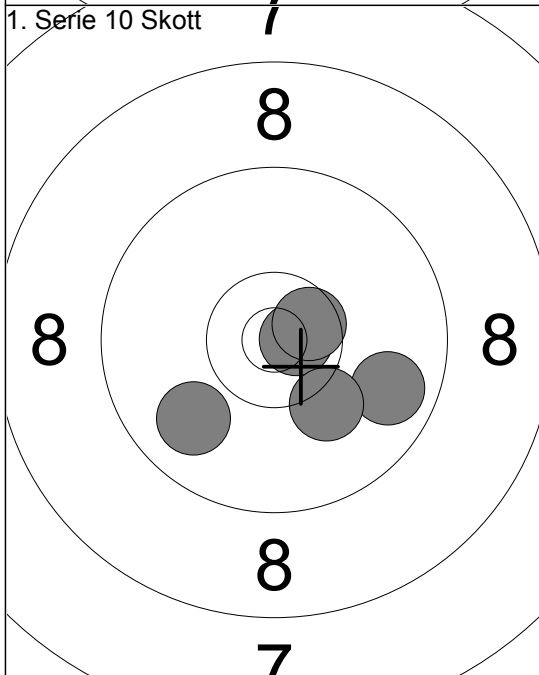

1. Serie 10 Skott

1:	9.8	→
2:	10.7x	→
3:	10.2	↘
4:	10.6x	↗
5:	9.9	↙
Serie	48.0	
Total	236.0	

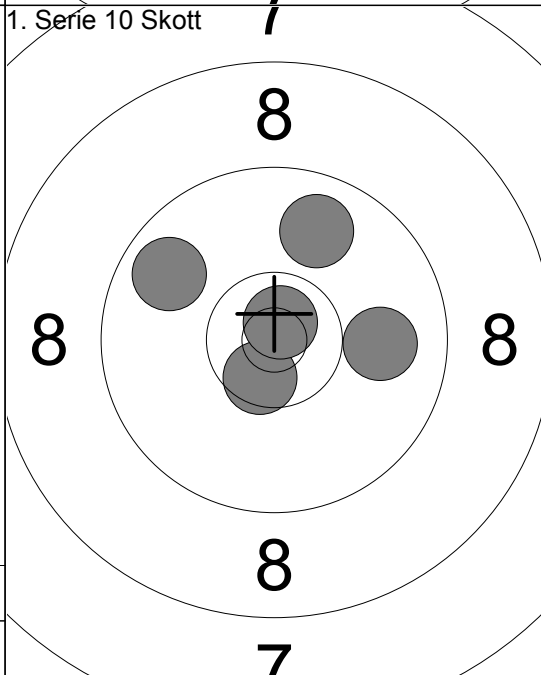

1. Serie 10 Skott

6:	10.6x	↘
7:	9.8	↖
8:	10.8x	↗
9:	9.9	→
10:	9.8	↗
Serie	47.0	
Total	283.0	

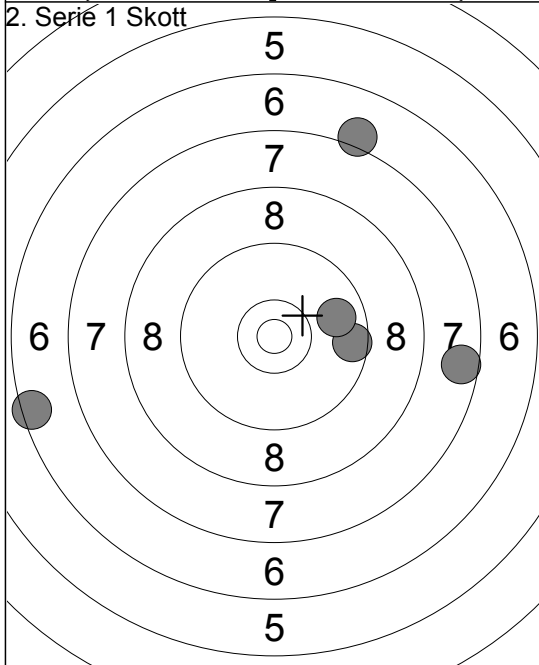

2. Serie 1 Skott

1:	7.1	↗
2:	6.5	←
3:	7.6	→
4:	9.6	→
5:	9.8	→
Serie	38.0	
Total	321.0	

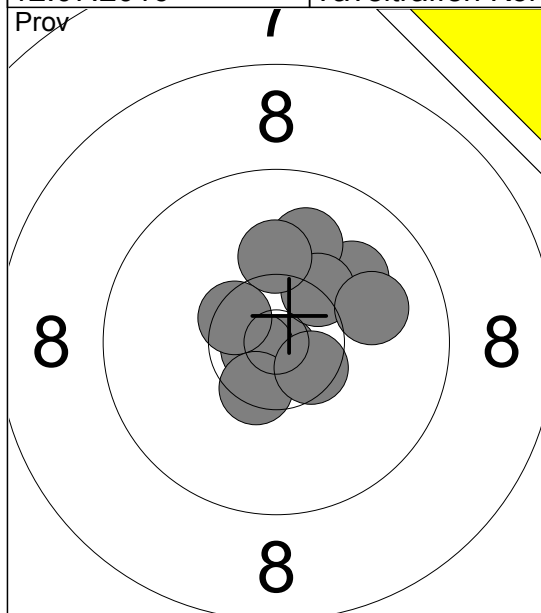

1:	10.8x
2:	10.0
3:	10.0
4:	10.3x
5:	10.1
6:	10.8x
7:	10.0
8:	10.5x
9:	10.5x
10:	10.5x
Serie	100.0
Total	188.0

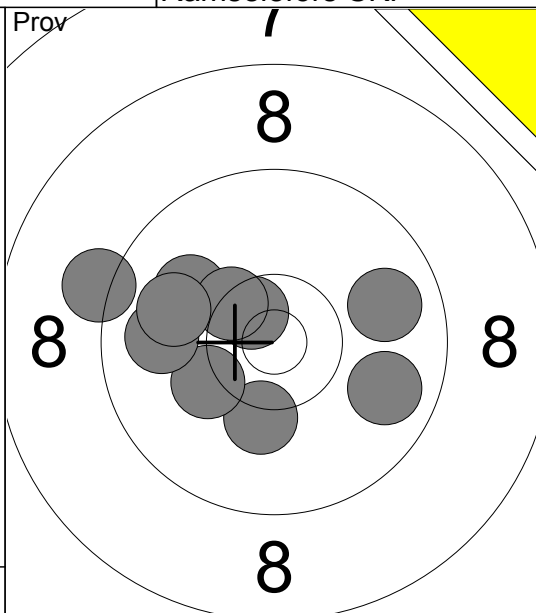

11:	10.2
12:	10.2
13:	10.6x
14:	9.9
15:	10.0
16:	9.2
17:	10.4x
18:	9.8
19:	9.8
20:	9.9
Serie	95.0
Total	188.0

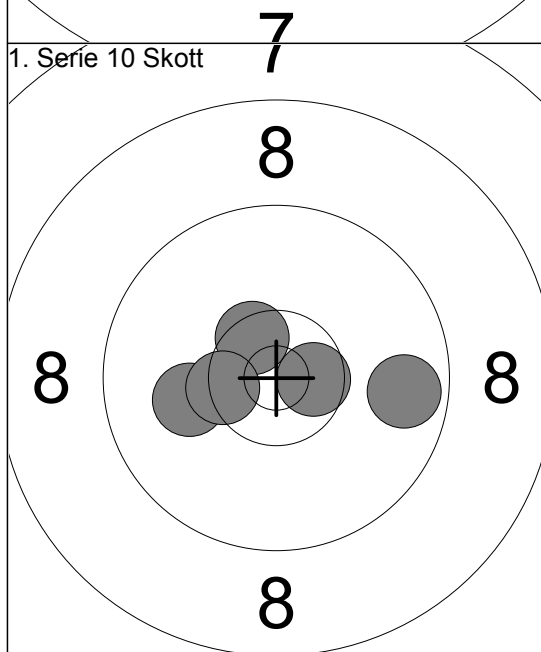

1:	9.7
2:	10.6x
3:	10.1
4:	10.5x
5:	10.4x
Serie	49.0
Total	237.0

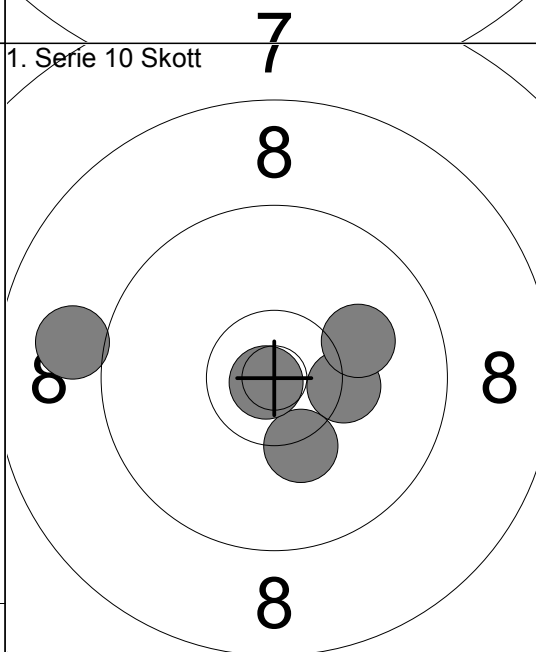

6:	9.0
7:	10.3
8:	10.1
9:	10.3
10:	10.9x
Serie	49.0
Total	286.0

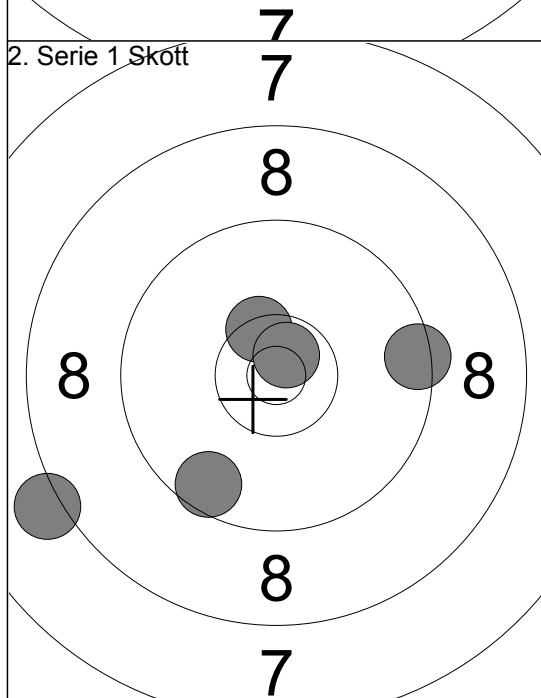

1:	8.2
2:	10.4x
3:	10.7x
4:	9.4
5:	9.6
Serie	46.0
Total	332.0

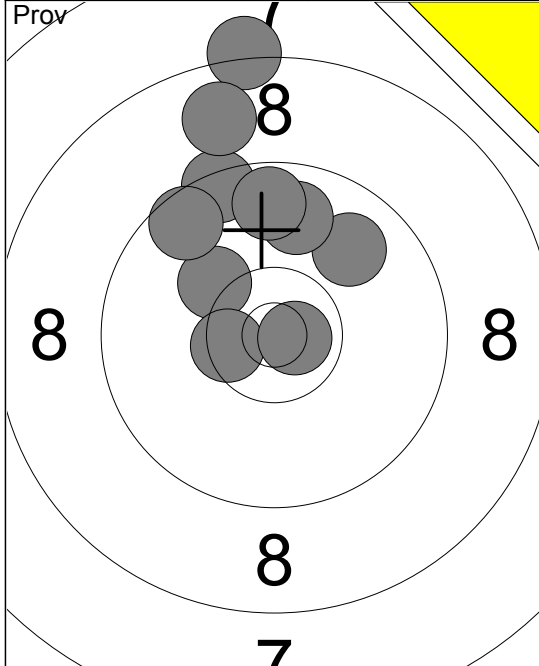

1:	9.9 ↗
2:	9.4 ↗
3:	8.2 ↑
4:	9.8 ↑
5:	10.2 ↖
6:	8.8 ↑
7:	10.5 ✕
8:	9.7 ↑
9:	9.6 ↖
10:	10.8 ✕➔
Serie	91.0
Total	187.0

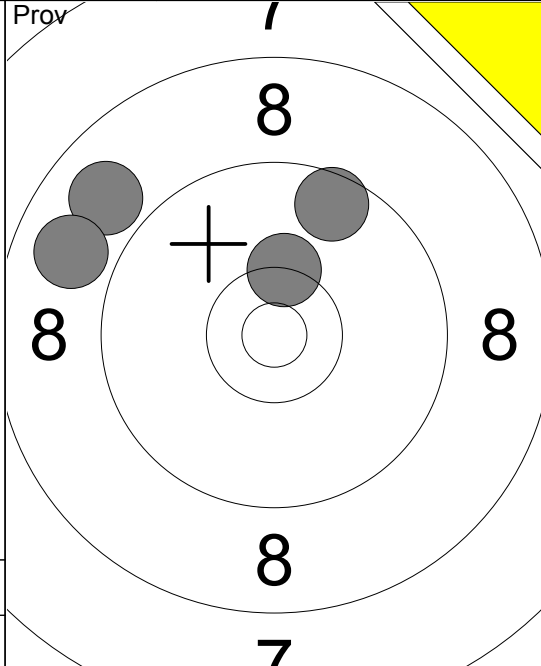

11:	8.9 ↖
12:	9.6 ↗
13:	10.3 ✕↗
14:	8.9 ↖
Serie	35.0
Total	187.0

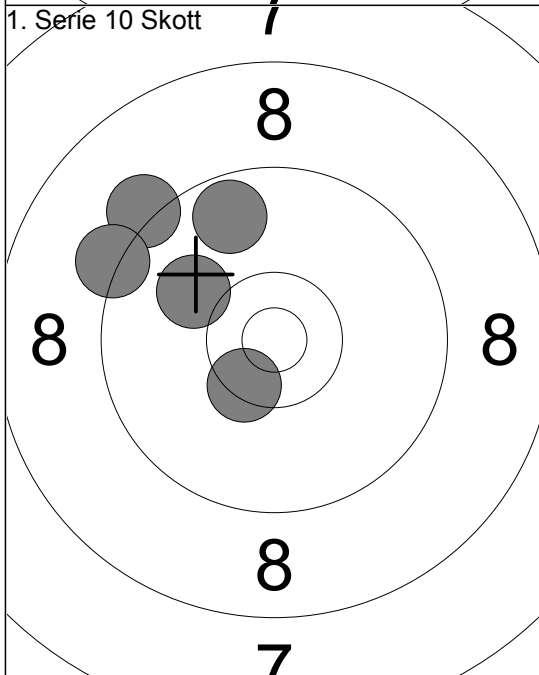

1:	9.7 ↑
2:	10.0 ↖
3:	10.4 ✕↖
4:	9.2 ↖
5:	9.2 ↖
Serie	47.0
Total	234.0

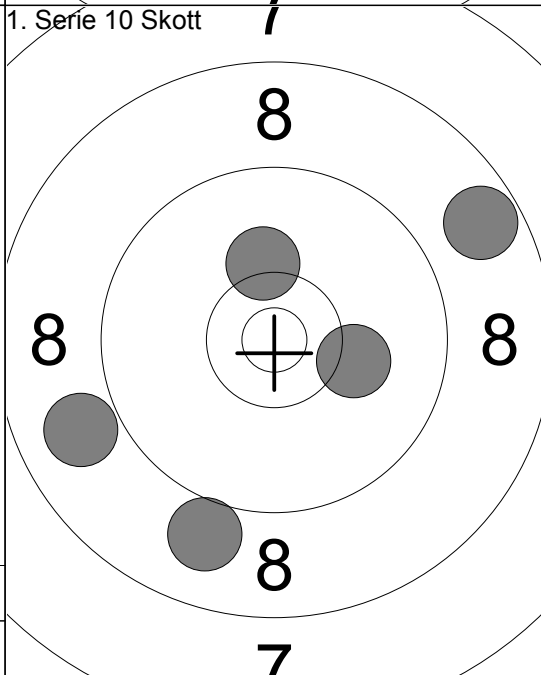

6:	8.7 ↗
7:	8.9 ↖
8:	10.2 ➔
9:	9.0 ↓
10:	10.2 ↑
Serie	45.0
Total	279.0

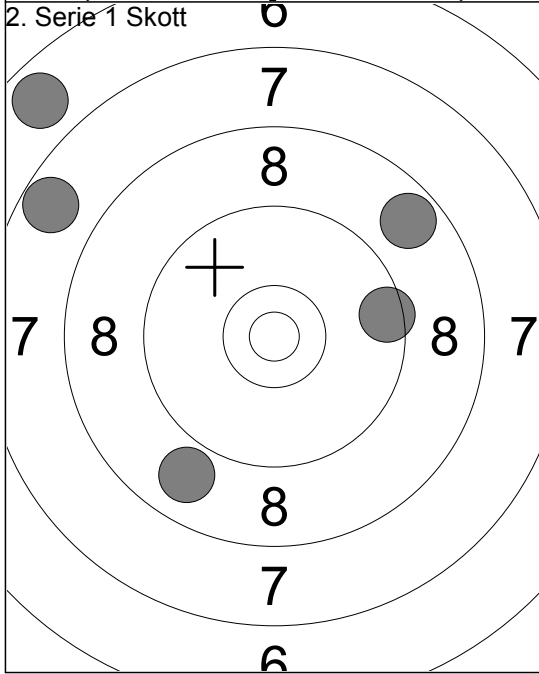

1:	8.9 ↓
2:	7.7 ↖
3:	8.7 ↗
4:	9.5 ➔
5:	6.8 ↖
Serie	38.0
Total	317.0

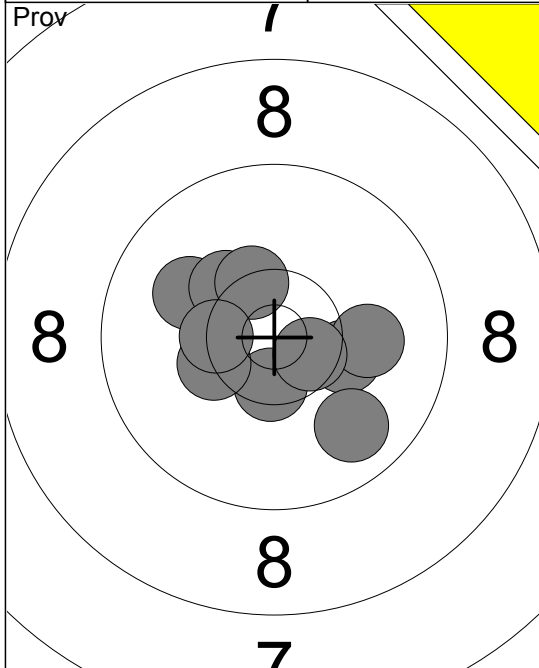

1:	10.0	↖
2:	10.5	x↓
3:	10.3	→
4:	10.3	x
5:	10.1	→
6:	10.3	↖
7:	10.4	x↗
8:	10.6	x↘
9:	10.4	x
10:	9.8	↘
Serie		99.0
Total		187.0

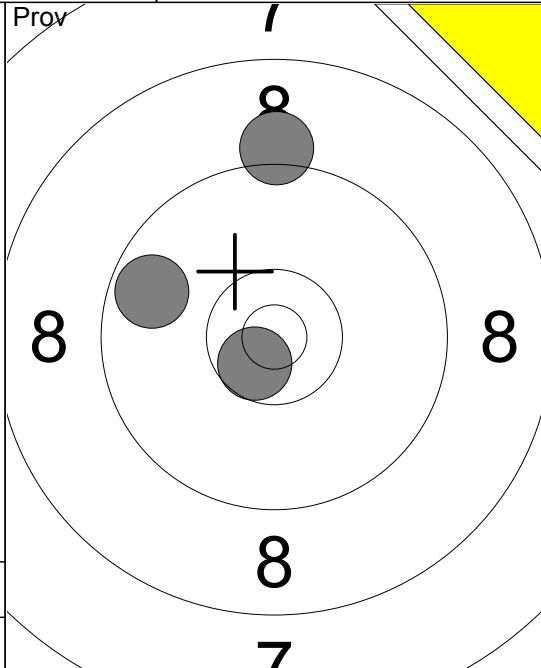

11:	10.6	x↘
12:	9.1	↑
13:	9.7	↖
Serie		28.0
Total		187.0

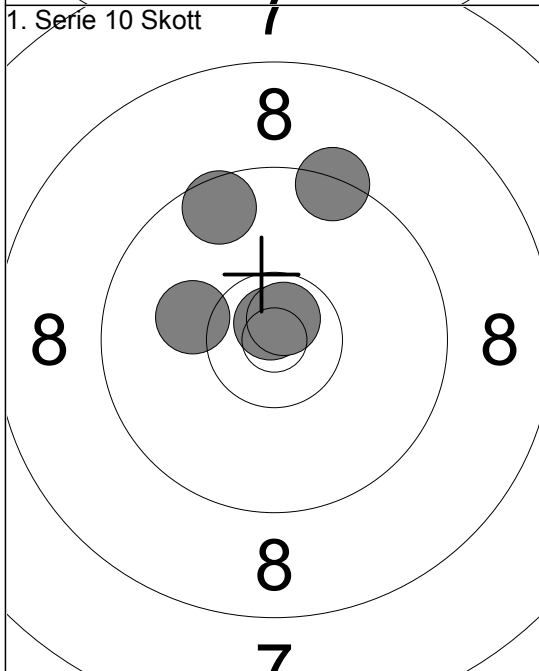

1:	10.8	x↗
2:	9.4	↗
3:	9.6	↗
4:	10.1	↖
5:	10.7	x↗
Serie		48.0
Total		235.0

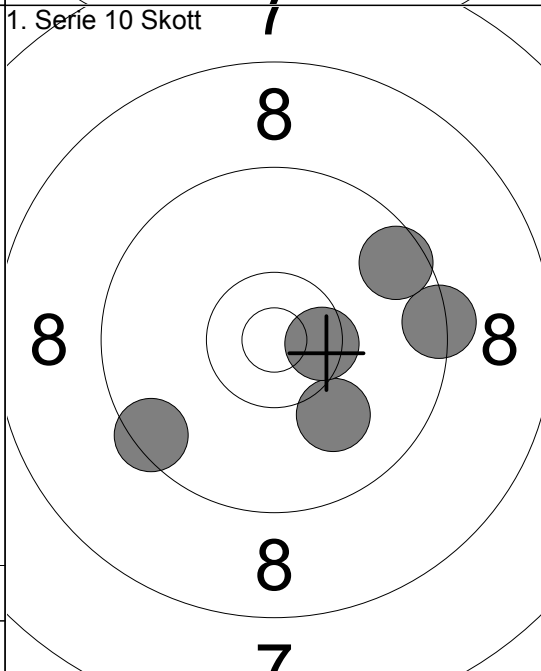

6:	10.0	↘
7:	9.4	→
8:	9.6	↗
9:	10.5	x>
10:	9.5	↘
Serie		47.0
Total		282.0

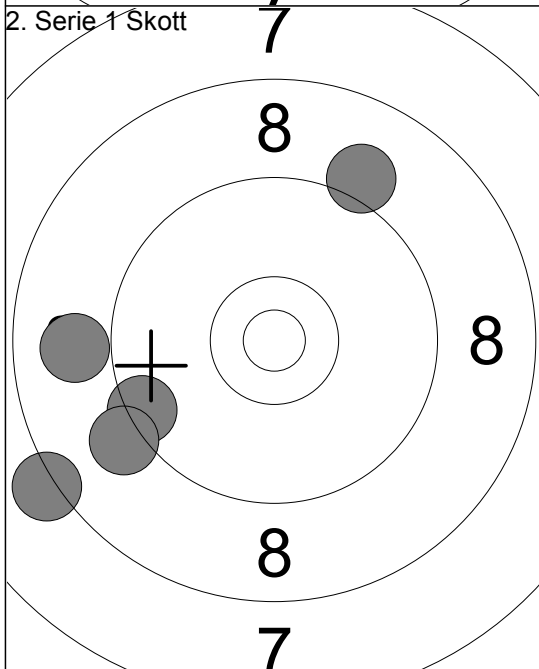

1:	9.1	↗
2:	8.9	↖
3:	9.4	↖
4:	9.1	↖
5:	8.2	↖
Serie		43.0
Total		325.0

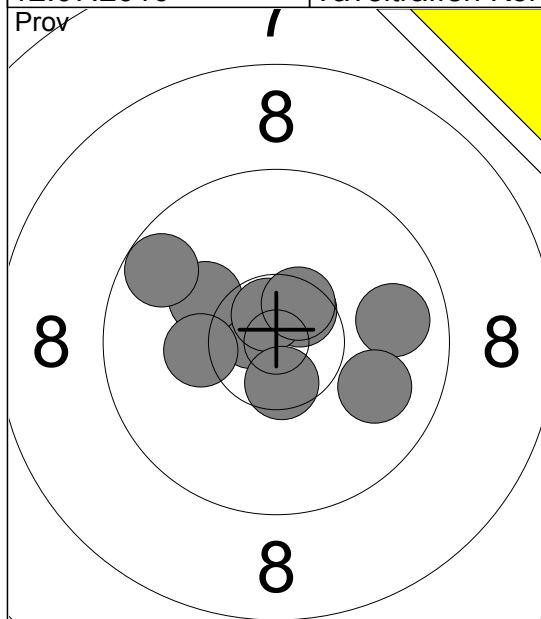

- 1: 9.8 →
- 2: 9.9 ↘
- 3: 10.7 ↗
- 4: 10.2 ↖
- 5: 9.7 ↙
- 6: 10.2 ←
- 7: 10.6 ↗
- 8: 10.7 ↗
- 9: 10.6 ↓
- 10: 10.5 ↗

Serie 97.0

Total 186.0

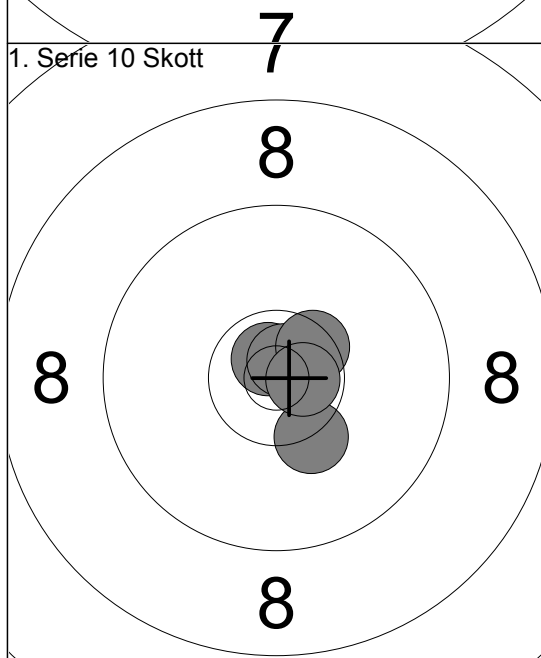

- 1: 10.8 ↗
- 2: 10.8 ↗
- 3: 10.5 ↗
- 4: 10.3 ↓
- 5: 10.7 ×

Serie 50.0

Total 236.0

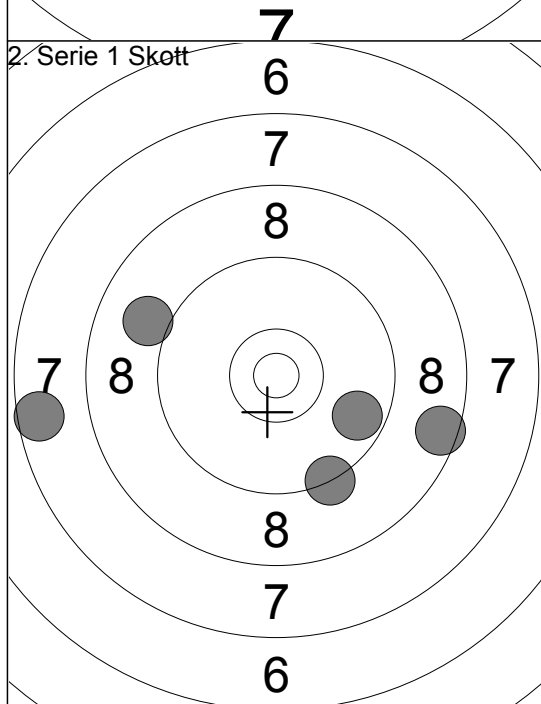

- 1: 9.7 →
- 2: 7.6 ←
- 3: 8.5 →
- 4: 9.0 ↖
- 5: 9.3 ↓

Serie 42.0

Total 327.0

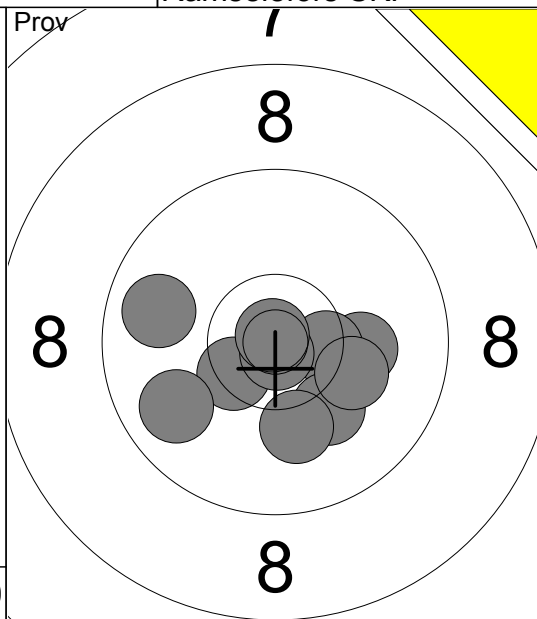

- 11: 10.1 →
- 12: 10.5 ×
- 13: 10.5 ×
- 14: 10.8 ↓
- 15: 10.1 ↓
- 16: 10.1 ↓
- 17: 10.2 →
- 18: 9.8 ←
- 19: 9.8 ←
- 20: 10.9 ↗

Serie 98.0

Total 186.0

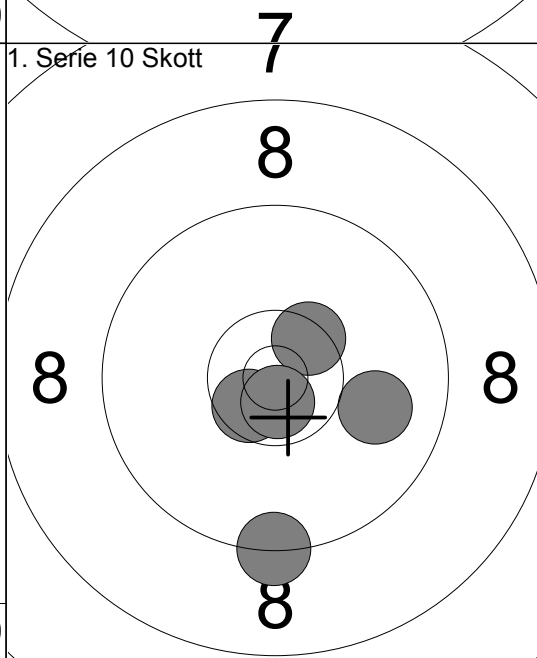

- 6: 10.0 →
- 7: 9.3 ↓
- 8: 10.6 ×
- 9: 10.5 ↗
- 10: 10.7 ↓

Serie 49.0

Total 285.0

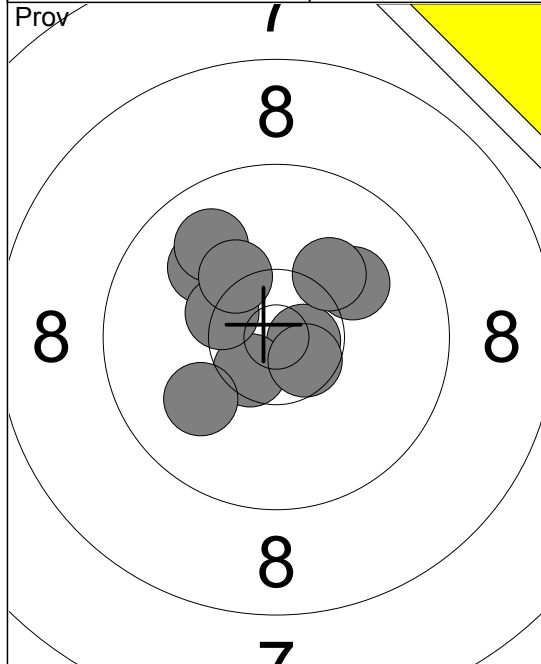

1:	10.0 ↙
2:	9.9 ↖
3:	10.7x ➤
4:	10.5x ↘
5:	10.4x ↘
6:	10.3 ↖
7:	10.1 ↗
8:	10.2 ↗
9:	10.0 ↙
10:	10.6x ↘
Serie 99.0	
Total 186.0	

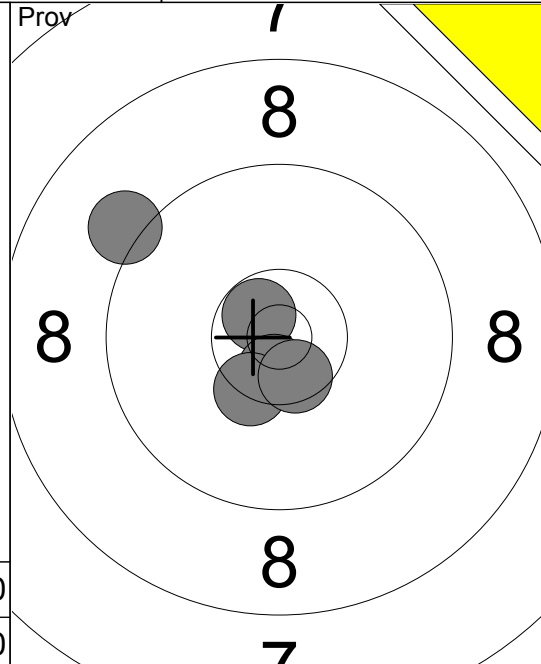

11:	9.1 ↖
12:	10.7x ↘
13:	10.6x ↘
14:	10.4x ↘
15:	10.5x ↘
Serie 49.0	
Total 186.0	

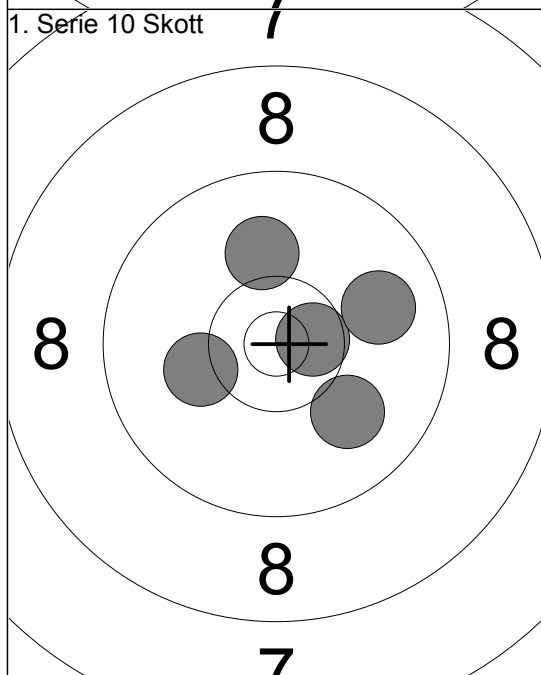

1:	10.6x ➤
2:	10.0 ↘
3:	10.2 ↙
4:	9.9 ➔
5:	10.1 ↗
Serie 49.0	
Total 235.0	

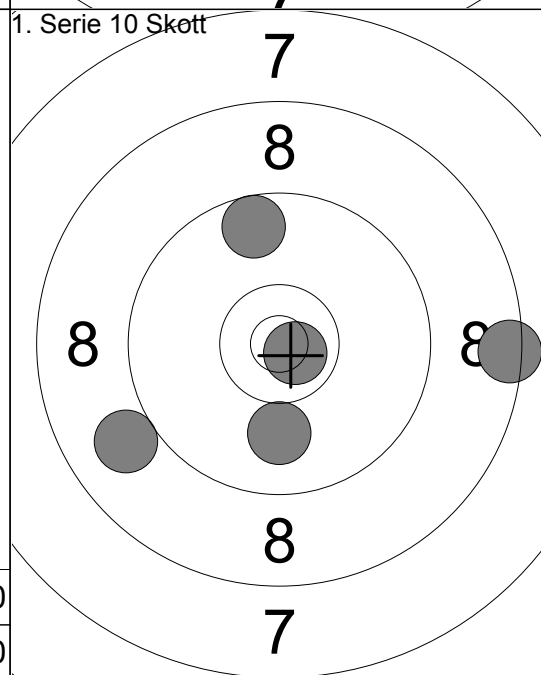

6:	10.0 ↓
7:	10.7x ↘
8:	9.0 ↙
9:	9.6 ↗
10:	8.4 ➔
Serie 46.0	
Total 281.0	

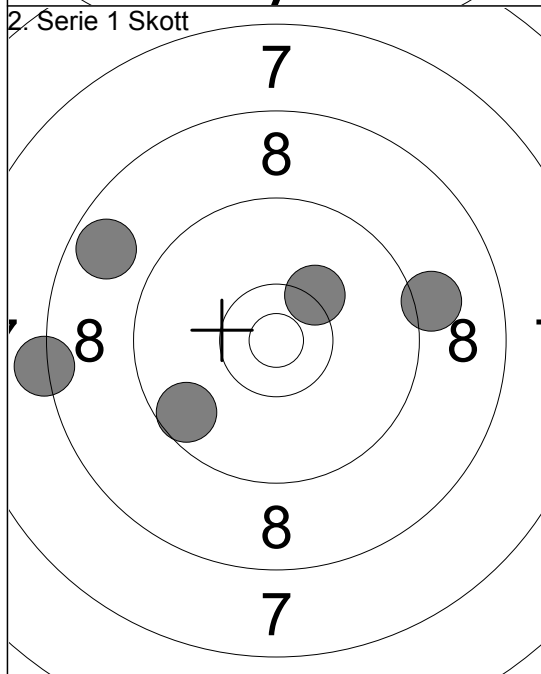

1:	10.3 ↗
2:	8.3 ↙
3:	8.7 ↙
4:	9.1 ➔
5:	9.6 ↙
Serie 44.0	
Total 325.0	

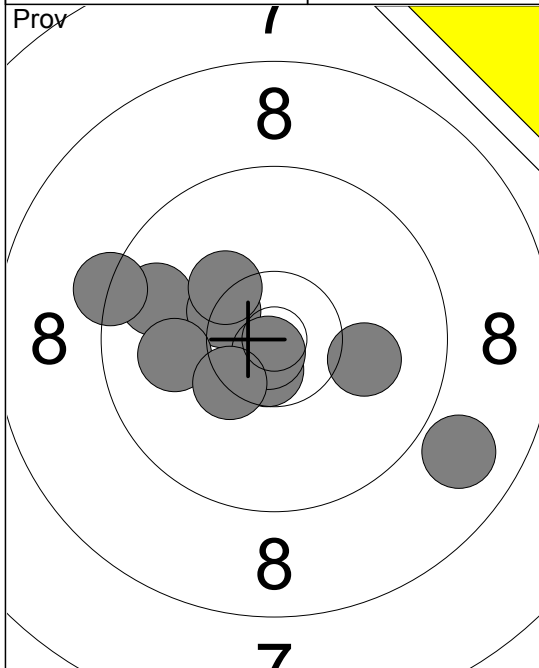

- 1: 9.8 ←
- 2: 9.3 ←
- 3: 10.6x↓
- 4: 10.1 →
- 5: 10.4x↖
- 6: 8.9 ↘
- 7: 10.3 ↗
- 8: 10.0 ←
- 9: 10.8x↓
- 10: 10.4x↘

Serie 96.0

Total 185.0

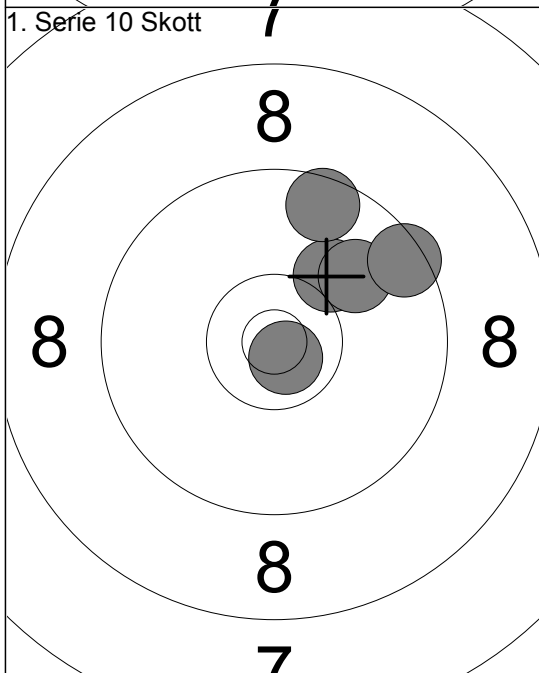

- 1: 10.8x↓
- 2: 10.1 ↗
- 3: 10.0 ↗
- 4: 9.5 ↗
- 5: 9.6 ↗

Serie 48.0

Total 233.0

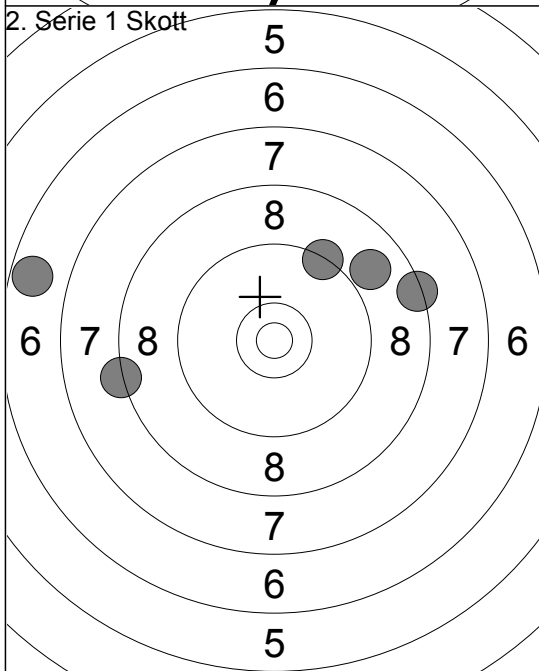

- 1: 9.3 ↗
- 2: 6.7 ←
- 3: 8.4 →
- 4: 8.3 ←
- 5: 8.9 ↗

Serie 39.0

Total 319.0

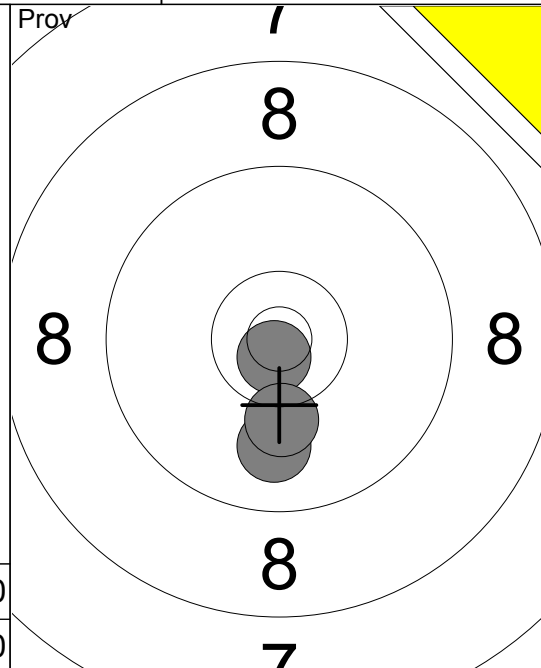

- 11: 10.8x↓
- 12: 9.9 ↓
- 13: 10.2 ↓

Serie 29.0

Total 185.0

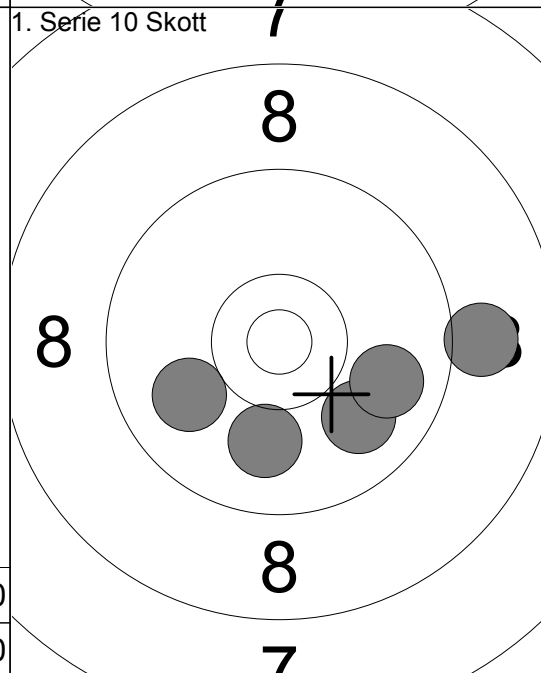

- 6: 10.0 ↓
- 7: 9.9 ↘
- 8: 9.0 →
- 9: 10.0 ←
- 10: 9.9 →

Serie 47.0

Total 280.0

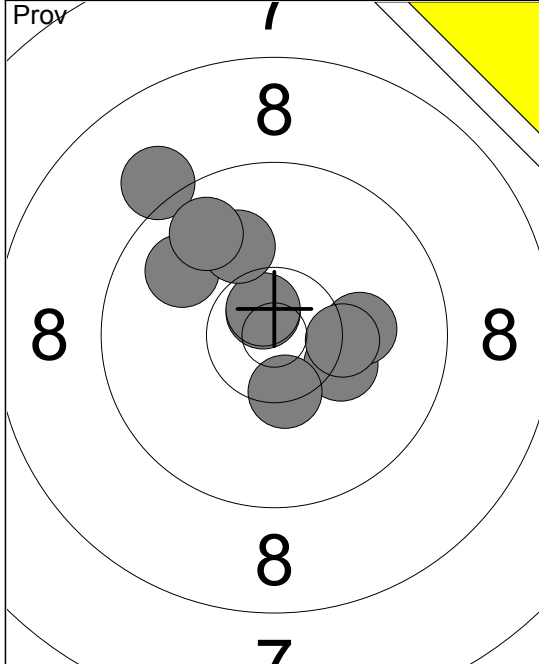

1:	10.7x ↗
2:	10.3 ↘
3:	10.1 →
4:	10.7x ↗
5:	9.9 ↖
6:	9.1 ↖
7:	10.3x ↘
8:	10.0 ↖
9:	9.8 ↖
10:	10.4x ↘
Serie	97.0
Total	186.0

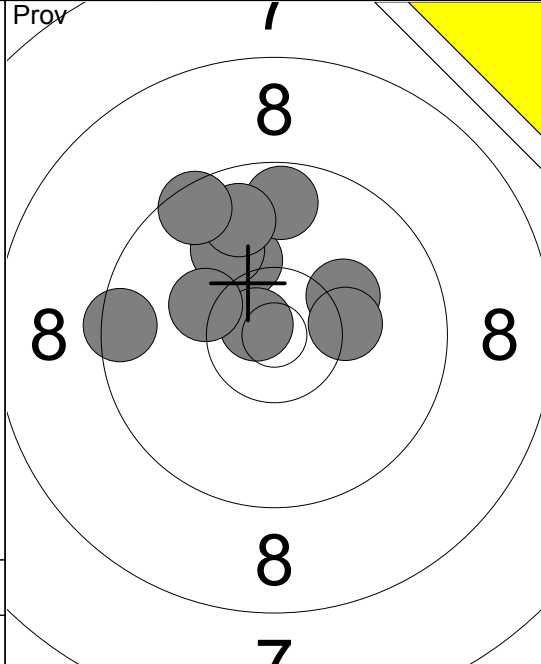

11:	10.2 ↗
12:	10.8x ↘
13:	10.0 ↖
14:	10.2 ↗
15:	9.7 ↑
16:	9.5 ←
17:	10.3 →
18:	9.8 ↑
19:	10.2 ↖
20:	9.5 ↖
Serie	96.0
Total	186.0

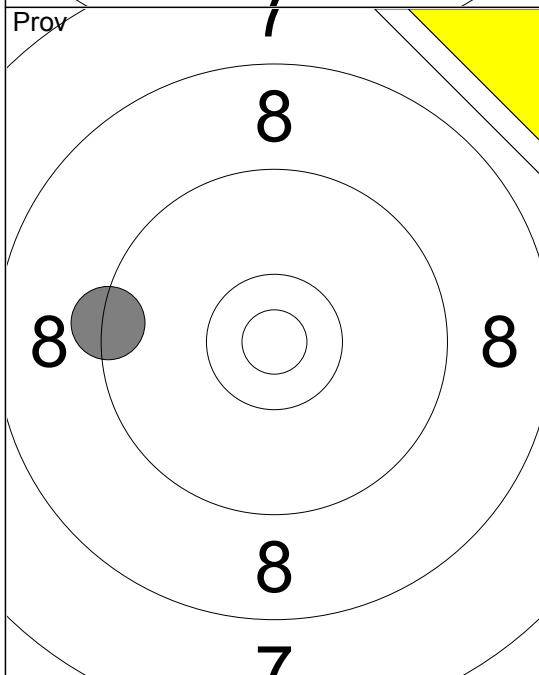

21:	9.4 ←
Serie	9.0
Total	186.0

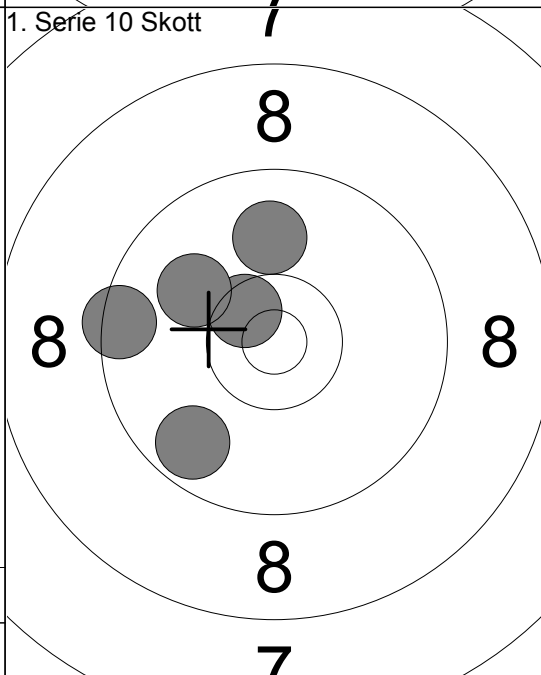

1:	10.5x ↘
2:	10.0 ↑
3:	9.5 ←
4:	9.7 ↘
5:	10.0 ↖
Serie	48.0
Total	234.0

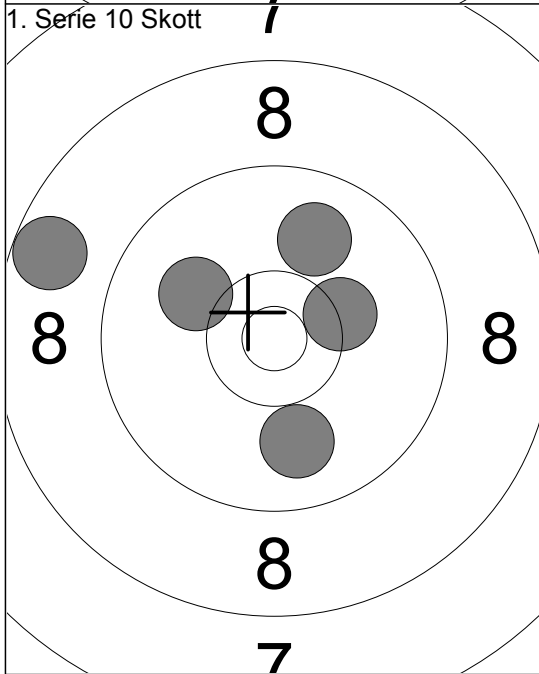

6:	9.9 ↖
7:	10.1 ↖
8:	8.7 ←
9:	10.3 →
10:	9.9 ↘
Serie	46.0
Total	280.0

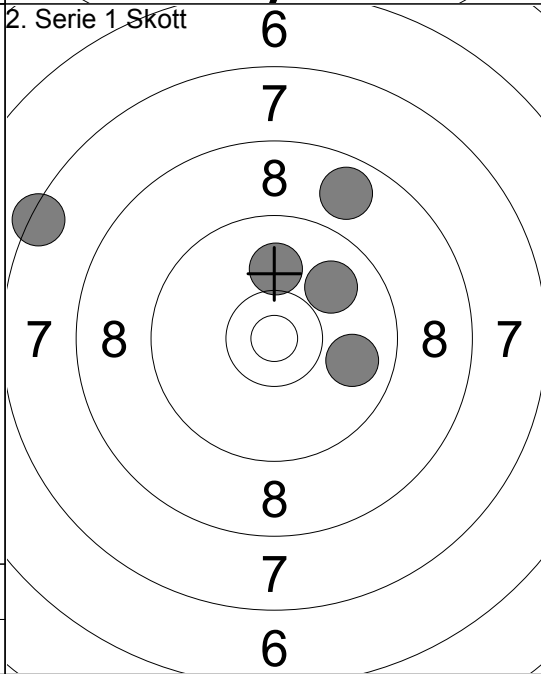

1:	7.4 ←
2:	9.9 ↗
3:	10.0 ↑
4:	9.9 →
5:	8.8 ↖
Serie	43.0
Total	323.0

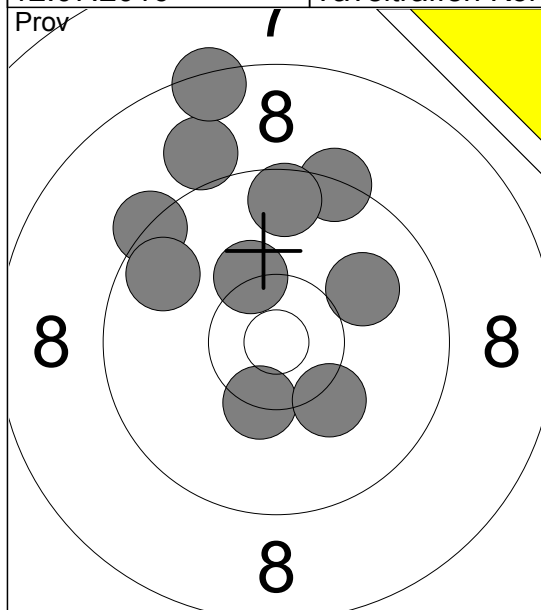

- 1: 10.4x ↘
- 2: 10.2 ↘
- 3: 9.3 ↗
- 4: 10.3 ↗
- 5: 9.7 ↗
- 6: 9.4 ↗
- 7: 9.0 ↗
- 8: 10.0 ↗
- 9: 8.4 ↗
- 10: 9.6 ↗

Serie 93.0

Total 186.0

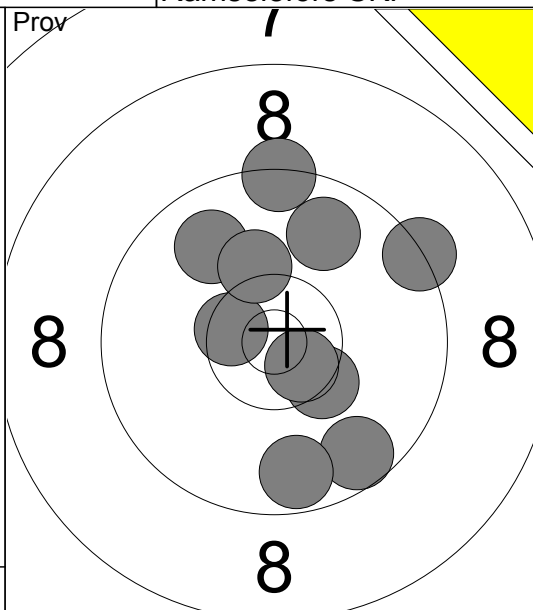

- 11: 9.3 ↗
- 12: 9.8 ↗
- 13: 10.5x ↘
- 14: 9.9 ↗
- 15: 10.2 ↗
- 16: 9.6 ↘
- 17: 9.7 ↘
- 18: 10.4x ↘
- 19: 9.4 ↗
- 20: 10.6x ↘

Serie 94.0

Total 186.0

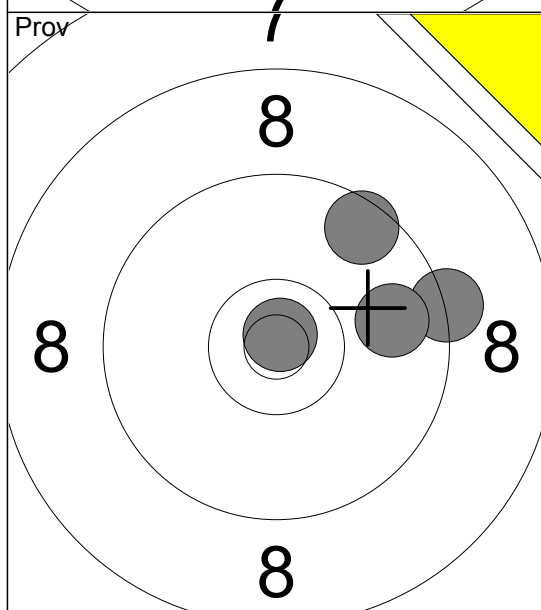

- 21: 9.3 →
- 22: 9.5 ↗
- 23: 9.8 →
- 24: 10.8x ↗

Serie 37.0

Total 186.0

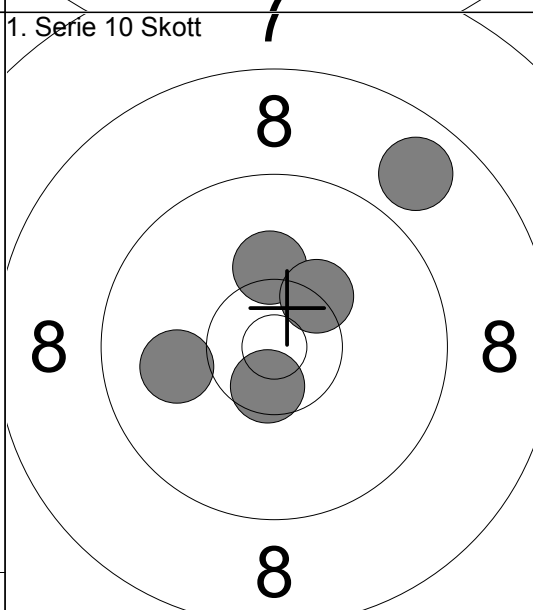

- 1: 10.6x ↘
- 2: 10.2 ↗
- 3: 10.0 ←
- 4: 10.3x ↗
- 5: 8.8 ↗

Serie 48.0

Total 234.0

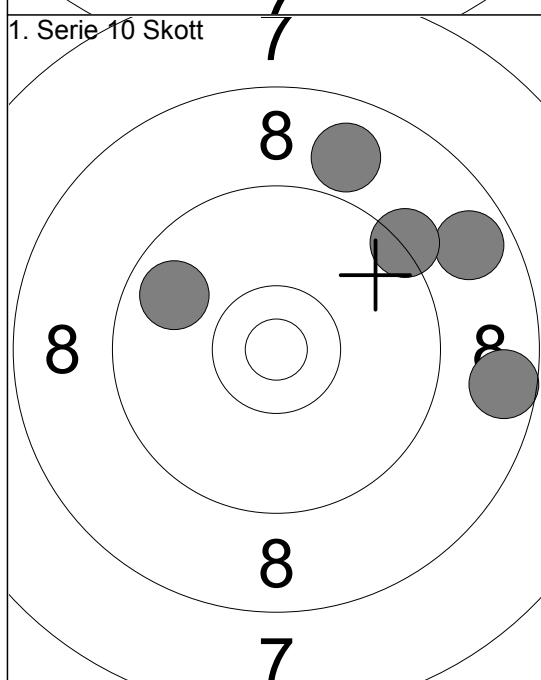

- 6: 9.8 ↗
- 7: 8.7 ↗
- 8: 8.9 ↗
- 9: 9.3 ↗
- 10: 8.6 →

Serie 42.0

Total 276.0

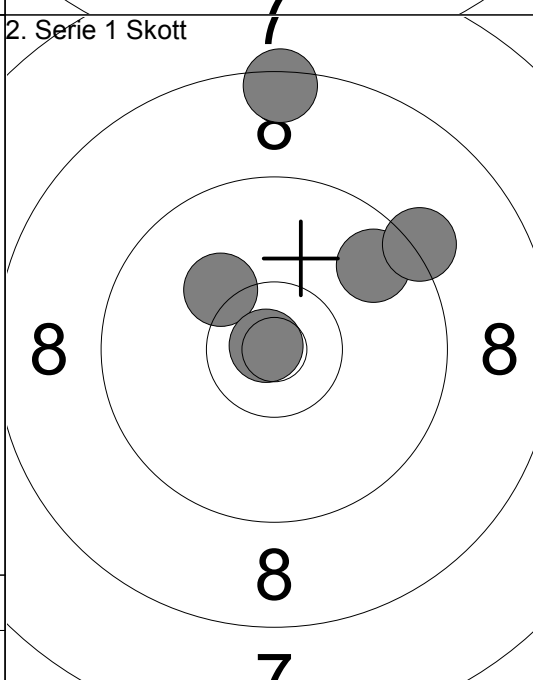

- 1: 8.4 ↗
- 2: 10.2 ↗
- 3: 9.7 ↗
- 4: 9.2 ↗
- 5: 10.9x ↘

Serie 46.0

Total 322.0

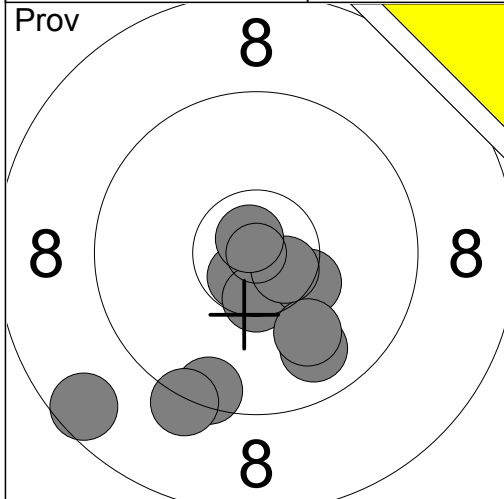

1:	8.6	↙
2:	10.7x	↙
3:	10.5x	↓
4:	9.5	↘
5:	10.3x	↘
6:	9.8	↘
7:	10.0	↘
8:	9.3	↘
9:	10.6x	↘
10:	10.8x	↗

Serie	95.0
Total	182.0

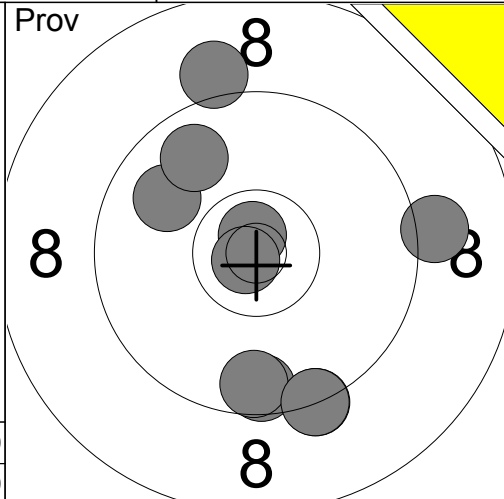

11:	9.6	↓
12:	9.3	↓
13:	9.1	→
14:	9.6	↓
15:	9.1	↑
16:	9.3	↓
17:	10.8x	↑
18:	9.9	↗
19:	10.8x	↙
20:	9.8	↗

Serie	92.0
Total	182.0

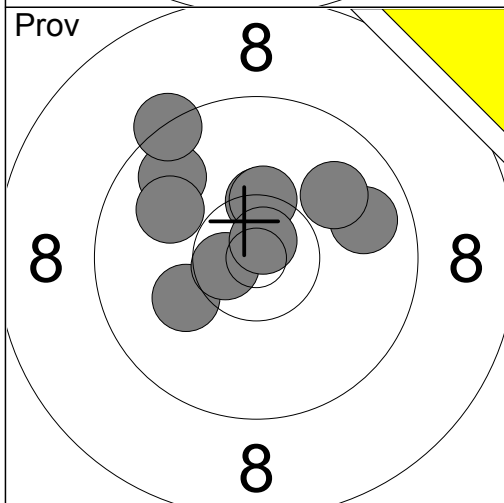

21:	9.8	↗
22:	9.8	→
23:	10.4x	↑
24:	9.3	↗
25:	9.9	↗
26:	10.4x	↑
27:	10.1	↙
28:	9.9	↙
29:	10.6x	←
30:	10.8x	↑

Serie	95.0
Total	182.0

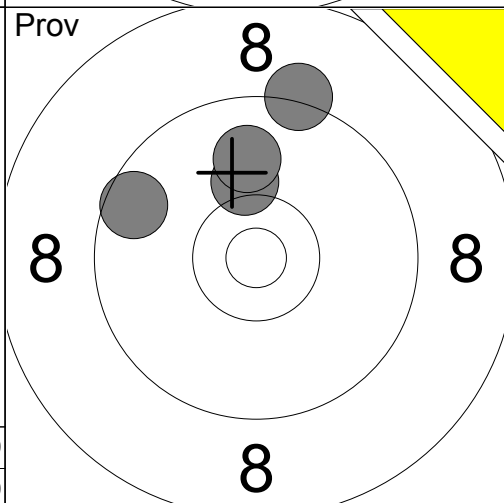

31:	10.2	↑
32:	9.6	↙
33:	9.9	↑
34:	9.2	↑

Serie	37.0
Total	182.0

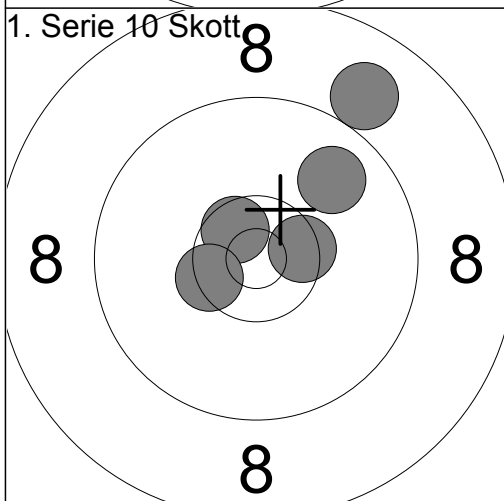

1:	10.6x	↙
2:	9.8	↗
3:	8.9	↗
4:	10.4x	↙
5:	10.5x	→

Serie	47.0
Total	229.0

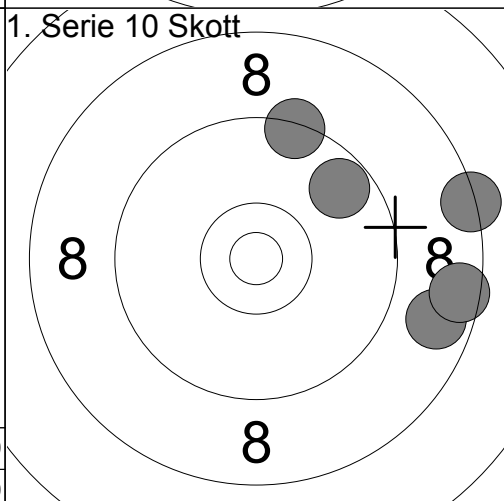

6:	9.4	↑
7:	8.7	→
8:	8.4	→
9:	8.5	→
10:	9.7	↗

Serie	42.0
Total	271.0

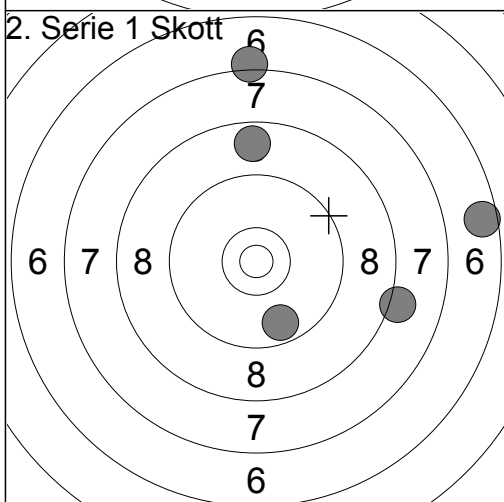

1:	8.7	↑
2:	7.2	↑
3:	6.6	→
4:	8.1	↘
5:	9.7	↓

Serie	38.0
Total	309.0

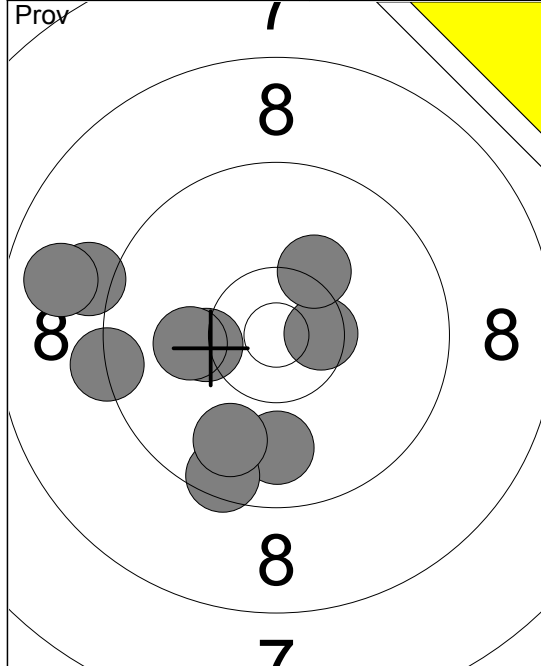

1:	9.1	←
2:	8.8	←
3:	9.9	↓
4:	9.3	←
5:	10.3	←
6:	9.5	↓
7:	10.5x	→
8:	10.2	↗
9:	10.1	←
10:	9.9	↓
Serie	93.0	
Total	180.0	

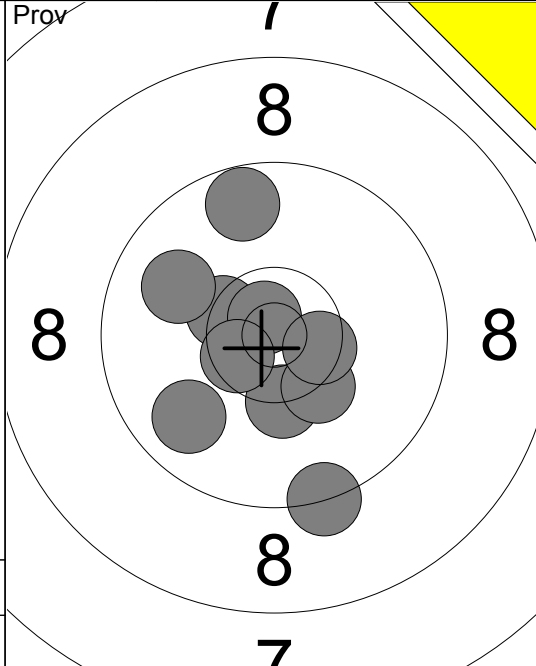

11:	9.3	↓
12:	10.4x	↘
13:	9.9	←
14:	9.7	↑
15:	10.3x	↓
16:	10.8x	↘
17:	9.8	↙
18:	10.5x	↘
19:	10.3x	↘
20:	10.5x	→
Serie	96.0	
Total	180.0	

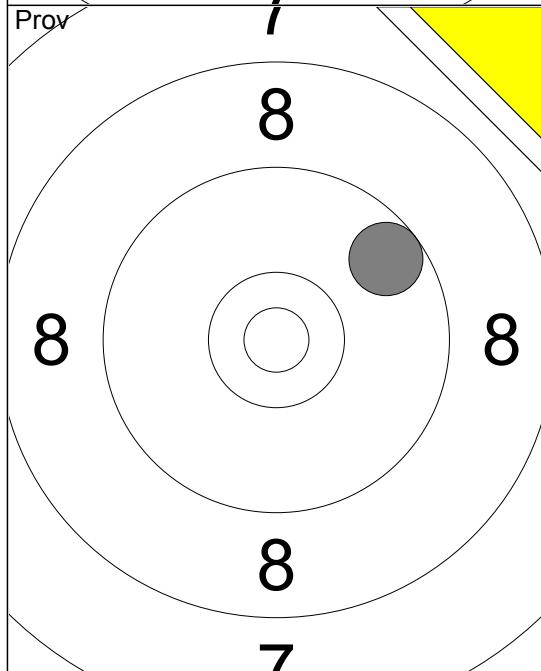

21:	9.6	↗
Serie	9.0	
Total	180.0	

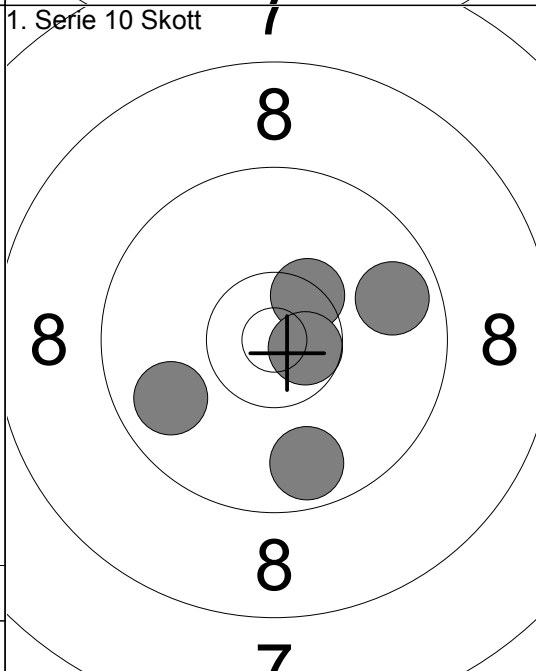

1:	9.8	→
2:	9.8	←
3:	10.4x	↗
4:	9.7	↓
5:	10.6x	→
Serie	47.0	
Total	227.0	

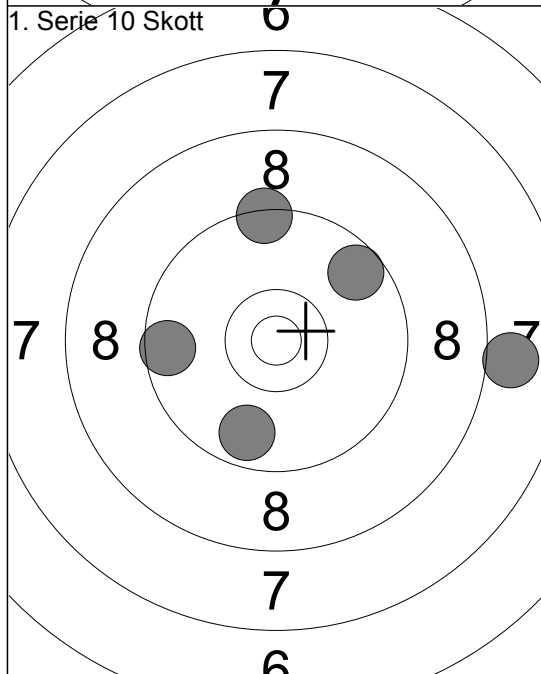

6:	8.0	→
7:	9.6	↗
8:	9.6	←
9:	9.7	↓
10:	9.4	↑
Serie	44.0	
Total	271.0	

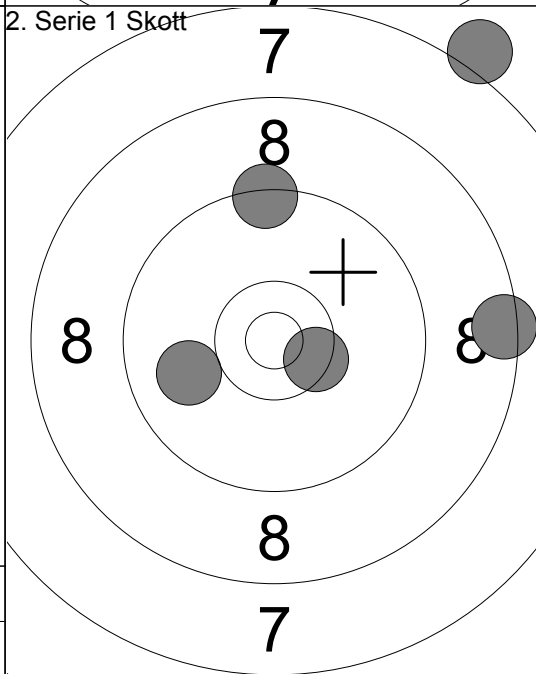

1:	8.4	→
2:	9.4	↑
3:	10.5x	↘
4:	7.1	↗
5:	10.0	←
Serie	44.0	
Total	315.0	

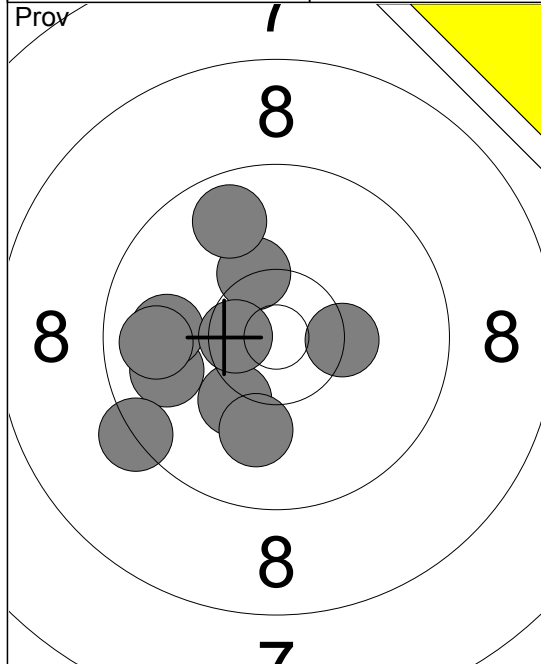

1:	9.9	←
2:	9.3	↙
3:	9.9	←
4:	10.3x	↗
5:	10.3x	→
6:	10.2	↘
7:	10.0	↓
8:	10.6x	←
9:	9.8	←
10:	9.8	↑
Serie		95.0
Total		178.0

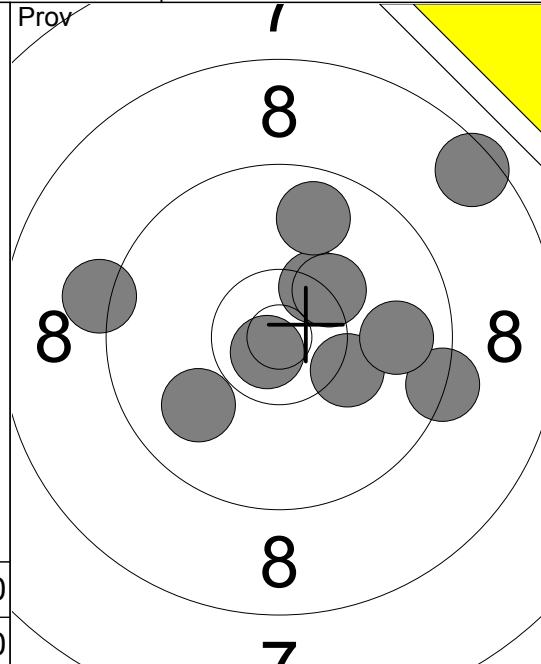

11:	10.4x	↗
12:	9.3	→
13:	10.2	↘
14:	8.5	↗
15:	9.8	→
16:	9.8	↑
17:	10.8x	↘
18:	9.9	↙
19:	9.2	←
20:	10.3x	↗
Serie		93.0
Total		178.0

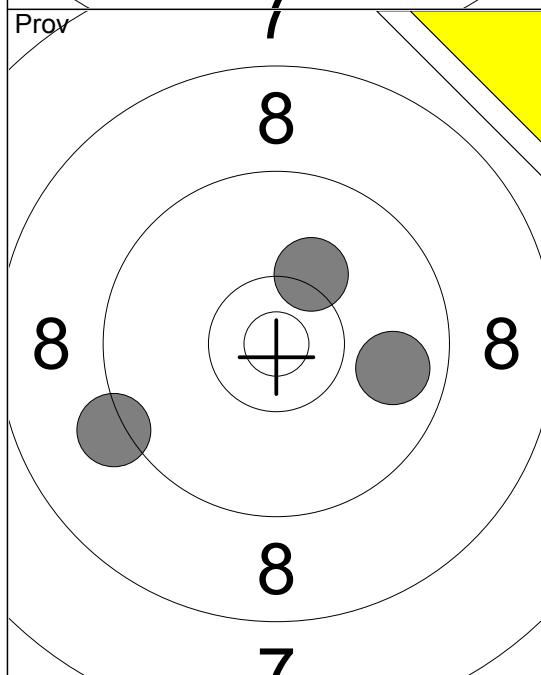

21:	10.2	↗
22:	9.8	→
23:	9.2	↙
Serie		28.0
Total		178.0

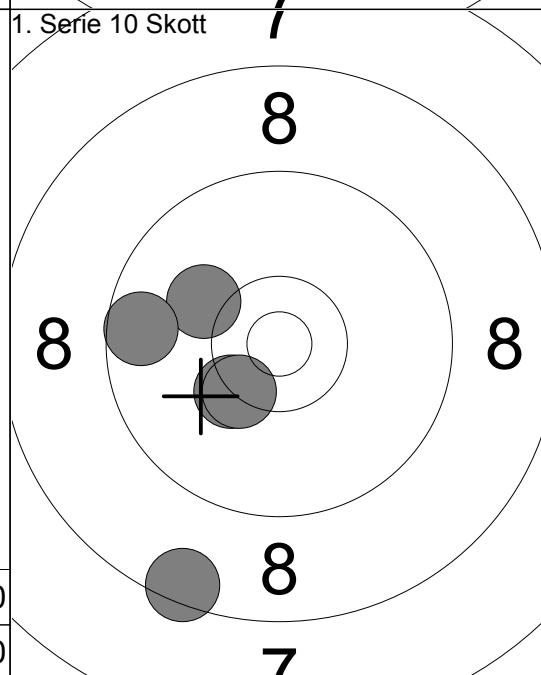

1:	10.1	↖
2:	10.3x	↘
3:	8.5	↘
4:	10.4x	↘
5:	9.6	←
Serie		47.0
Total		225.0

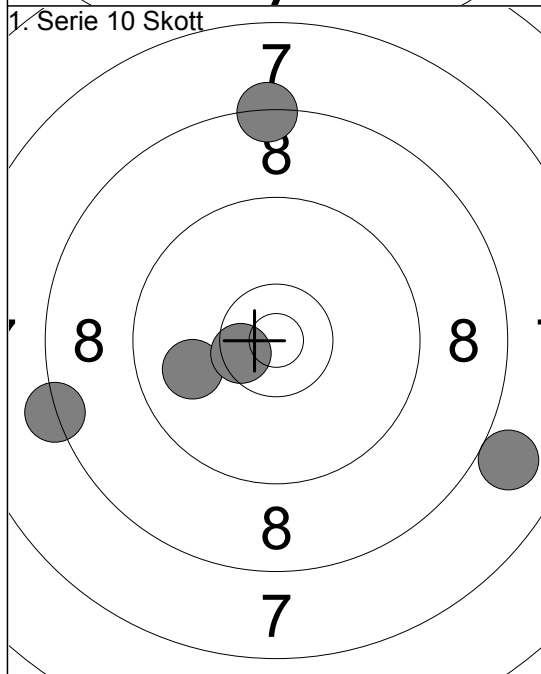

6:	9.9	←
7:	8.3	←
8:	8.0	→
9:	10.5x	↘
10:	8.3	↑
Serie		43.0
Total		268.0

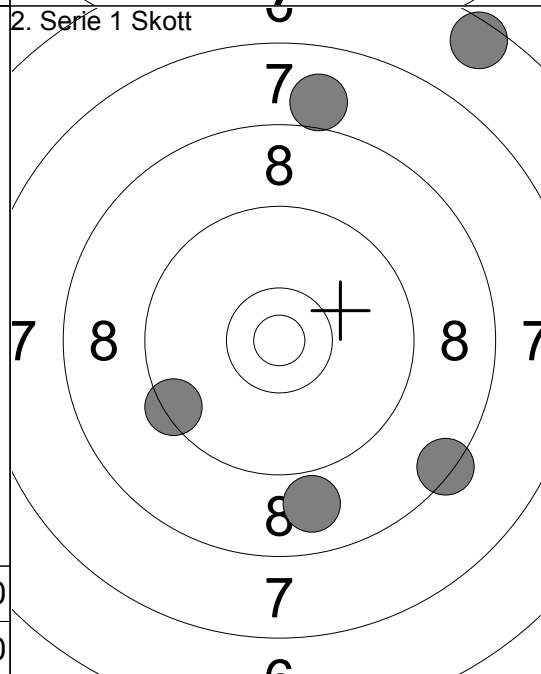

1:	8.0	↑
2:	6.5	↗
3:	8.9	↘
4:	9.4	←
5:	8.4	↘
Serie		39.0
Total		307.0

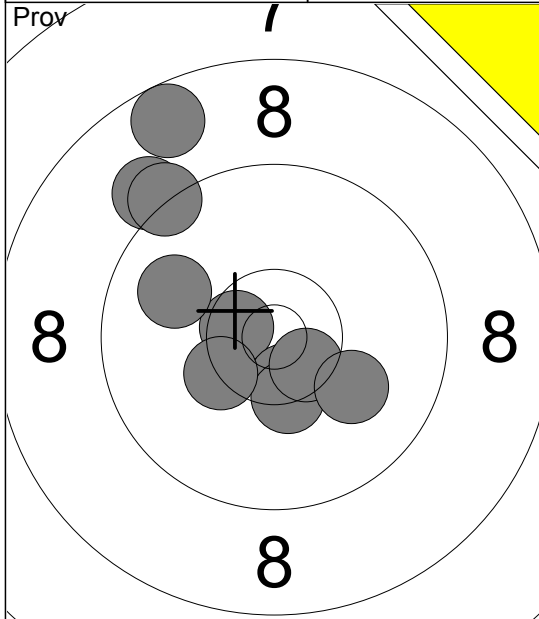

1:	8.7 ↗
2:	9.1 ↗
3:	9.3 ↗
4:	10.6 ✕
5:	10.5 ✕
6:	9.9 ↖
7:	10.4 ✕
8:	10.3 ✕
9:	10.5 ✕
10:	10.1 ↘
Serie	95.0
Total	183.0

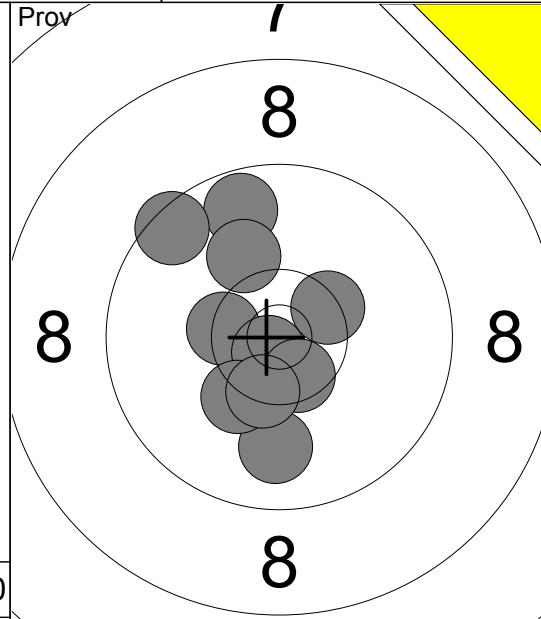

11:	9.7 ↗
12:	10.1 ↗
13:	9.5 ↖
14:	10.4 ✕
15:	10.8 ✕
16:	9.9 ↓
17:	10.5 ✕
18:	10.3 ✕
19:	10.4 ✕
20:	10.4 ✕
Serie	97.0
Total	183.0

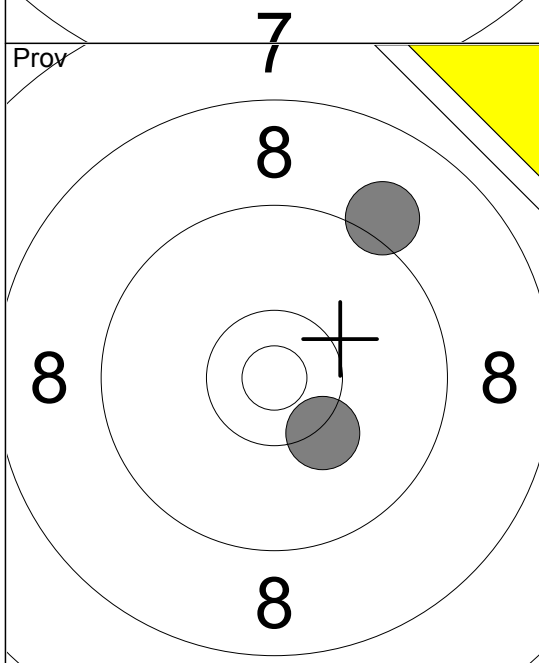

21:	10.2 ✕
22:	9.1 ↗
Serie	19.0
Total	183.0

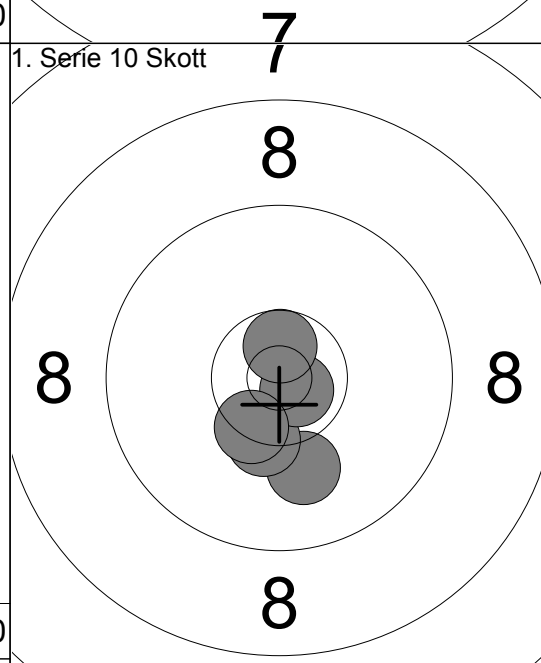

1. Serie 10 Skott	
1:	10.1 ↓
2:	10.3 ✕
3:	10.7 ✕
4:	10.4 ✕
5:	10.6 ✕
Serie	50.0
Total	233.0

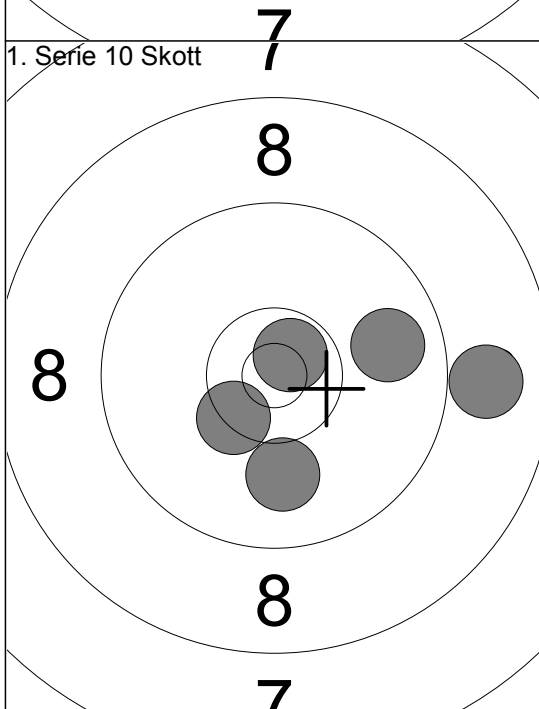

1. Serie 10 Skott	
6:	8.9 →
7:	10.4 ✕
8:	9.8 →
9:	10.7 ✕
10:	10.0 ↓
Serie	47.0
Total	280.0

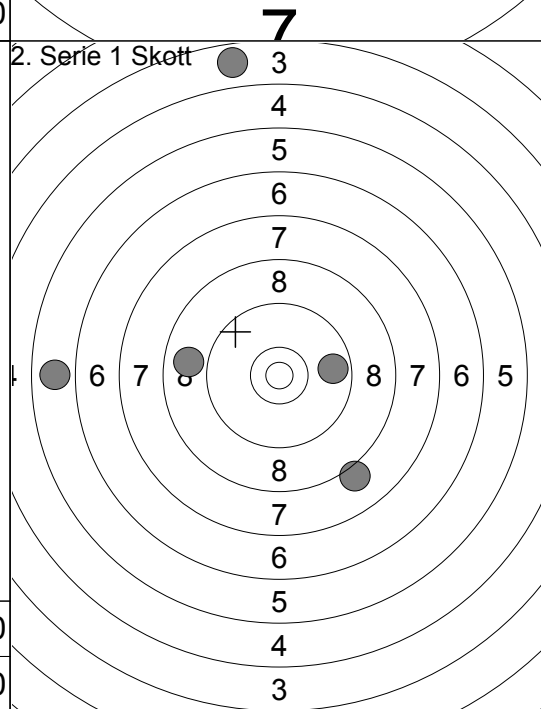

2. Serie 1 Skott	
1:	8.1 ↓
2:	5.8 ←
3:	3.7 ↑
4:	9.7 →
5:	8.9 ←
Serie	33.0
Total	313.0

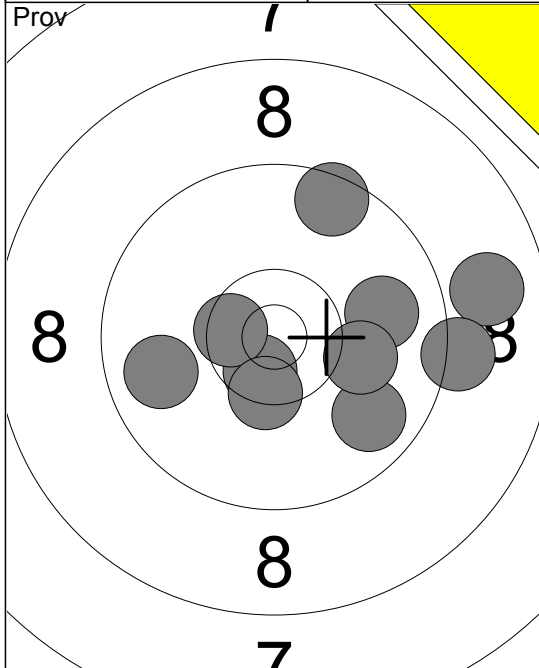

1:	10.6x
2:	9.8 ←
3:	10.5x
4:	9.8 ↘
5:	8.9 →
6:	10.4x
7:	9.9 →
8:	10.1 →
9:	9.5 ↑
10:	9.2 →
Serie	93.0
Total	182.0

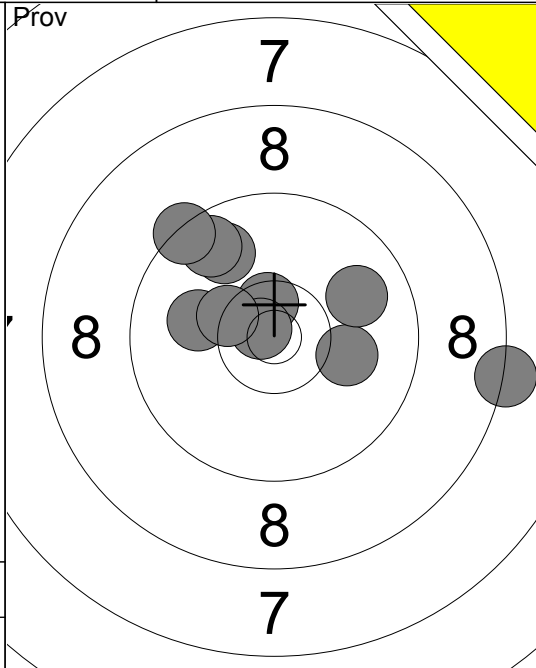

11:	10.6x
12:	10.8x
13:	10.1 ←
14:	9.8 ↗
15:	9.7 ↗
16:	10.1 →
17:	8.3 →
18:	9.9 ↗
19:	9.4 ↗
20:	10.4x
Serie	94.0
Total	182.0

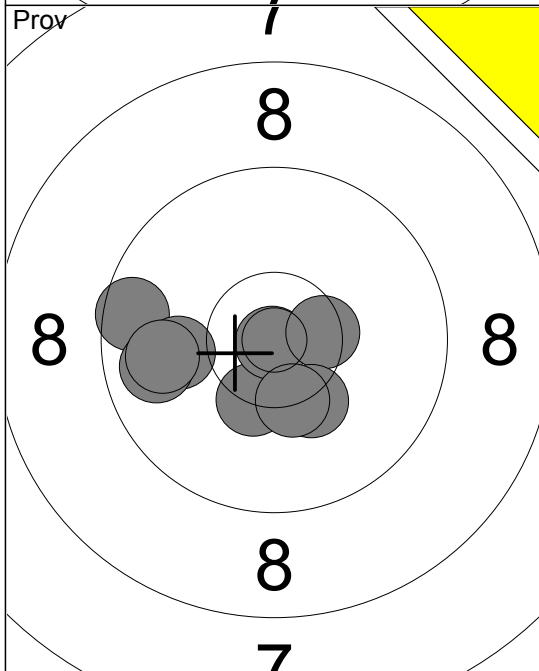

21:	10.3x
22:	9.6 ←
23:	10.9x
24:	10.0 ←
25:	10.5x
26:	10.3 ↘
27:	9.8 ←
28:	10.4x
29:	9.9 ←
Serie	87.0
Total	182.0

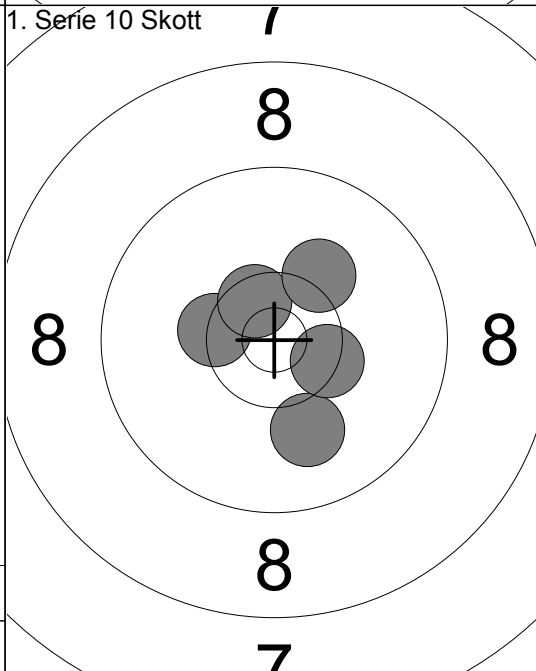

1:	10.4x
2:	10.0 ↘
3:	10.5x
4:	10.4x
5:	10.2 ↗
Serie	50.0
Total	232.0

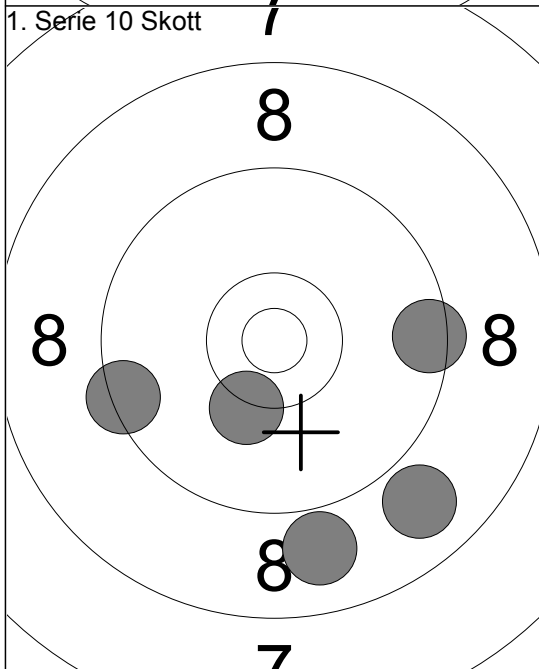

6:	10.3 ↘
7:	9.4 ←
8:	8.9 ↘
9:	9.5 →
10:	8.9 ↘
Serie	44.0
Total	276.0

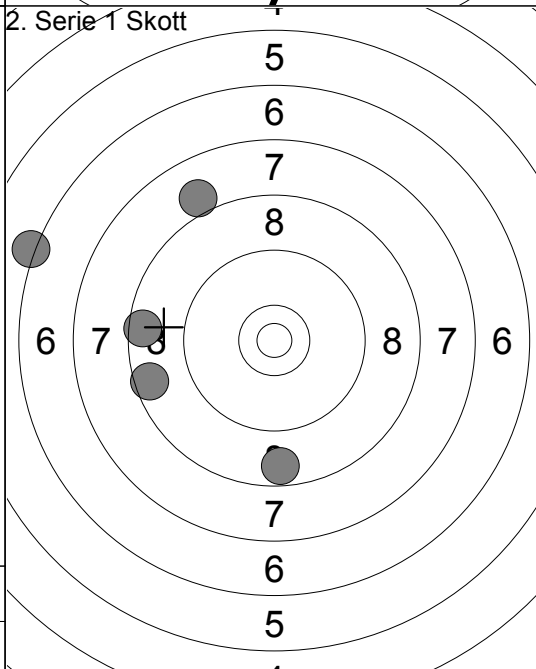

1:	6.2 ←
2:	8.6 ←
3:	8.7 ↘
4:	8.5 ←
5:	8.0 ↗
Serie	38.0
Total	314.0

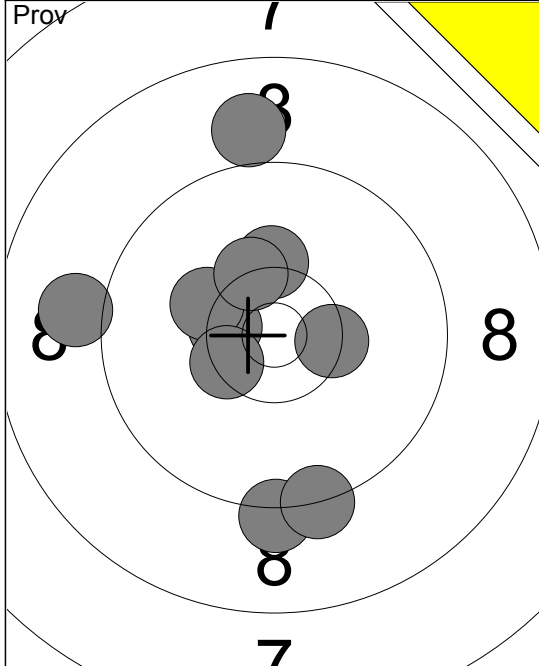

1:	9.2	↓
2:	9.3	↓
3:	9.0	↑
4:	10.3	↑
5:	10.5	✕
6:	9.0	←
7:	10.4	✕→
8:	10.2	↖
9:	10.4	↘
10:	10.3	↖
Serie	96.0	
Total	181.0	

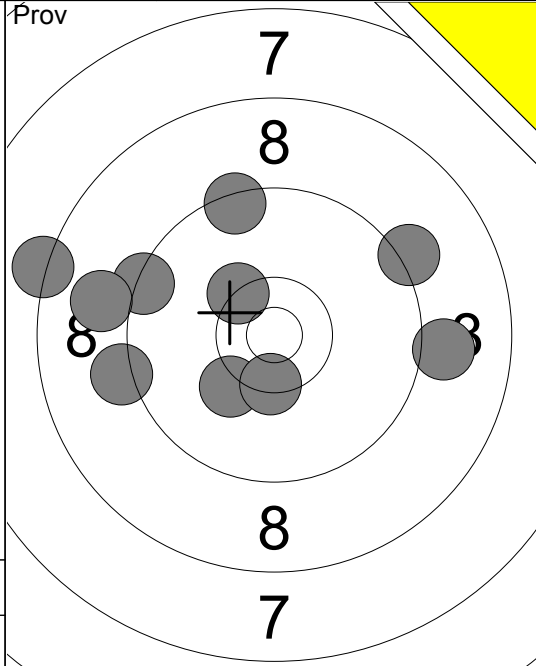

11:	9.4	↑
12:	9.4	↖
13:	8.3	↖
14:	9.0	↖
15:	10.2	↘
16:	9.2	↗
17:	10.4	↘
18:	9.1	→
19:	9.2	↖
20:	10.3	↘
Serie	92.0	
Total	181.0	

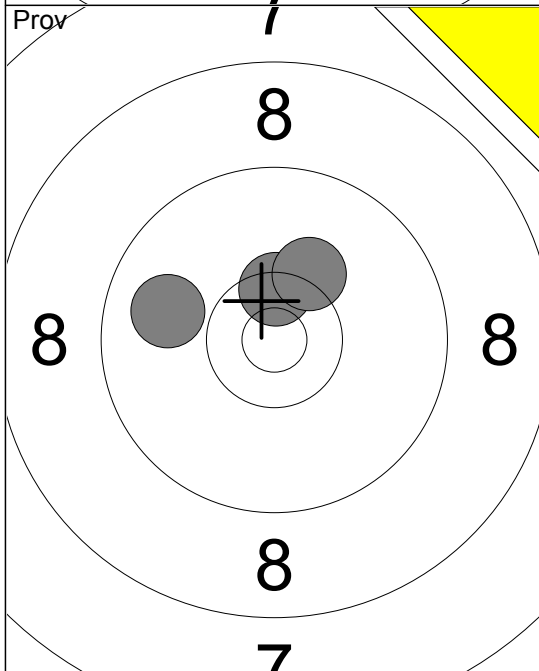

21:	10.5	↑
22:	9.9	←
23:	10.2	↗
Serie	29.0	
Total	181.0	

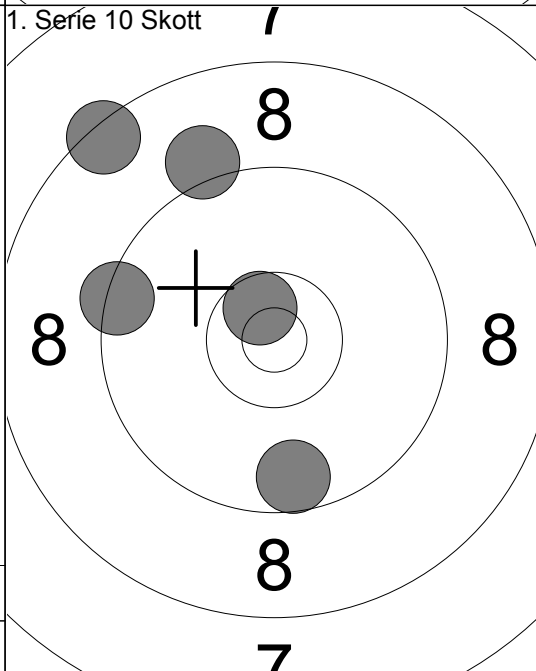

1:	10.6	↖
2:	9.6	↓
3:	9.1	↑
4:	9.4	←
5:	8.4	↗
Serie	45.0	
Total	226.0	

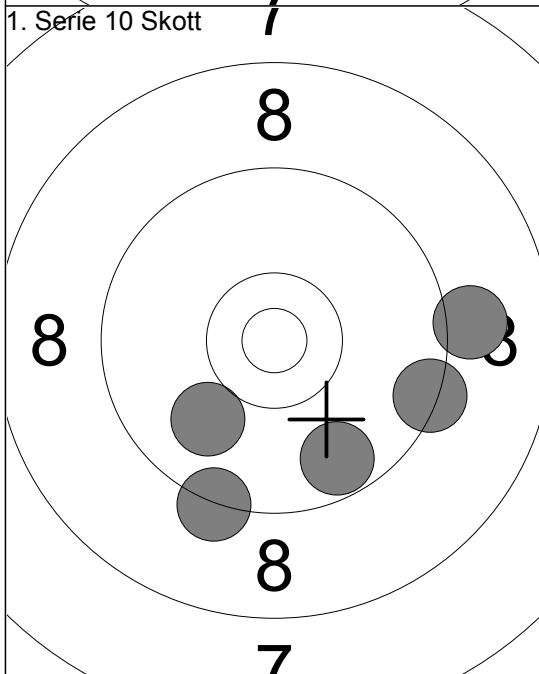

6:	9.7	↓
7:	9.3	↓
8:	9.1	→
9:	10.0	↘
10:	9.4	→
Serie	46.0	
Total	272.0	

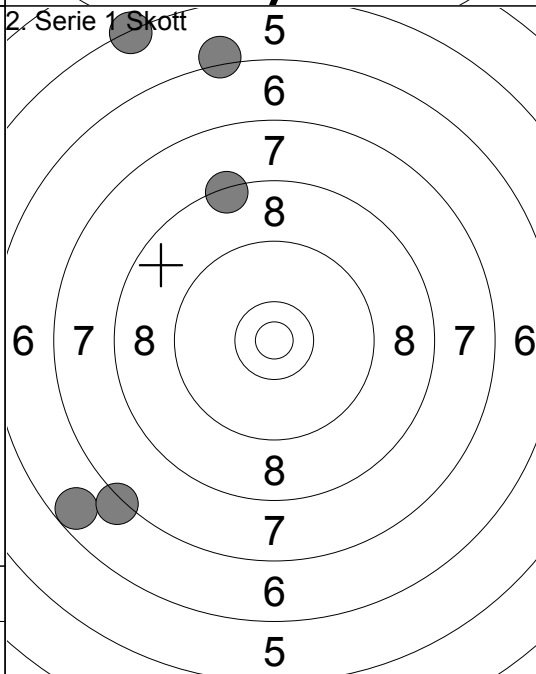

1:	6.7	↘
2:	8.4	↑
3:	7.2	↘
4:	6.2	↑
5:	5.3	↗
Serie	32.0	
Total	304.0	

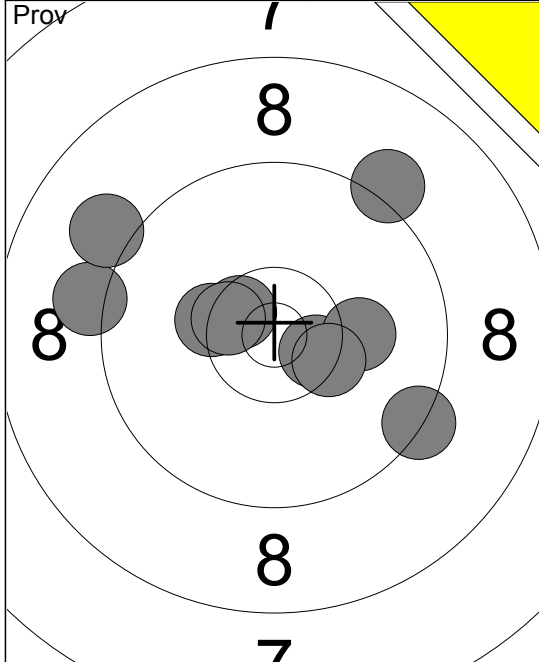

1:	9.2	←
2:	9.1	←
3:	10.5	→
4:	10.6	↘
5:	10.1	→
6:	10.4	→
7:	10.3	↘
8:	9.2	↗
9:	10.5	↘
10:	9.3	↘
Serie	96.0	
Total	176.0	

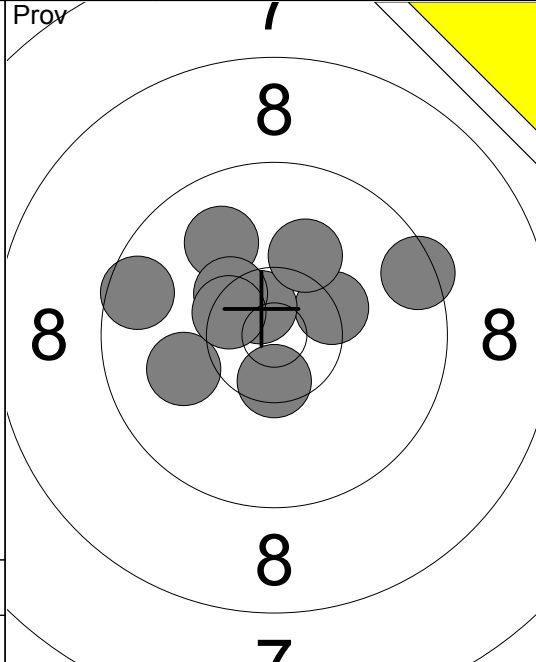

11:	10.3	↗
12:	9.6	←
13:	10.5	↓
14:	10.0	←
15:	10.7	↘
16:	9.9	↗
17:	10.1	↗
18:	10.4	↘
19:	10.5	↘
20:	9.5	↗
Serie	97.0	
Total	176.0	

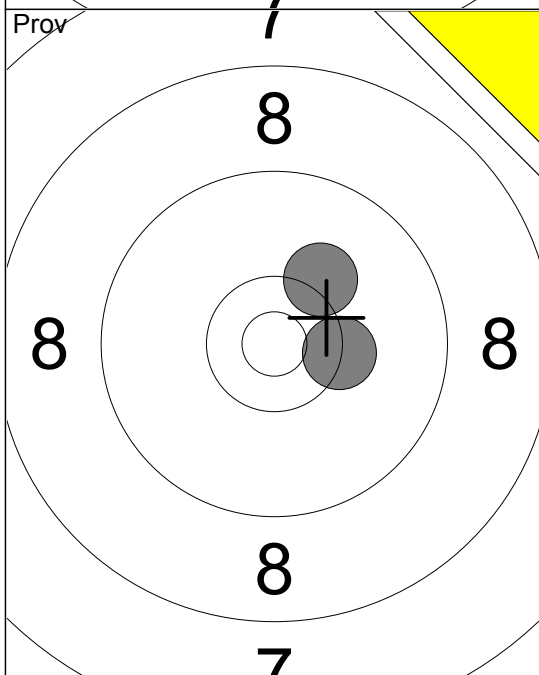

21:	10.2	↗
22:	10.3	→
Serie	20.0	
Total	176.0	

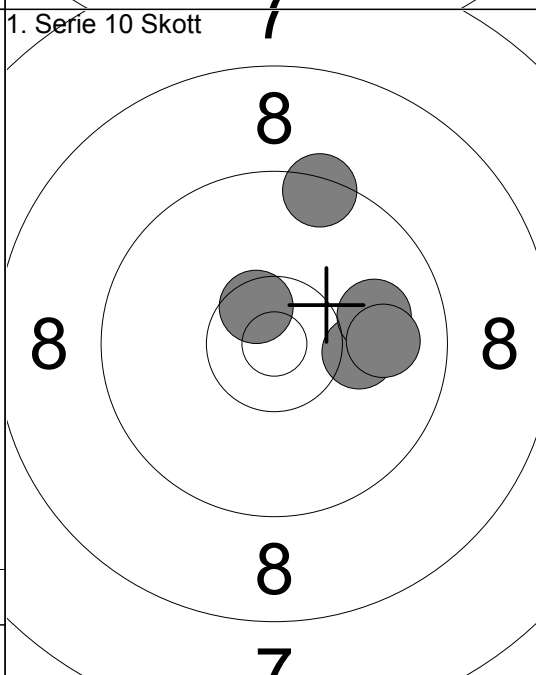

1. Serie 10 Skott		
1:	9.4	↗
2:	10.1	→
3:	10.6	↘
4:	10.0	→
5:	9.9	→
Serie	48.0	
Total	224.0	

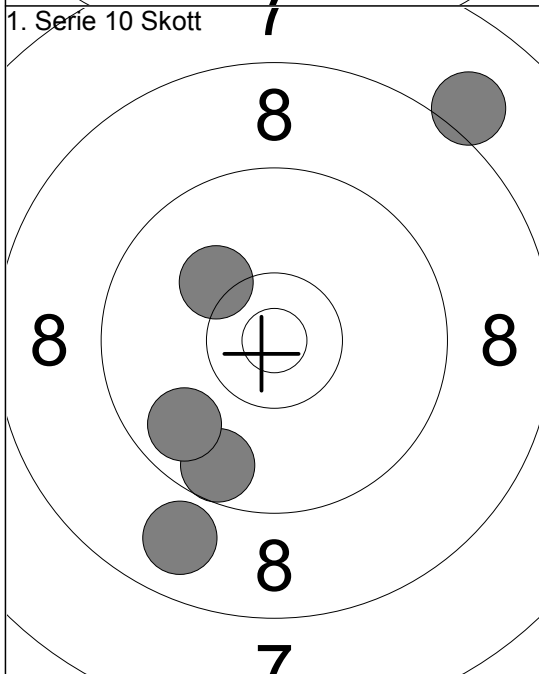

1. Serie 10 Skott		
6:	9.6	↓
7:	9.8	←
8:	8.9	↓
9:	10.2	↖
10:	8.1	↗
Serie	44.0	
Total	268.0	

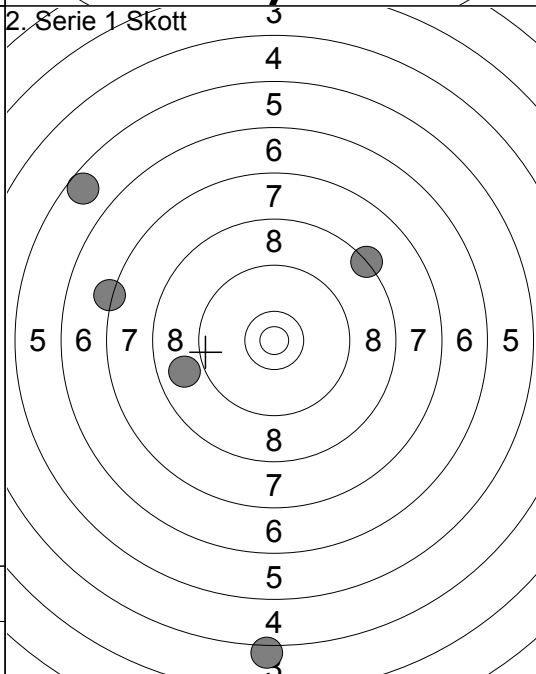

2. Serie 1 Skott		
1:	8.3	↗
2:	4.1	↓
3:	7.2	←
4:	5.6	↖
5:	8.9	←
Serie	32.0	
Total	300.0	

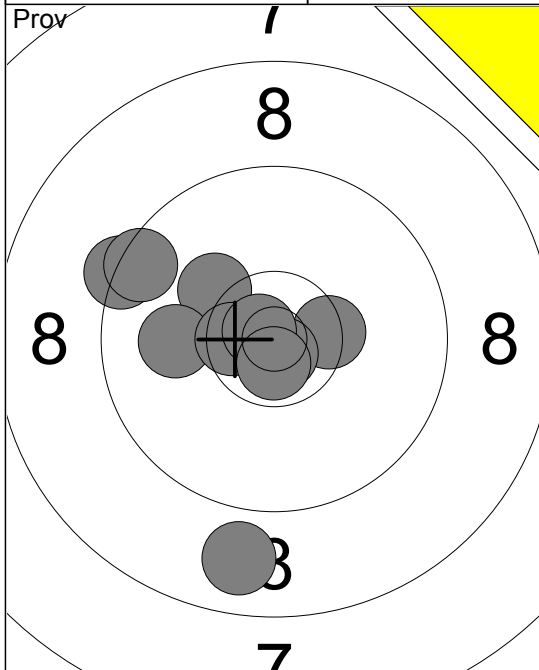

1:	10.4x
2:	9.4
3:	10.2
4:	10.0
5:	10.5x
6:	10.8x
7:	10.8x
8:	10.7x
9:	8.8
10:	9.5
Serie 96.0	
Total 168.0	

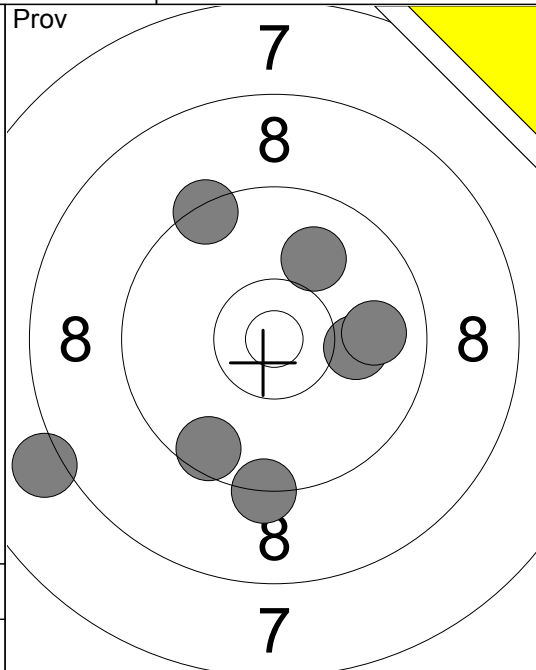

11:	8.1
12:	9.3
13:	10.1
14:	9.6
15:	10.0
16:	9.4
17:	9.9
Serie 64.0	
Total 168.0	

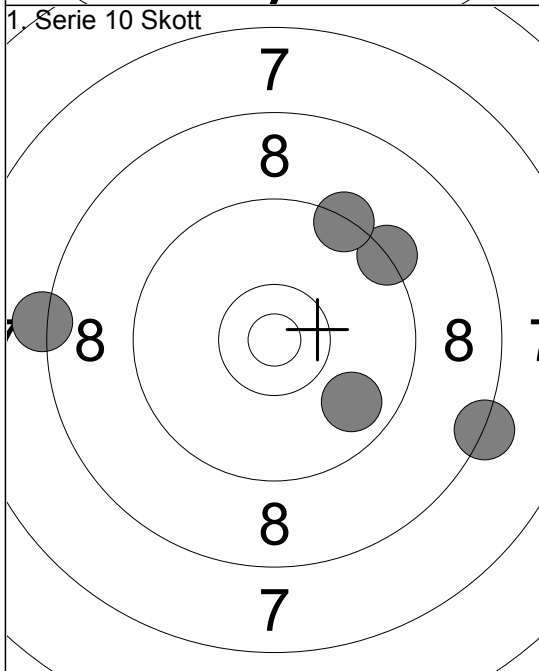

1:	9.3
2:	8.2
3:	9.8
4:	8.3
5:	9.4
Serie 43.0	
Total 211.0	

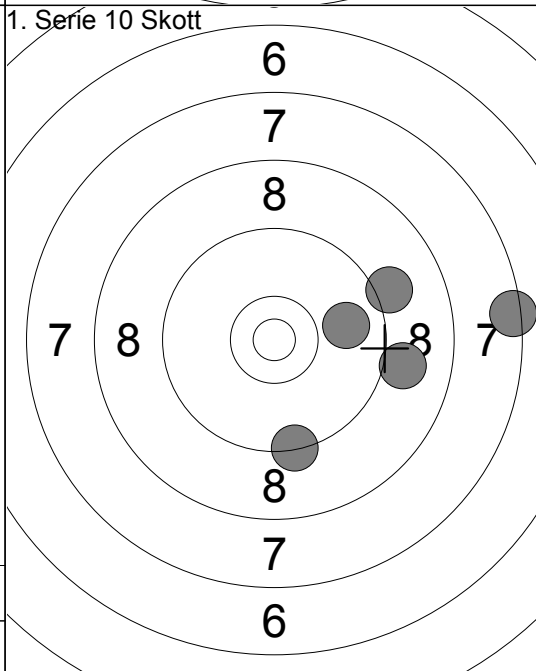

6:	9.3
7:	7.4
8:	9.0
9:	9.1
10:	9.9
Serie 43.0	
Total 254.0	

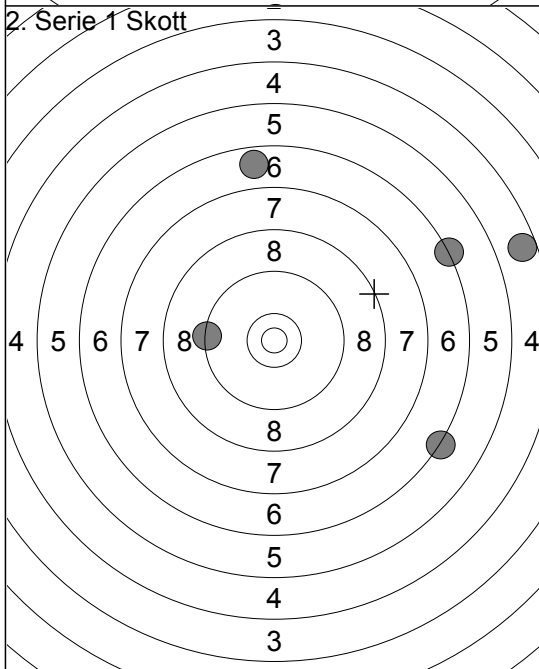

1:	6.7
2:	6.3
3:	9.3
4:	4.6
5:	6.3
Serie 31.0	
Total 285.0	

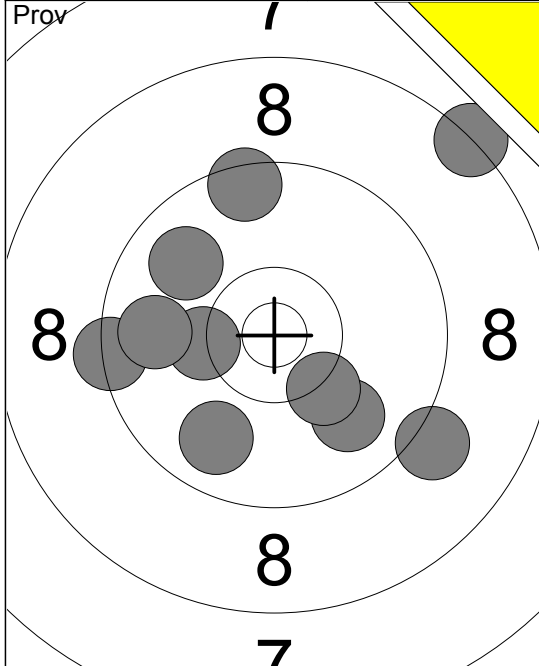

1:	9.4	←
2:	9.1	↘
3:	8.3	↗
4:	9.9	↖
5:	9.8	↙
6:	9.5	↑
7:	9.9	↘
8:	10.3	←
9:	9.8	←
10:	10.3	↘
Serie	91.0	
Total	168.0	

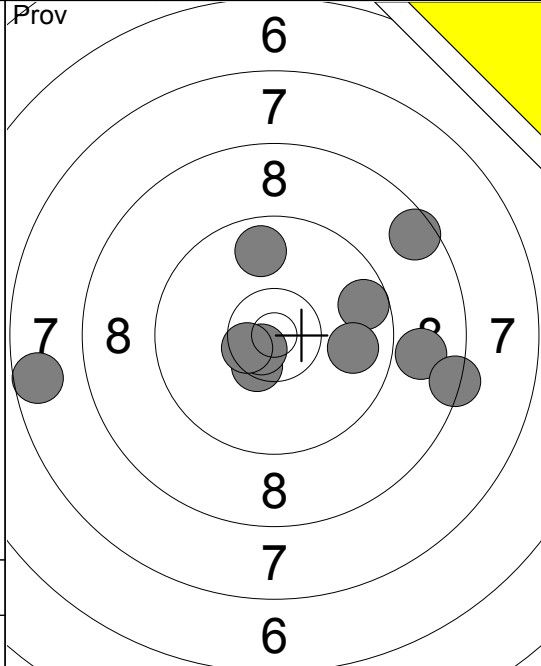

11:	8.9	→
12:	10.5	↘
13:	9.6	→
14:	10.7	↘
15:	9.8	↑
16:	10.5	↘
17:	7.6	←
18:	9.8	→
19:	8.4	→
20:	8.6	↗
Serie	88.0	
Total	168.0	

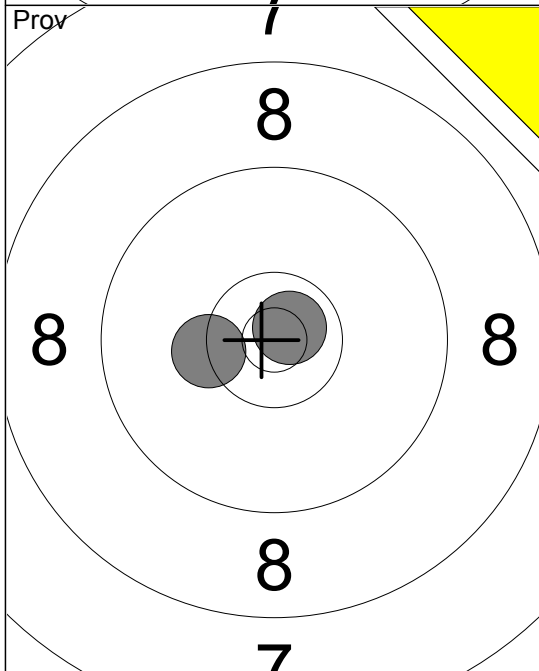

21:	10.8	↗
22:	10.3	↘
Serie	20.0	
Total	168.0	

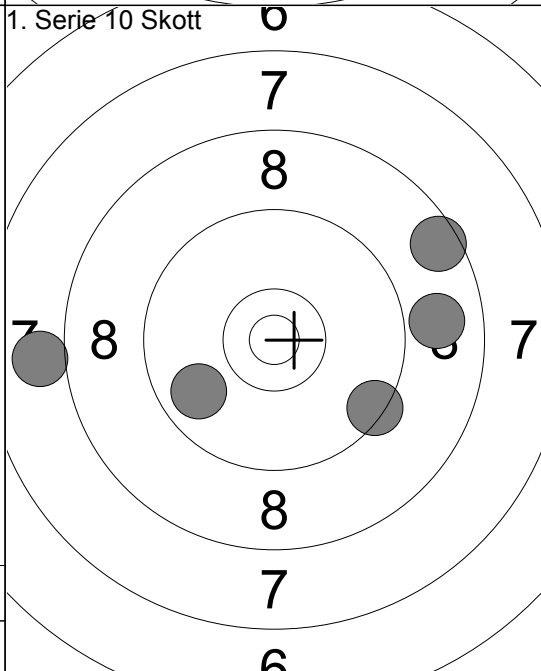

1:	8.5	↗
2:	8.9	→
3:	9.4	↘
4:	9.8	↙
5:	8.0	←
Serie	42.0	
Total	210.0	

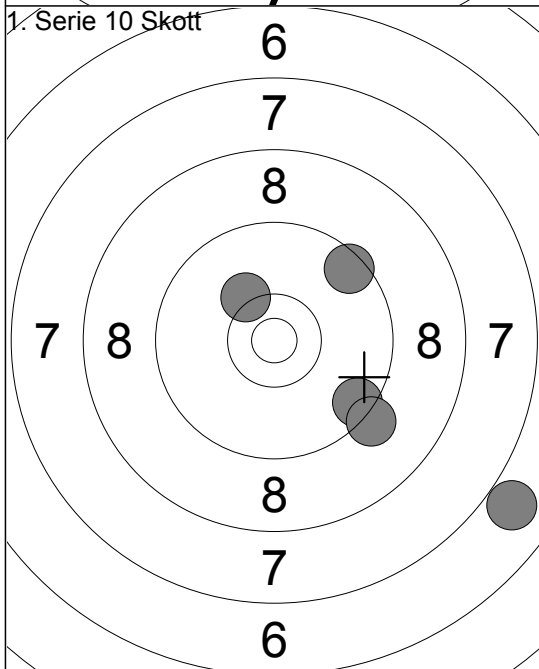

6:	10.2	↖
7:	6.9	↘
8:	9.5	↗
9:	9.5	↘
10:	9.2	↘
Serie	43.0	
Total	253.0	

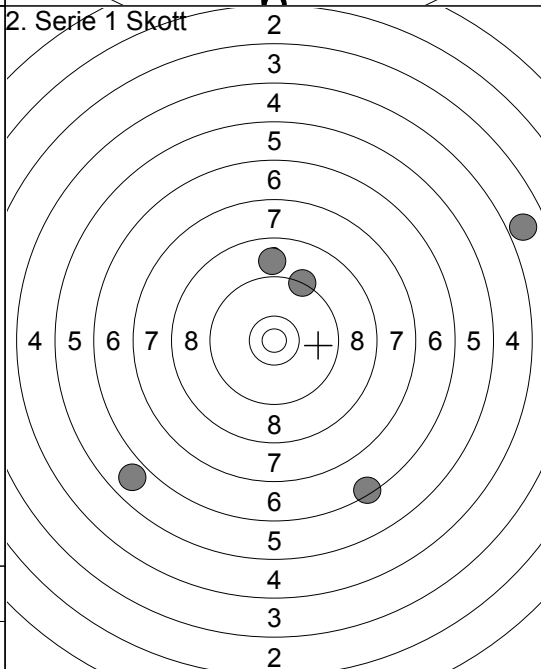

1:	3.9	↗
2:	5.9	↙
3:	9.3	↗
4:	8.9	↑
5:	6.4	↘
Serie	31.0	
Total	284.0	

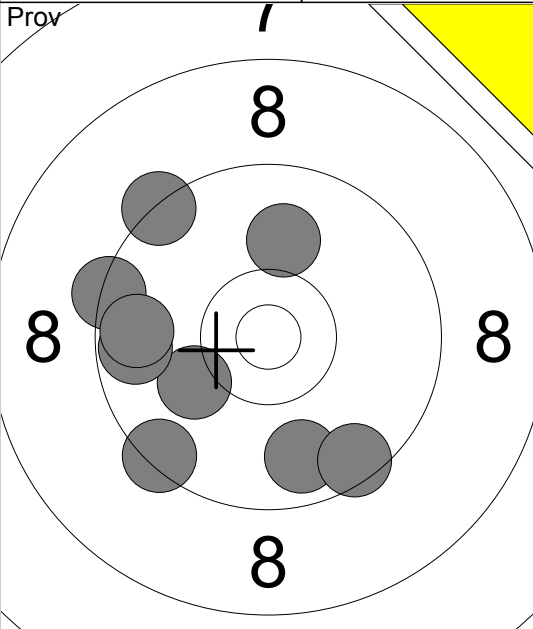
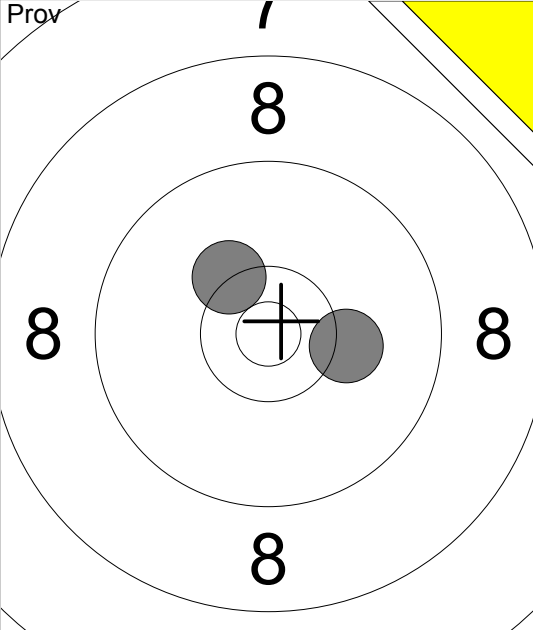
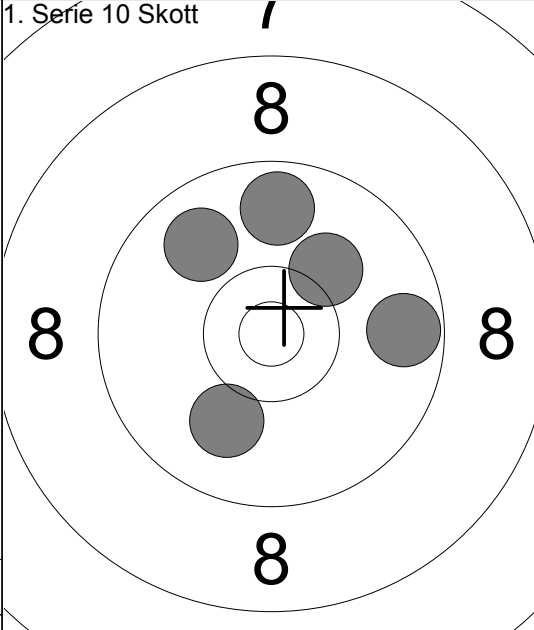
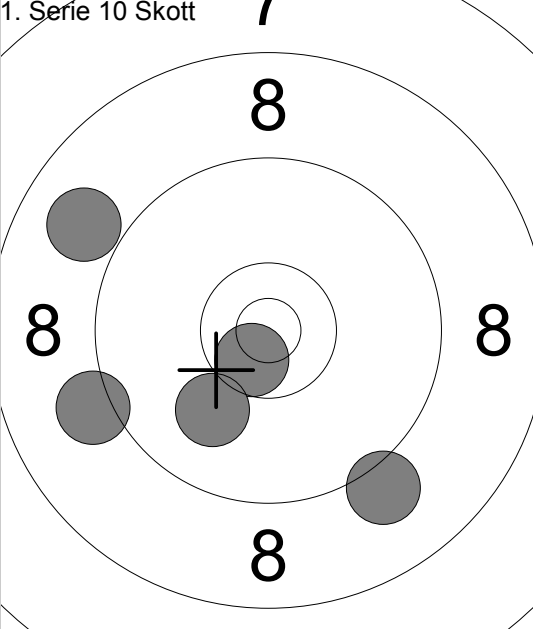
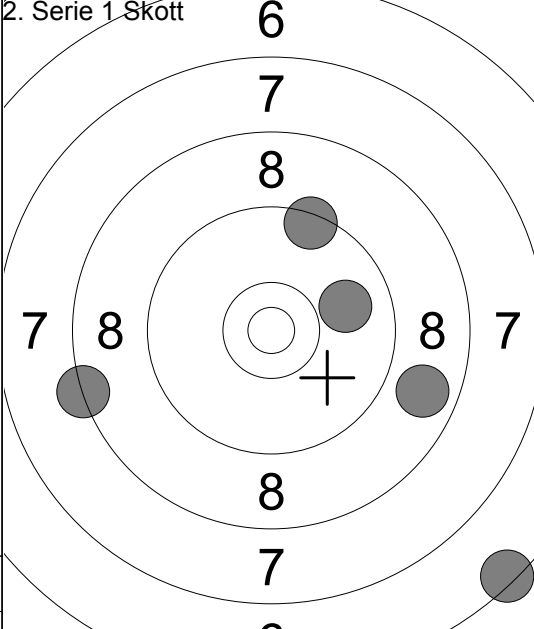
Skjutlag	Tavla	Alf Edin				
7	24	Ale			7, Vet-S	No
50m		Tavelträffen Korthåll 2016		Ramselefors SKF		
12.07.2016		Prov		Prov		
		1: 10.0 ↑ 2: 9.4 ↓ 3: 10.1 ↙ 4: 9.8 ↓ 5: 9.4 ← 7: 9.5 ↓ 8: 9.7 ← 9: 9.7 ← 10: 9.3 ↗		11: 9.8 ↘ 12: 10.6x↓ 13: 10.8x↗ 14: 8.9 ← 15: 9.9 ↗ 16: 10.0 ↙ 17: 9.7 ↓ 18: 9.5 ↗ 19: 10.4x↖ 20: 9.9 →		
		Serie 83.0		Serie 93.0		
		Total 167.0		Total 167.0		
Prov		21: 10.3x ↗ 22: 10.2 →		1. Serie 10 Skott		
		Serie 20.0 Total 167.0				
		Serie 20.0		Serie 47.0		
		Total 167.0		Total 214.0		
1. Serie 10 Skott		6: 9.1 ↓ 7: 10.6x↓ 8: 8.9 ← 9: 10.0 ↓ 10: 9.1 ←		2. Serie 1 Skott		
		Serie 46.0 Total 260.0				
		Serie 46.0		Serie 40.0		
		Total 260.0		Total 300.0		