

1:	9.2 ↗
2:	9.8 ↗
3:	10.2 →
Serie	28.0
Total	0.0

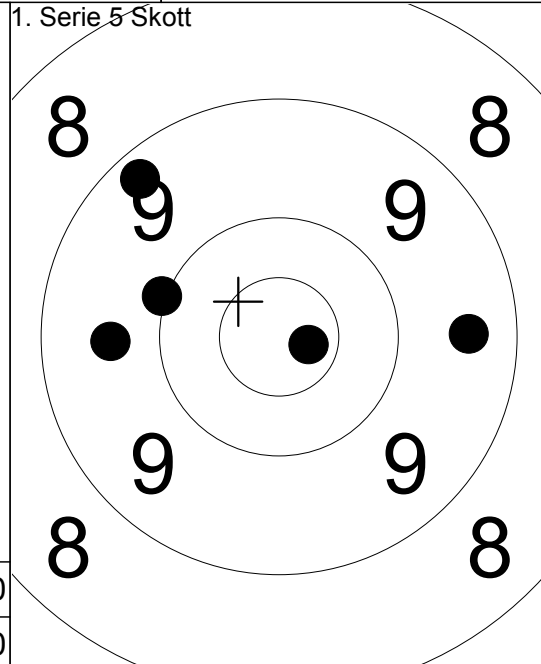

1:	9.4 →
2:	9.3 ↖
3:	9.6 ←
4:	10.0 ↙
5:	10.7x →
Serie	47.0
Total	47.0

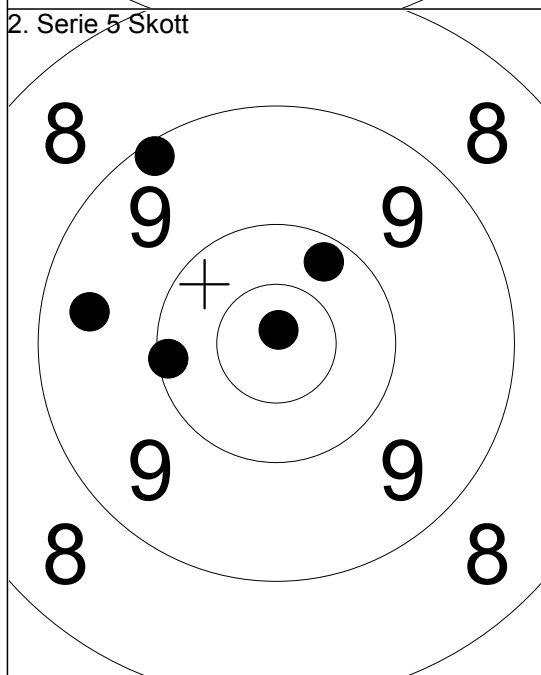

1:	9.2 ↗
2:	10.8x ↗
3:	9.4 ←
4:	10.2 ↗
5:	10.1 ←
Serie	48.0
Total	95.0

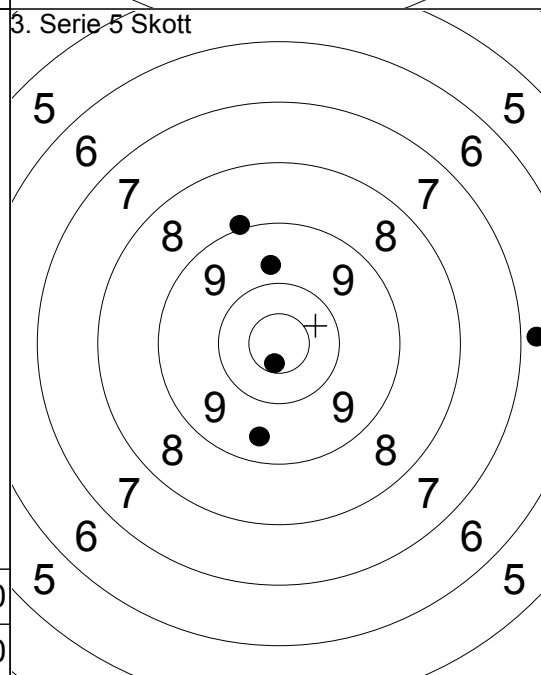

1:	9.7 ↑
2:	9.0 ↗
3:	10.6x ↘
4:	9.5 ↓
5:	6.8 →
Serie	43.0
Total	138.0

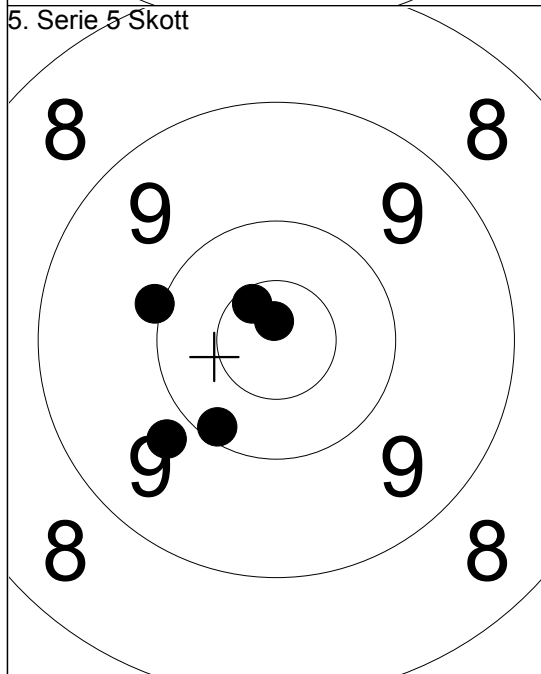

1:	10.8x ↗
2:	9.8 ↘
3:	10.1 ↘
4:	10.0 ↙
5:	10.6x ↘
Serie	49.0
Total	187.0

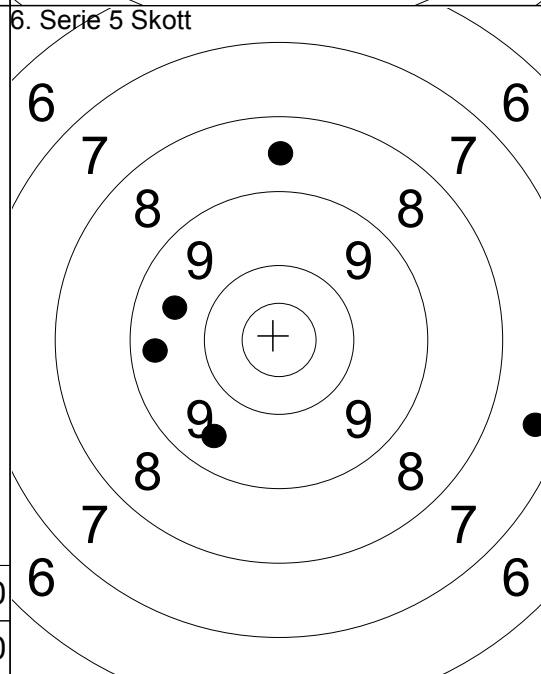

1:	9.5 ↘
2:	9.6 ←
3:	7.4 →
4:	8.5 ↑
5:	9.4 ←
Serie	42.0
Total	229.0

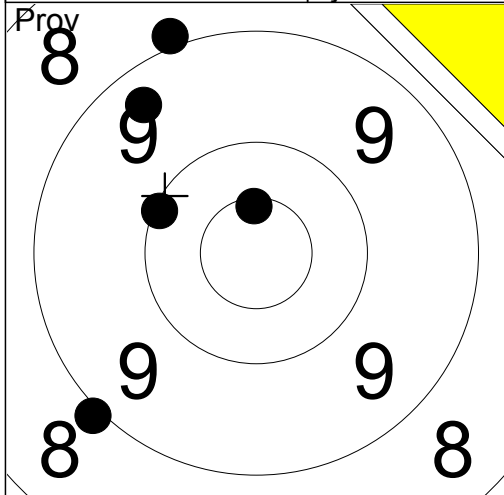

1:	10.6x	↑
2:	8.9	↑
3:	9.4	↑
4:	9.0	↘
5:	10.1	←

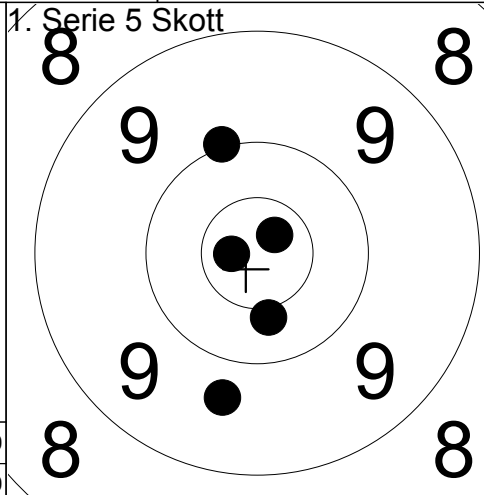

1:	10.4	↓
2:	10.7x	←
3:	10.7x	↗
4:	9.7	↓
5:	10.0	↑

Serie	46.0
Total	0.0

Serie	49.0
Total	49.0

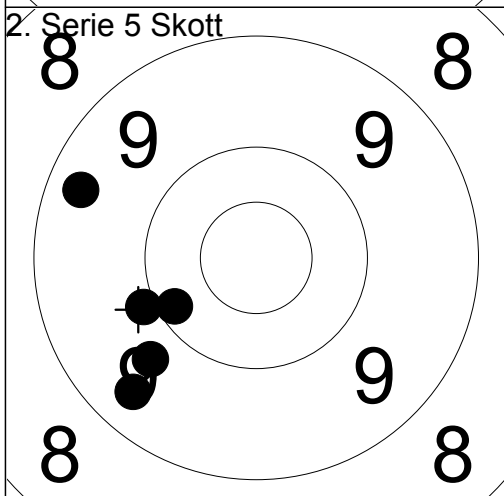

1:	9.7	↙
2:	9.9	←
3:	9.3	←
4:	10.2	←
5:	9.4	↘

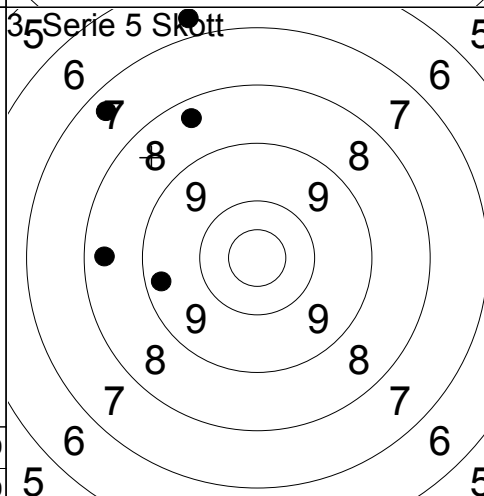

1:	6.7	↑
2:	8.4	←
3:	9.3	←
4:	8.3	↑
5:	7.4	↖

Serie	46.0
Total	95.0

Serie	38.0
Total	133.0

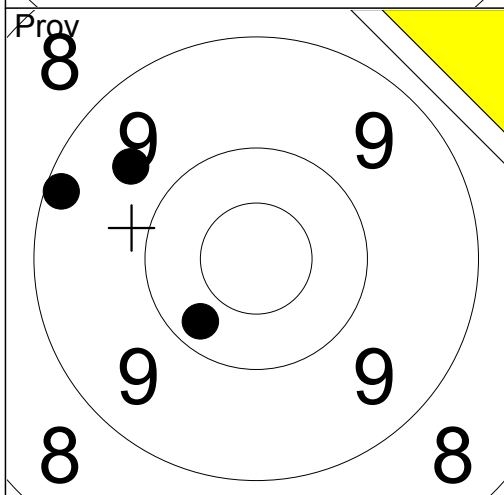

1:	9.6	↘
2:	10.3	↘
3:	9.2	←

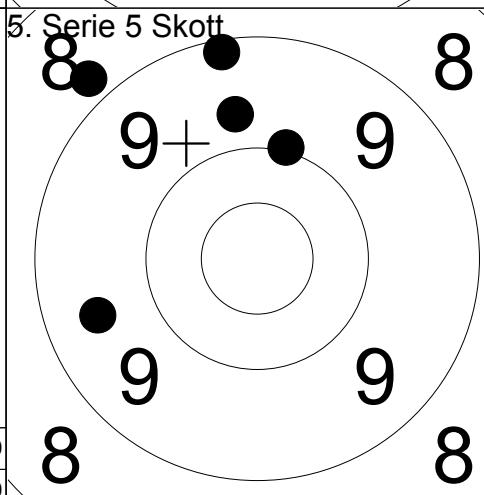

1:	9.1	↑
2:	8.8	↖
3:	10.0	↑
4:	9.7	↑
5:	9.5	←

Serie	28.0
Total	133.0

Serie	45.0
Total	178.0

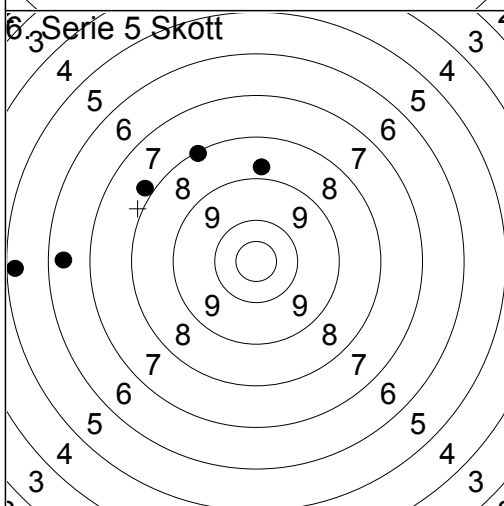

1:	8.1	↑
2:	6.4	←
3:	8.8	↑
4:	7.8	↖
5:	5.2	←

Serie	34.0
Total	212.0

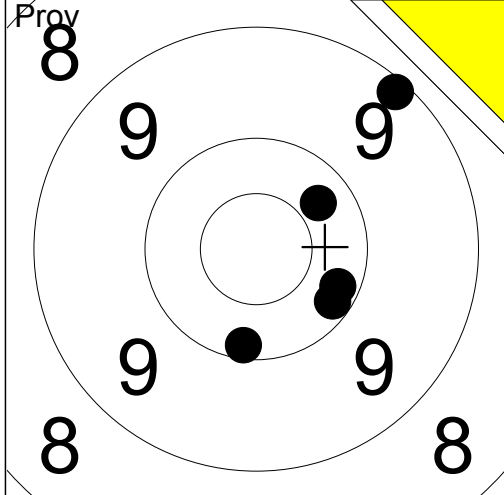

1:	10.2	↘
2:	9.1	↗
3:	10.1	↓
4:	10.3	↗
5:	10.2	↘

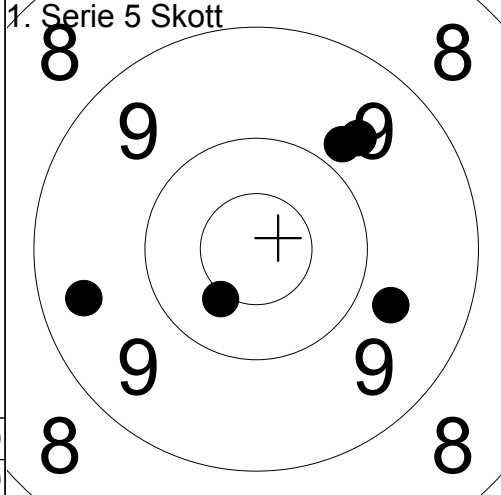

1:	9.7	↗
2:	9.8	↗
3:	9.7	→
4:	10.4x	↓
5:	9.4	←

Serie	49.0
Total	0.0

Serie	46.0
Total	46.0

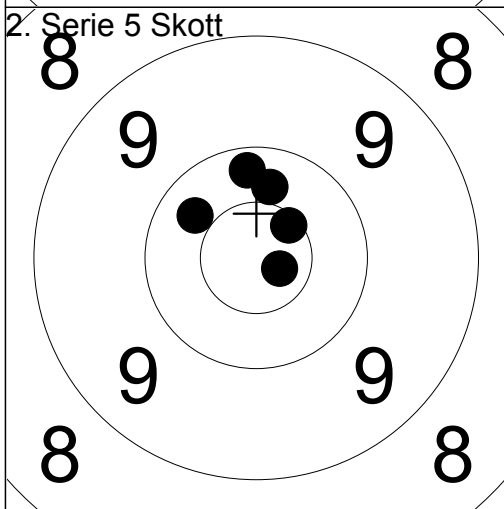

1:	10.3	↖
2:	10.6x	↗
3:	10.3	↑
4:	10.2	↑
5:	10.7x	↘

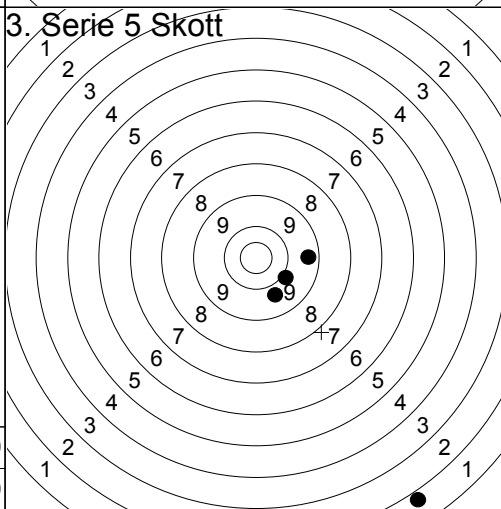

1:	9.7	↓
2:	9.9	↘
3:	9.4	→
4:	1.7	↘
5:	0.0	

Serie	50.0
Total	96.0

Serie	28.0
Total	124.0

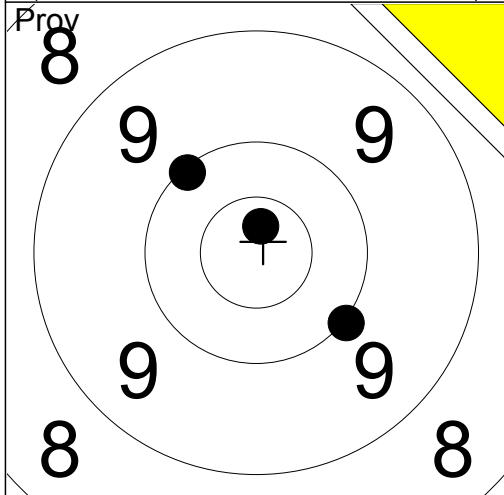

1:	10.7x	↑
2:	10.1	↗
3:	10.0	↘

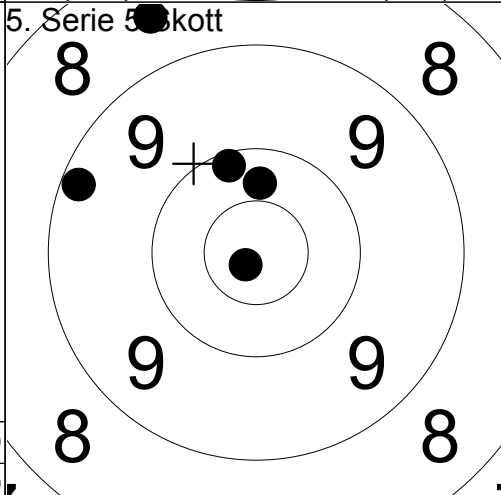

1:	8.5	↗
2:	10.3	↑
3:	9.2	↖
4:	10.1	↑
5:	10.8x	↘

Serie	30.0
Total	124.0

Serie	47.0
Total	171.0

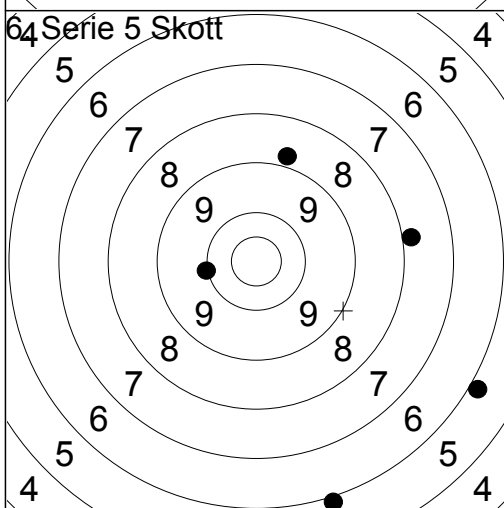

1:	7.8	→
2:	10.0	←
3:	8.8	↑
4:	5.9	↓
5:	5.9	↘

Serie	35.0
Total	206.0

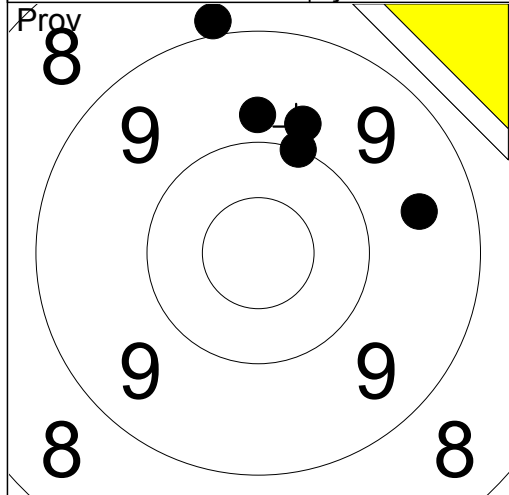

2:	9.8	↑
3:	8.9	↑
4:	10.0	↑
5:	9.5	→
6:	9.8	↑

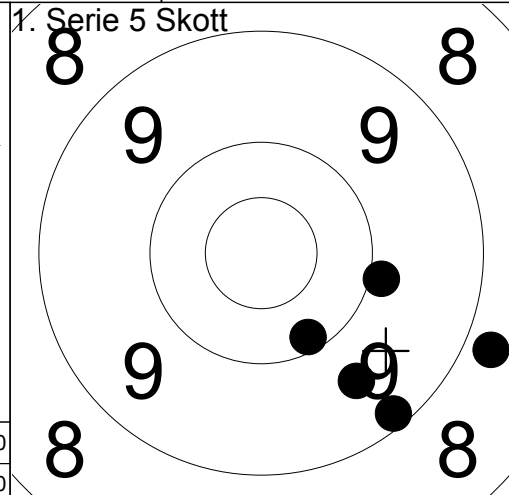

1:	9.9	→
2:	10.2	↘
3:	9.2	↘
4:	8.8	↘
5:	9.6	↘

Serie	45.0
Total	0.0

Serie	45.0
Total	45.0

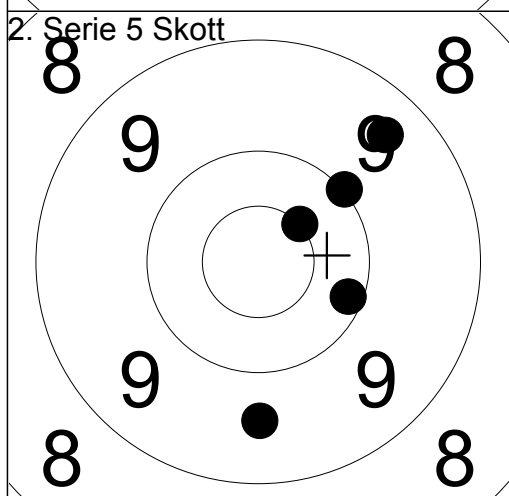

1:	9.4	↗
2:	10.5x	↗
3:	9.6	↓
4:	10.0	↗
5:	10.1	→

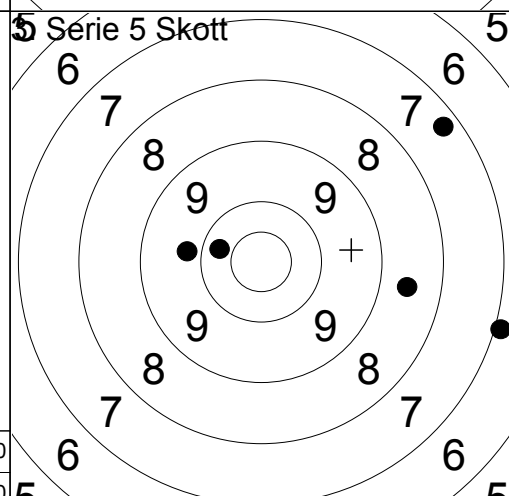

1:	9.8	←
2:	10.3	←
3:	8.6	→
4:	6.9	→
5:	7.3	↗

Serie	48.0
Total	93.0

Serie	40.0
Total	133.0

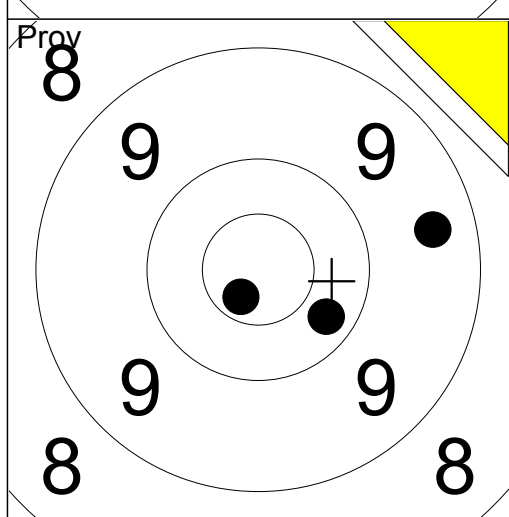

1:	9.4	→
2:	10.7x	↘
3:	10.3	↘

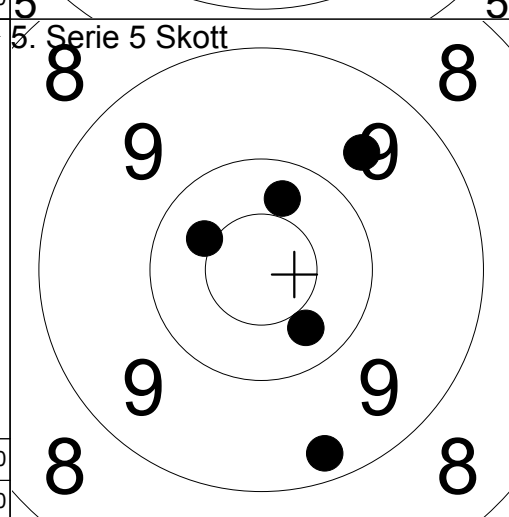

1:	9.6	↗
2:	10.4x	↗
3:	10.3	↘
4:	10.3	↑
5:	9.3	↘

Serie	29.0
Total	133.0

Serie	48.0
Total	181.0

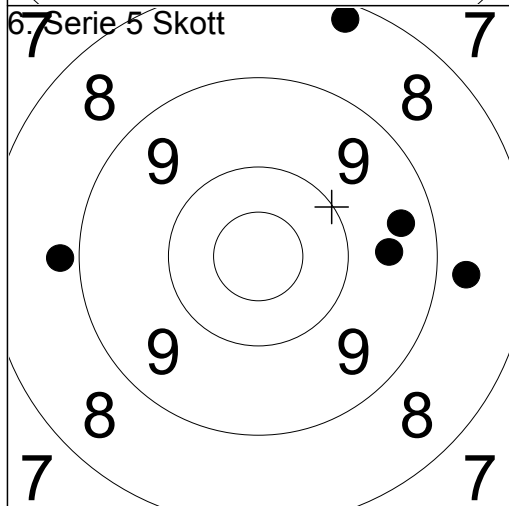

1:	8.8	←
2:	8.7	→
3:	9.6	→
4:	8.2	↑
5:	9.4	→

Serie	42.0
Total	223.0

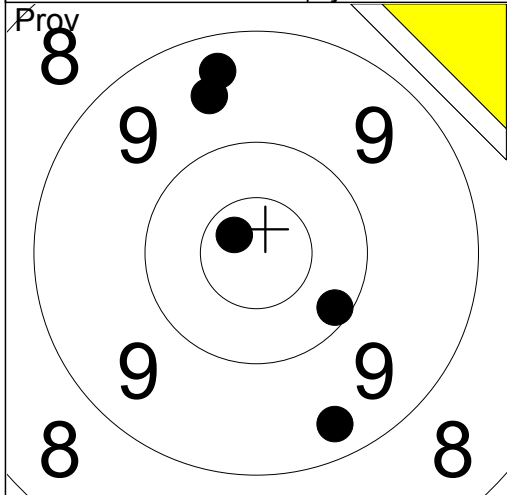

1:	9.6	↗
2:	9.4	↗
3:	10.7x	↗
4:	10.2	↘
5:	9.3	↘
Serie		47.0
Total		0.0

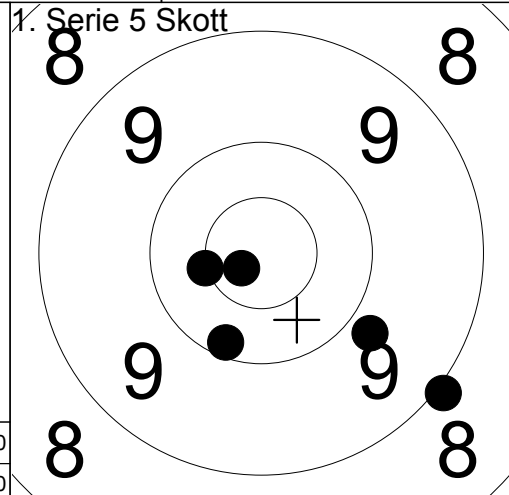

1:	10.1	↘
2:	9.8	↘
3:	10.5x	←
4:	10.7x	↘
5:	9.0	↘
Serie		48.0
Total		48.0

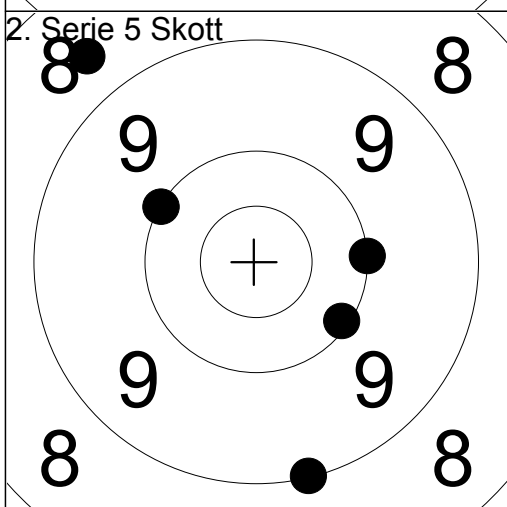

1:	9.0	↘
2:	10.1	↘
3:	10.0	↗
4:	8.6	↗
5:	10.0	→
Serie		47.0
Total		95.0

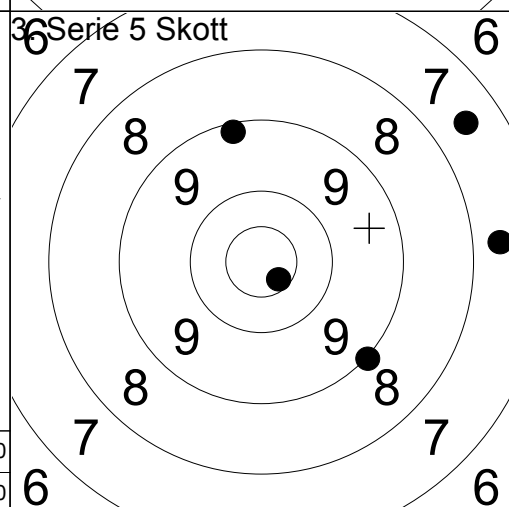

1:	10.6x	↘
2:	9.2	↗
3:	9.0	↘
4:	7.7	→
5:	7.5	↗
Serie		42.0
Total		137.0

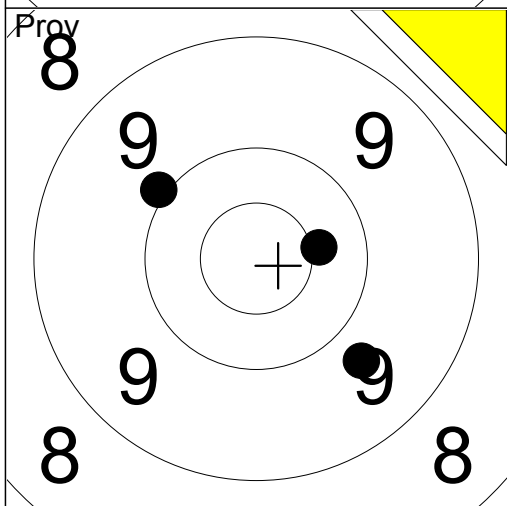

1:	10.0	↗
2:	10.4x	→
3:	9.7	↘
Serie		29.0
Total		137.0

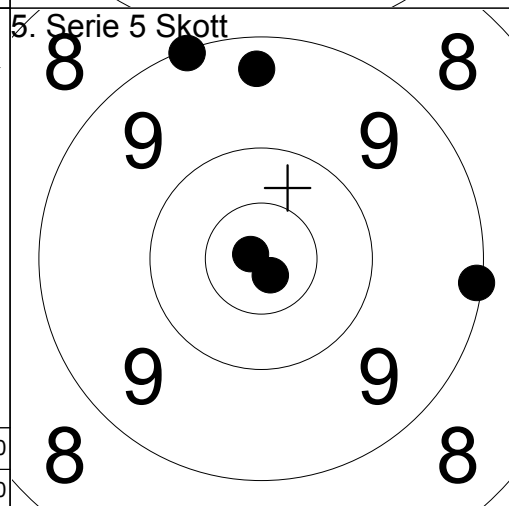

1:	9.1	→
2:	9.3	↗
3:	9.1	↗
4:	10.9x	↗
5:	10.8x	↘
Serie		47.0
Total		184.0

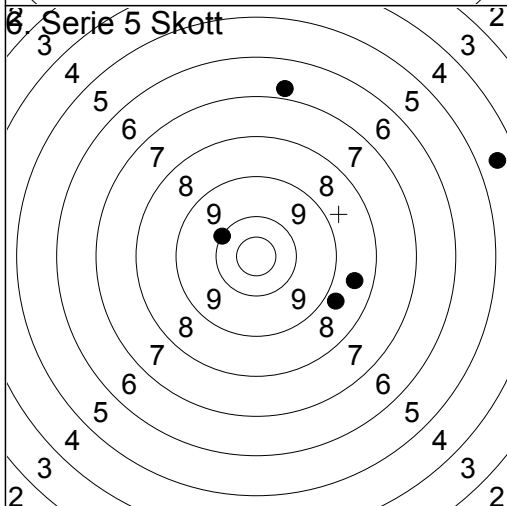

1:	10.0	↗
2:	8.5	↘
3:	8.7	↘
4:	6.8	↗
5:	4.5	→
Serie		36.0
Total		220.0

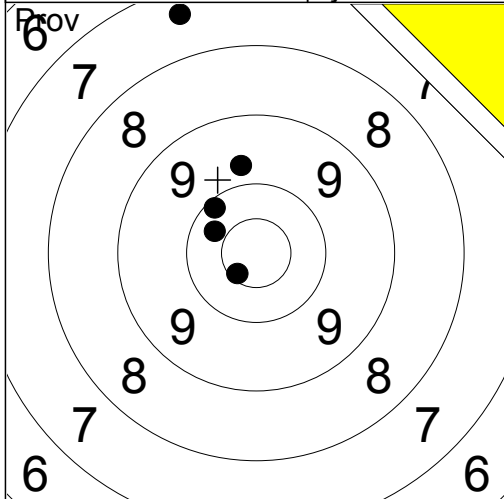

- 1: 7.4 ↗
- 2: 10.1 ↗
- 3: 10.3 ↖
- 4: 9.8 ↗
- 5: 10.6x ↘

Serie 46.0
Total 0.0

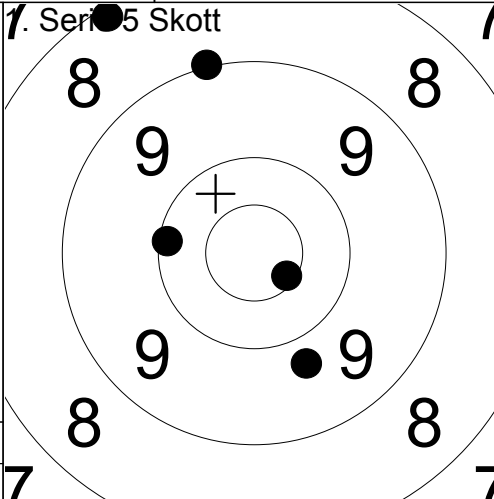

- 1: 8.1 ↗
- 2: 9.0 ↗
- 3: 9.8 ↘
- 4: 10.6x ↘
- 5: 10.1 ←

Serie 46.0
Total 46.0

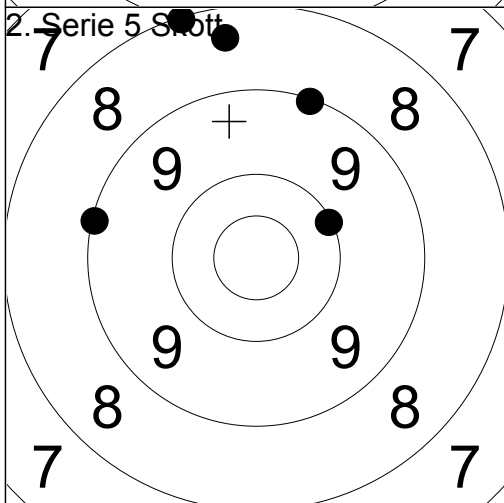

- 1: 9.1 ←
- 2: 9.1 ↗
- 3: 10.1 ↗
- 4: 8.4 ↗
- 5: 8.1 ↗

Serie 44.0
Total 90.0

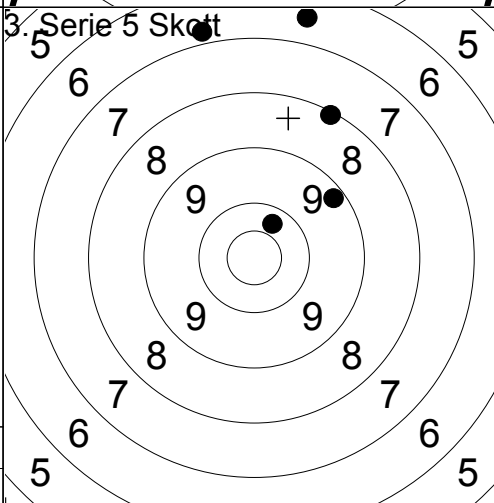

- 1: 6.8 ↗
- 2: 10.3 ↗
- 3: 8.1 ↗
- 4: 9.2 ↗
- 5: 6.6 ↗

Serie 39.0
Total 129.0

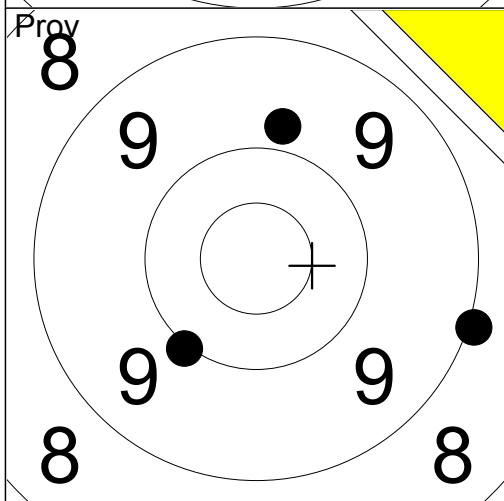

- 1: 9.8 ↗
- 2: 10.0 ↘
- 3: 9.0 →

Serie 28.0
Total 129.0

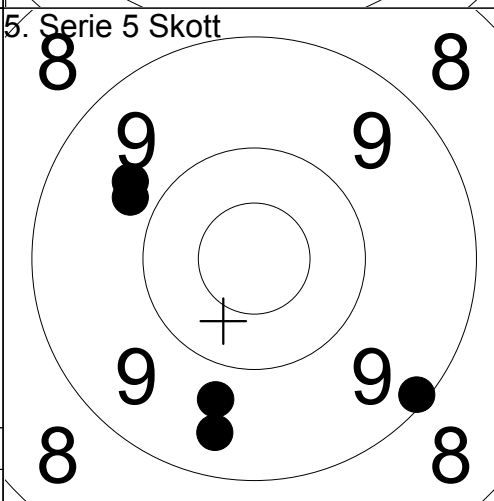

- 1: 9.8 ↖
- 2: 9.7 ↗
- 3: 9.4 ↘
- 4: 9.7 ↘
- 5: 9.1 ↘

Serie 45.0
Total 174.0

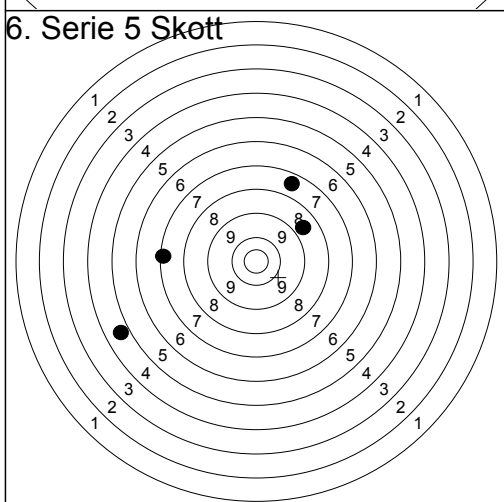

- 1: 7.5 ↗
- 2: 4.7 ↖
- 3: 8.6 ↗
- 4: 7.2 ←
- 5: 0.0 ↘

Serie 26.0
Total 200.0

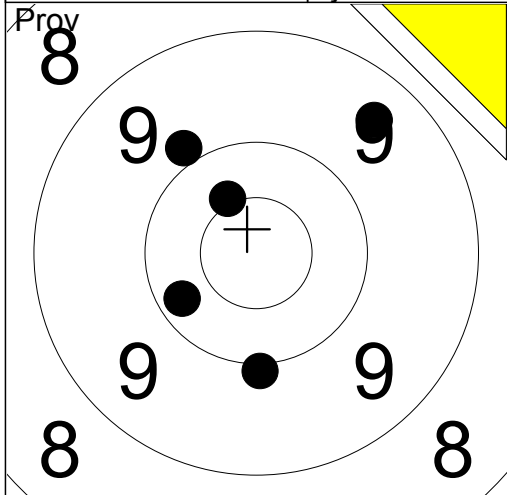

1:	9.9	↖
2:	10.0	↓
3:	10.2	↙
4:	9.4	↗
5:	10.4x	↗

Serie	48.0
Total	0.0

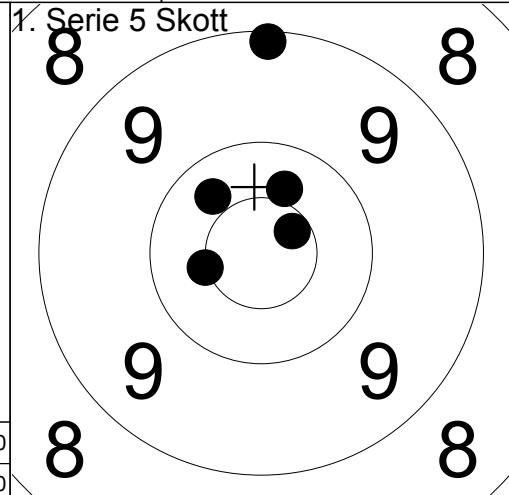

1:	9.1	↑
2:	10.3	↖
3:	10.4	↑
4:	10.6x	↗
5:	10.5x	←

Serie	49.0
Total	49.0

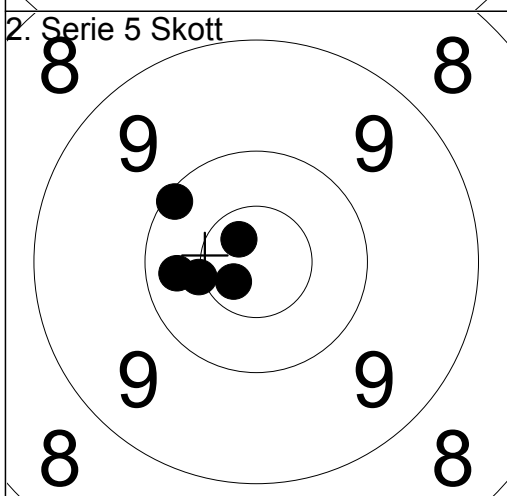

1:	10.7x	↖
2:	10.5x	←
3:	10.1	↗
4:	10.7x	↙
5:	10.3	←

Serie	50.0
Total	99.0

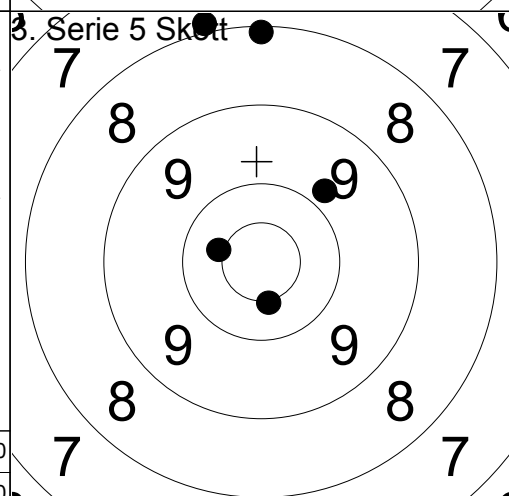

1:	9.8	↗
2:	10.4x	←
3:	10.5x	↓
4:	8.1	↑
5:	7.9	↑

Serie	44.0
Total	143.0

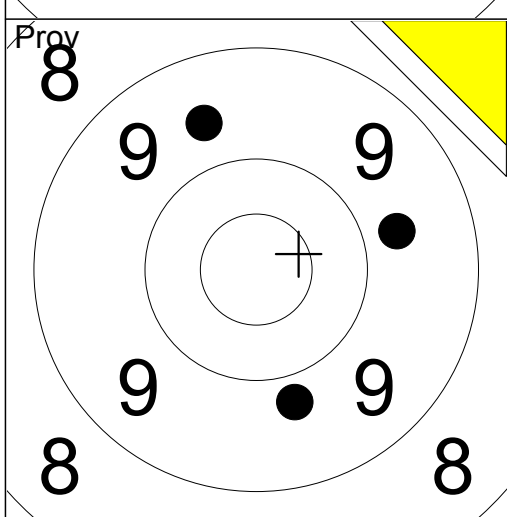

1:	9.8	↓
2:	9.6	↗
3:	9.7	→

Serie	27.0
Total	143.0

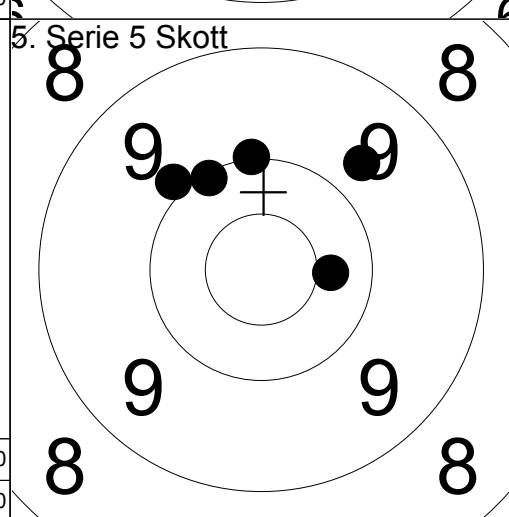

1:	10.4	→
2:	9.9	↖
3:	10.0	↑
4:	10.1	↖
5:	9.7	↗

Serie	48.0
Total	191.0

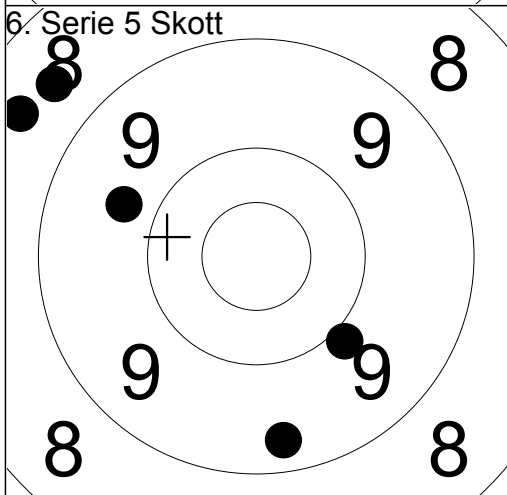

1:	9.9	↓
2:	9.7	↖
3:	8.6	↗
4:	8.5	↗
5:	9.3	↓

Serie	43.0
Total	234.0

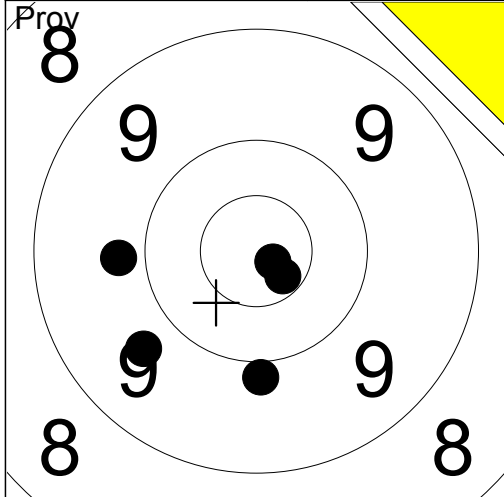

1:	10.8x	↘
2:	9.7	↙
3:	9.9	↓
4:	9.8	←
5:	10.6x	↘
Serie		47.0
Total		0.0

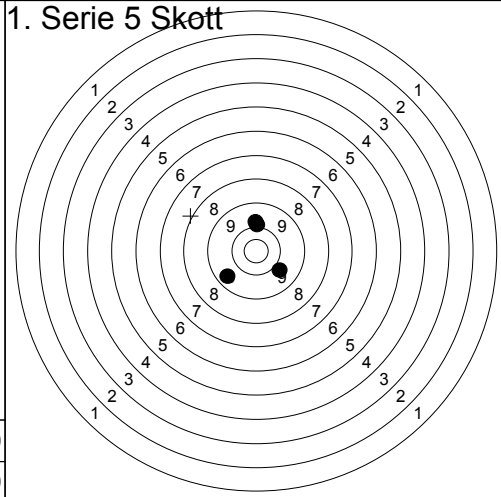

1:	9.8	↑
2:	9.5	↙
3:	9.8	↘
4:	9.9	↑
5:	0.0	↖
Serie		36.0
Total		36.0

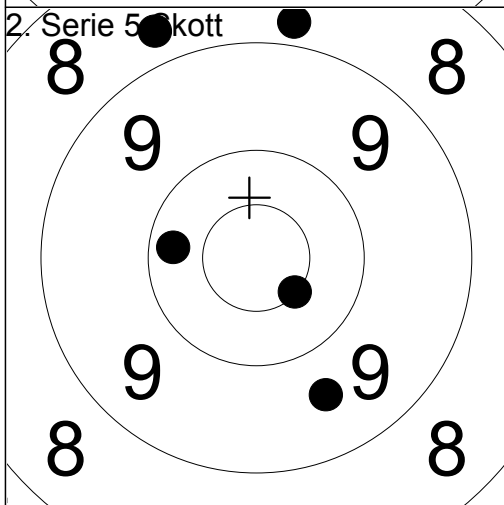

1:	8.7	↗
2:	10.5x	↘
3:	9.6	↘
4:	10.2	←
5:	8.8	↑
Serie		45.0
Total		81.0

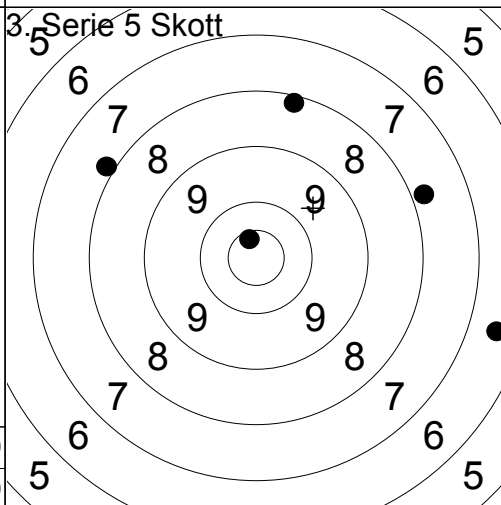

1:	7.9	↖
2:	8.2	↑
3:	7.8	→
4:	6.5	→
5:	10.6x	↑
Serie		38.0
Total		119.0

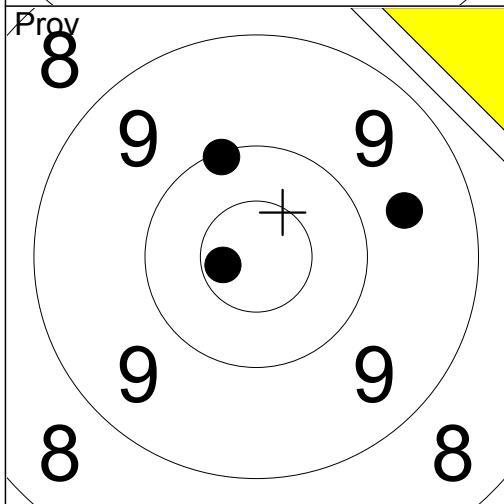

1:	10.1	↑
2:	9.6	→
3:	10.7x	←
Serie		29.0
Total		119.0

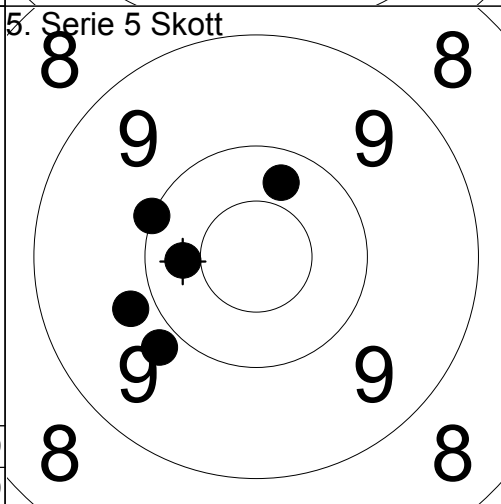

1:	10.3	←
2:	9.8	↙
3:	10.3	↑
4:	10.0	↖
5:	9.8	←
Serie		48.0
Total		167.0

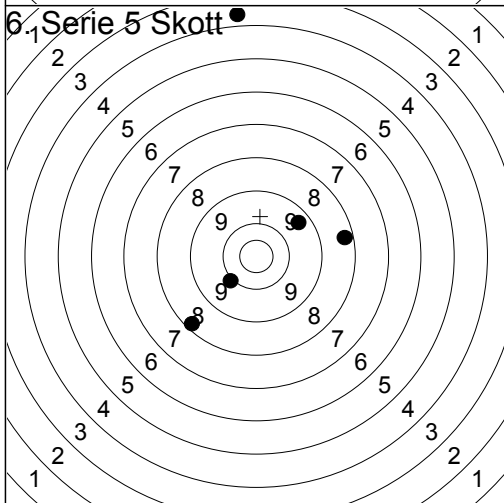

1:	10.0	↙
2:	9.4	↗
3:	8.3	→
4:	3.7	↑
5:	8.2	↘
Serie		38.0
Total		205.0

Serie		36.0
Total		36.0

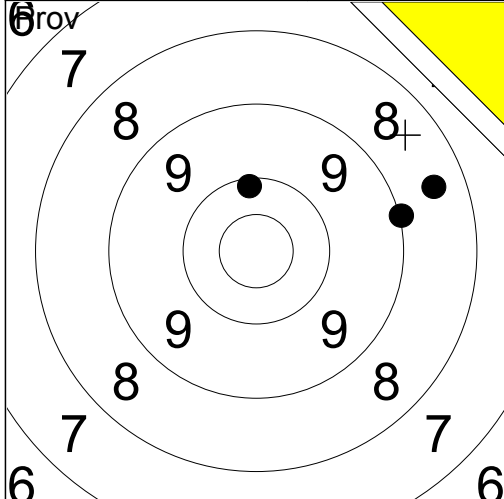

1:	6.6	↗
2:	8.5	→
3:	9.0	→
4:	7.3	↗
5:	10.1	↑
Serie	40.0	
Total	0.0	

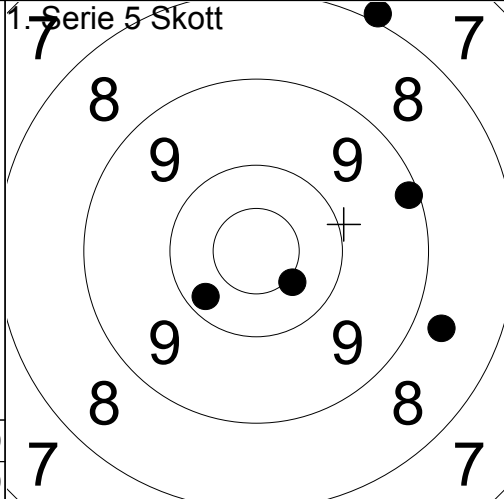

1:	7.9	↗
2:	10.4x	↘
3:	8.7	→
4:	9.1	→
5:	10.2	↙
Serie	44.0	
Total	44.0	

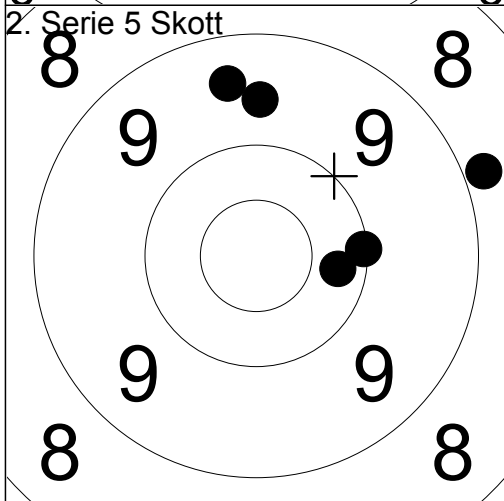

1:	9.6	↑
2:	9.5	↑
3:	10.1	→
4:	8.8	→
5:	10.3	→
Serie	46.0	
Total	90.0	

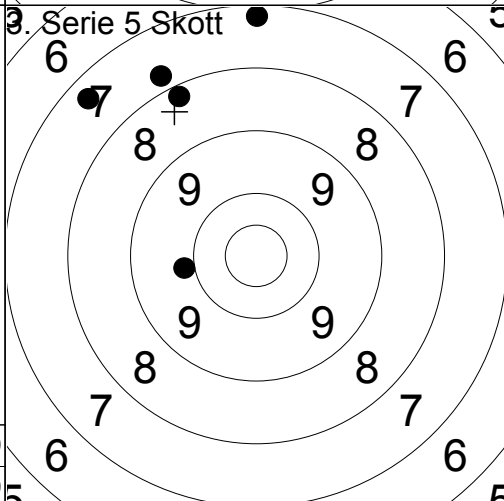

1:	7.8	↗
2:	7.2	↑
3:	8.2	↗
4:	7.4	↗
5:	9.9	←
Serie	38.0	
Total	128.0	

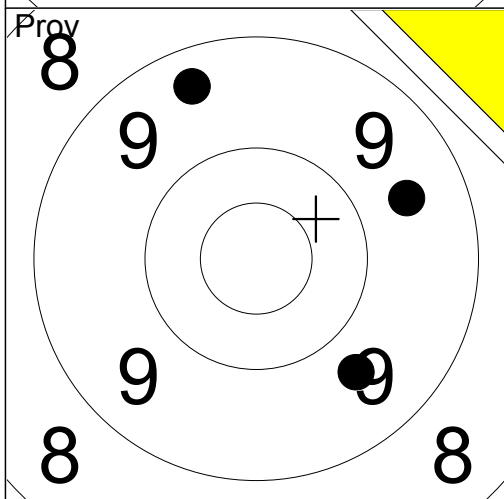

1:	9.4	↑
2:	9.7	↘
3:	9.6	→
Serie	27.0	
Total	128.0	

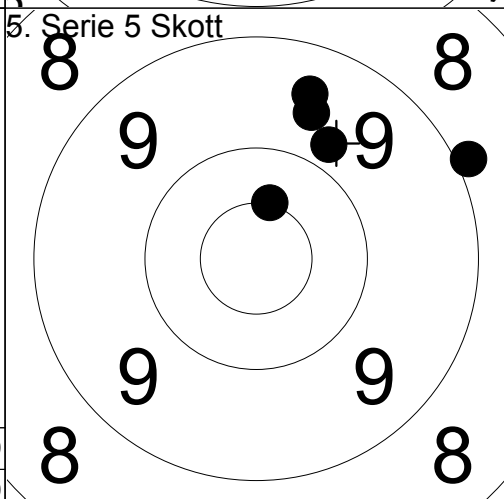

1:	9.6	↑
2:	8.9	→
3:	9.5	↑
4:	9.8	↑
5:	10.5x	↑
Serie	45.0	
Total	173.0	

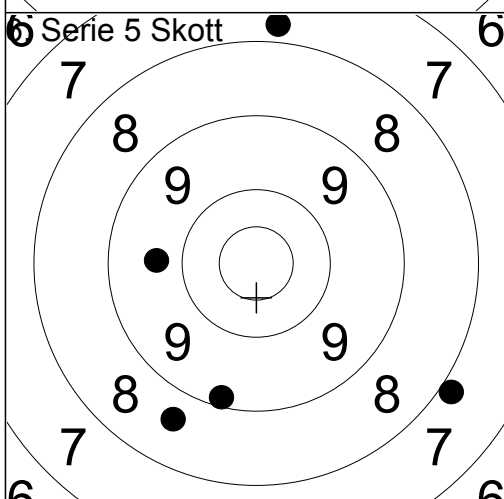

1:	7.8	↑
2:	8.6	↘
3:	9.7	←
4:	7.9	↘
5:	9.2	↘
Serie	40.0	
Total	213.0	

1:	7.9	↗
2:	10.4x	↘
3:	8.7	→
4:	9.1	→
5:	10.2	↙
Serie	44.0	
Total	44.0	

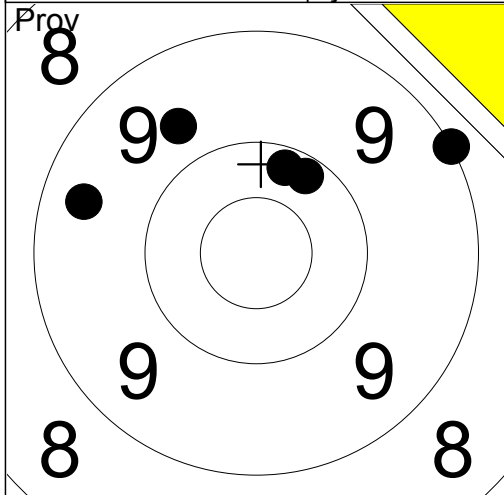

- 1: 9.4 ←
- 2: 9.7 ↗
- 3: 9.0 ↗
- 4: 10.2 ↗
- 5: 10.2 ↑

Serie	47.0
Total	0.0

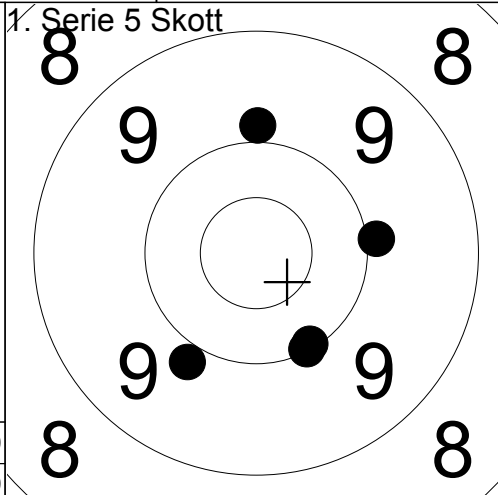

- 1: 9.9 →
- 2: 10.0 ↓
- 3: 9.9 ↑
- 4: 10.1 ↓
- 5: 9.9 ↓

Serie	47.0
Total	47.0

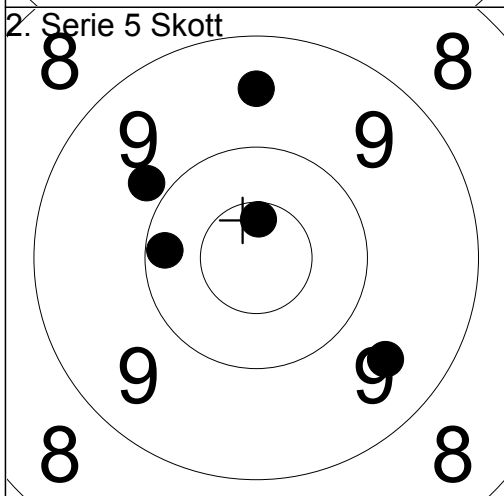

- 1: 9.8 ↖
- 2: 9.5 ↑
- 3: 10.2 ←
- 4: 10.6x ↑
- 5: 9.6 ↘

Serie	47.0
Total	94.0

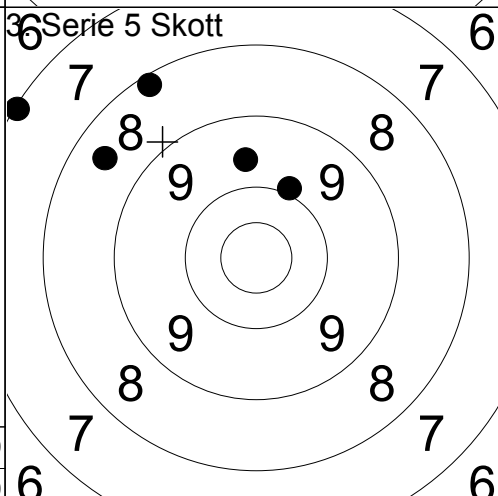

- 1: 9.6 ↑
- 2: 8.5 ↖
- 3: 9.9 ↑
- 4: 8.2 ↗
- 5: 7.1 ↖

Serie	41.0
Total	135.0

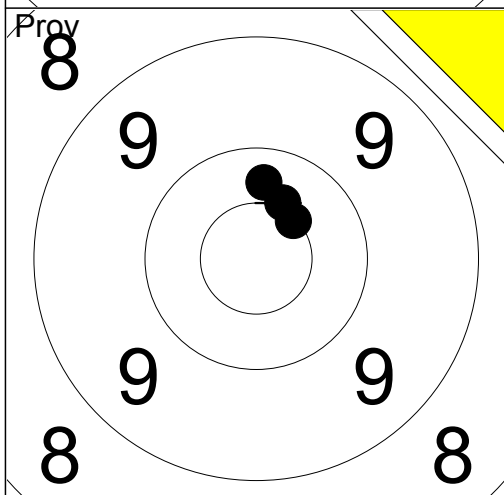

- 1: 10.4x ↗
- 2: 10.5x ↗
- 3: 10.3 ↑

Serie	30.0
Total	135.0

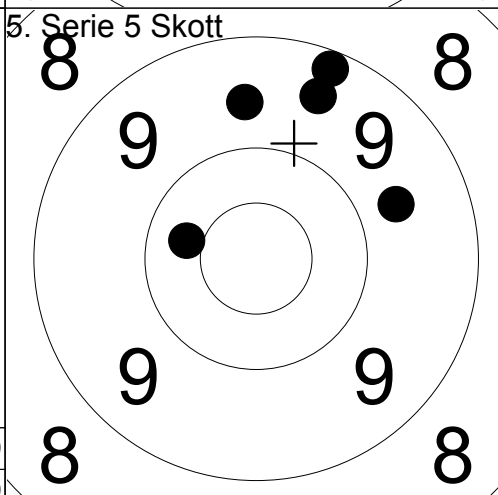

- 1: 10.3 ←
- 2: 9.5 ↑
- 3: 9.6 ↑
- 4: 9.7 →
- 5: 9.2 ↑

Serie	46.0
Total	181.0

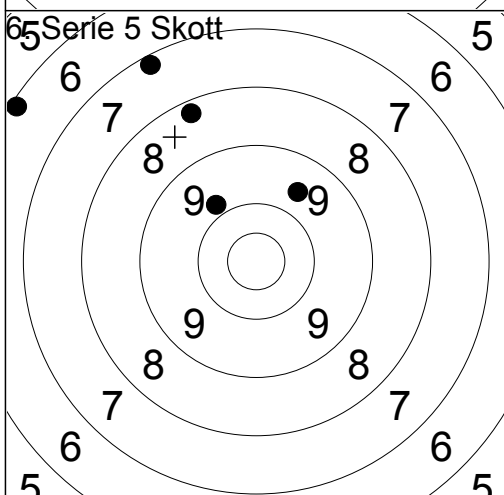

- 1: 9.6 ↗
- 2: 8.2 ↑
- 3: 7.2 ↗
- 4: 6.1 ↗
- 5: 9.8 ↗

Serie	39.0
Total	220.0

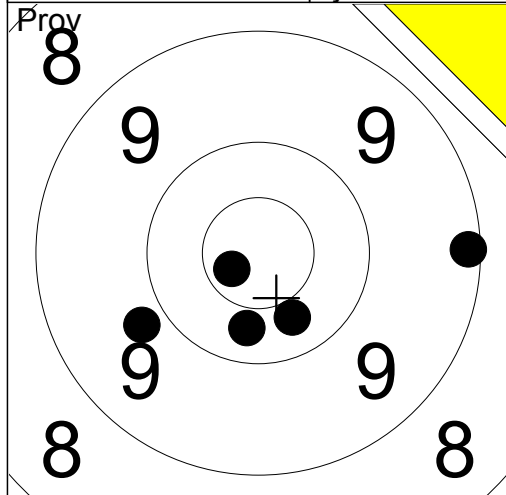

1:	9.1	→
2:	10.7x	↙
3:	10.3	↘
4:	10.3	↓
5:	9.8	↙

Serie	48.0
Total	0.0

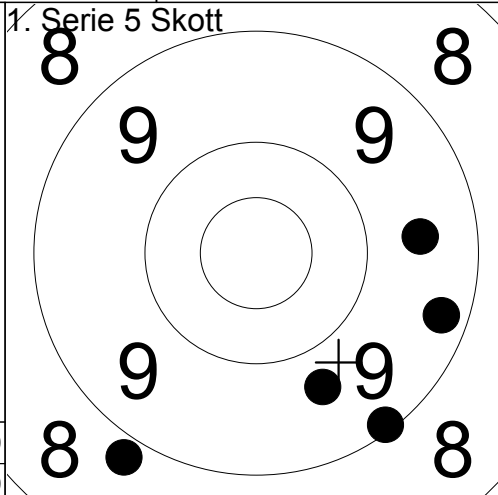

1:	9.3	→
2:	9.1	↘
3:	9.5	→
4:	9.7	↘
5:	8.8	↘

Serie	44.0
Total	44.0

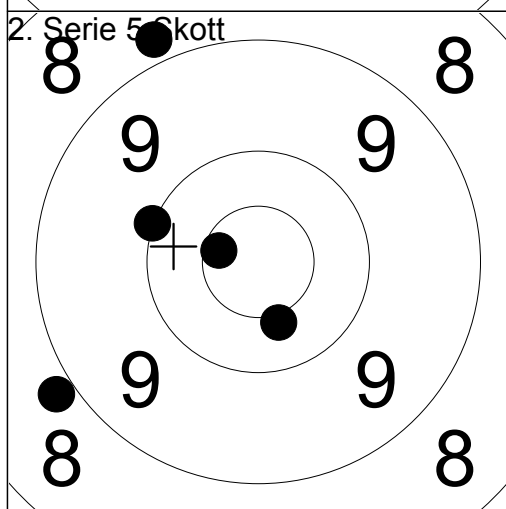

1:	8.8	↗
2:	10.0	↖
3:	10.6x	↖
4:	8.9	↘
5:	10.4x	↘

Serie	46.0
Total	90.0

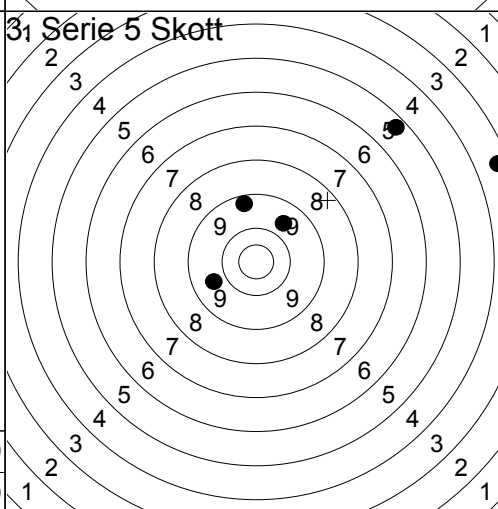

1:	9.7	↖
2:	5.3	↗
3:	9.3	↑
4:	9.6	↗
5:	3.4	→

Serie	35.0
Total	125.0

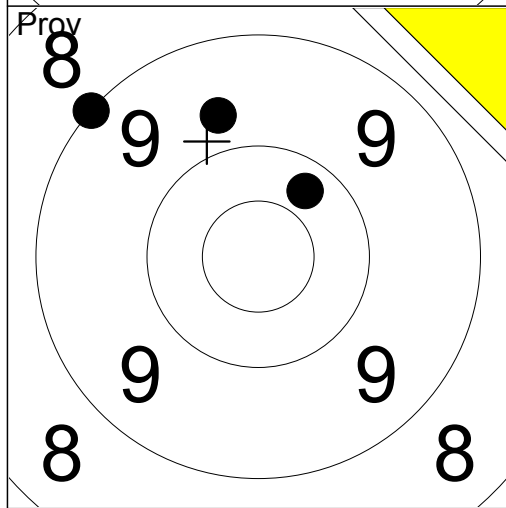

1:	10.3	↗
2:	9.7	↗
3:	9.0	↗

Serie	28.0
Total	125.0

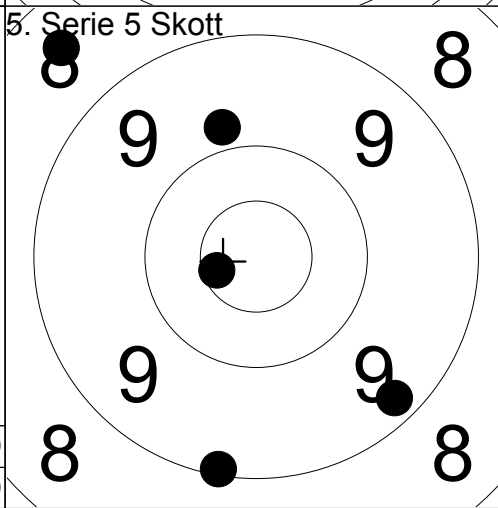

1:	8.5	↗
2:	10.6x	↖
3:	9.3	↘
4:	9.8	↗
5:	9.1	↘

Serie	45.0
Total	170.0

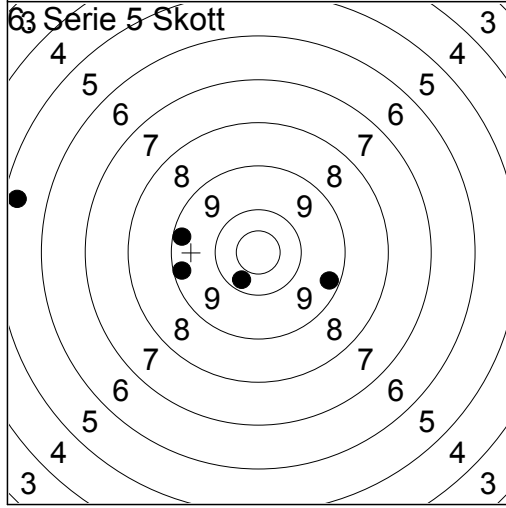

1:	9.3	→
2:	9.2	↖
3:	10.3	↘
4:	5.3	↖
5:	9.2	↖

Serie	42.0
Total	212.0

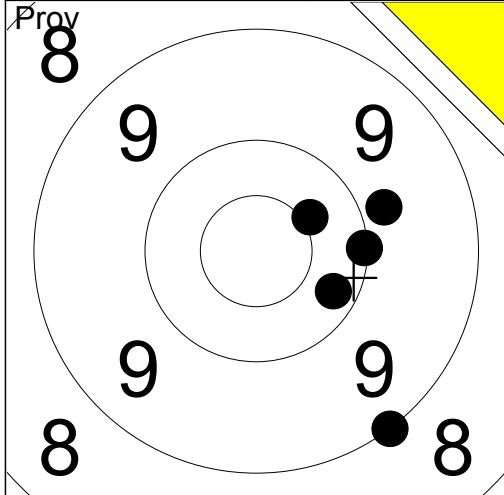

1:	9.8	→
2:	10.1	→
3:	10.2	↘
4:	10.4x	→
5:	9.0	↘

Serie	48.0
Total	0.0

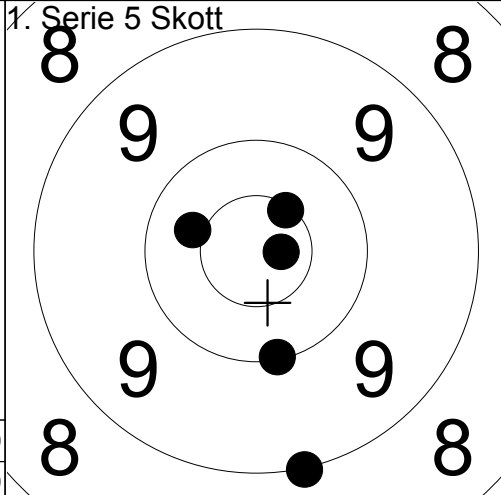

1:	9.0	↘
2:	10.0	↘
3:	10.7x	→
4:	10.4	←
5:	10.5x	↗

Serie	49.0
Total	49.0

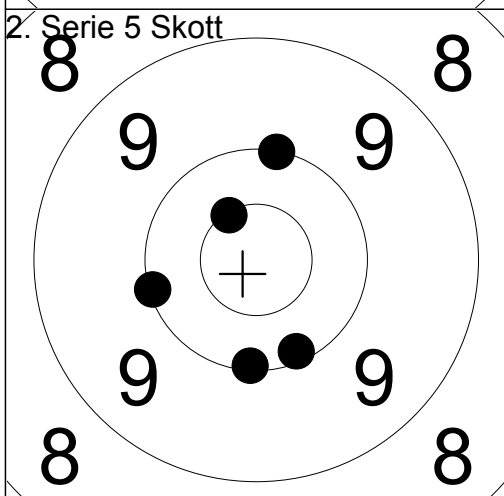

1:	10.1	↘
2:	10.1	←
3:	10.1	↘
4:	10.0	↑
5:	10.5x	↗

Serie	50.0
Total	99.0

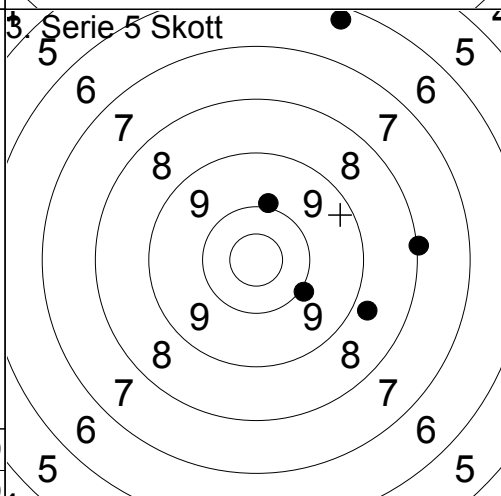

1:	8.8	→
2:	10.0	↘
3:	9.9	↑
4:	6.3	↑
5:	8.0	→

Serie	41.0
Total	140.0

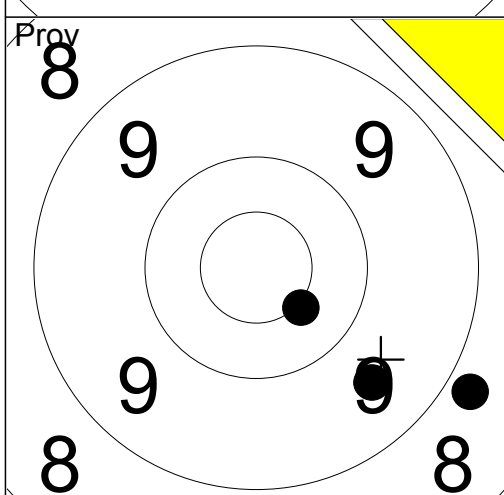

1:	10.5x	↘
2:	9.6	↘
3:	8.8	↘

Serie	27.0
Total	140.0

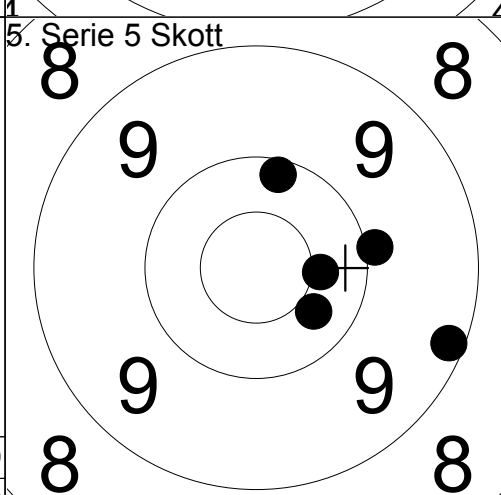

1:	10.2	↑
2:	10.3	↘
3:	9.2	↘
4:	9.9	→
5:	10.4	→

Serie	48.0
Total	188.0

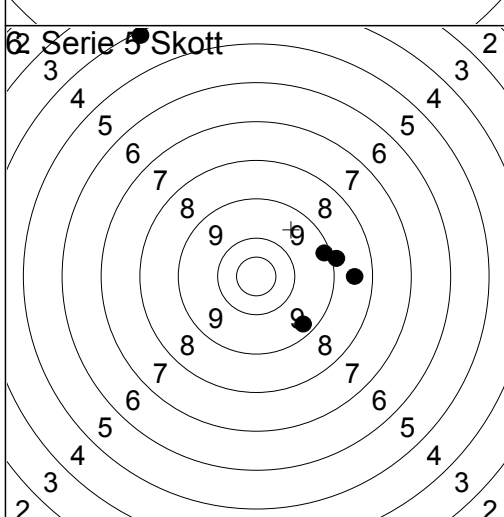

1:	9.3	↘
2:	8.9	→
3:	9.2	→
4:	8.5	→
5:	4.1	↗

Serie	38.0
Total	226.0

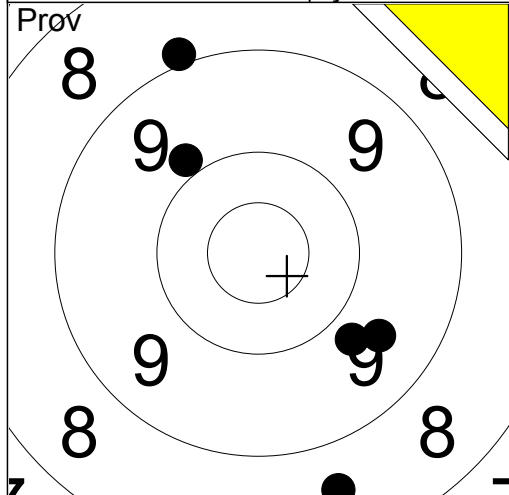

1:	8.6	↘
2:	9.9	↗
3:	8.9	↗
4:	9.8	↘
5:	9.6	↘

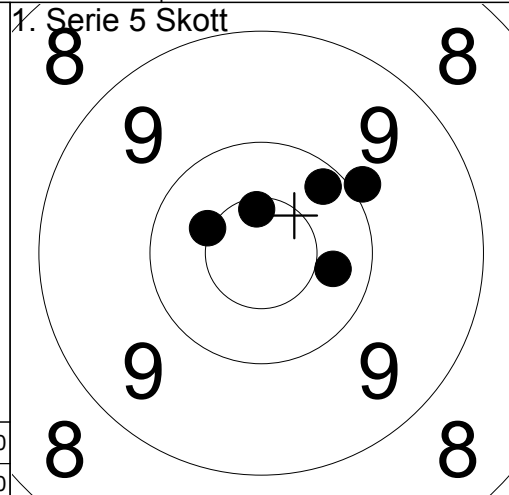

1:	10.3	→
2:	10.2	↗
3:	9.9	↗
4:	10.5x	↖
5:	10.6x	↑

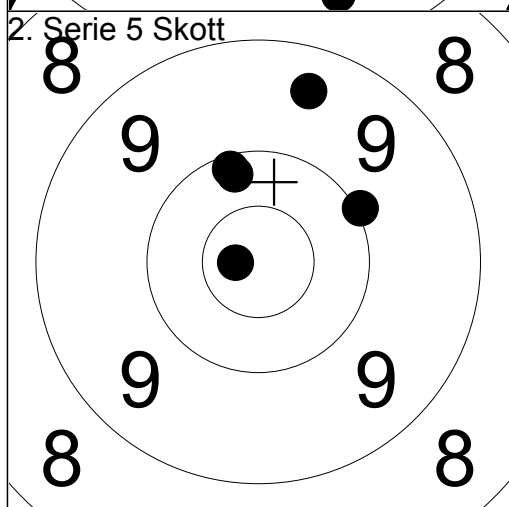

1:	10.1	↑
2:	10.0	→
3:	9.4	↑
4:	10.2	↑
5:	10.8x	←

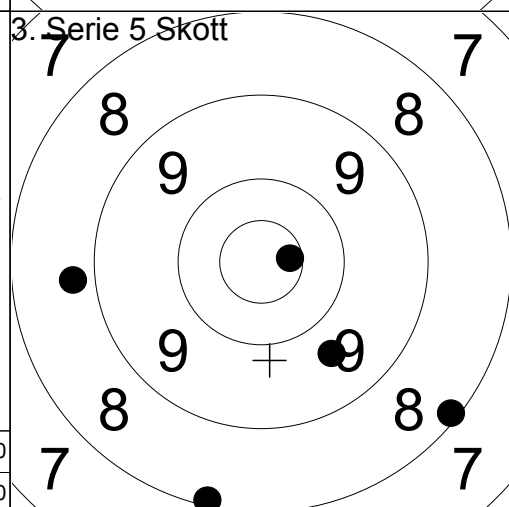

1:	9.7	↘
2:	10.6x	→
3:	8.1	↘
4:	8.8	←
5:	8.1	↘

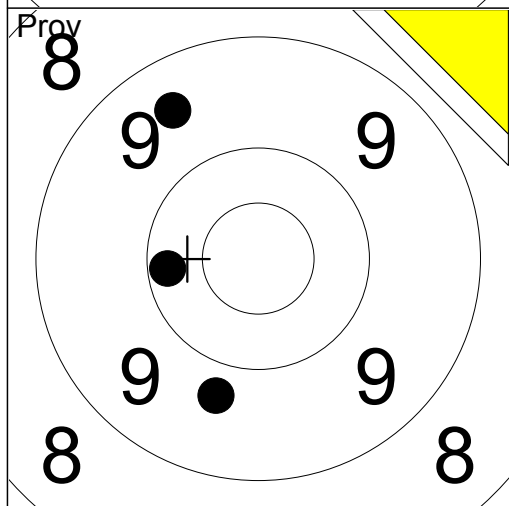

1:	9.7	↘
2:	10.2	←
3:	9.5	↗

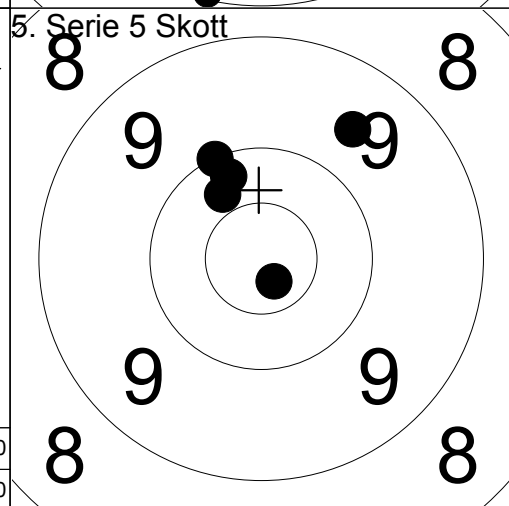

1:	10.7x	↘
2:	10.0	↗
3:	10.2	↗
4:	9.6	↗
5:	10.3	↗

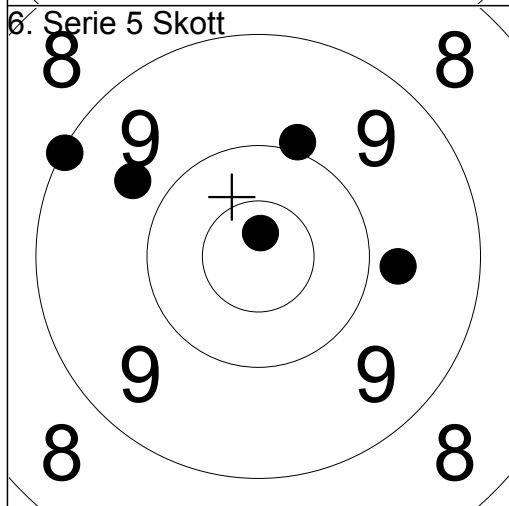

1:	10.8x	↑
2:	9.7	↖
3:	9.9	↑
4:	9.1	↗
5:	9.8	→

Serie	46.0
Total	236.0

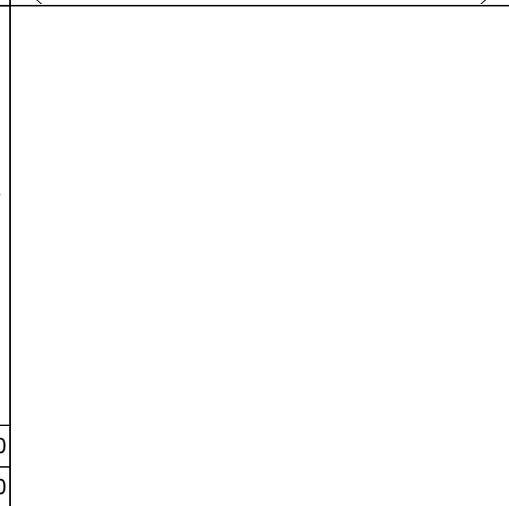

Serie	49.0
Total	190.0

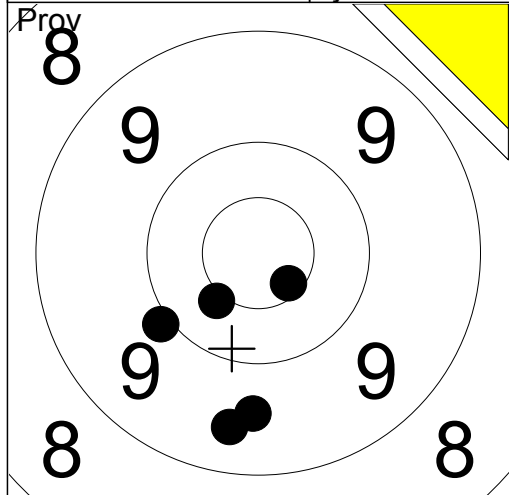

1:	9.4	↘
2:	10.6x	↘
3:	9.9	↙
4:	9.6	↓
5:	10.4x	↙
Serie		47.0
Total		0.0

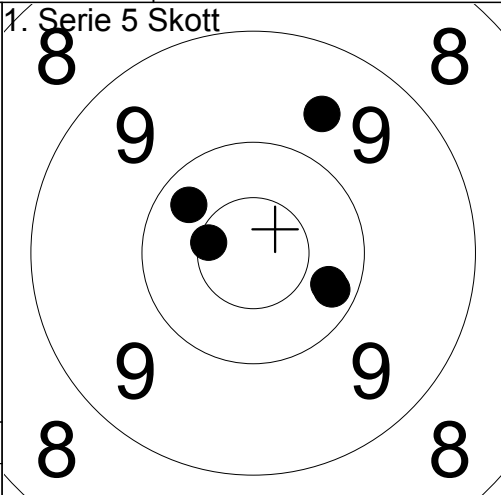

1:	10.2	↘
2:	10.3	↘
3:	9.6	↗
4:	10.6x	↖
5:	10.3	↗
Serie		49.0
Total		49.0

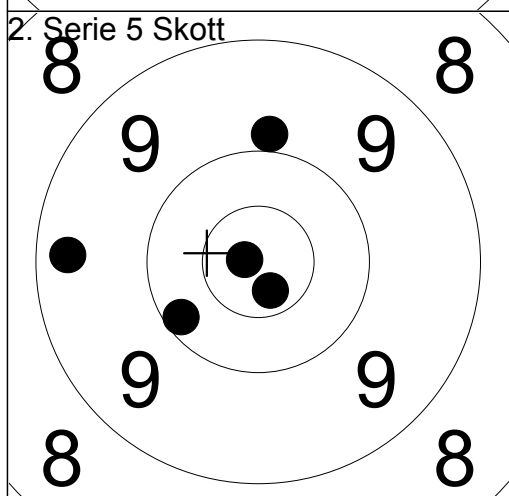

1:	9.3	←
2:	10.7x	↓
3:	9.9	↑
4:	10.2	↙
5:	10.8x	←
Serie		48.0
Total		97.0

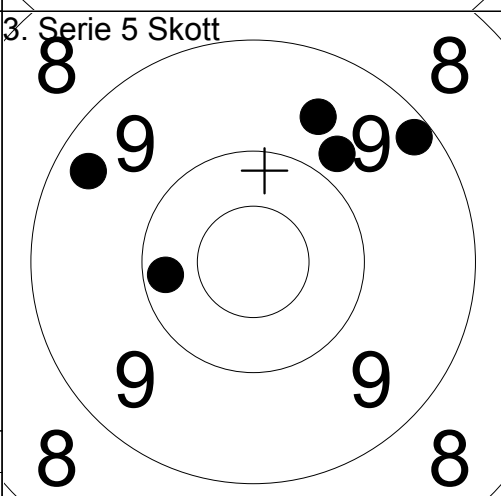

1:	9.6	↗
2:	10.2	←
3:	9.8	↗
4:	9.2	↗
5:	9.3	↖
Serie		46.0
Total		143.0

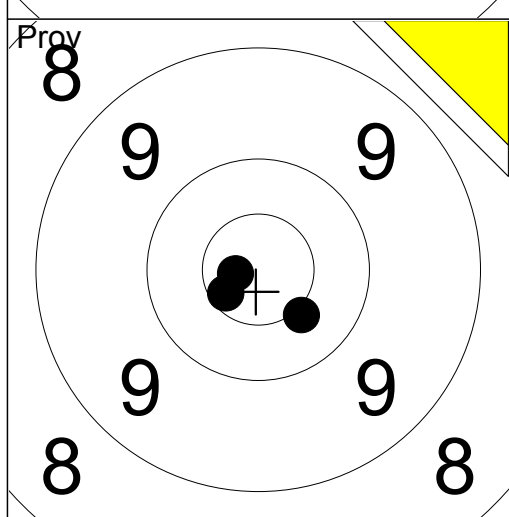

1:	10.6x	↙
2:	10.4x	↘
3:	10.8x	←
Serie		30.0
Total		143.0

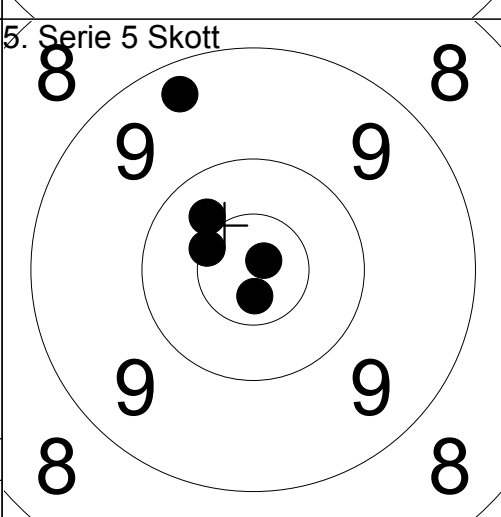

1:	10.7x	↓
2:	9.3	↗
3:	10.4	↗
4:	10.5x	↖
5:	10.8x	↗
Serie		49.0
Total		192.0

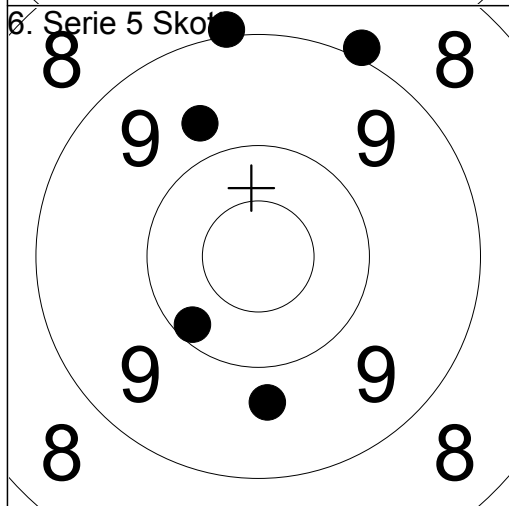

1:	9.7	↓
2:	10.2	↙
3:	9.7	↗
4:	8.9	↗
5:	9.0	↑
Serie		45.0
Total		237.0

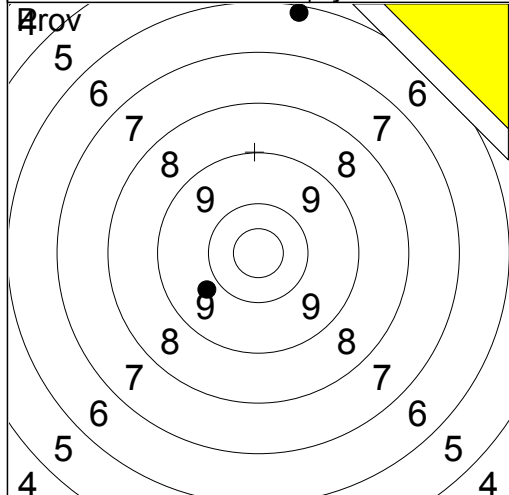

1: 6.2 ↑
2: 9.8 ↙

Serie	15.0
Total	0.0

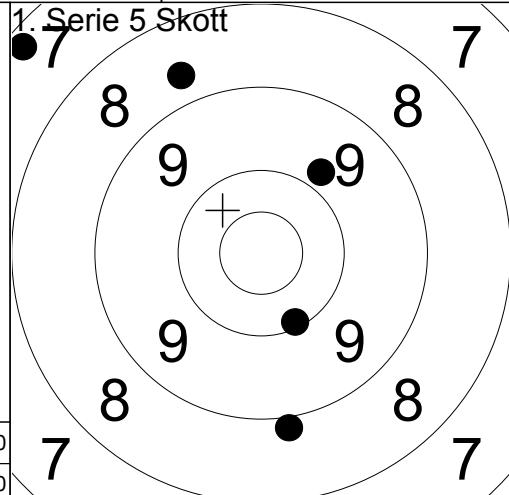

1: 8.9 ↓
2: 9.8 ↗
3: 7.2 ↗
4: 8.7 ↗
5: 10.1 ↓

Serie	42.0
Total	42.0

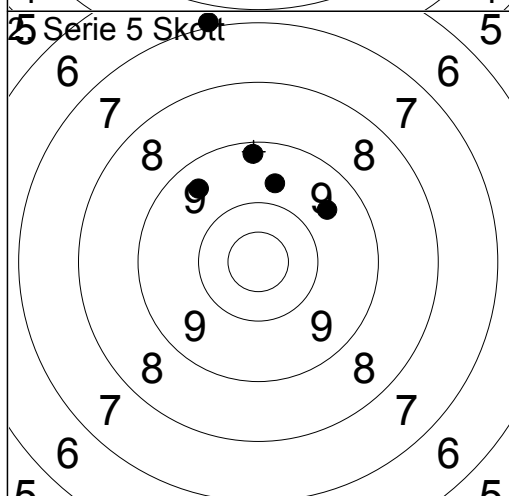

1: 9.2 ↑
2: 9.6 ↗
3: 6.9 ↑
4: 9.5 ↗
5: 9.7 ↑

Serie	42.0
Total	84.0

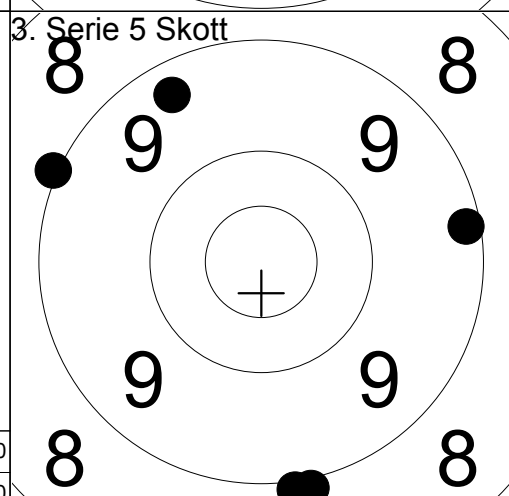

1: 9.3 ↗
2: 8.9 ↓
3: 9.0 ↖
4: 9.0 ↓
5: 9.2 →

Serie	44.0
Total	128.0

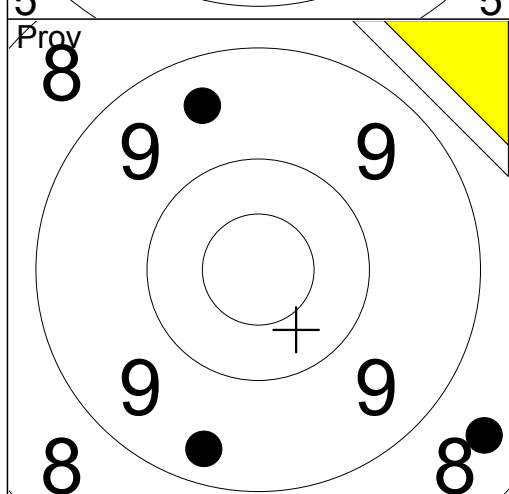

1: 9.5 ↑
2: 8.5 ↓
3: 9.3 ↓

Serie	26.0
Total	128.0

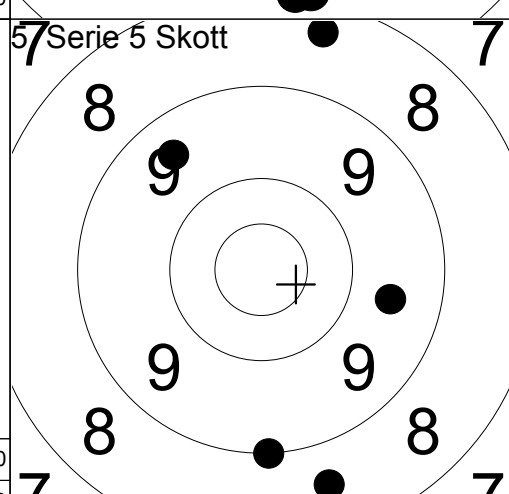

1: 9.6 →
2: 9.5 ↗
3: 8.6 ↓
4: 9.0 ↓
5: 8.4 ↗

Serie	43.0
Total	171.0

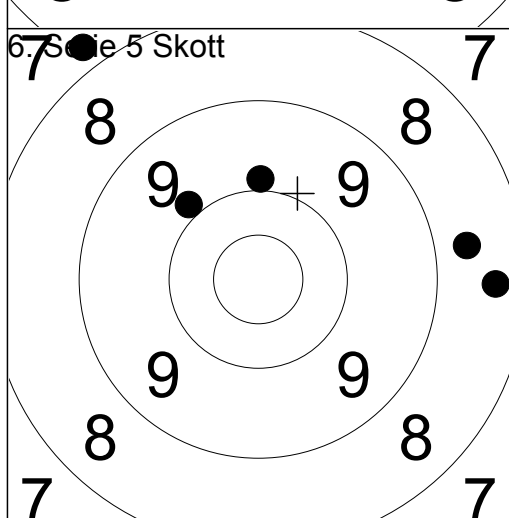

1: 9.9 ↑
2: 9.9 ↗
3: 8.7 →
4: 7.8 ↗
5: 8.4 →

Serie	41.0
Total	212.0

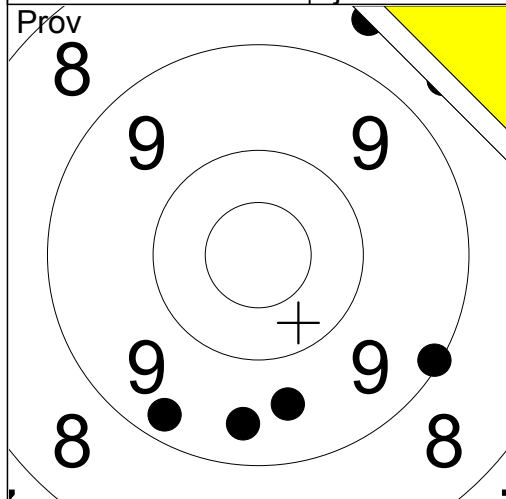

1:	8.6	↗
2:	9.3	↓
3:	9.4	↓
4:	9.1	↘
5:	9.6	↓

Serie	44.0
Total	0.0

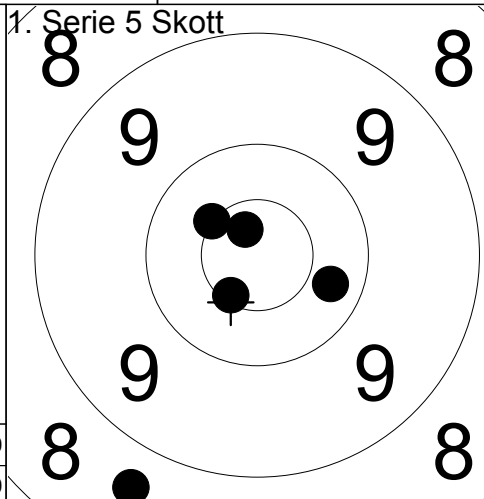

1:	10.3	↘
2:	10.6x	↓
3:	10.7x	↗
4:	10.5x	↗
5:	8.7	↓

Serie	48.0
Total	48.0

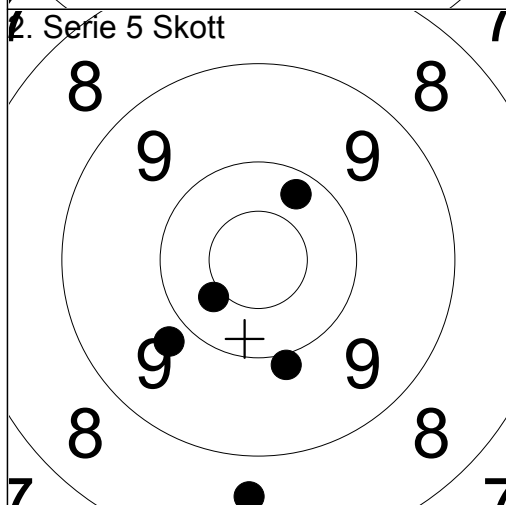

1:	10.2	↗
2:	9.9	↓
3:	8.6	↓
4:	9.8	↙
5:	10.4	↙

Serie	46.0
Total	94.0

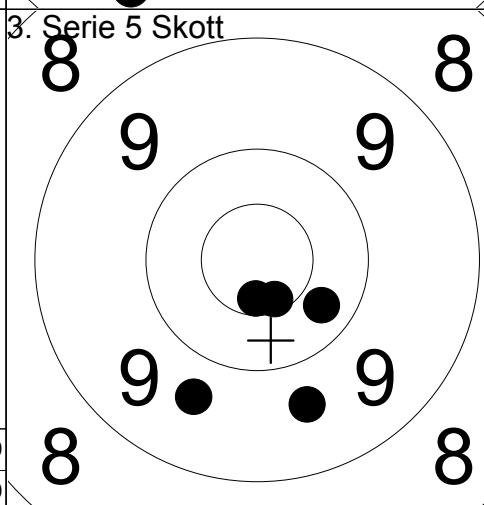

1:	10.6x	↓
2:	10.6x	↓
3:	10.3	↘
4:	9.7	↓
5:	9.7	↓

Serie	48.0
Total	142.0

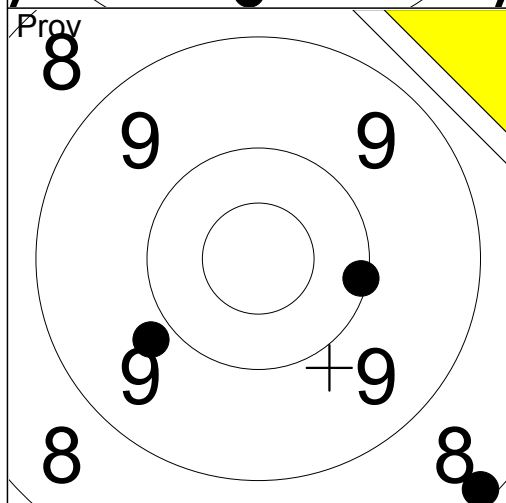

1:	9.8	↙
2:	10.1	→
3:	8.2	↘

Serie	27.0
Total	142.0

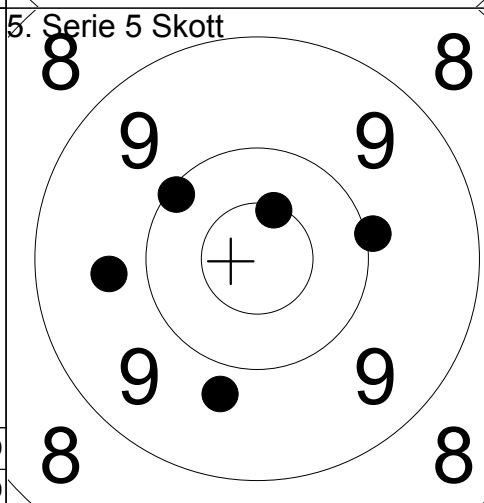

1:	10.5x	↗
2:	10.1	↗
3:	9.8	↓
4:	9.7	←
5:	10.0	→

Serie	48.0
Total	190.0

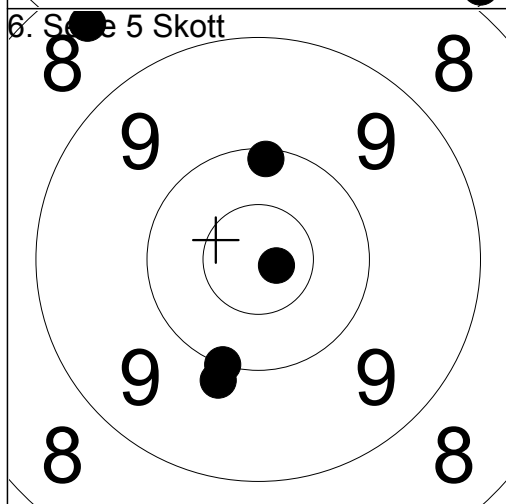

1:	8.4	↗
2:	9.9	↓
3:	10.1	↑
4:	10.0	↓
5:	10.8x	↘

Serie	47.0
Total	237.0

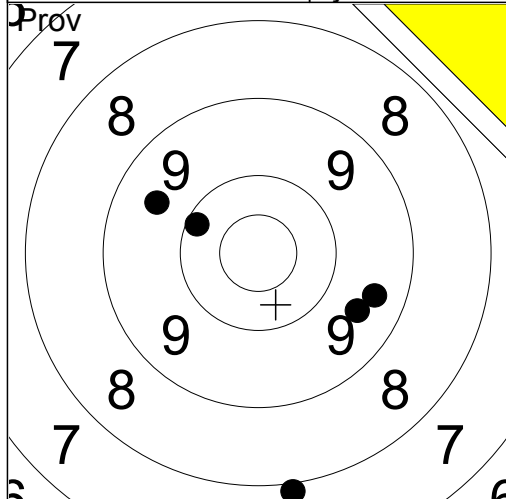

1:	9.4	↘
2:	7.9	↘
3:	9.5	↘
4:	10.1	↗
5:	9.6	↗

Serie	44.0
Total	0.0

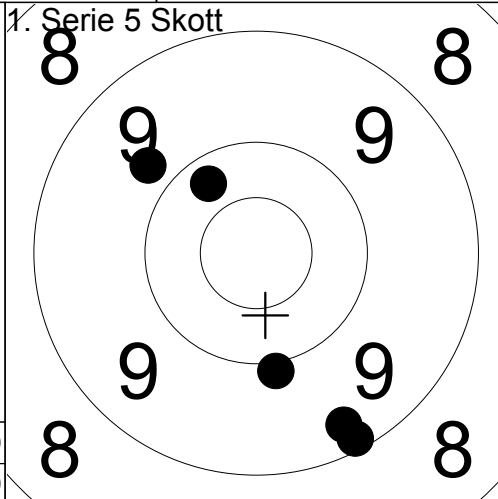

1:	9.1	↘
2:	9.3	↘
3:	10.0	↘
4:	9.8	↗
5:	10.2	↗

Serie	47.0
Total	47.0

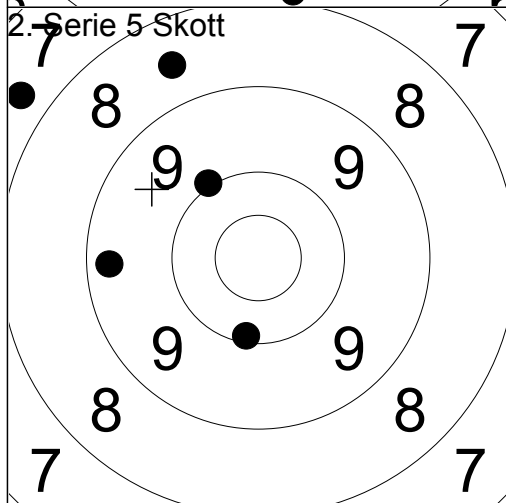

1:	8.6	↗
2:	10.1	↘
3:	10.0	↗
4:	9.3	↖
5:	7.7	↗

Serie	44.0
Total	91.0

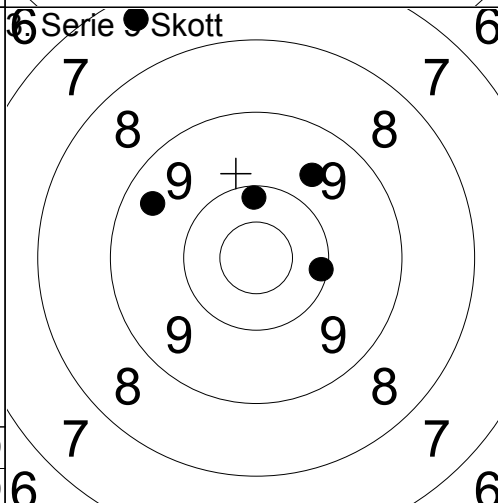

1:	9.4	↖
2:	10.2	↗
3:	9.7	↗
4:	10.1	→
5:	7.4	↗

Serie	45.0
Total	136.0

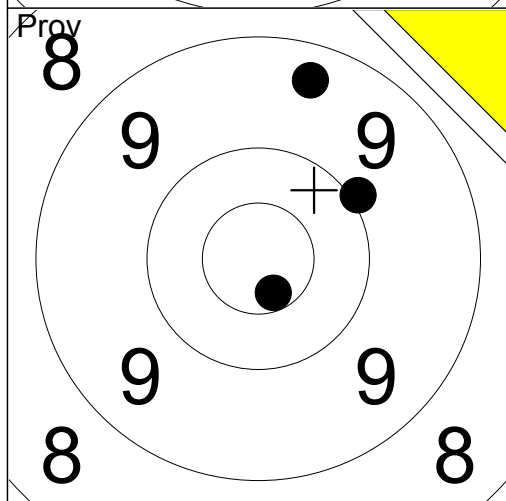

1:	9.4	↗
2:	10.0	↗
3:	10.6x	↘

Serie	29.0
Total	136.0

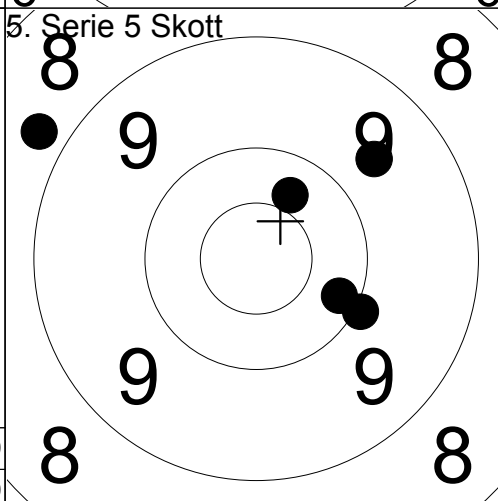

1:	10.4	↗
2:	10.2	→
3:	9.6	↗
4:	8.8	↗
5:	10.0	↘

Serie	47.0
Total	183.0

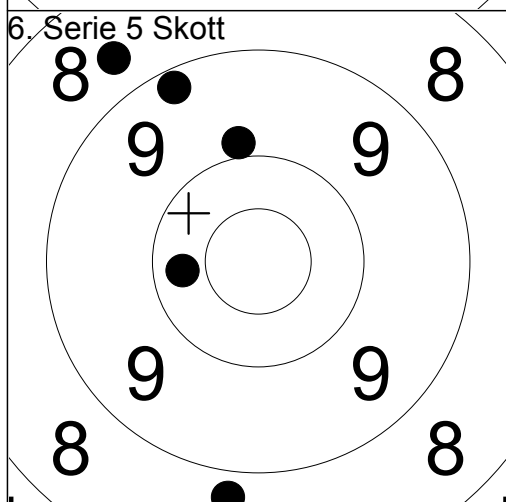

1:	10.3	←
2:	8.8	↘
3:	8.7	↗
4:	9.9	↗
5:	9.2	↗

Serie	44.0
Total	227.0

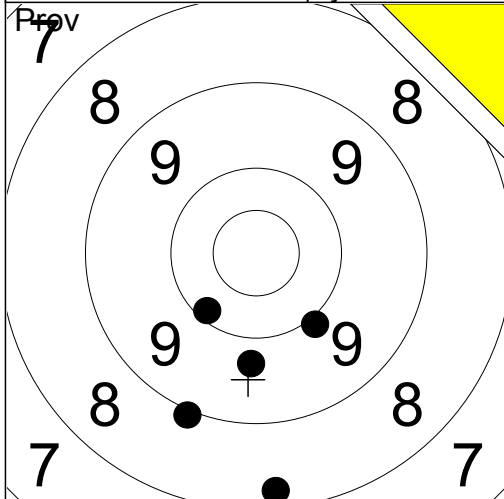

1:	10.1	↙
2:	9.7	↓
3:	9.9	↘
4:	8.2	↓
5:	9.0	↓

Serie	45.0
Total	0.0

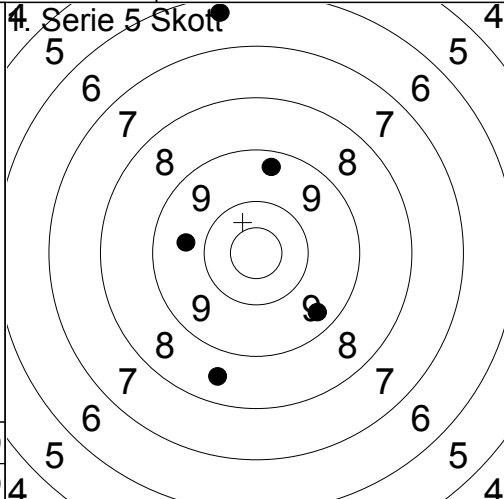

1:	6.3	↑
2:	9.4	↘
3:	8.5	↓
4:	9.3	↑
5:	9.7	←

Serie	41.0
Total	41.0

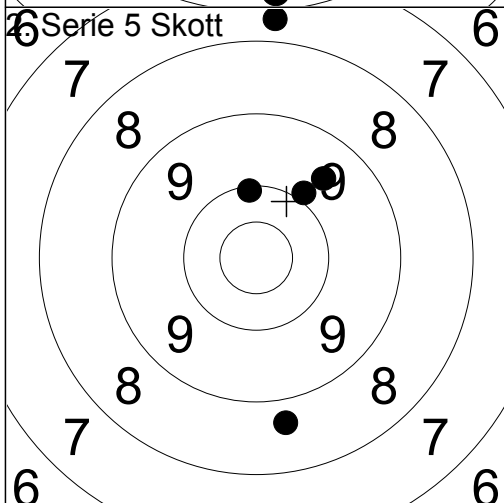

1:	7.7	↑
2:	9.6	↗
3:	10.1	↑
4:	8.7	↓
5:	9.9	↗

Serie	43.0
Total	84.0

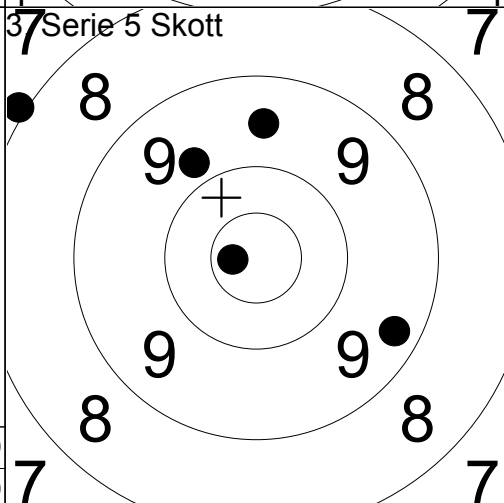

1:	9.8	↗
2:	10.7x	←
3:	9.3	↘
4:	8.0	↗
5:	9.6	↑

Serie	45.0
Total	129.0

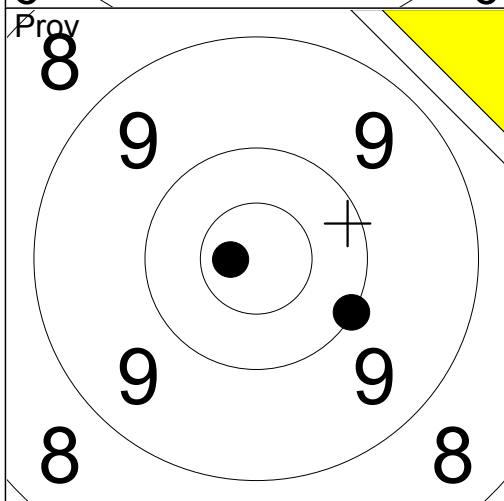

1:	8.7	↗
2:	10.0	↘
3:	10.7x	←

Serie	28.0
Total	129.0

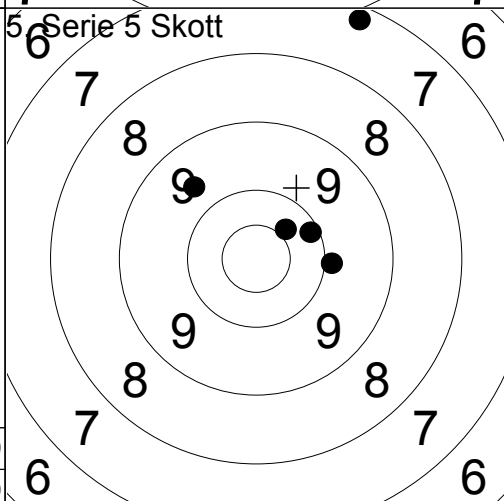

1:	9.9	→
2:	7.2	↑
3:	9.6	↗
4:	10.1	→
5:	10.4	↗

Serie	45.0
Total	174.0

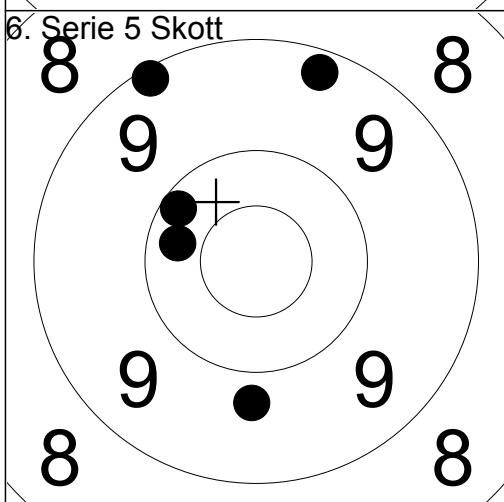

1:	10.3	←
2:	10.2	↗
3:	9.1	↗
4:	9.2	↗
5:	9.8	↓

Serie	47.0
Total	221.0

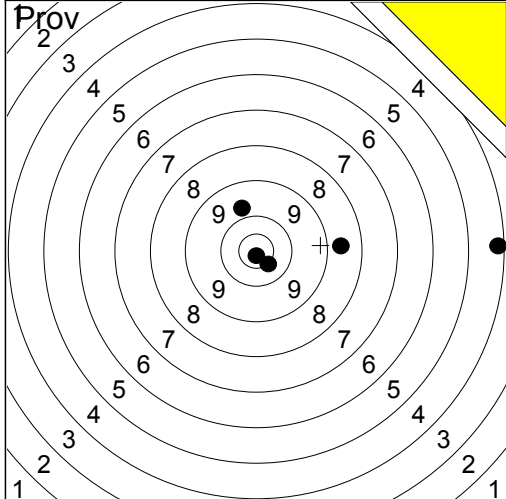

1:	4.2	→
2:	8.6	→
3:	9.8	↑
4:	10.5x	↓
5:	10.8x	↓

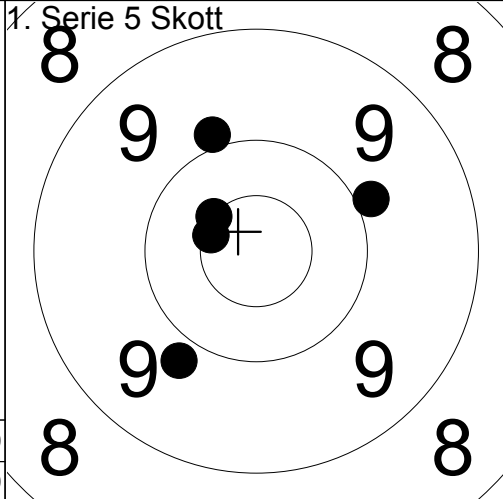

1:	9.9	→
2:	10.6x	←
3:	10.5x	↑
4:	9.9	↑
5:	9.8	↓

Serie	41.0
Total	0.0

Serie	47.0
Total	47.0

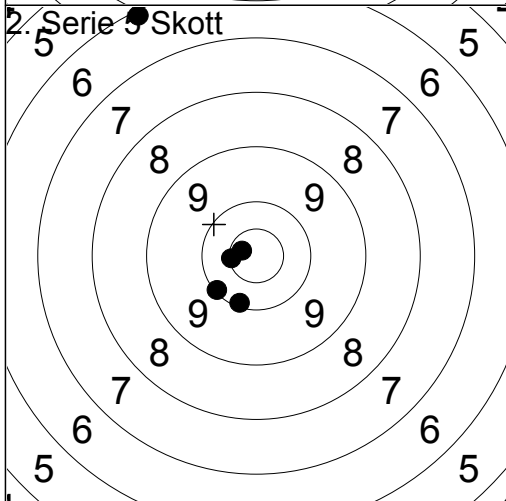

1:	6.1	↑
2:	10.5x	←
3:	10.7x	←
4:	10.1	↓
5:	10.1	←

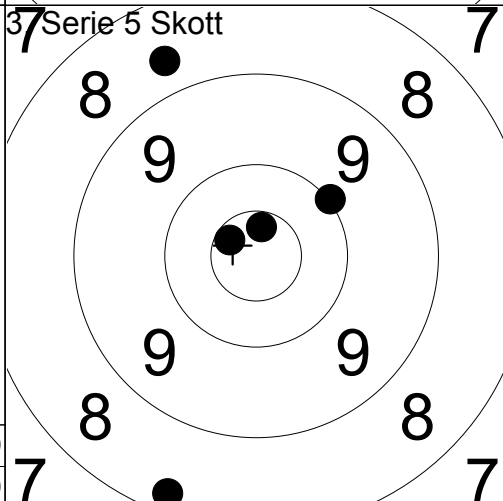

1:	10.6x	←
2:	10.7x	↑
3:	10.0	↗
4:	8.3	↓
5:	8.7	↑

Serie	46.0
Total	93.0

Serie	46.0
Total	139.0

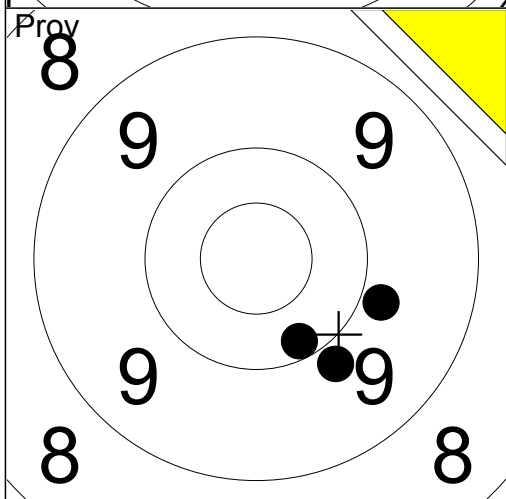

1:	9.8	→
2:	10.2	↓
3:	9.8	↓

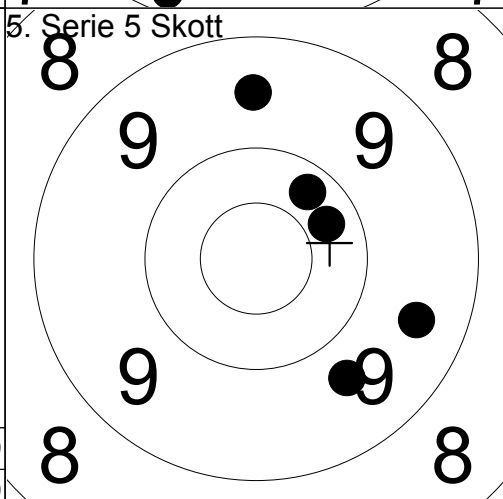

1:	10.2	↗
2:	9.5	→
3:	9.5	↑
4:	10.3	↗
5:	9.7	↓

Serie	28.0
Total	139.0

Serie	47.0
Total	186.0

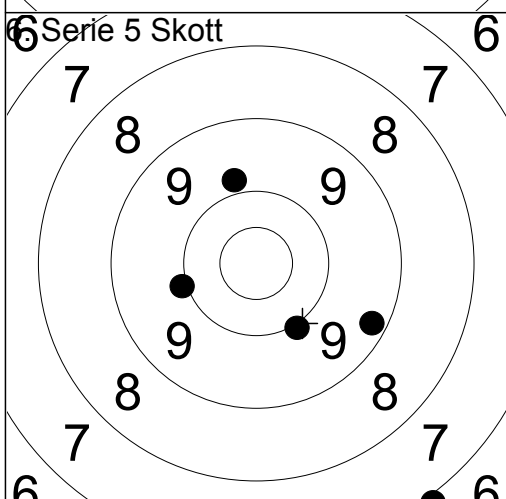

1:	9.8	↑
2:	9.2	↘
3:	10.0	←
4:	6.9	↘
5:	10.0	↓

Serie	44.0
Total	230.0

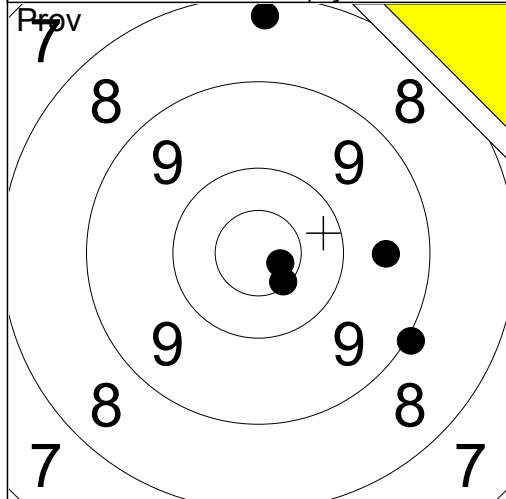

1. Serie 5 Skott

1:	8.3	↑
2:	9.0	↘
3:	10.5x	↘
4:	9.5	→
5:	10.7x	↘
Serie	46.0	
Total	0.0	

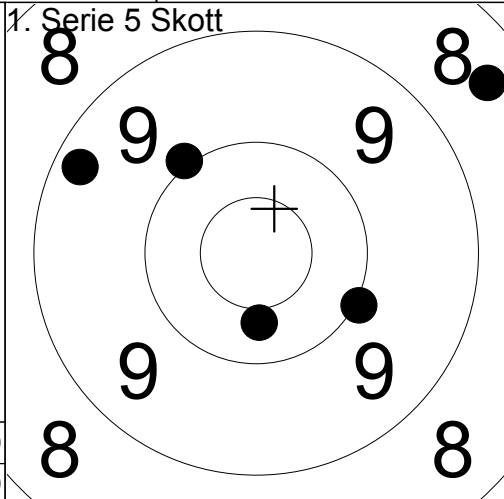

1:	8.4	↗
2:	10.0	↘
3:	10.0	↗
4:	10.4	↘
5:	9.3	↗
Serie	47.0	
Total	47.0	

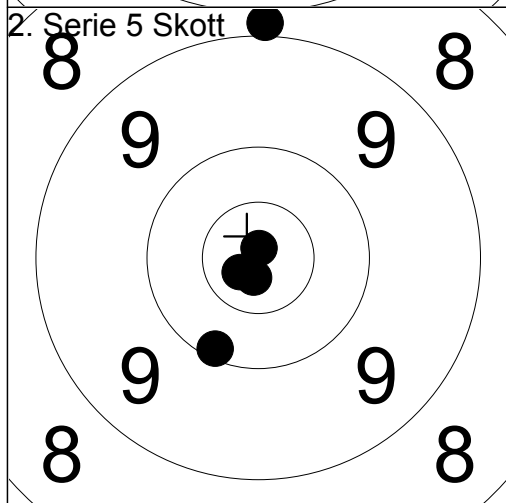

2. Serie 5 Skott

1:	8.9	↑
2:	10.8x	↘
3:	10.1	↘
4:	10.8x	↙
5:	10.9x	↑
Serie	48.0	
Total	95.0	

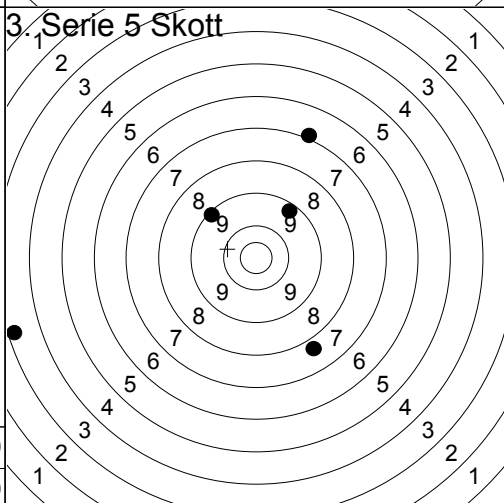

3. Serie 5 Skott

1:	9.1	↖
2:	9.3	↗
3:	7.7	↘
4:	6.9	↗
5:	3.2	←
Serie	34.0	
Total	129.0	

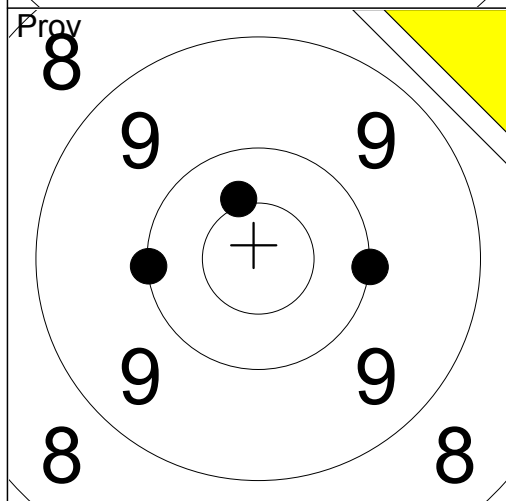

4. Serie 5 Skott

1:	10.4x	↑
2:	10.0	→
3:	10.0	←
Serie	30.0	
Total	129.0	

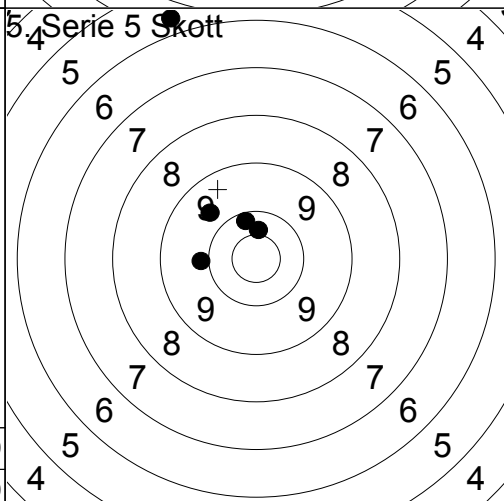

1:	5.7	↑
2:	10.4	↑
3:	10.2	↑
4:	9.9	←
5:	9.7	↗
Serie	43.0	
Total	172.0	

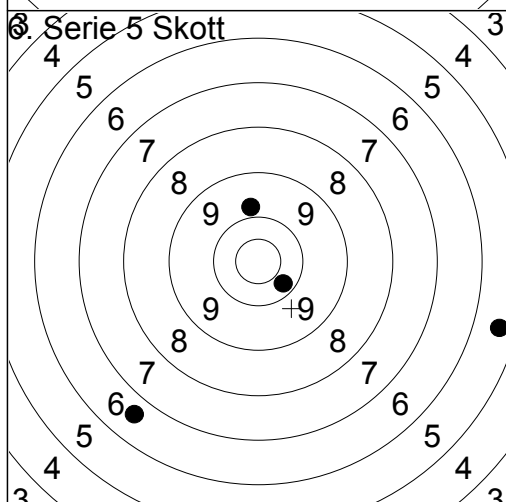

5. Serie 5 Skott

1:	9.8	↑
2:	10.3	↘
3:	0.0	
4:	6.6	↘
5:	5.4	→
Serie	30.0	
Total	202.0	

Skjutlag 2 Tavla 3 **Rune Skarpsvärd**

300m Pajala Vet No

09.07.2016 Björkskottet 2016 Ramselefors SKF

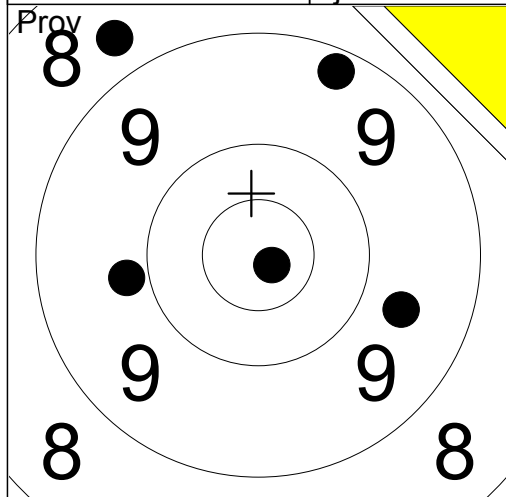

1:	9.2	↗
2:	8.7	↗
3:	9.8	↖
4:	10.8x	↘
5:	9.7	↘
Serie	45.0	
Total	0.0	

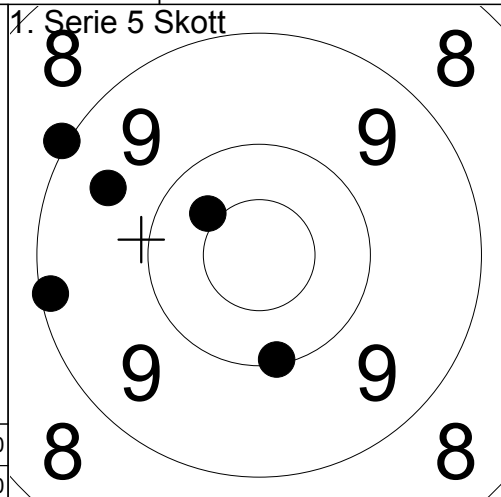

1:	10.1	↘
2:	10.4	↗
3:	9.5	↖
4:	9.1	↖
5:	9.0	↗
Serie	47.0	
Total	47.0	

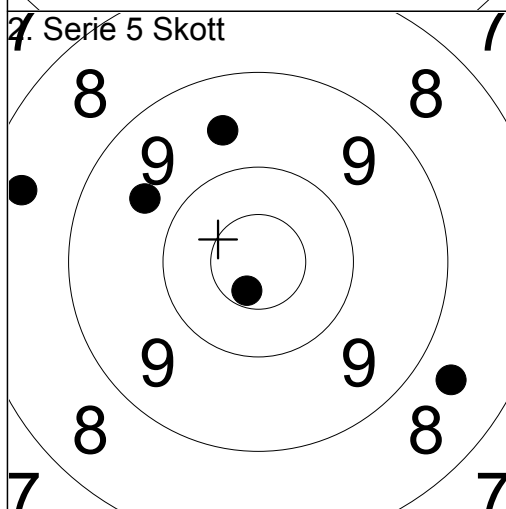

1:	8.6	↘
2:	9.6	↗
3:	9.7	↗
4:	8.4	↖
5:	10.6x	↘
Serie	44.0	
Total	91.0	

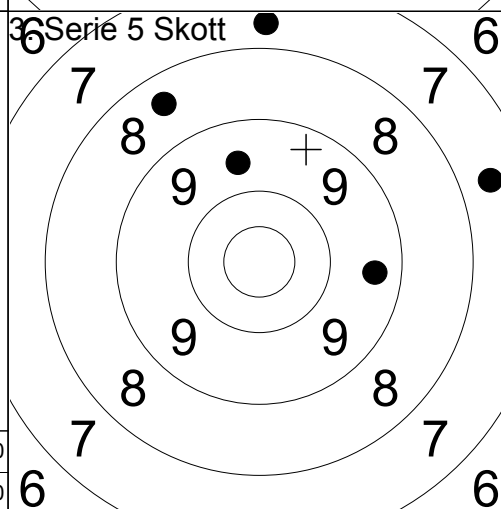

1:	9.4	→
2:	9.6	↑
3:	8.4	↗
4:	7.7	↑
5:	7.6	→
Serie	40.0	
Total	131.0	

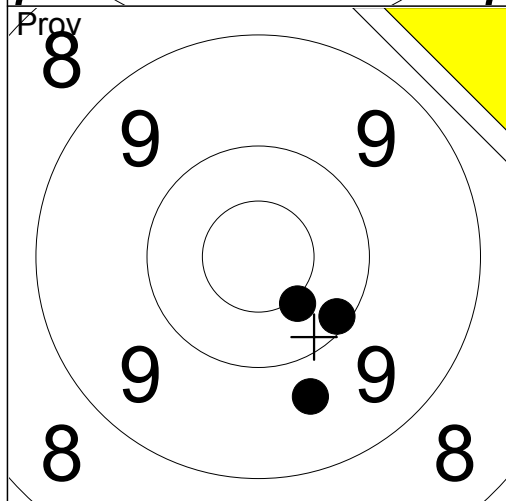

1:	9.7	↘
2:	10.4x	↘
3:	10.1	↘
Serie	29.0	
Total	131.0	

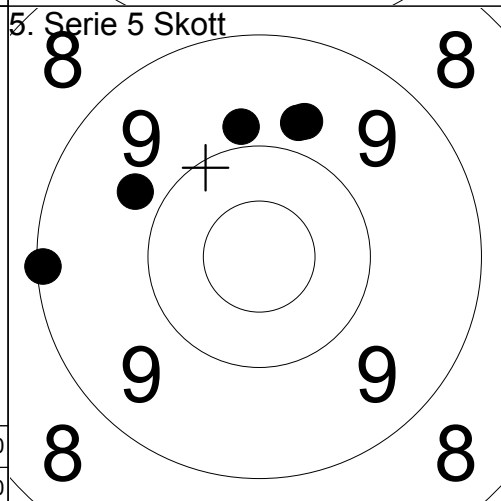

1:	9.7	↑
2:	9.1	↖
3:	9.8	↖
4:	9.8	↑
5:	9.9	↑
Serie	45.0	
Total	176.0	

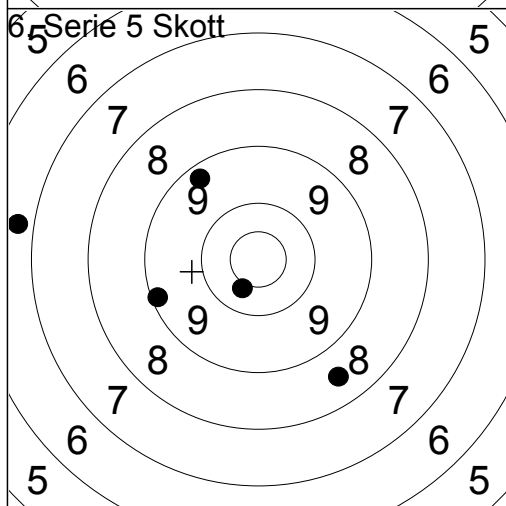

1:	10.4	↘
2:	8.5	↘
3:	9.1	↖
4:	9.3	↗
5:	6.8	↖
Serie	42.0	
Total	218.0	

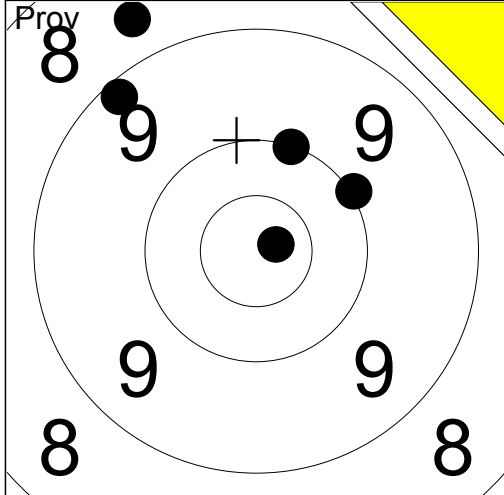

1:	9.2	↖
2:	8.7	↖
3:	10.0	↖
4:	10.8x	→
5:	10.0	↗
Serie		47.0
Total		0.0

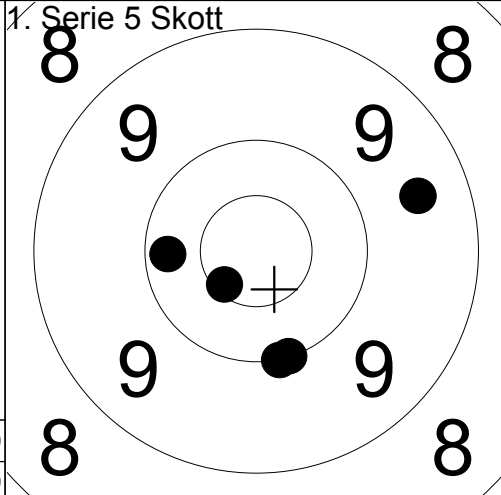

1:	10.0	↓
2:	10.6x	↙
3:	10.0	↓
4:	9.5	→
5:	10.2	←
Serie		49.0
Total		49.0

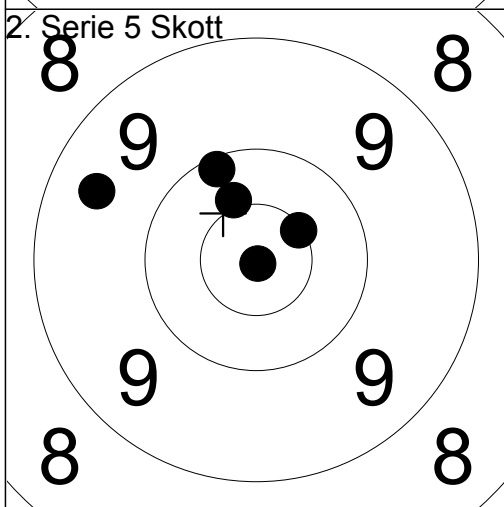

1:	10.4x	↖
2:	10.9x	↙
3:	10.1	↖
4:	9.5	↖
5:	10.5x	↗
Serie		49.0
Total		98.0

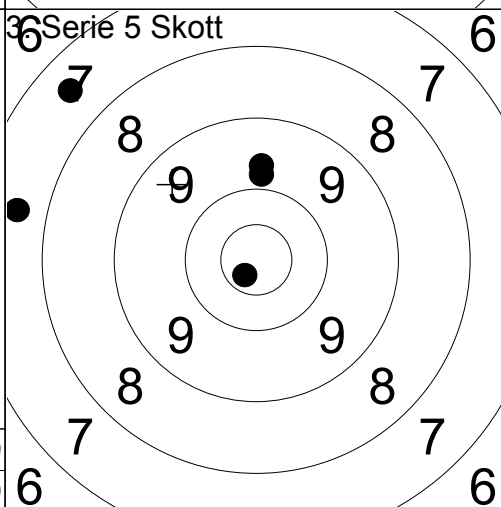

1:	9.8	↑
2:	9.7	↑
3:	10.7x	↙
4:	7.6	←
5:	7.5	↖
Serie		42.0
Total		140.0

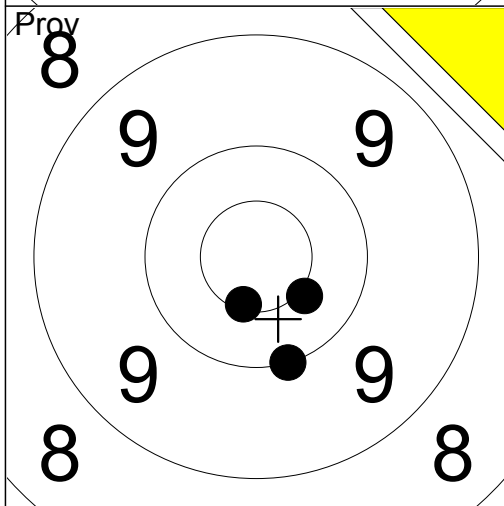

1:	10.5x	↓
2:	10.4x	↓
3:	10.0	↓
Serie		30.0
Total		140.0

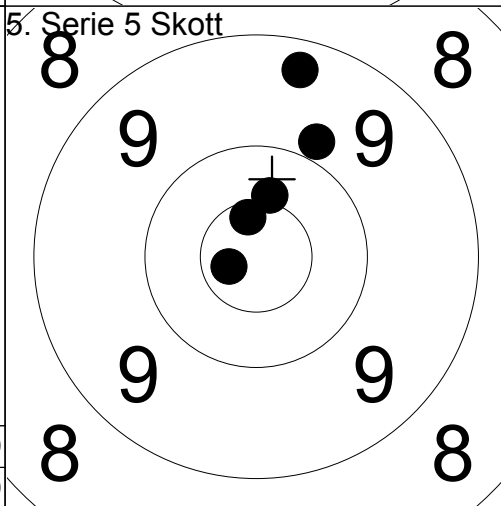

1:	10.4x	↑
2:	10.6x	↑
3:	10.7x	←
4:	9.3	↑
5:	9.9	↗
Serie		48.0
Total		188.0

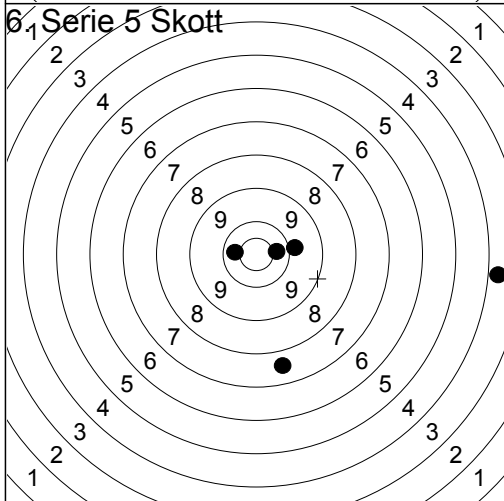

1:	9.8	→
2:	10.4	→
3:	10.4	←
4:	3.7	→
5:	7.6	↓
Serie		39.0
Total		227.0

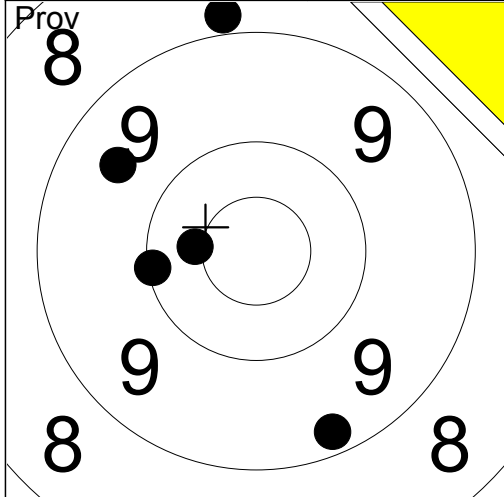

1:	9.5	↖
2:	8.9	↑
3:	10.1	←
4:	10.4x	←
5:	9.2	↓

Serie	46.0
Total	0.0

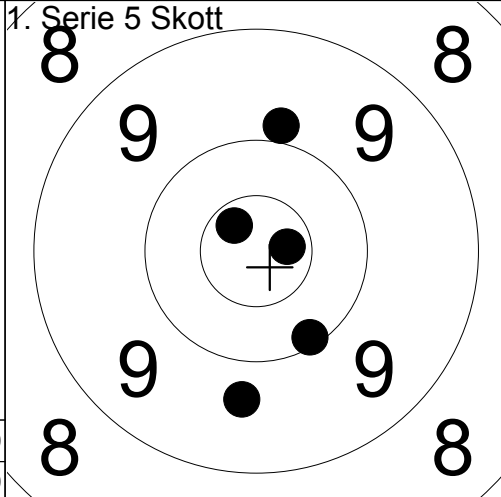

1:	9.9	↑
2:	10.7x	↖
3:	10.7x	→
4:	9.7	↓
5:	10.1	↘

Serie	48.0
Total	48.0

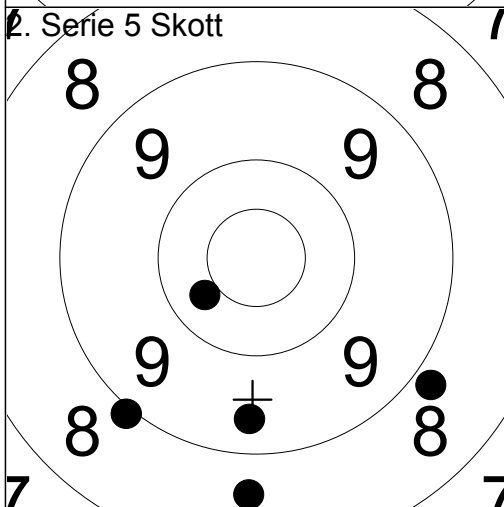

1:	8.8	↘
2:	10.4	↖
3:	8.6	↓
4:	9.4	↓
5:	9.0	↘

Serie	44.0
Total	92.0

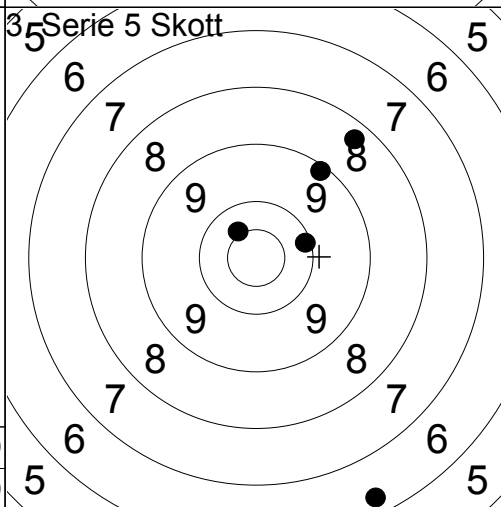

1:	10.1	→
2:	10.4x	↖
3:	9.1	↗
4:	8.3	↗
5:	6.3	↓

Serie	43.0
Total	135.0

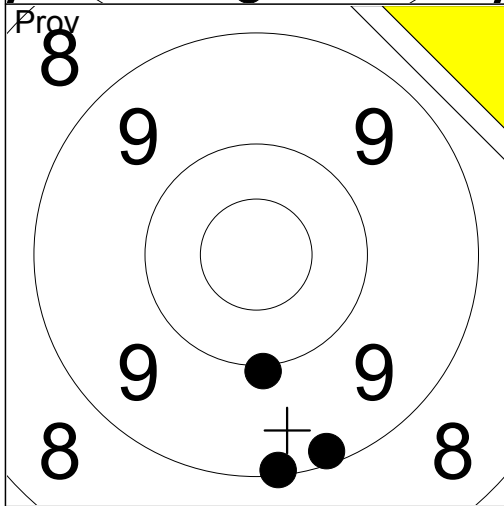

1:	9.1	↓
2:	10.0	↓
3:	9.2	↓

Serie	28.0
Total	135.0

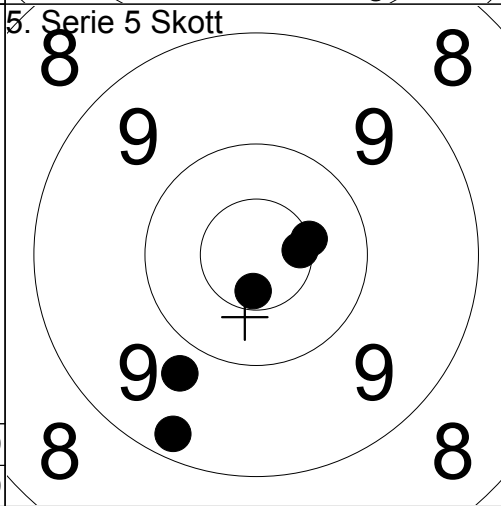

1:	9.3	↓
2:	10.5x	→
3:	10.6x	→
4:	10.6x	↓
5:	9.8	↘

Serie	48.0
Total	183.0

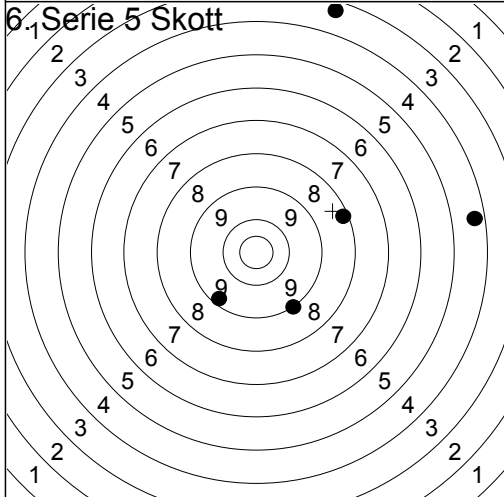

1:	9.2	↘
2:	8.2	→
3:	9.0	↘
4:	3.3	↑
5:	4.3	→

Serie	33.0
Total	216.0

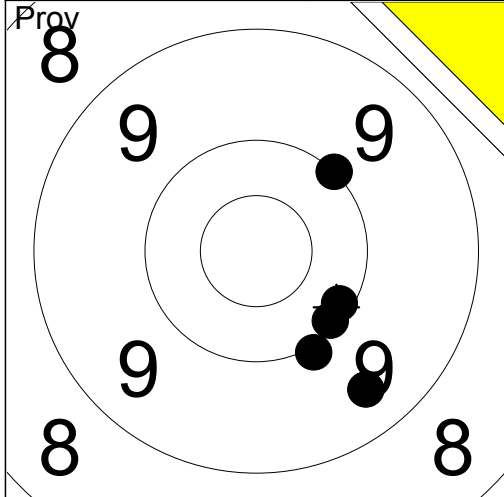

1:	10.0	↗
2:	10.0	↘
3:	10.1	↘
4:	9.4	↘
5:	10.1	↘
Serie		49.0
Total		0.0

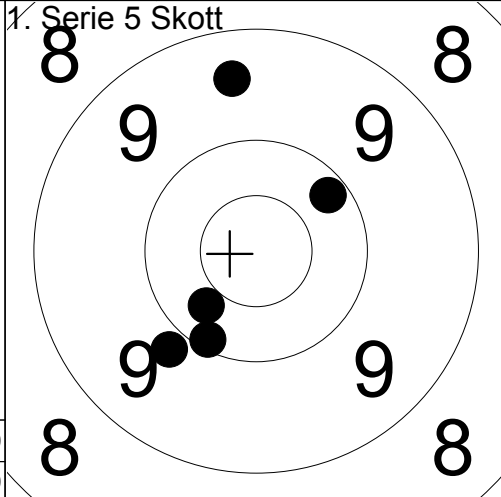

1:	10.3	↘
2:	10.1	↘
3:	10.2	↗
4:	9.5	↑
5:	9.8	↘
Serie		48.0
Total		48.0

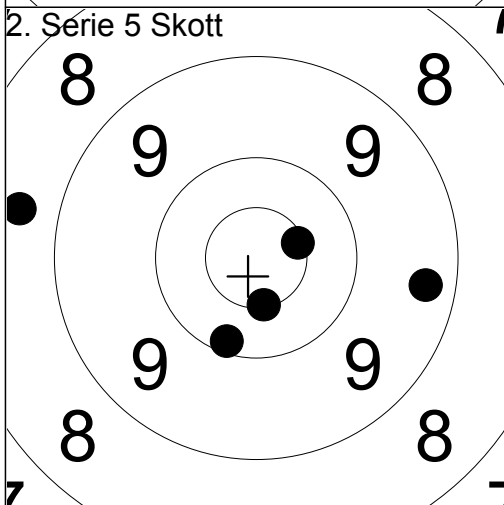

1:	10.5x	→
2:	8.6	←
3:	10.1	↘
4:	10.5x	↘
5:	9.3	→
Serie		47.0
Total		95.0

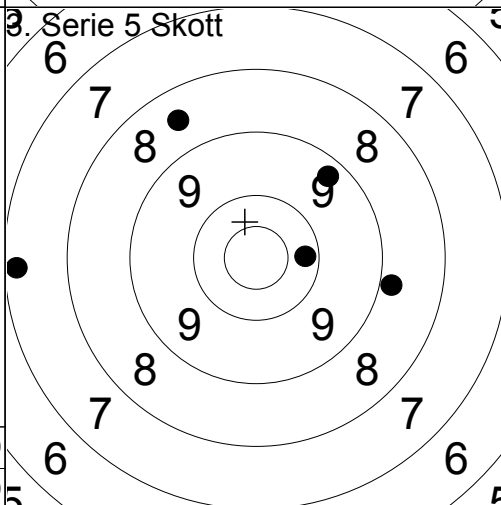

1:	8.5	↗
2:	9.3	↗
3:	8.8	→
4:	7.2	←
5:	10.2	→
Serie		42.0
Total		137.0

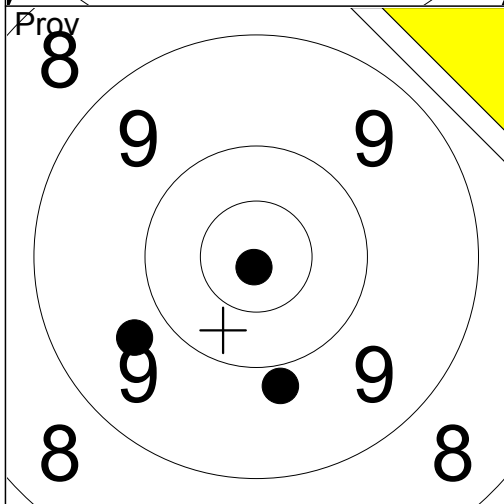

1:	9.7	↘
2:	9.8	↘
3:	10.9x	↘
Serie		28.0
Total		137.0

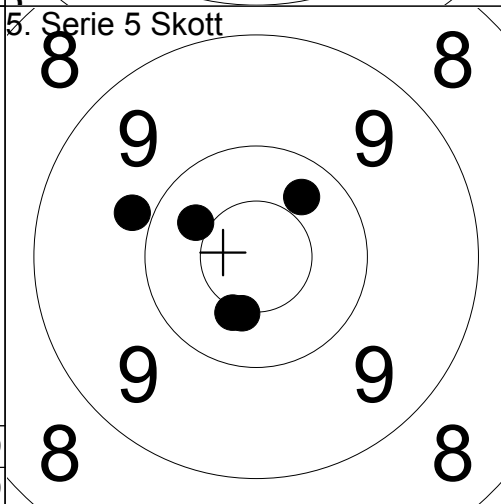

1:	10.3	↗
2:	9.8	←
3:	10.4x	↘
4:	10.5x	↘
5:	10.4	↗
Serie		49.0
Total		186.0

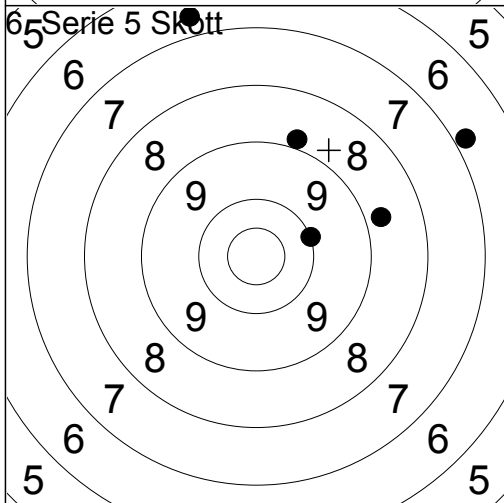

1:	8.8	→
2:	8.9	↑
3:	6.8	↗
4:	6.7	↑
5:	10.0	→
Serie		38.0
Total		224.0

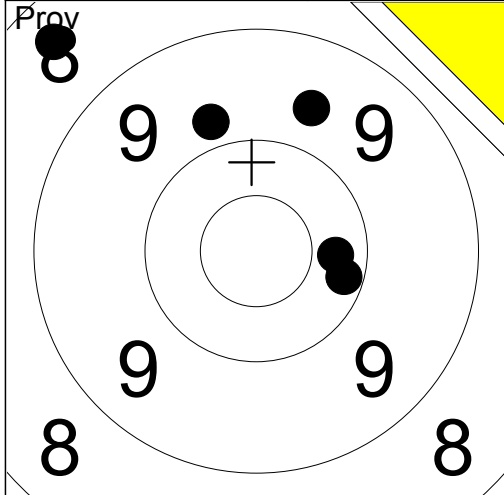

1:	8.4	↗
2:	10.3	→
3:	9.7	↗
4:	9.8	↗
5:	10.2	→

Serie	46.0
Total	0.0

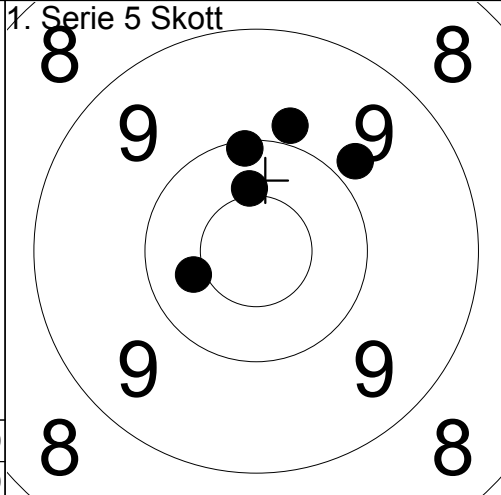

1:	9.8	↗
2:	10.4x	↑
3:	10.1	↑
4:	10.4	←
5:	9.9	↑

Serie	48.0
Total	48.0

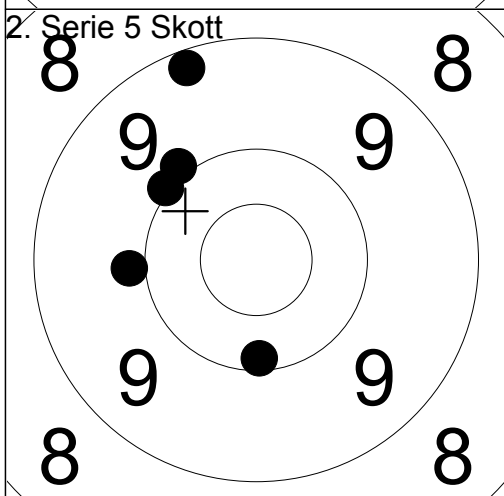

1:	9.2	↑
2:	10.0	↗
3:	9.9	←
4:	9.9	↗
5:	10.1	↓

Serie	47.0
Total	95.0

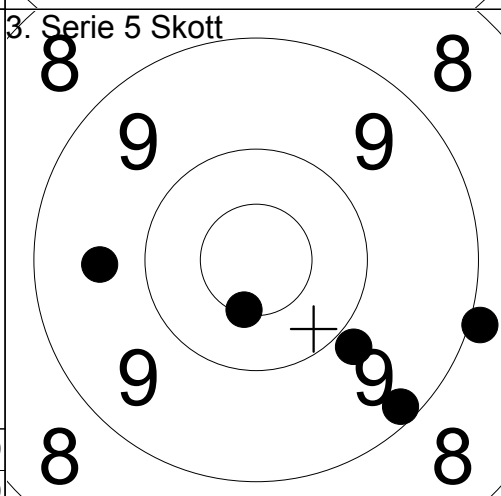

1:	10.5x	↓
2:	9.2	↓
3:	9.9	↘
4:	9.6	←
5:	8.9	→

Serie	45.0
Total	140.0

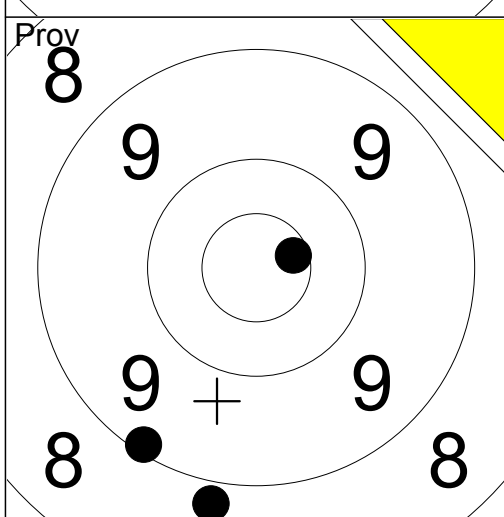

1:	9.1	↘
2:	10.6x	→
3:	8.8	↓

Serie	27.0
Total	140.0

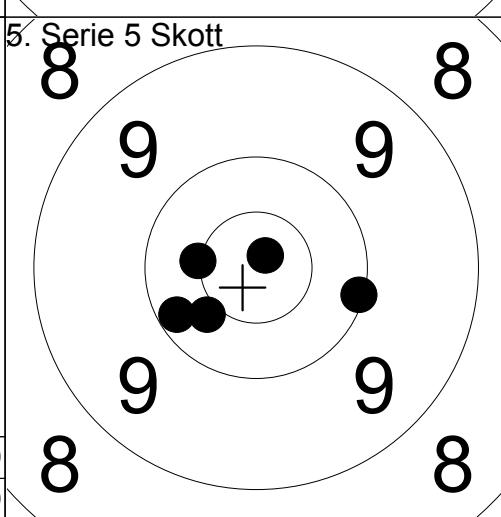

1:	10.5x	←
2:	10.2	←
3:	10.1	→
4:	10.4	↘
5:	10.8x	↗

Serie	50.0
Total	190.0

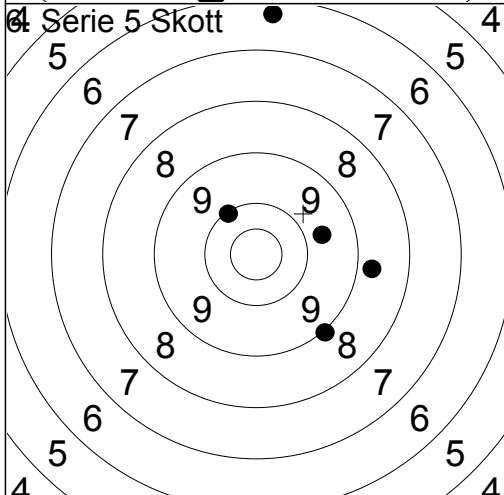

1:	8.8	→
2:	9.0	↘
3:	6.3	↑
4:	10.1	↗
5:	9.7	→

Serie	42.0
Total	232.0

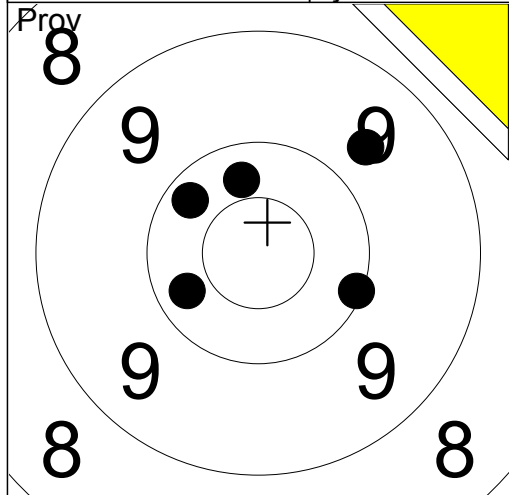

1. Serie 5 Skott

1:	10.3	←
2:	10.2	↖
3:	10.3	↑
4:	9.7	↗
5:	10.1	→

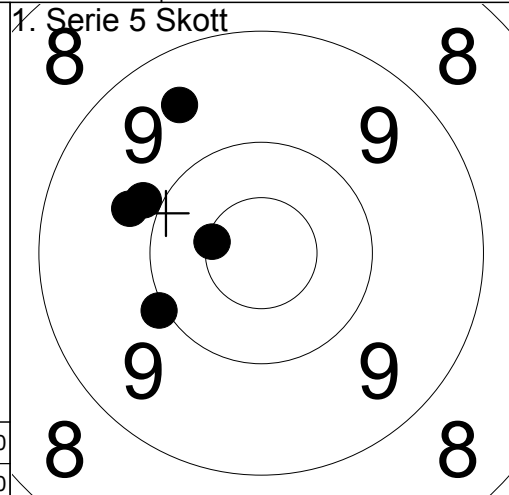

1:	9.5	↗
2:	10.0	↖
3:	10.5x	←
4:	9.9	↗
5:	9.8	↖

Serie	49.0
Total	0.0

Serie	47.0
Total	47.0

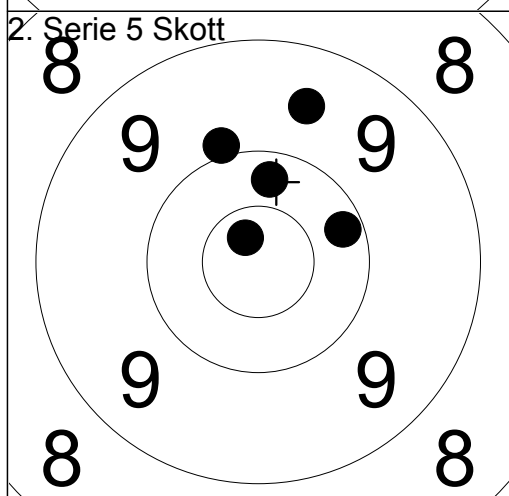

1:	10.2	→
2:	9.6	↑
3:	9.9	↑
4:	10.3	↑
5:	10.7x	↖

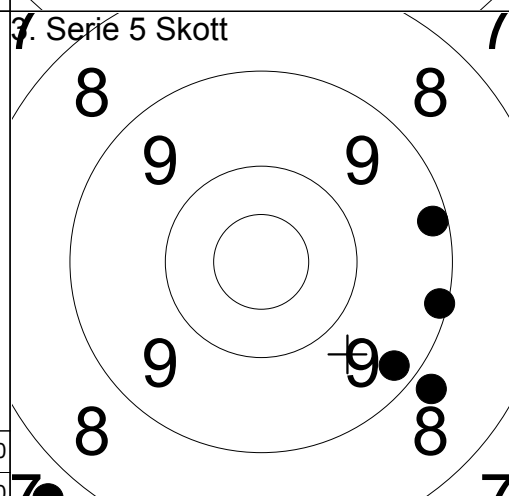

1:	8.8	↘
2:	9.3	↘
3:	9.1	→
4:	9.2	→
5:	7.7	↖

Serie	48.0
Total	95.0

Serie	42.0
Total	137.0

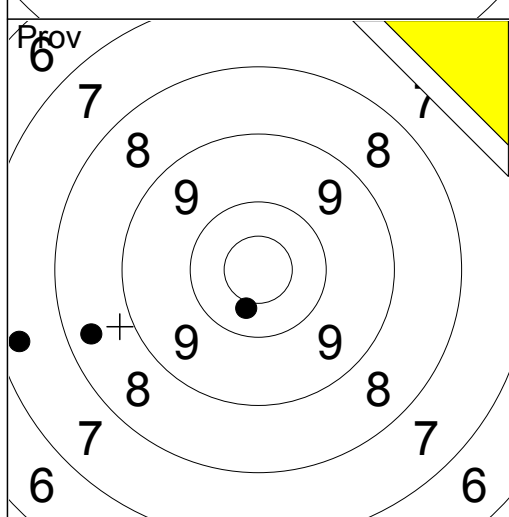

4. Serie 5 Skott

1:	7.4	←
2:	8.4	←
3:	10.4	↘

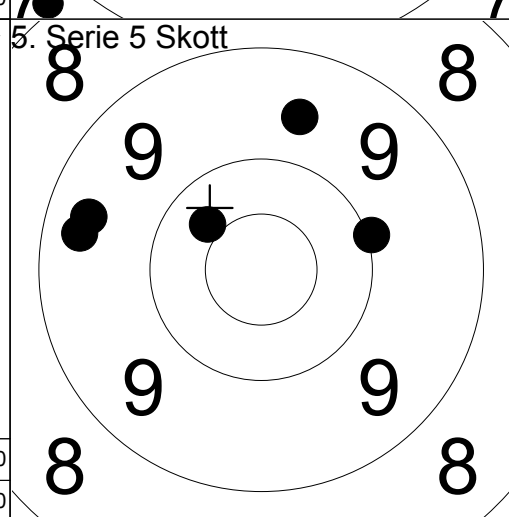

1:	9.4	←
2:	9.4	←
3:	10.4	↗
4:	9.6	↑
5:	10.0	→

Serie	25.0
Total	137.0

Serie	47.0
Total	184.0

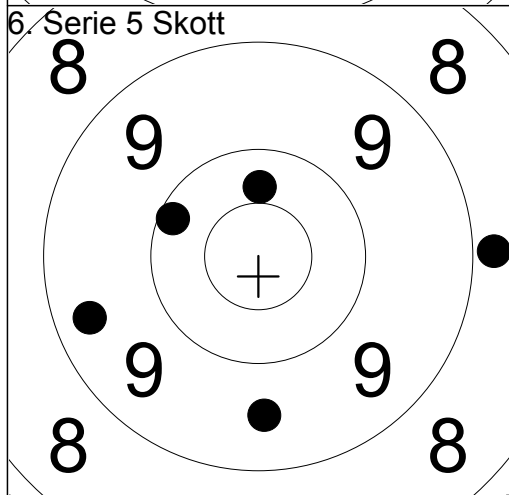

1:	9.6	↓
2:	10.1	↖
3:	8.8	→
4:	10.3	↑
5:	9.4	←

Serie	46.0
Total	230.0

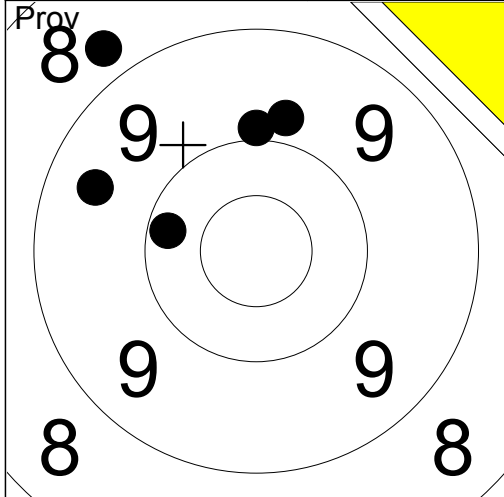

1. Serie 5 Skott

1:	8.8	↖
2:	9.5	↖
3:	9.8	↑
4:	9.9	↑
5:	10.2	↖
Serie	45.0	
Total	0.0	

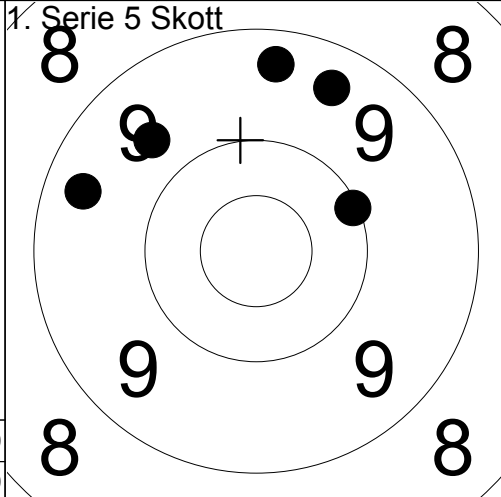

1:	9.4	↗
2:	10.1	→
3:	9.7	↖
4:	9.3	↑
5:	9.4	↖
Serie	46.0	
Total	46.0	

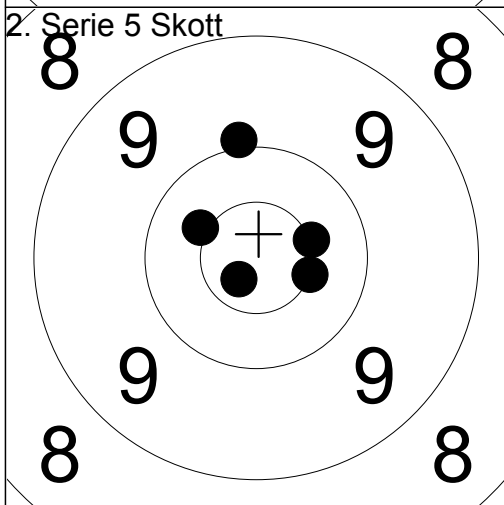

1:	10.7x	↙
2:	10.5x	→
3:	10.5x	→
4:	10.0	↑
5:	10.4x	↗
Serie	50.0	
Total	96.0	

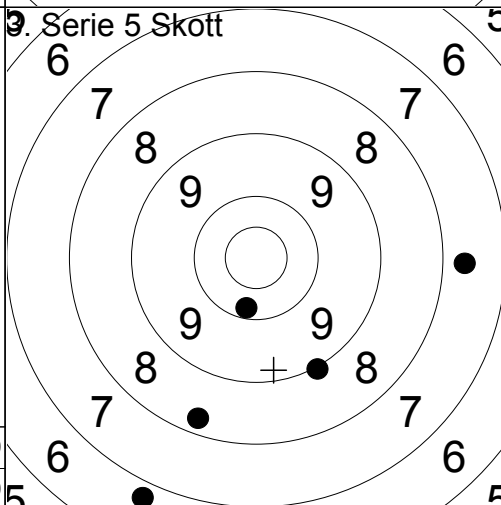

1:	9.0	↘
2:	7.7	→
3:	8.3	↘
4:	6.8	↘
5:	10.2	↘
Serie	40.0	
Total	136.0	

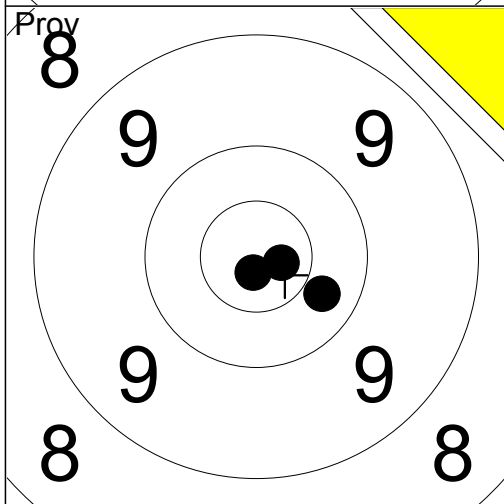

1:	10.7x	→
2:	10.3	↘
3:	10.8x	↘
Serie	30.0	
Total	136.0	

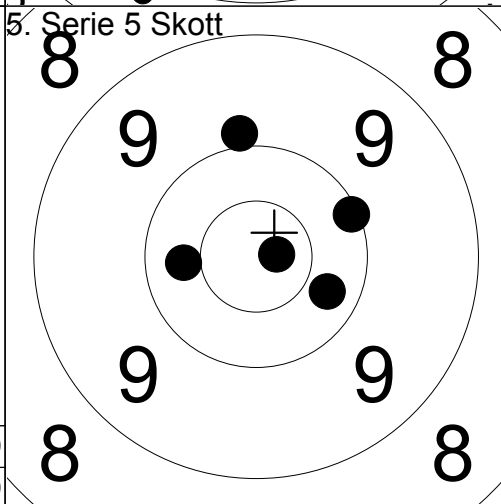

1:	9.9	↑
2:	10.8x	→
3:	10.1	→
4:	10.3	→
5:	10.3	↖
Serie	49.0	
Total	185.0	

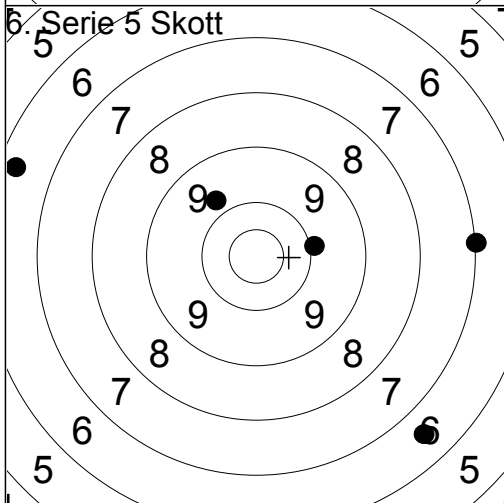

1:	10.0	→
2:	6.6	↘
3:	9.8	↗
4:	6.3	↑
5:	7.0	→
Serie	38.0	
Total	223.0	

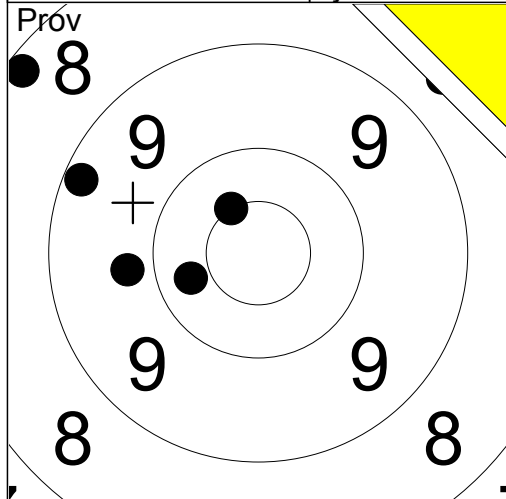

1:	9.2	↖
2:	8.2	↗
3:	10.3	↙
4:	9.8	↖
5:	10.5x	↗
Serie		46.0
Total		0.0

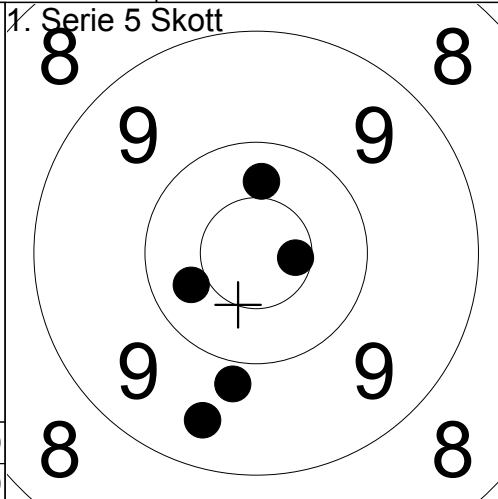

1:	10.6x	→
2:	9.8	↓
3:	10.3	↙
4:	9.5	↓
5:	10.4	↑
Serie		48.0
Total		48.0

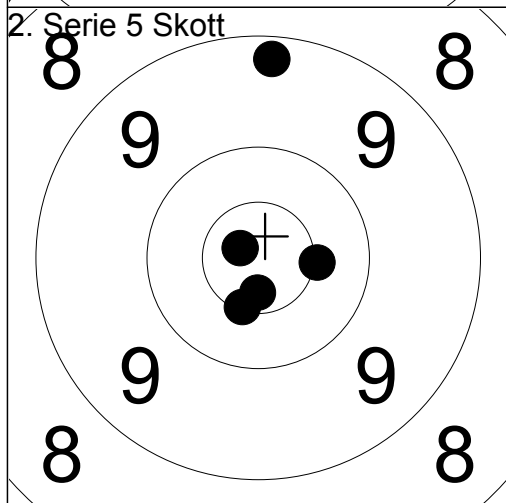

1:	10.7x	↓
2:	9.2	↑
3:	10.5x	→
4:	10.8x	↖
5:	10.5x	↓
Serie		49.0
Total		97.0

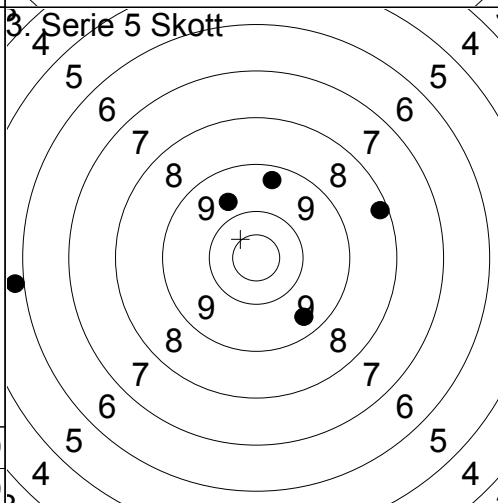

1:	8.2	→
2:	9.4	↓
3:	9.7	↗
4:	9.3	↑
5:	5.9	←
Serie		40.0
Total		137.0

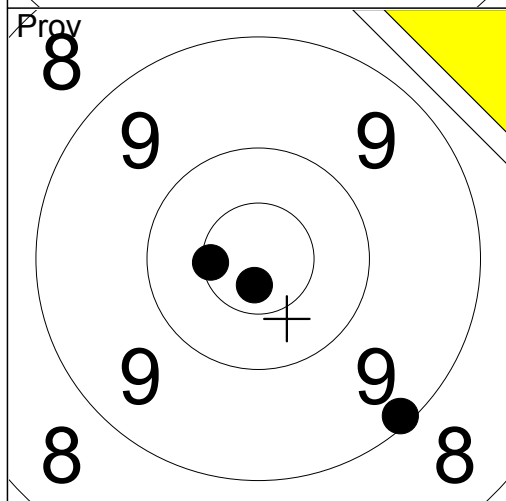

1:	9.1	↘
2:	10.7x	↓
3:	10.5x	←
Serie		29.0
Total		137.0

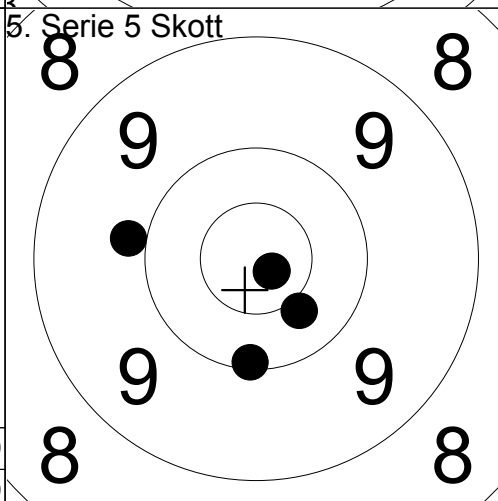

1:	10.8x	↘
2:	9.9	←
3:	10.4	↘
4:	10.8x	↘
5:	10.1	↓
Serie		49.0
Total		186.0

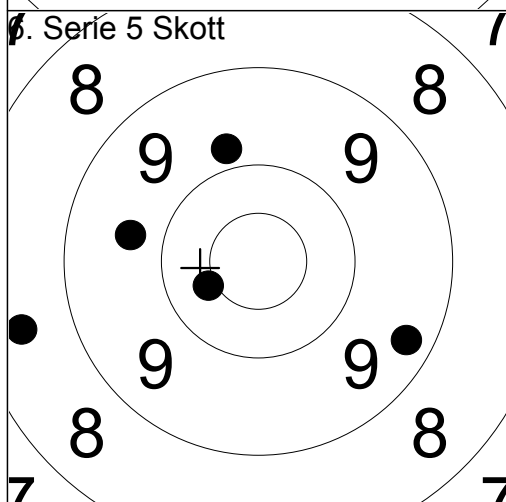

1:	9.8	↑
2:	9.3	↘
3:	10.4x	↙
4:	9.7	←
5:	8.5	←
Serie		45.0
Total		231.0

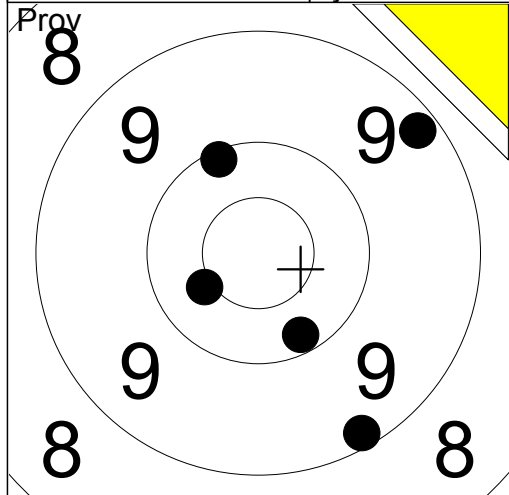

1:	9.2	↗
2:	10.1	↗
3:	10.2	↘
4:	9.2	↘
5:	10.4x	↙
Serie		48.0
Total		0.0

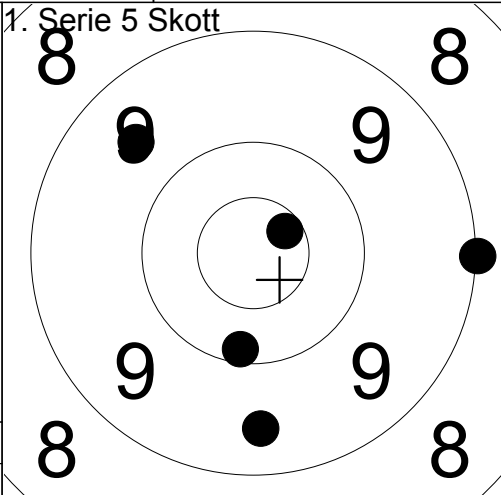

1:	9.6	↗
2:	9.0	→
3:	10.6x	↗
4:	9.4	↓
5:	10.1	↓
Serie		47.0
Total		47.0

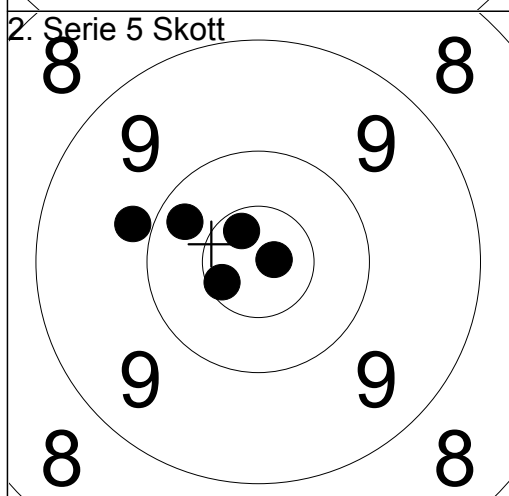

1:	10.3	↖
2:	10.7x	↗
3:	10.8x	→
4:	10.6x	↖
5:	9.8	↖
Serie		49.0
Total		96.0

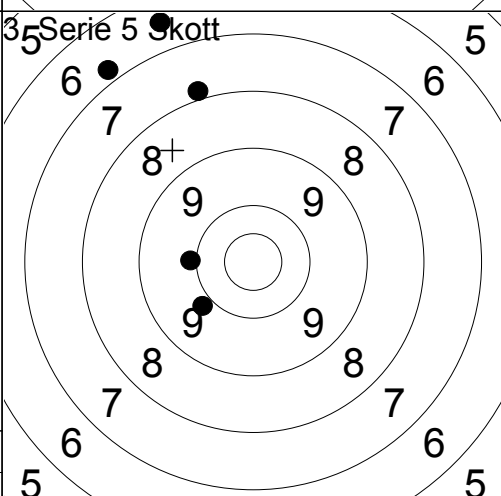

1:	7.9	↑
2:	9.9	←
3:	9.9	↖
4:	6.8	↗
5:	6.5	↗
Serie		37.0
Total		133.0

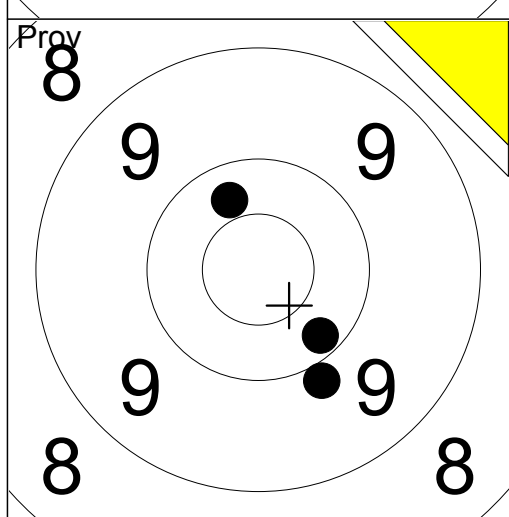

1:	10.2	↘
2:	9.9	↘
3:	10.3	↗
Serie		29.0
Total		133.0

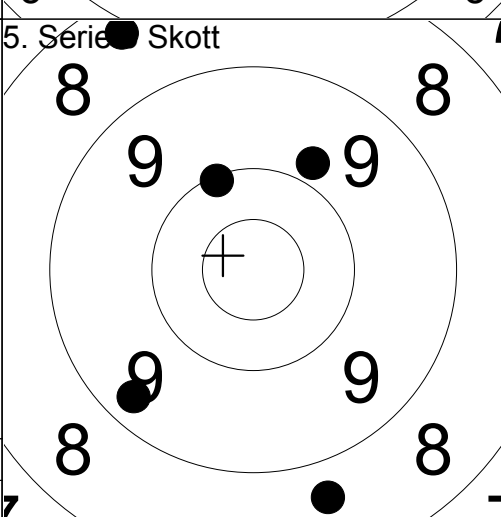

1:	8.4	↗
2:	8.7	↓
3:	9.8	↗
4:	10.1	↗
5:	9.3	↘
Serie		44.0
Total		177.0

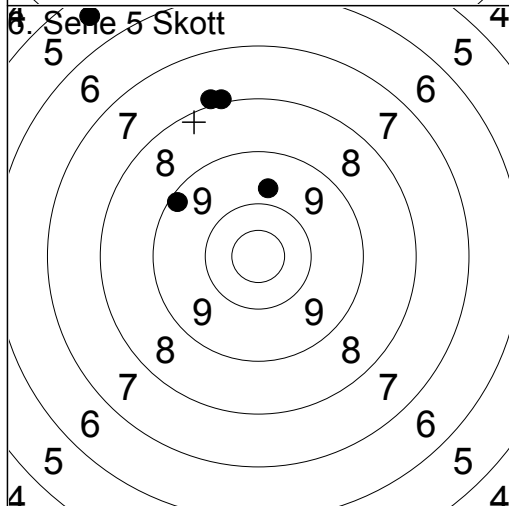

1:	8.0	↑
2:	9.2	↗
3:	9.7	↑
4:	7.9	↗
5:	5.5	↗
Serie		38.0
Total		215.0

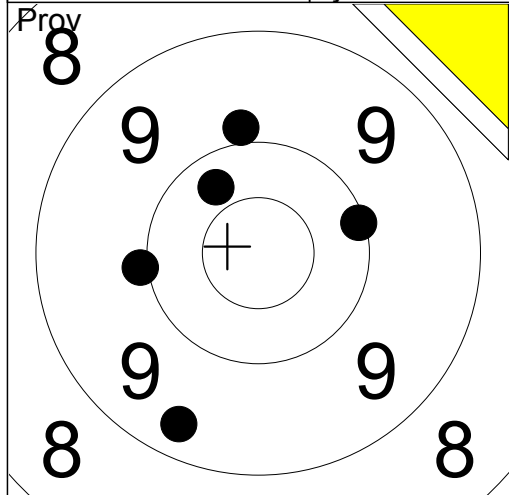

1:	10.3	↖
2:	10.1	→
3:	9.3	↙
4:	10.0	←
5:	9.9	↑

Serie	48.0
Total	0.0

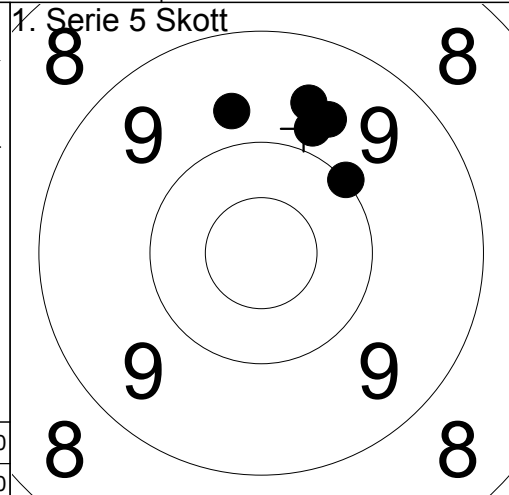

1:	9.7	↗
2:	9.7	↑
3:	9.8	↗
4:	9.6	↑
5:	10.0	↗

Serie	46.0
Total	46.0

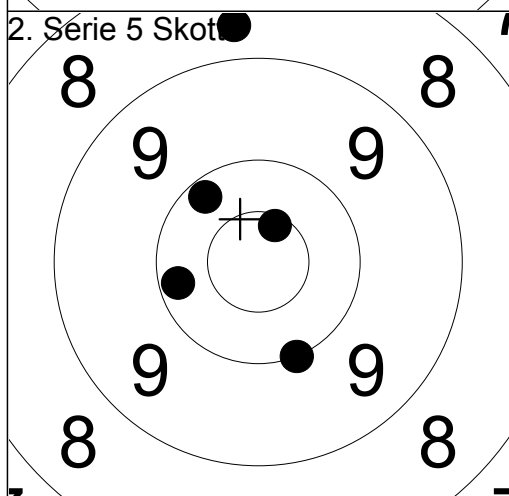

1:	10.2	↖
2:	8.7	↑
3:	10.2	←
4:	10.6x	↗
5:	10.0	↘

Serie	48.0
Total	94.0

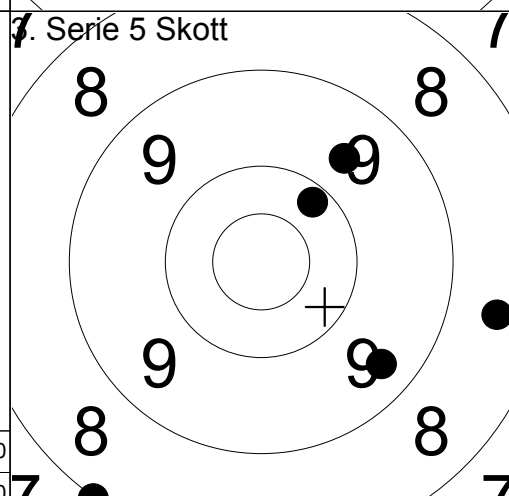

1:	9.4	↘
2:	9.6	↗
3:	10.2	↗
4:	8.5	→
5:	8.0	↙

Serie	44.0
Total	138.0

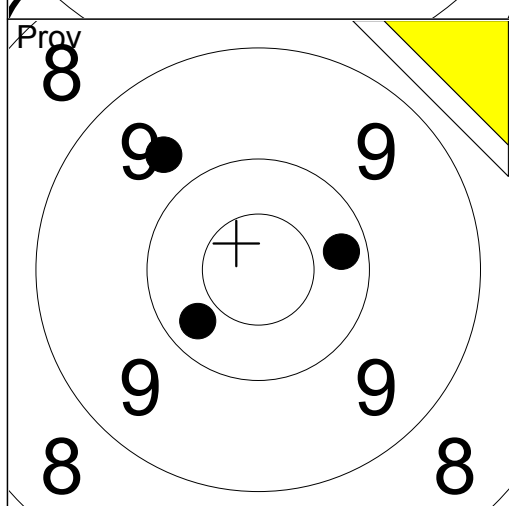

1:	10.3	↙
2:	9.7	↗
3:	10.2	→

Serie	29.0
Total	138.0

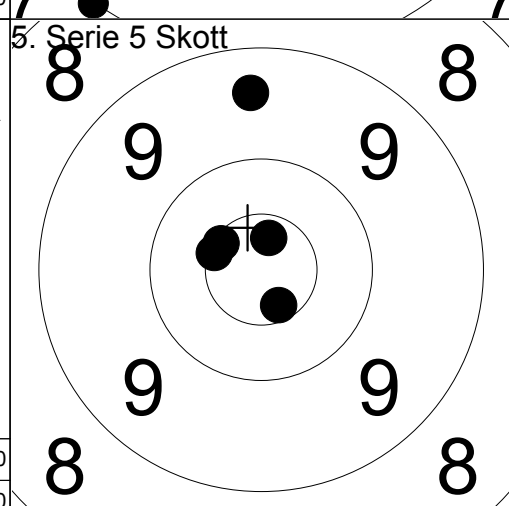

1:	9.4	↑
2:	10.6x	↘
3:	10.5x	←
4:	10.6x	←
5:	10.7x	↑

Serie	49.0
Total	187.0

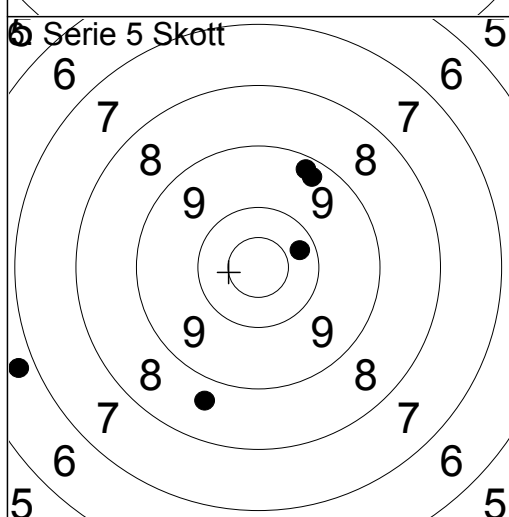

1:	9.2	↗
2:	10.3	→
3:	9.3	↗
4:	6.8	←
5:	8.7	↘

Serie	42.0
Total	229.0

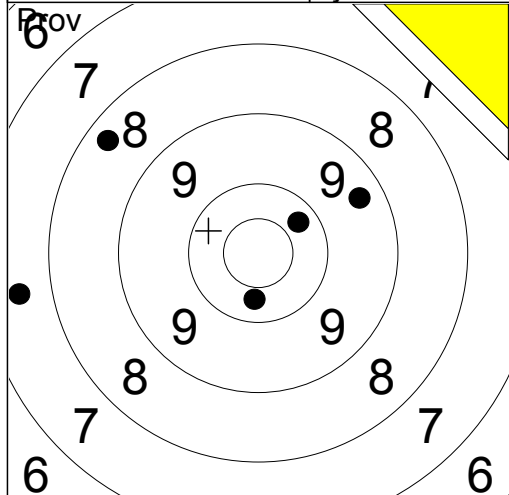

1. Serie 5 Skott

1:	10.3	↗
2:	7.6	←
3:	10.3	↓
4:	8.3	↗
5:	9.4	↘
Serie	44.0	
Total	0.0	

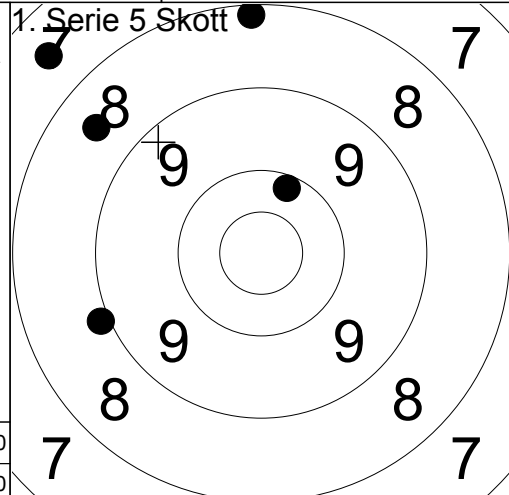

1. Serie 5 Skott

1:	8.2	↑
2:	7.5	↖
3:	10.2	↗
4:	8.9	←
5:	8.5	↖
Serie	41.0	
Total	41.0	

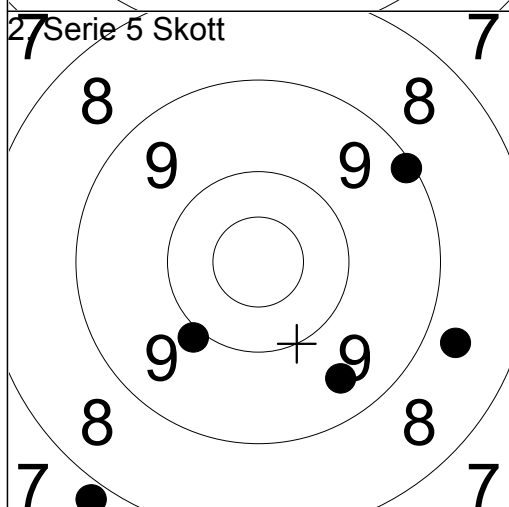

2. Serie 5 Skott

1:	9.1	↗
2:	9.5	↘
3:	8.7	↘
4:	7.8	↘
5:	9.9	↘
Serie	42.0	
Total	83.0	

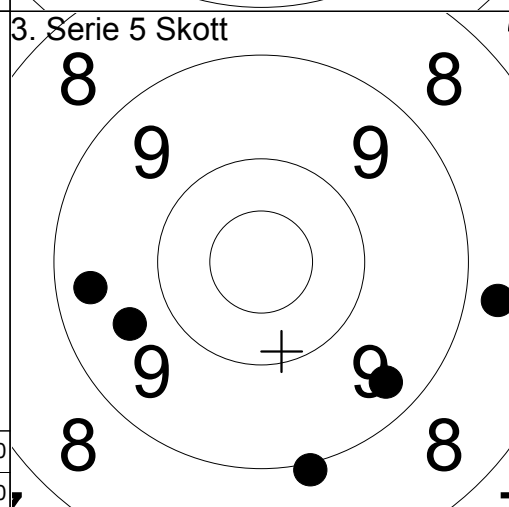

3. Serie 5 Skott

1:	8.7	→
2:	9.4	←
3:	9.4	↘
4:	9.6	←
5:	9.0	↓
Serie	44.0	
Total	127.0	

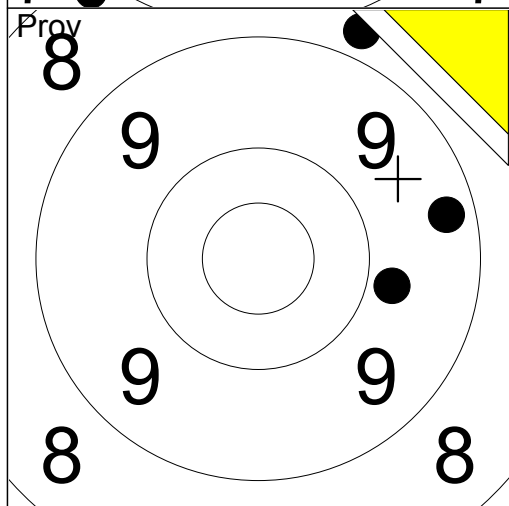

4. Serie 5 Skott

1:	9.8	→
2:	8.8	↑
3:	9.3	→
Serie	26.0	
Total	127.0	

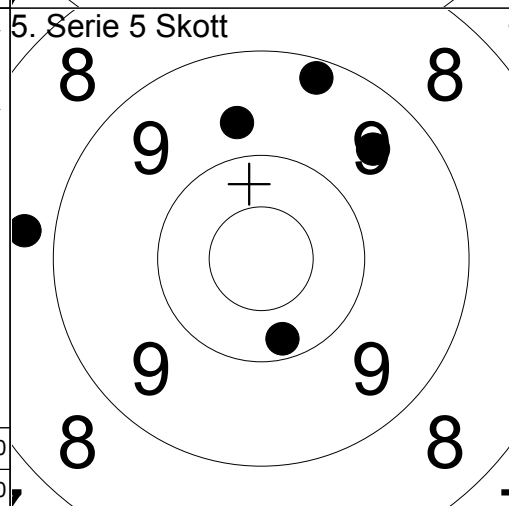

5. Serie 5 Skott

1:	9.2	↑
2:	8.7	←
3:	10.2	↓
4:	9.5	↗
5:	9.7	↑
Serie	45.0	
Total	172.0	

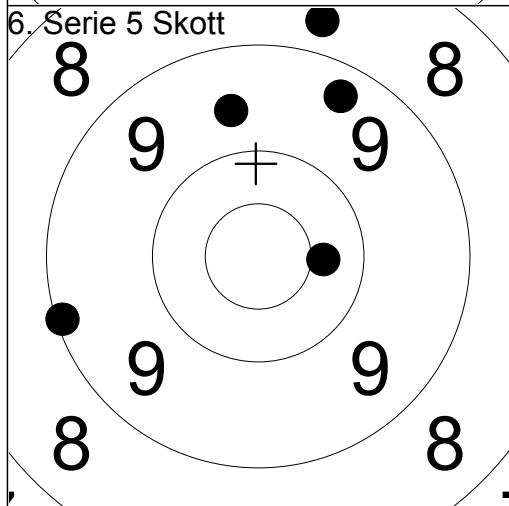

6. Serie 5 Skott

1:	9.3	↗
2:	8.7	↑
3:	9.6	↑
4:	9.1	←
5:	10.4	→
Serie	45.0	
Total	217.0	

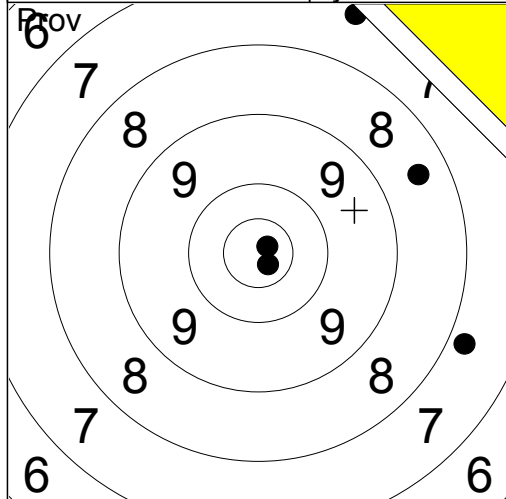

1:	7.8	⇒
2:	8.5	⇒
3:	10.8x	↗
4:	10.8x	⇩
5:	7.3	↗

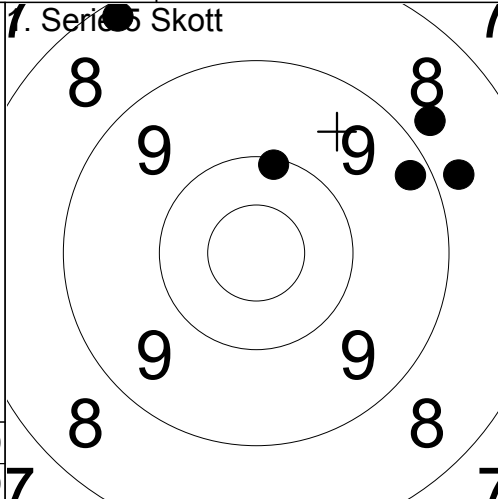

1:	8.8	↗
2:	9.2	↗
3:	8.2	↖
4:	10.1	↑
5:	8.8	⇒

Serie	42.0
Total	0.0

Serie	43.0
Total	43.0

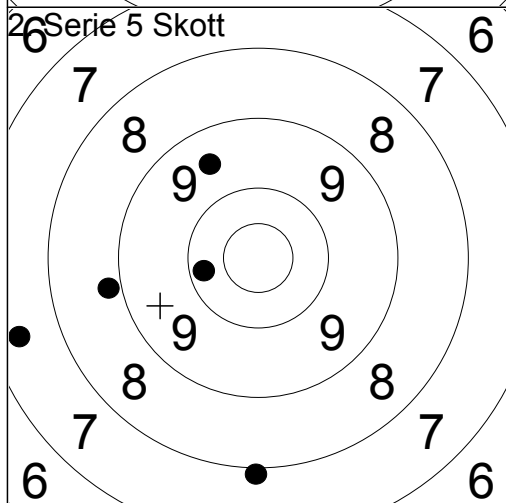

1:	9.5	↖
2:	8.8	⇐
3:	7.4	⇐
4:	7.9	⇩
5:	10.2	⇐

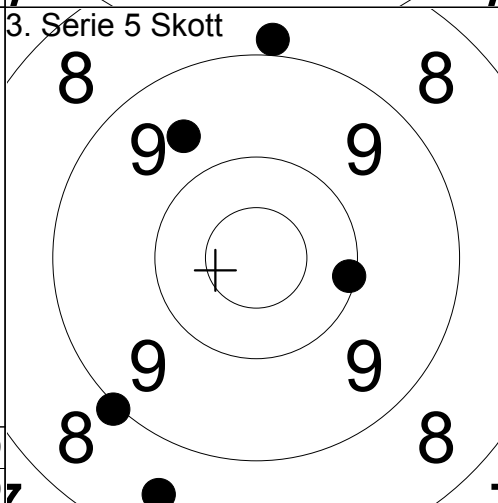

1:	10.1	⇒
2:	9.0	↘
3:	8.5	↘
4:	9.6	↗
5:	8.9	↑

Serie	41.0
Total	84.0

Serie	44.0
Total	128.0

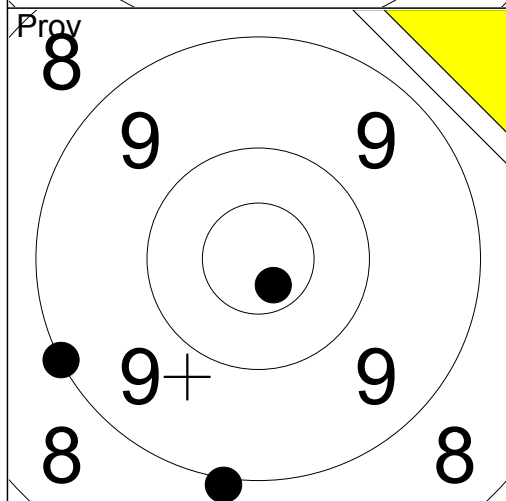

1:	10.7x	⇩
2:	9.0	⇩
3:	9.0	⇐

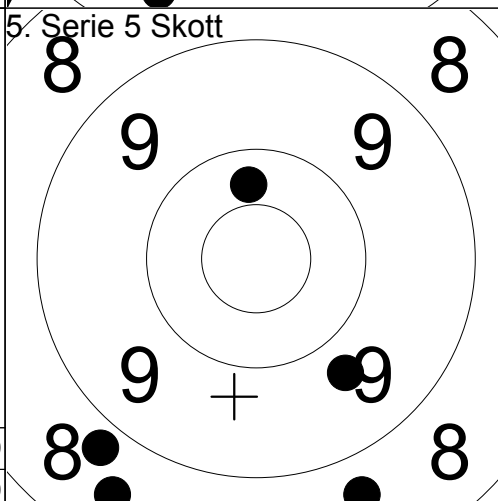

1:	8.5	↘
2:	9.7	⇩
3:	8.8	↘
4:	8.7	⇩
5:	10.3	↑

Serie	28.0
Total	128.0

Serie	43.0
Total	171.0

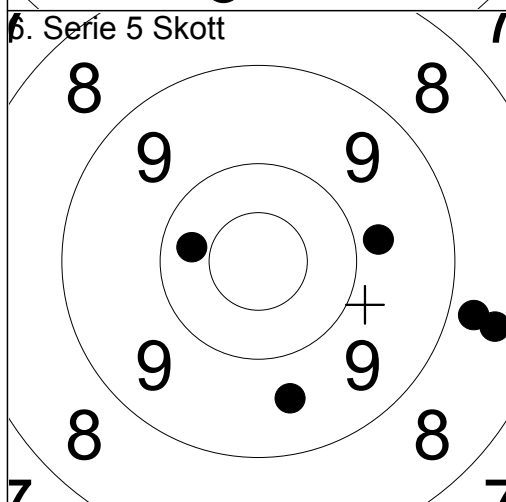

1:	9.6	⇩
2:	8.5	⇒
3:	8.8	⇒
4:	9.8	⇒
5:	10.3	⇐

Serie	44.0
Total	215.0

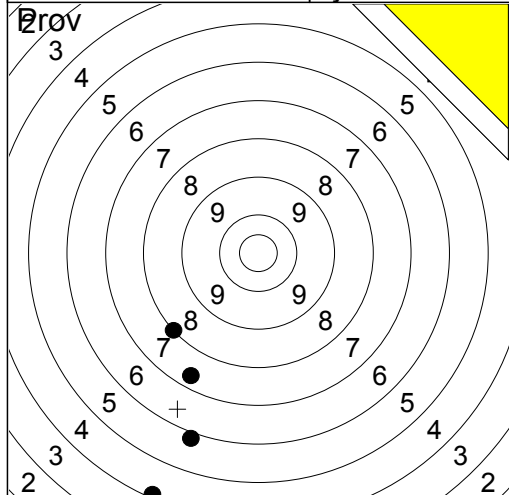

1:	7.4	↘
2:	4.1	↘
3:	5.9	↘
4:	8.0	↘

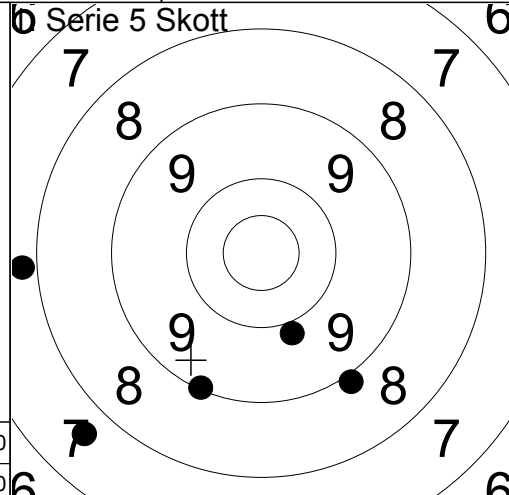

1:	9.9	↘
2:	7.7	↘
3:	9.1	↘
4:	7.8	←
5:	8.9	↘

Serie	24.0
Total	0.0

Serie	40.0
Total	40.0

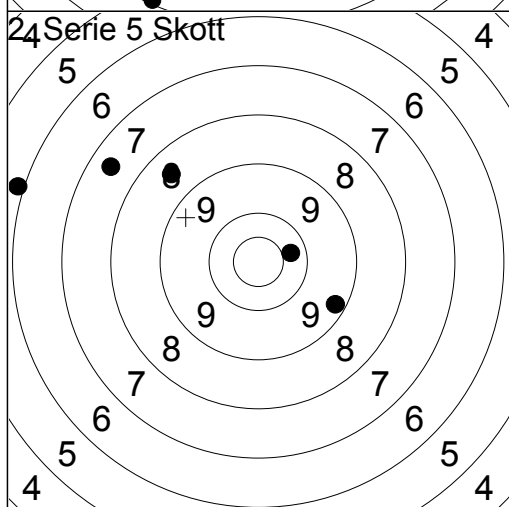

1:	7.5	↗
2:	8.5	↗
3:	10.3	→
4:	5.9	↖
5:	9.2	↘

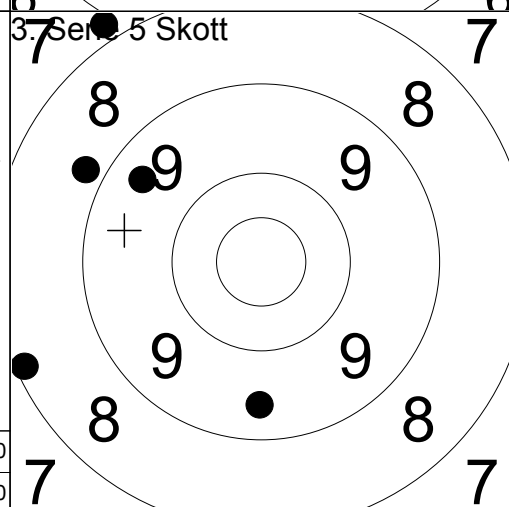

1:	7.8	↗
2:	8.8	↗
3:	9.4	↗
4:	9.4	↓
5:	8.1	↖

Serie	39.0
Total	79.0

Serie	41.0
Total	120.0

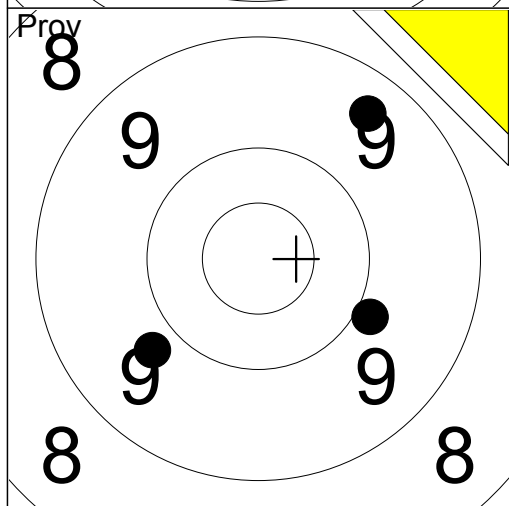

1:	9.8	↖
2:	9.9	↗
3:	9.4	↗

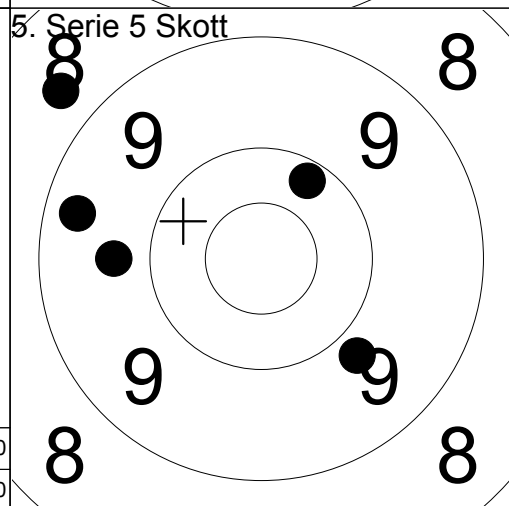

1:	9.7	←
2:	10.2	↗
3:	8.7	↗
4:	9.3	↖
5:	9.8	↘

Serie	27.0
Total	120.0

Serie	45.0
Total	165.0

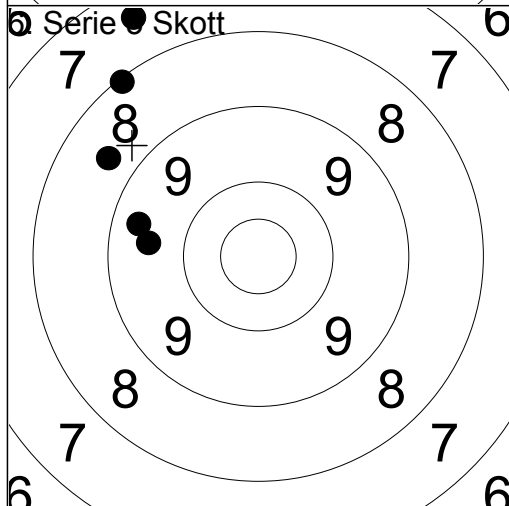

1:	8.1	↗
2:	9.6	←
3:	8.7	↗
4:	7.5	↗
5:	9.4	↖

Serie	41.0
Total	206.0

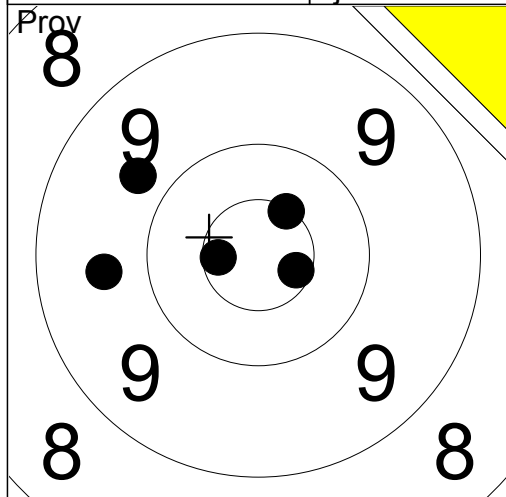

1:	9.7	↖
2:	10.5x	↗
3:	9.6	←
4:	10.6x	→
5:	10.6x	←

Serie	48.0
Total	0.0

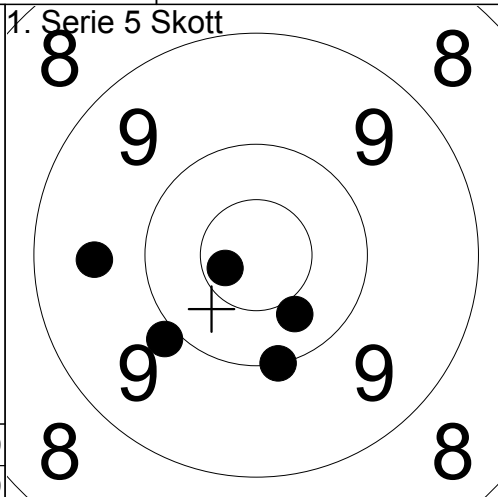

1:	10.4	↘
2:	9.6	←
3:	10.7x	←
4:	10.0	↘
5:	9.9	↘

Serie	48.0
Total	48.0

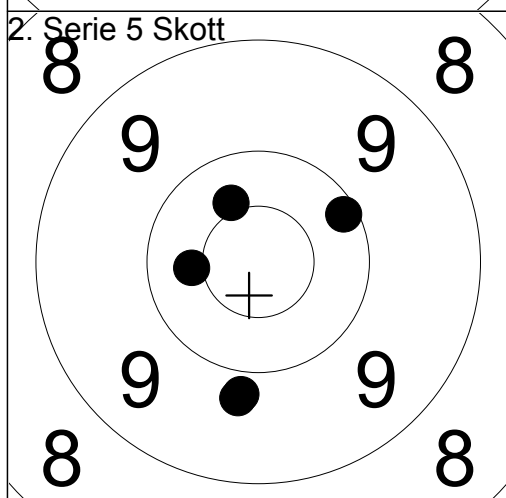

1:	10.4	↖
2:	9.8	↘
3:	10.4	←
4:	9.8	↘
5:	10.1	↗

Serie	48.0
Total	96.0

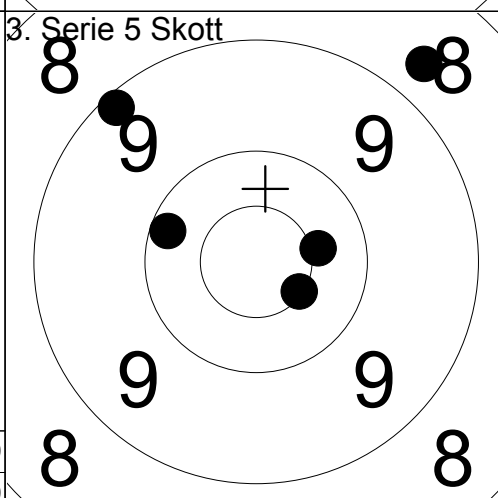

1:	8.7	↗
2:	9.2	↗
3:	10.2	←
4:	10.5x	↘
5:	10.4x	→

Serie	47.0
Total	143.0

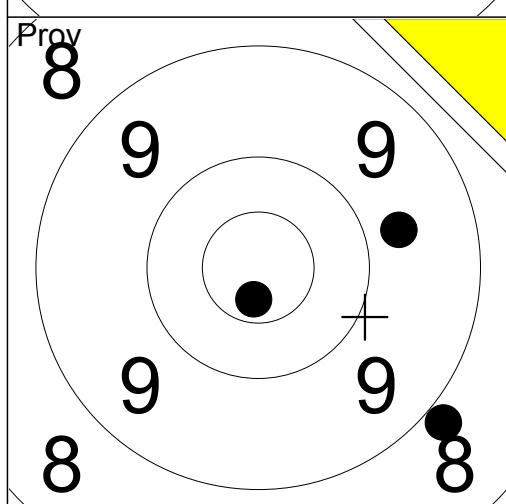

1:	8.9	↘
2:	9.7	→
3:	10.7x	↘

Serie	27.0
Total	143.0

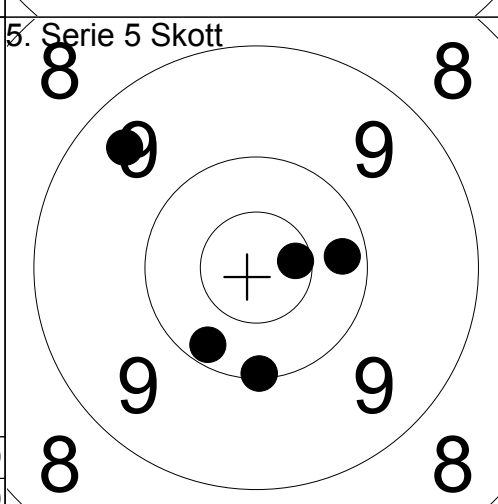

1:	9.4	↖
2:	10.2	↘
3:	10.2	→
4:	10.6x	→
5:	10.1	↘

Serie	49.0
Total	192.0

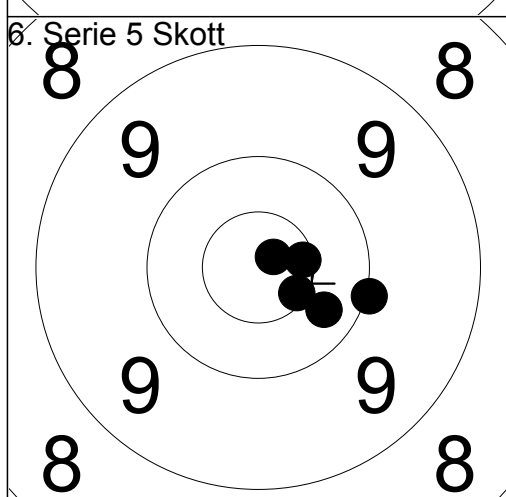

1:	10.8x	↗
2:	10.3	↘
3:	10.6x	→
4:	10.0	→
5:	10.6x	↘

Serie	50.0
Total	242.0

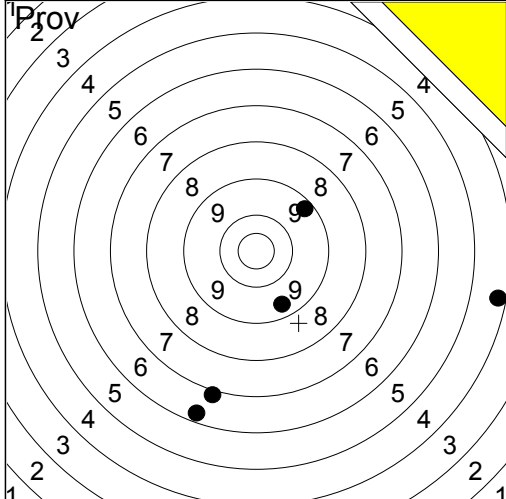

1: 6.3 ↘
 2: 6.9 ↘
 3: 9.4 ↘
 4: 9.3 ↗
 5: 4.3 →

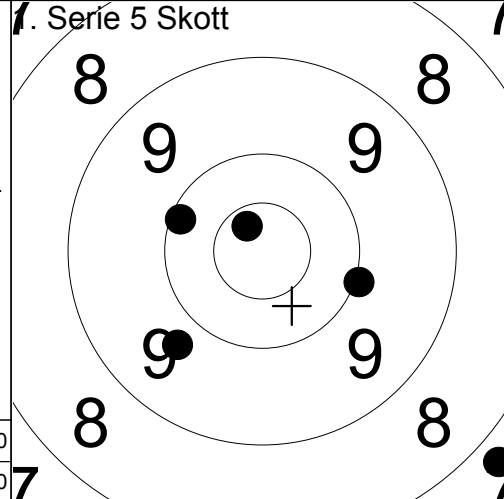

1: 7.8 ↘
 2: 10.0 →
 3: 10.7x ↗
 4: 9.7 ↘
 5: 10.1 ↖

Serie 34.0
 Total 0.0

Serie 46.0
 Total 46.0

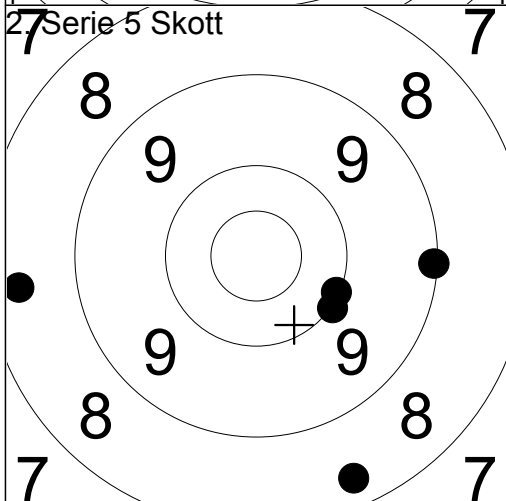

1: 8.4 ↘
 2: 10.0 →
 3: 9.1 →
 4: 8.4 ←
 5: 10.0 ↘

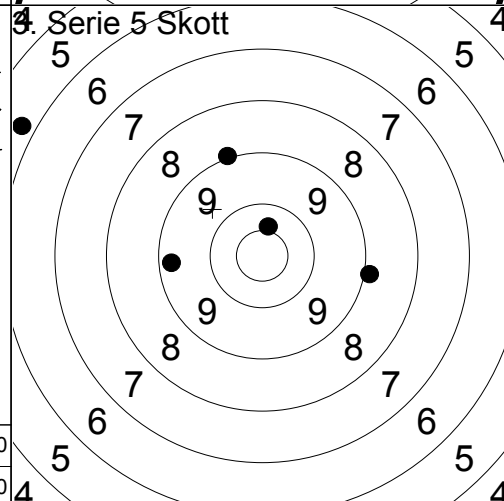

1: 10.4 ↑
 2: 8.9 →
 3: 5.8 ↗
 4: 9.3 ←
 5: 9.0 ↗

Serie 45.0
 Total 91.0

Serie 41.0
 Total 132.0

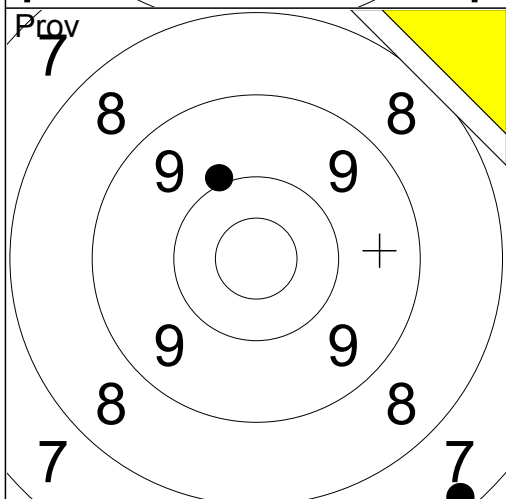

1: 9.9 ↗
 2: 7.7 ↗
 3: 7.2 ↘

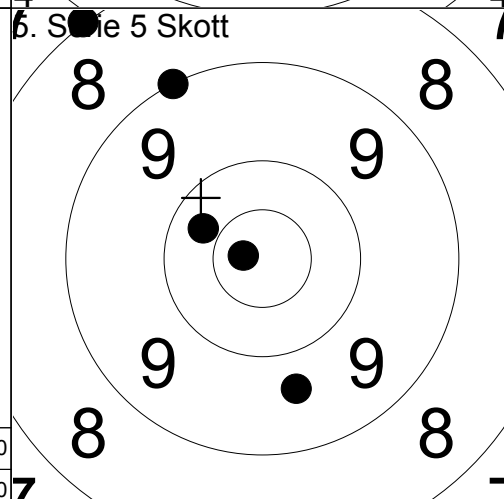

1: 10.8x ←
 2: 9.7 ↘
 3: 9.0 ↗
 4: 10.3 ↗
 5: 8.0 ↗

Serie 23.0
 Total 132.0

Serie 46.0
 Total 178.0

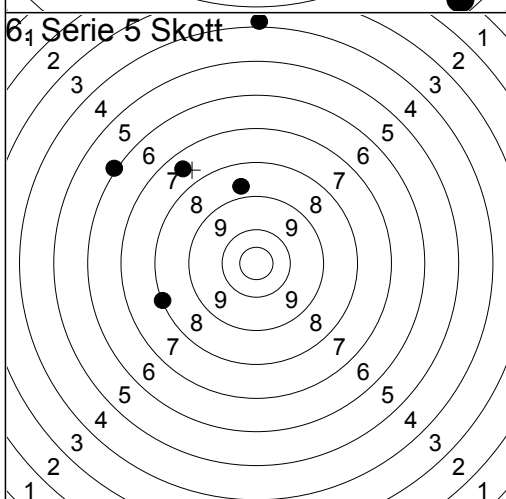

1: 8.0 ←
 2: 6.0 ↖
 3: 8.7 ↑
 4: 3.9 ↑
 5: 7.5 ↗

Serie 32.0
 Total 210.0

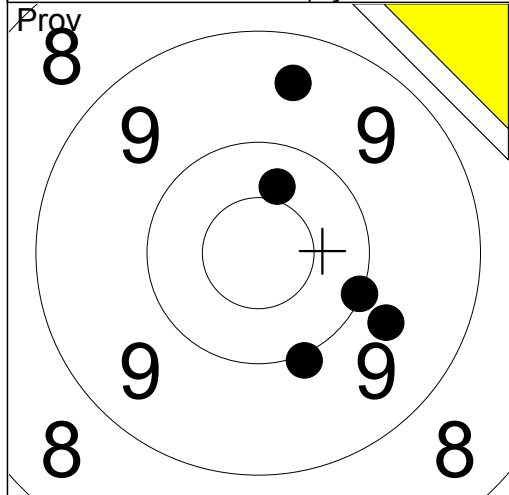

1:	9.5	↑
2:	10.0	→
3:	9.7	→
4:	10.0	↓
5:	10.4	↑

Serie	48.0
Total	0.0

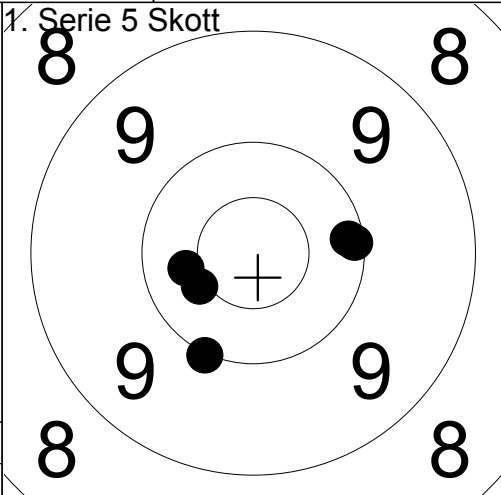

1:	10.1	→
2:	10.1	→
3:	10.4x	↙
4:	10.0	↓
5:	10.4	←

Serie	50.0
Total	50.0

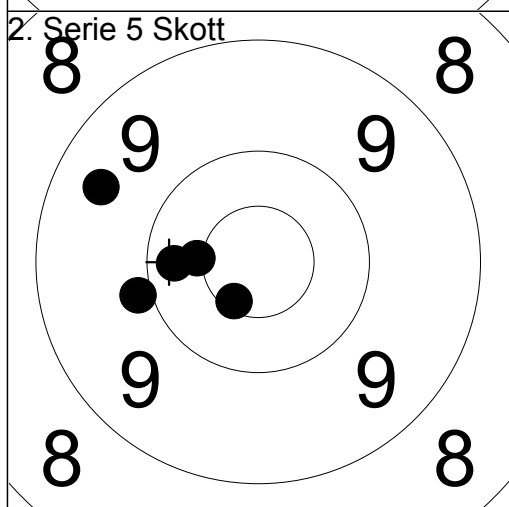

1:	10.3	←
2:	9.9	←
3:	10.4x	←
4:	10.6x	↙
5:	9.5	↑

Serie	48.0
Total	98.0

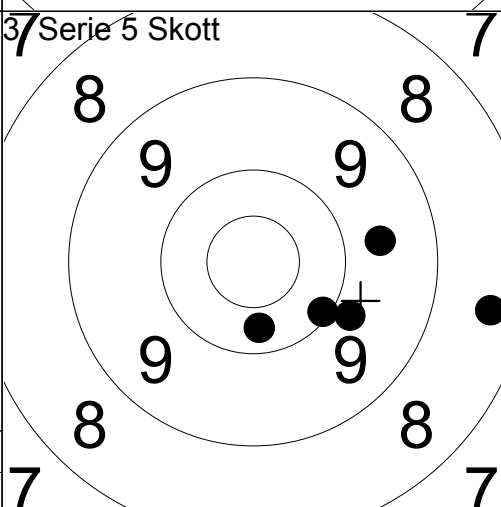

1:	10.3	↓
2:	9.6	→
3:	8.4	→
4:	10.1	↙
5:	9.8	↙

Serie	46.0
Total	144.0

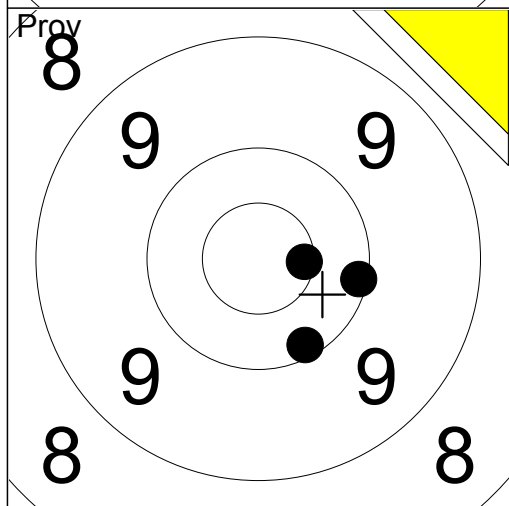

1:	10.1	→
2:	10.6x	→
3:	10.1	↓

Serie	30.0
Total	144.0

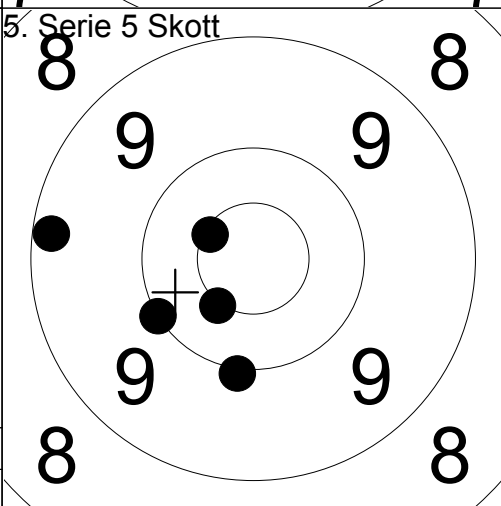

1:	9.2	←
2:	10.5x	↙
3:	10.5x	↖
4:	10.0	↙
5:	10.0	↓

Serie	49.0
Total	193.0

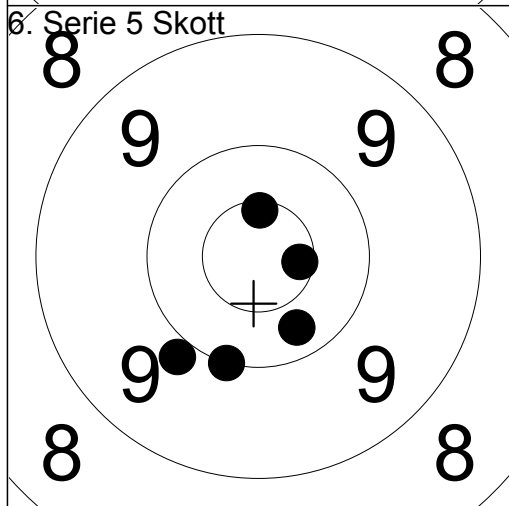

1:	10.6x	↑
2:	10.6x	→
3:	9.9	↙
4:	10.0	↓
5:	10.3	↙

Serie	49.0
Total	242.0

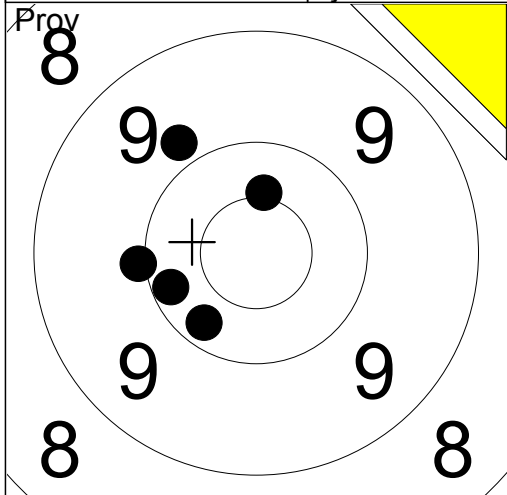

1. Serie 5 Skott

1:	10.4x	↑
2:	10.0	←
3:	10.2	↘
4:	9.8	↗
5:	10.2	←

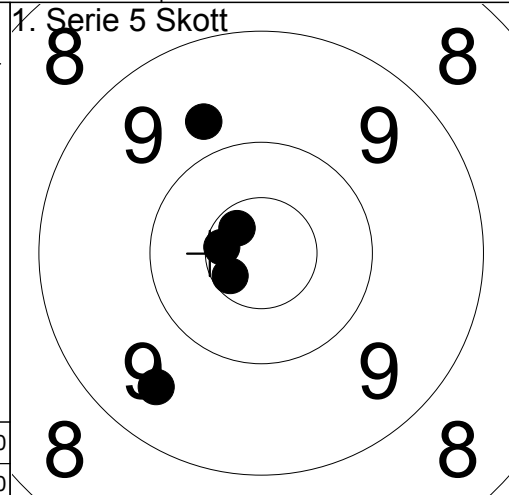

1:	9.7	↑
2:	10.7x	↗
3:	10.6x	←
4:	10.6x	↘
5:	9.5	↘

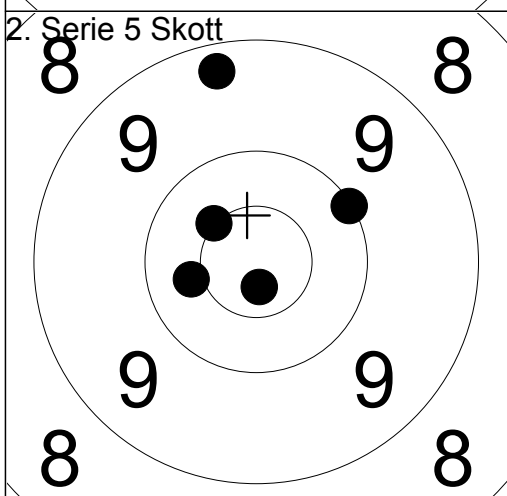

1:	9.3	↑
2:	10.5x	↗
3:	10.0	↗
4:	10.4	←
5:	10.7x	↓

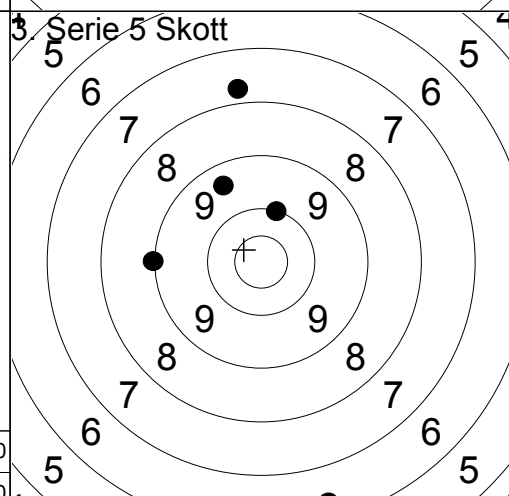

1:	10.0	↑
2:	9.0	←
3:	9.4	↑
4:	7.8	↑
5:	6.4	↓

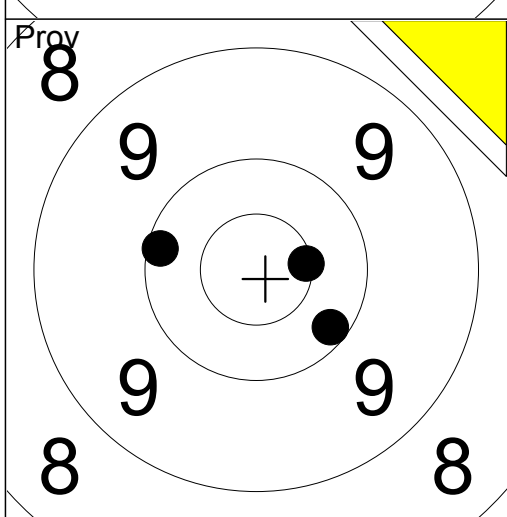

1:	10.1	←
2:	10.2	↘
3:	10.5x	→

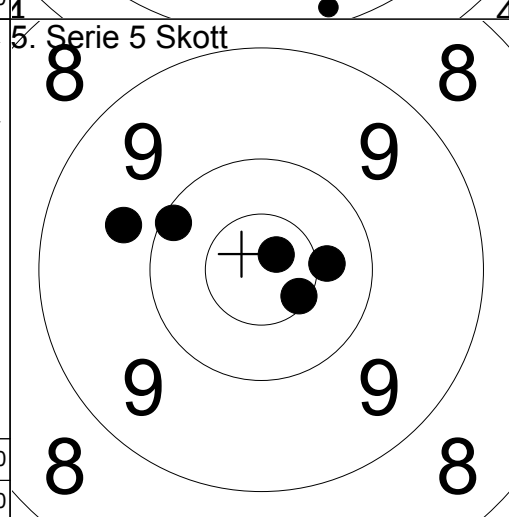

1:	10.1	↖
2:	9.7	←
3:	10.4	→
4:	10.6x	↘
5:	10.8x	↗

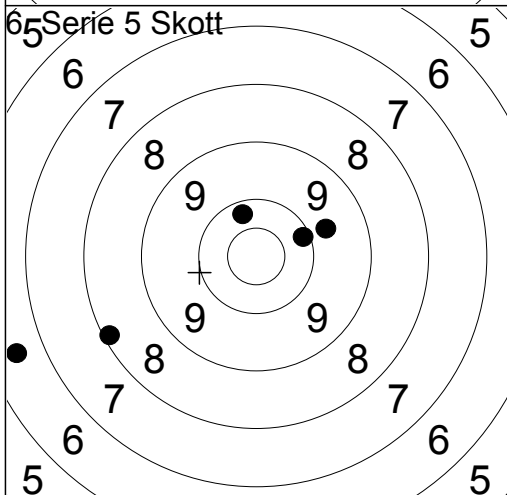

1:	9.7	→
2:	10.2	↑
3:	10.1	→
4:	8.1	←
5:	6.5	←

Serie	49.0
Total	187.0

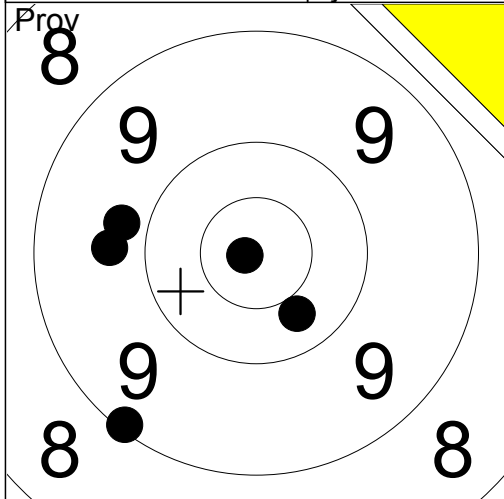

1:	10.3	↘
2:	9.1	↘
3:	10.9x	←
4:	9.7	←
5:	9.8	←

Serie	47.0
Total	0.0

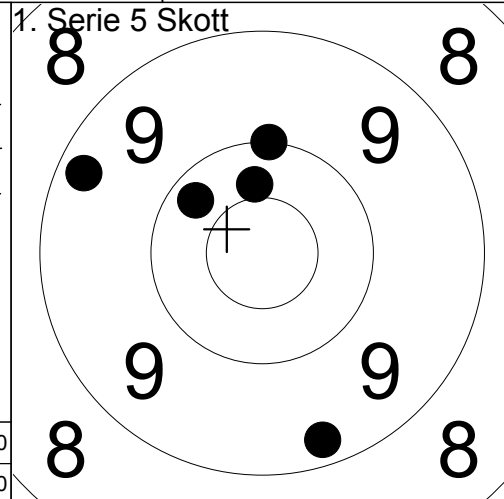

1:	10.2	↗
2:	10.4	↑
3:	10.0	↑
4:	9.3	↖
5:	9.3	↘

Serie	48.0
Total	48.0

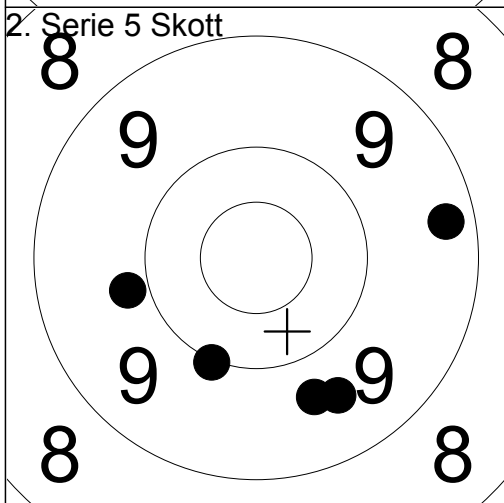

1:	9.3	→
2:	9.7	↘
3:	9.6	↘
4:	10.0	↘
5:	9.8	←

Serie	46.0
Total	94.0

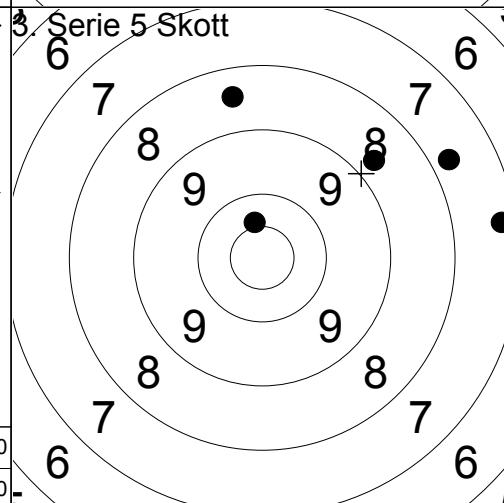

1:	7.7	↗
2:	8.5	↑
3:	10.4x	↑
4:	7.3	→
5:	8.7	↗

Serie	40.0
Total	134.0

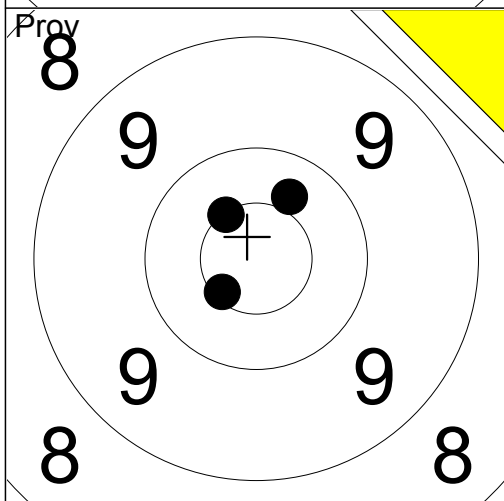

1:	10.6x	↘
2:	10.5x	↗
3:	10.4	↗

Serie	30.0
Total	134.0

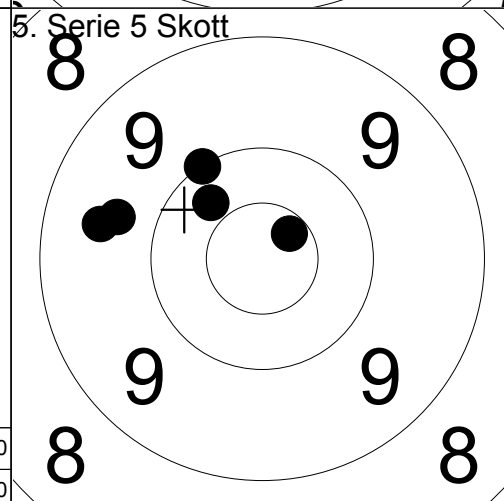

1:	10.3	↗
2:	10.0	↗
3:	9.7	↖
4:	9.5	↖
5:	10.6x	↗

Serie	48.0
Total	182.0

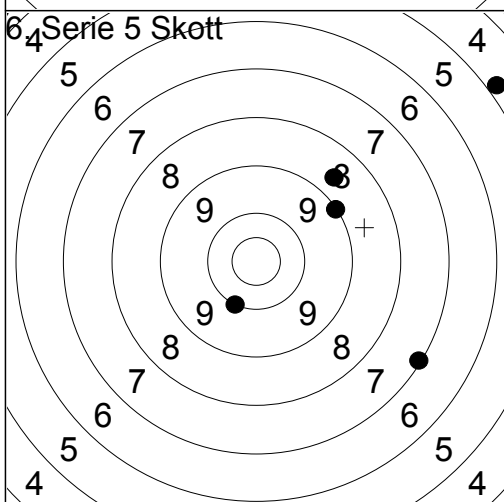

1:	10.0	↘
2:	8.7	↗
3:	9.1	↗
4:	7.1	↘
5:	4.8	↗

Serie	38.0
Total	220.0

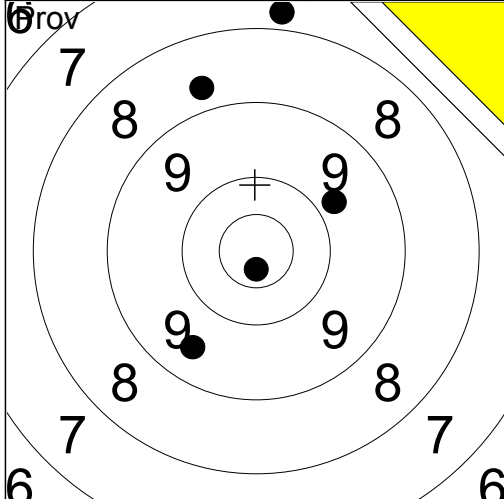

1:	8.7	↗
2:	7.8	↑
3:	9.5	↙
4:	9.8	↘
5:	10.7x	↓

Serie	43.0
Total	0.0

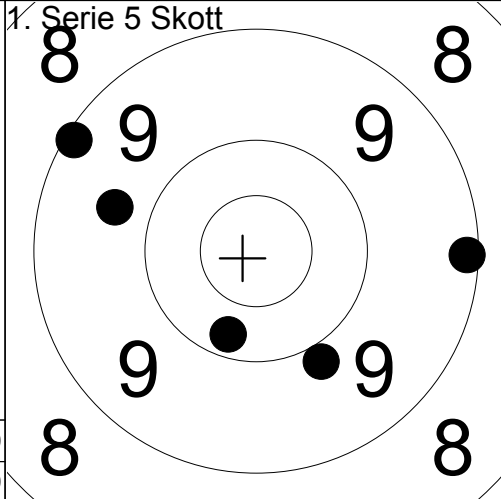

1:	10.2	↘
2:	9.7	↖
3:	9.1	↗
4:	9.1	→
5:	9.9	↙

Serie	46.0
Total	46.0

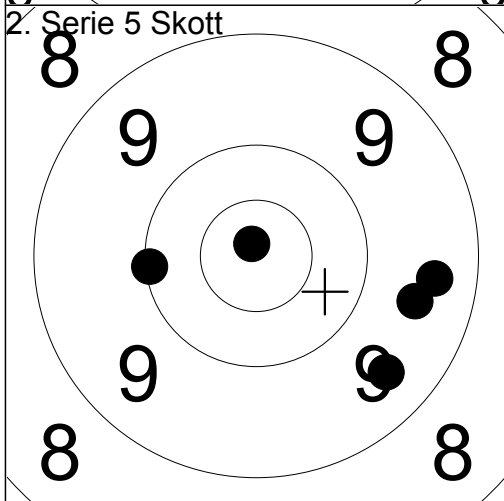

1:	9.4	→
2:	10.1	←
3:	9.5	↙
4:	9.5	↘
5:	10.8x	↗

Serie	47.0
Total	93.0

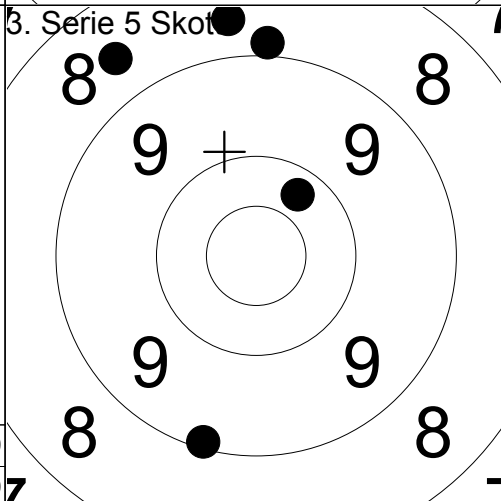

1:	8.6	↖
2:	8.9	↑
3:	9.1	↙
4:	10.3	↗
5:	8.6	↑

Serie	43.0
Total	136.0

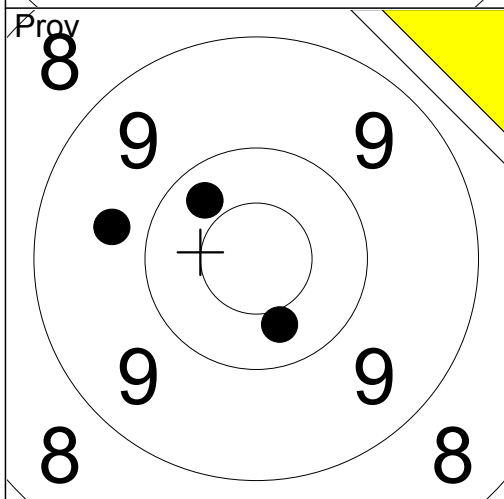

1:	10.4	↙
2:	9.7	↖
3:	10.3	↗

Serie	29.0
Total	136.0

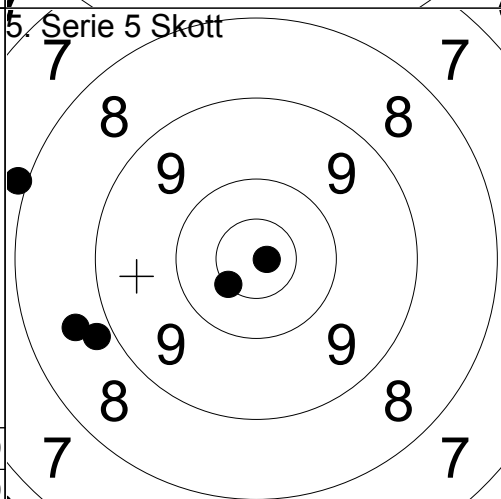

1:	8.6	↖
2:	7.9	↖
3:	10.5x	↙
4:	8.8	↖
5:	10.8x	→

Serie	43.0
Total	179.0

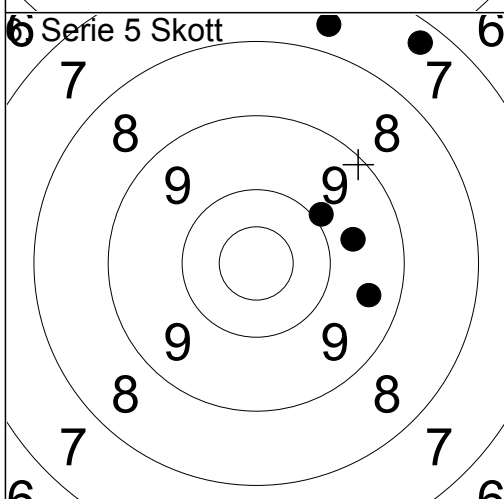

1:	9.9	↗
2:	9.4	↘
3:	9.7	→
4:	7.3	↗
5:	7.7	↑

Serie	41.0
Total	220.0

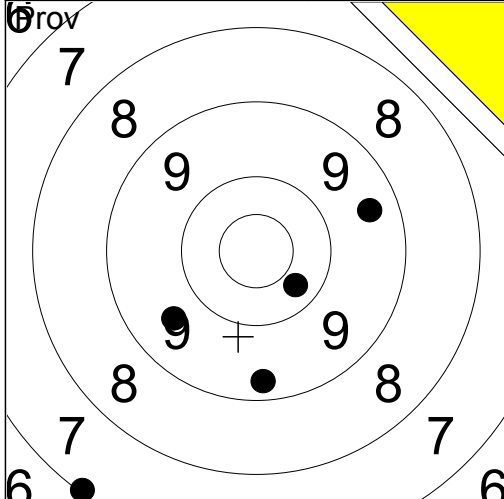

1:	7.1	↙
2:	9.6	↙
3:	10.3	↘
4:	9.3	↓
5:	9.4	→

Serie	44.0
Total	0.0

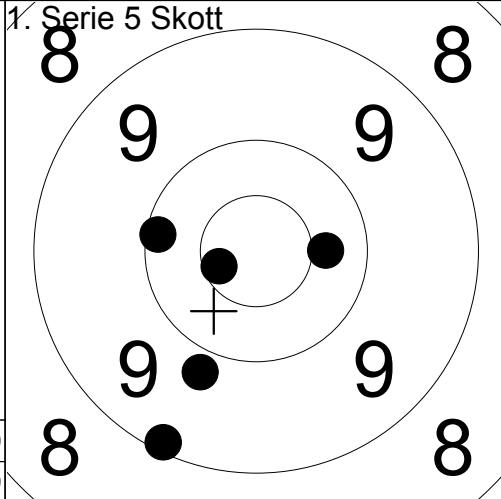

1:	9.1	↙
2:	9.8	↙
3:	10.4	→
4:	10.6x	↙
5:	10.1	↙

Serie	48.0
Total	48.0

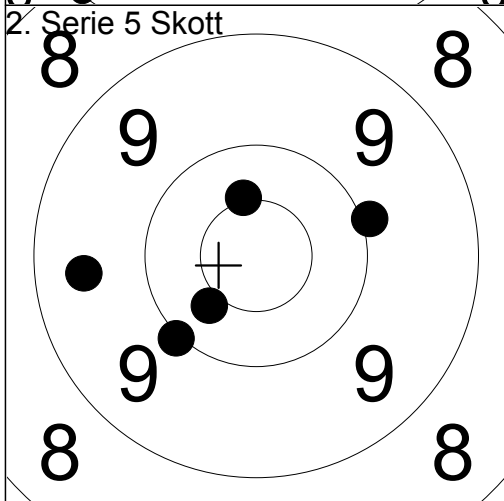

1:	9.5	←
2:	10.5x	↑
3:	10.0	→
4:	10.0	↙
5:	10.4	↙

Serie	49.0
Total	97.0

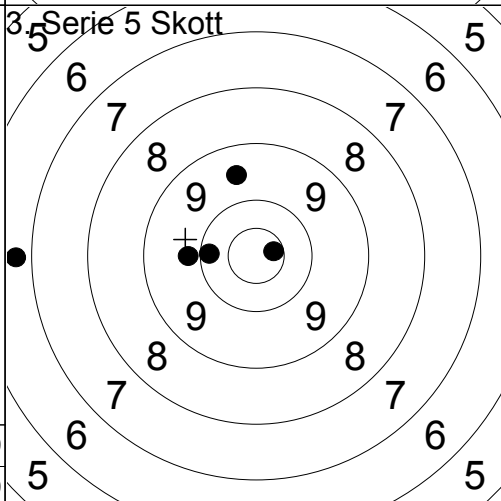

1:	10.7x	→
2:	10.2	←
3:	9.8	←
4:	9.6	↑
5:	6.8	←

Serie	44.0
Total	141.0

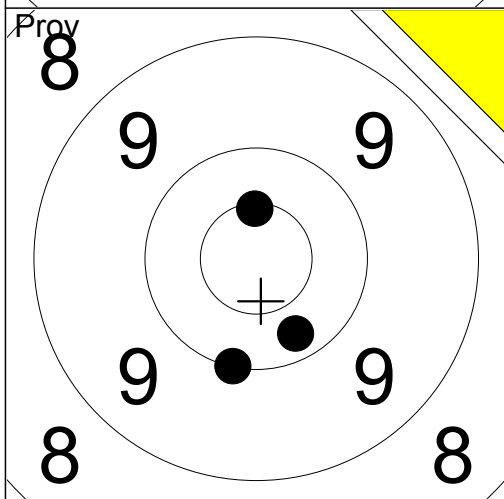

1:	10.5x	↑
2:	10.2	↘
3:	10.0	↘

Serie	30.0
Total	141.0

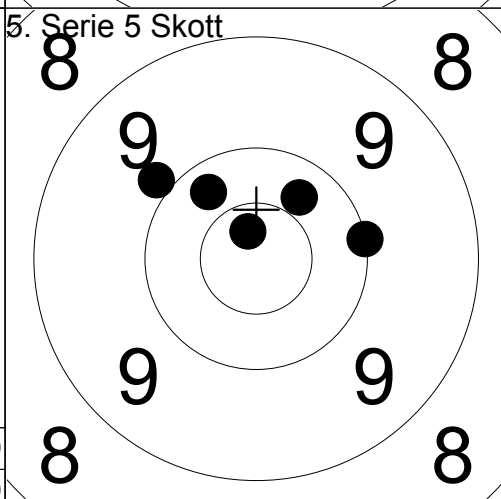

1:	10.7x	↑
2:	10.3	↗
3:	9.9	↗
4:	10.0	→
5:	10.3	↗

Serie	49.0
Total	190.0

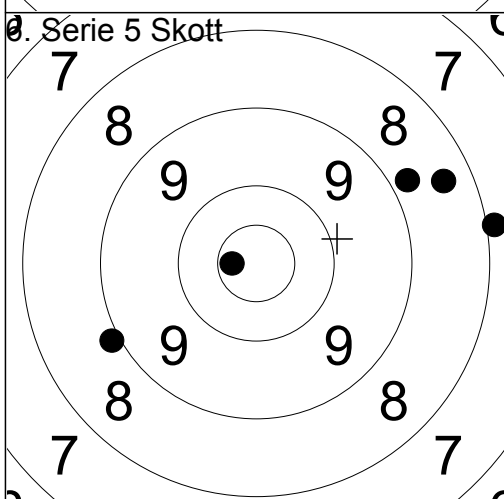

1:	10.7x	←
2:	8.8	↗
3:	7.9	→
4:	8.9	↙
5:	8.4	↗

Serie	41.0
Total	231.0

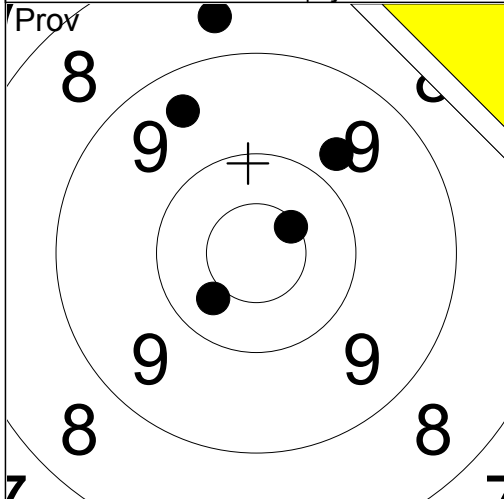

1:	8.6	↗
2:	9.4	↗
3:	10.5x	↗
4:	10.4	↘
5:	9.8	↗

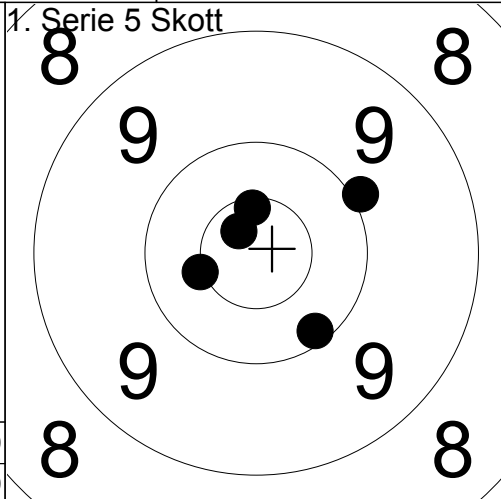

1:	10.7x	↖
2:	10.5x	←
3:	10.0	↗
4:	10.1	↘
5:	10.6x	↑

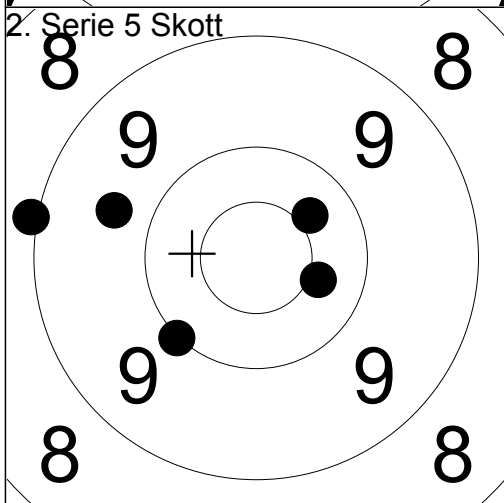

1:	9.0	←
2:	10.4	→
3:	10.4	↗
4:	9.7	←
5:	10.0	↘

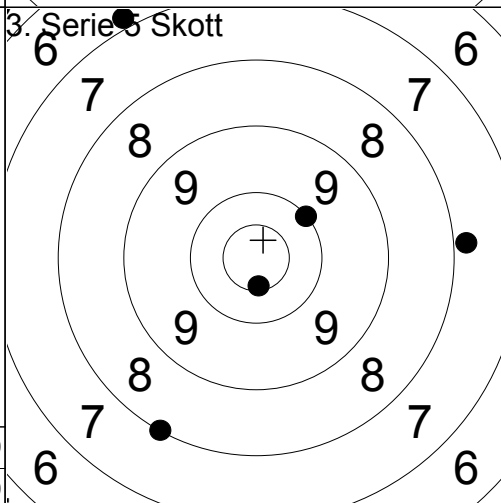

1:	7.8	→
2:	10.0	↗
3:	10.6x	↘
4:	6.9	↗
5:	8.0	↘

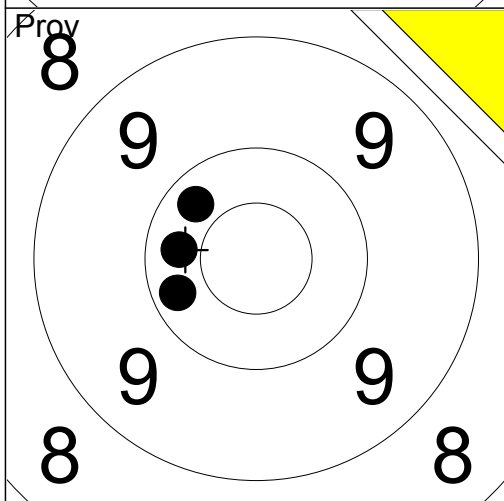

1:	10.3	←
2:	10.3	↗
3:	10.2	←

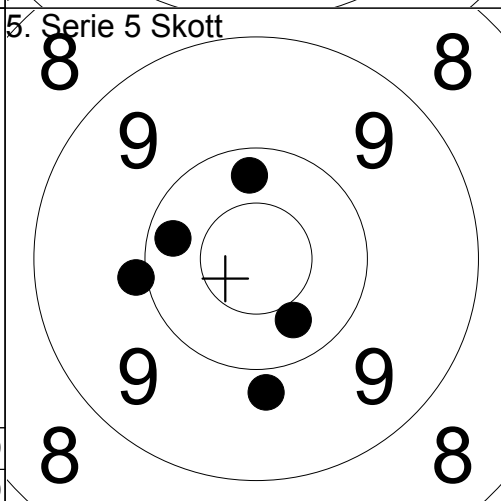

1:	10.2	←
2:	9.9	←
3:	9.8	↘
4:	10.3	↑
5:	10.4	↘

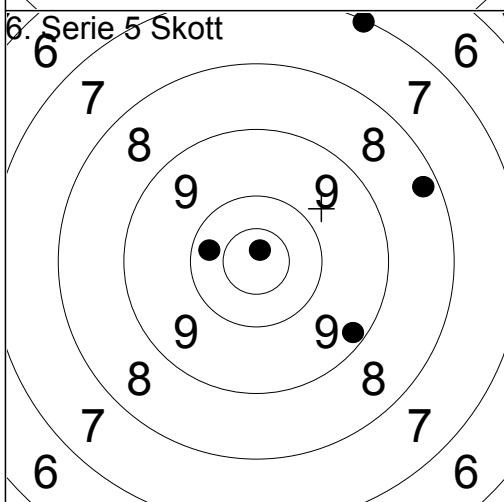

1:	8.3	→
2:	9.2	↘
3:	10.8x	↗
4:	7.1	↗
5:	10.3	←

Serie	44.0
Total	231.0

Serie	48.0
Total	187.0

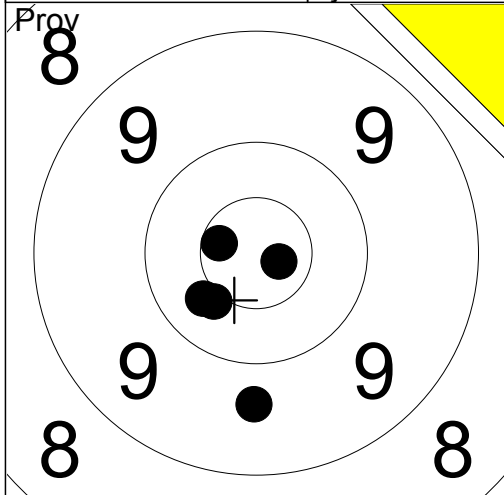

1:	10.4	↙
2:	10.6x	←
3:	10.7x	→
4:	10.4x	↙
5:	9.7	↓

Serie	49.0
Total	0.0

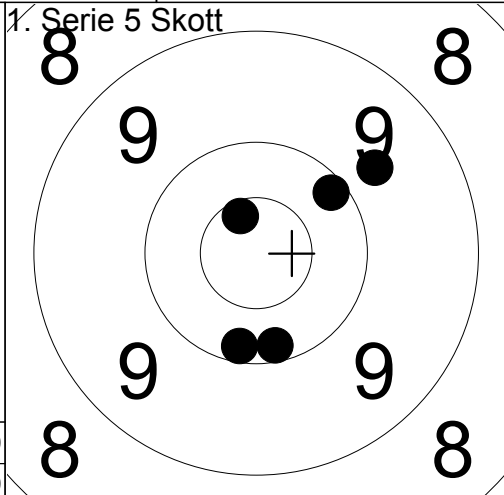

1:	10.2	↓
2:	10.1	↗
3:	10.6x	↗
4:	10.2	↓
5:	9.7	↗

Serie	49.0
Total	49.0

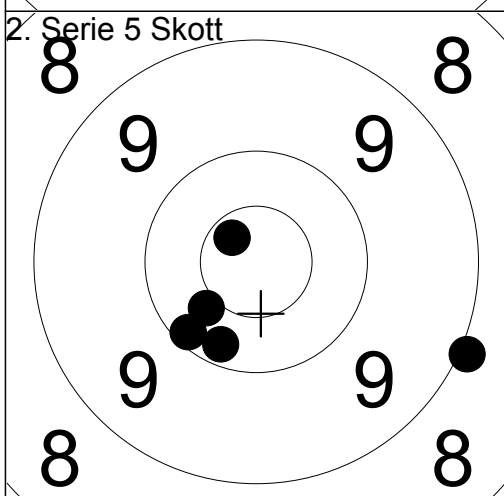

1:	10.4	↙
2:	10.1	↙
3:	9.0	→
4:	10.2	↙
5:	10.7x	↗

Serie	49.0
Total	98.0

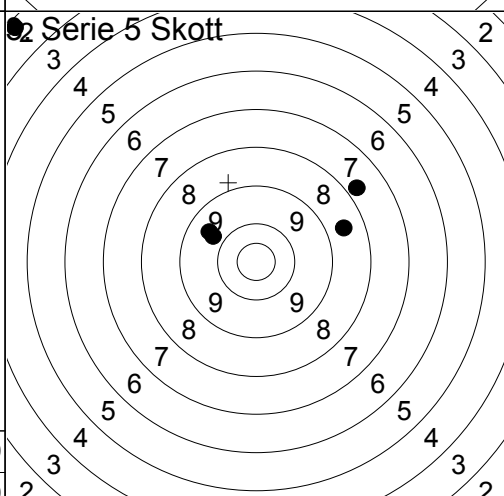

1:	7.8	↗
2:	9.6	↗
3:	9.7	↗
4:	8.6	→
5:	2.2	↗

Serie	35.0
Total	133.0

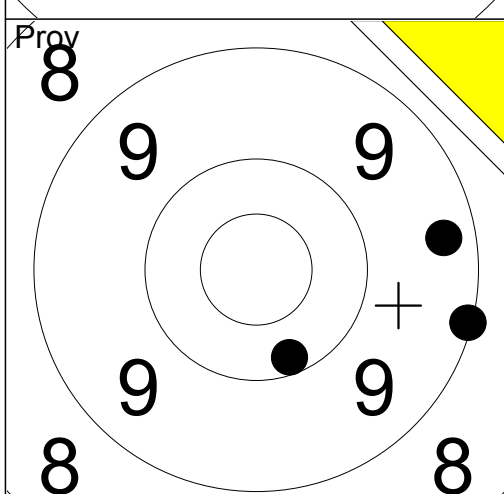

1:	10.2	↓
2:	9.1	→
3:	9.3	→

Serie	28.0
Total	133.0

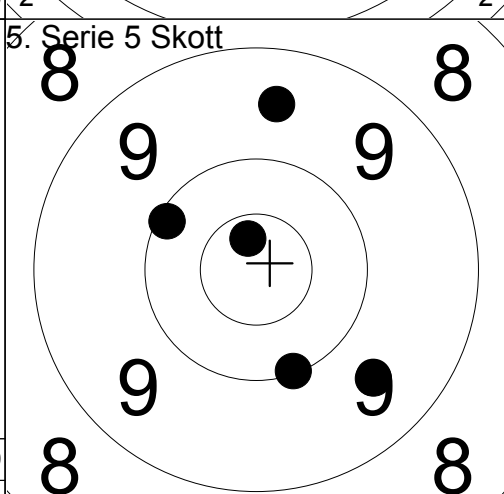

1:	10.7x	↗
2:	10.1	↗
3:	9.6	↙
4:	9.5	↗
5:	10.1	↓

Serie	48.0
Total	181.0

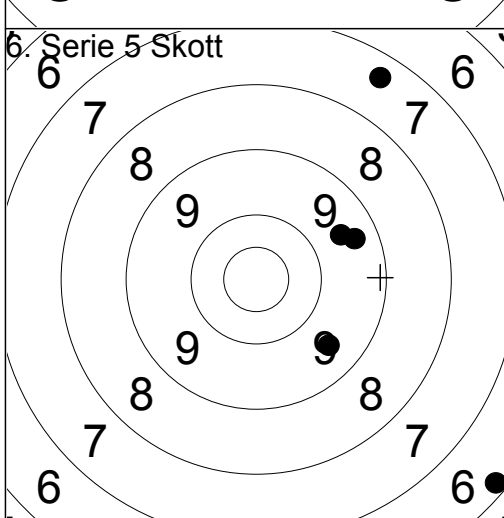

1:	9.5	↙
2:	9.4	→
3:	9.6	↗
4:	6.2	↙
5:	7.4	↗

Serie	40.0
Total	221.0

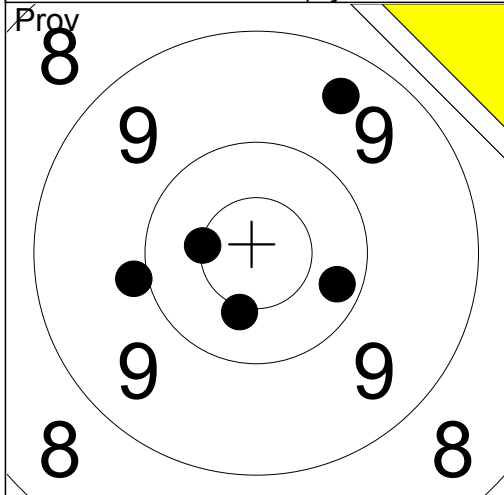

- 1: 9.4 ↗
- 2: 10.5x ←
- 3: 10.4x ↓
- 4: 9.9 ←
- 5: 10.2 ↘

Serie 48.0
Total 0.0

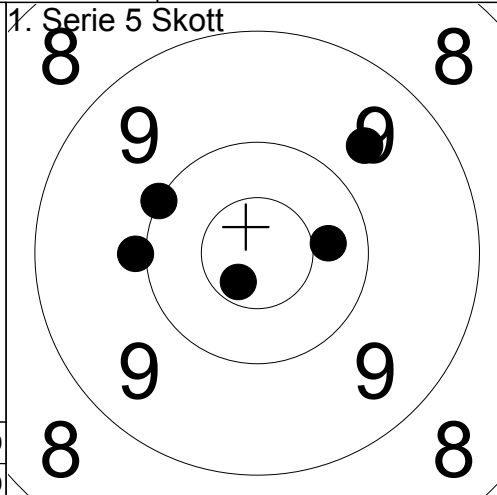

- 1: 9.7 ↗
- 2: 10.4 →
- 3: 9.9 ←
- 4: 10.0 ↖
- 5: 10.7x ↓

Serie 48.0
Total 48.0

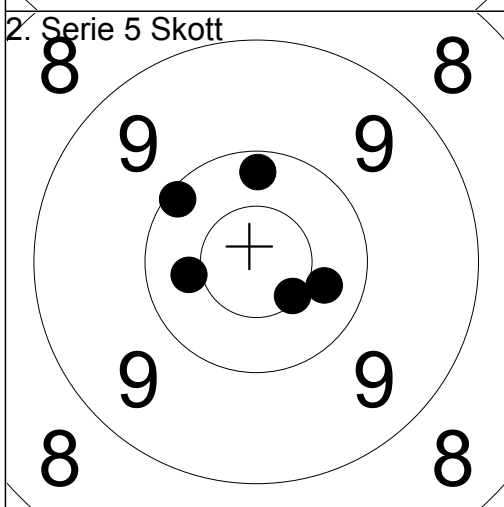

- 1: 10.4 ←
- 2: 10.1 ↗
- 3: 10.4 ↘
- 4: 10.2 ↑
- 5: 10.5x ↓

Serie 50.0
Total 98.0

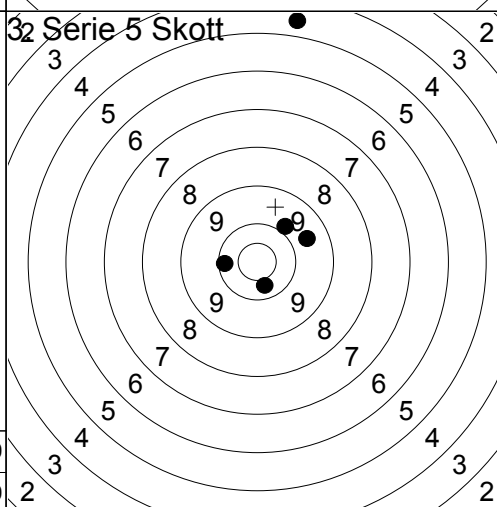

- 1: 9.6 ↗
- 2: 9.8 ↗
- 3: 10.4 ↓
- 4: 4.6 ↑
- 5: 10.2 ←

Serie 42.0
Total 140.0

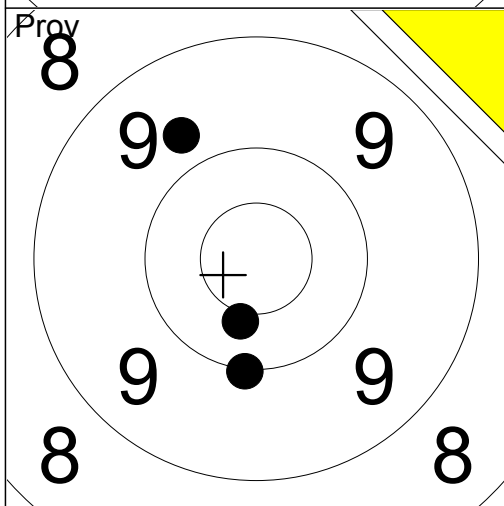

- 1: 10.0 ↓
- 2: 9.7 ↗
- 3: 10.4 ↓

Serie 29.0
Total 140.0

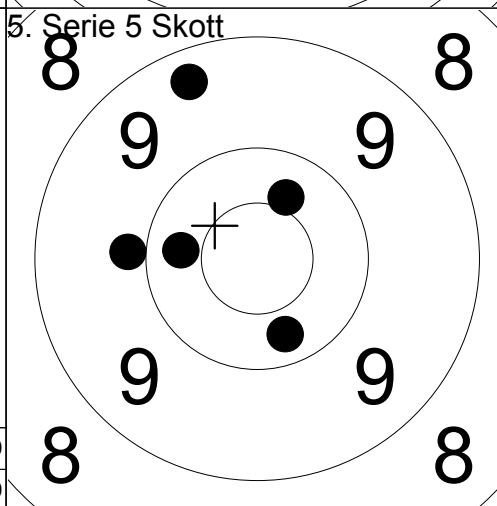

- 1: 9.3 ↗
- 2: 10.3 ←
- 3: 10.4 ↗
- 4: 9.9 ←
- 5: 10.3 ↓

Serie 48.0
Total 188.0

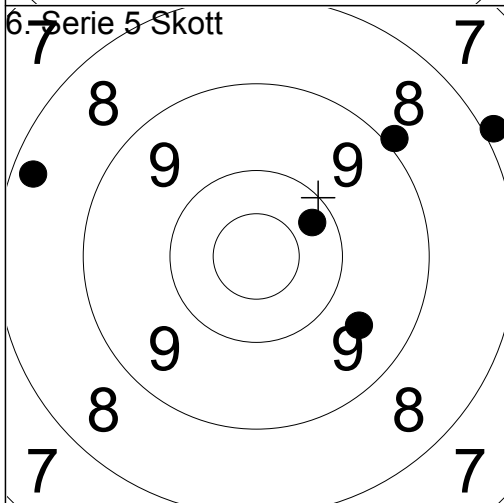

- 1: 10.2 ↗
- 2: 9.6 ↘
- 3: 7.9 ↗
- 4: 8.3 ←
- 5: 8.9 ↗

Serie 42.0
Total 230.0

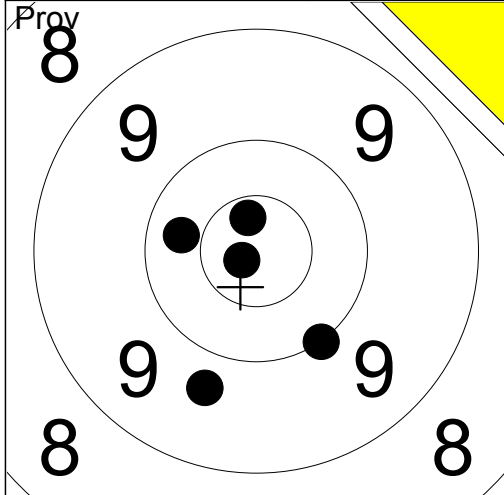

1:	9.7	↘
2:	10.3	←
3:	10.8x	↙
4:	10.7x	↑
5:	10.0	↘

Serie	49.0
Total	0.0

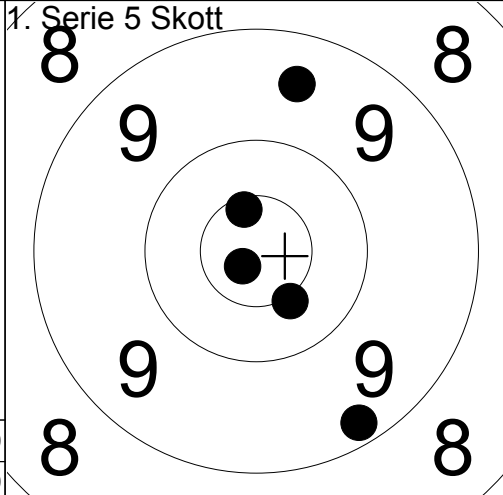

1:	9.5	↑
2:	9.2	↘
3:	10.6x	↑
4:	10.8x	↙
5:	10.4x	↘

Serie	48.0
Total	48.0

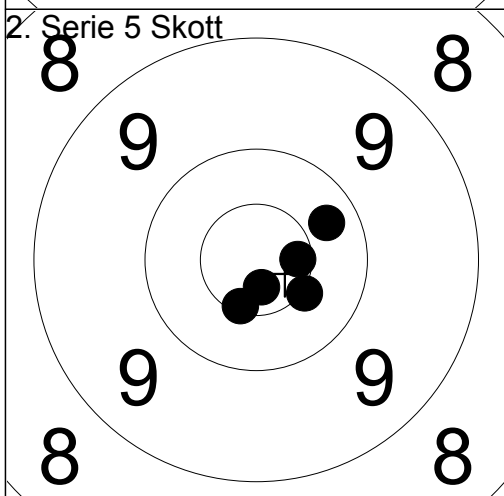

1:	10.5x	↘
2:	10.5x	↘
3:	10.7x	↘
4:	10.6x	→
5:	10.3	↗

Serie	50.0
Total	98.0

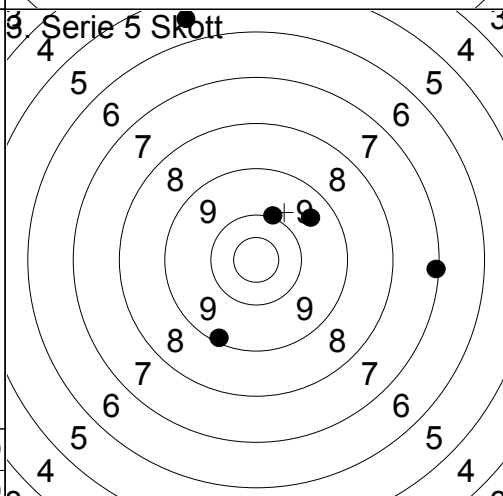

1:	9.5	↗
2:	7.1	→
3:	10.0	↑
4:	5.5	↑
5:	9.1	↘

Serie	40.0
Total	138.0

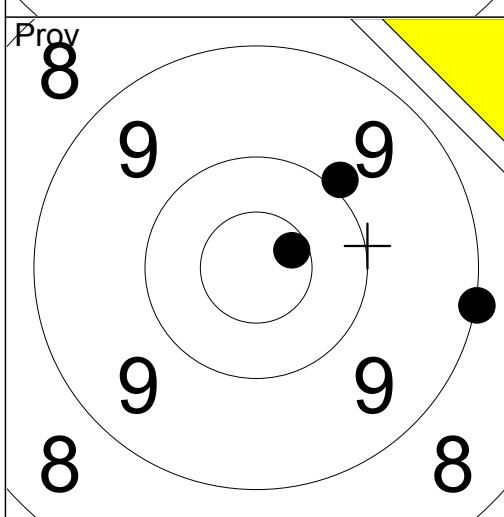

1:	9.9	↗
2:	10.6x	↗
3:	9.0	→

Serie	28.0
Total	138.0

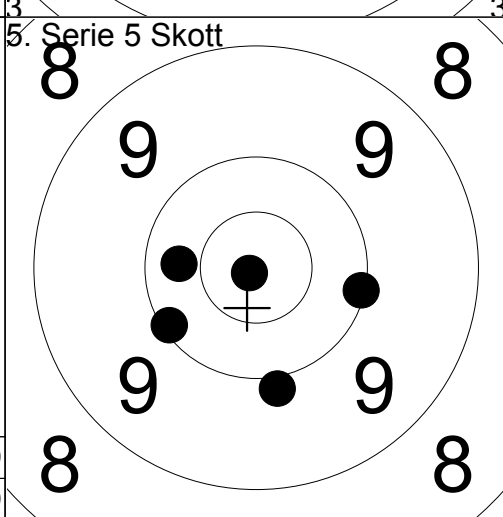

1:	10.9x	↙
2:	10.3	←
3:	10.1	↙
4:	9.9	↘
5:	10.1	→

Serie	49.0
Total	187.0

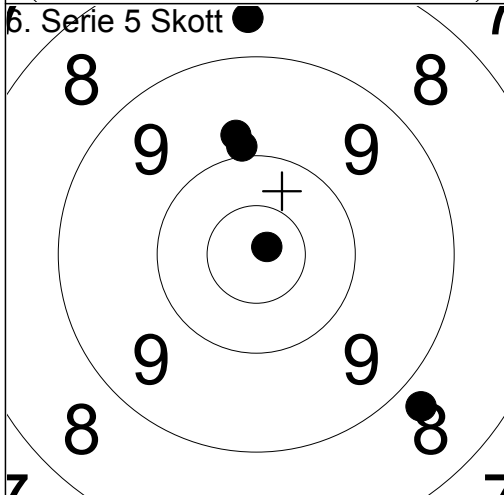

1:	9.9	↑
2:	10.8x	↗
3:	8.8	↘
4:	8.6	↑
5:	9.8	↑

Serie	44.0
Total	231.0

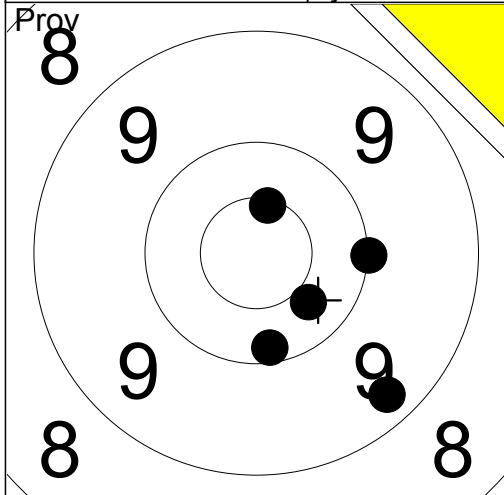

1:	10.2	↘
2:	9.3	↘
3:	10.4	↘
4:	10.5x	↑
5:	10.0	→

Serie	49.0
Total	0.0

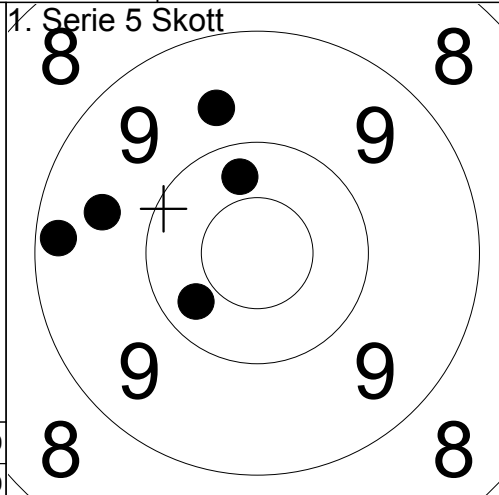

1:	9.2	←
2:	9.7	↑
3:	10.3	↑
4:	9.6	←
5:	10.3	↘

Serie	47.0
Total	47.0

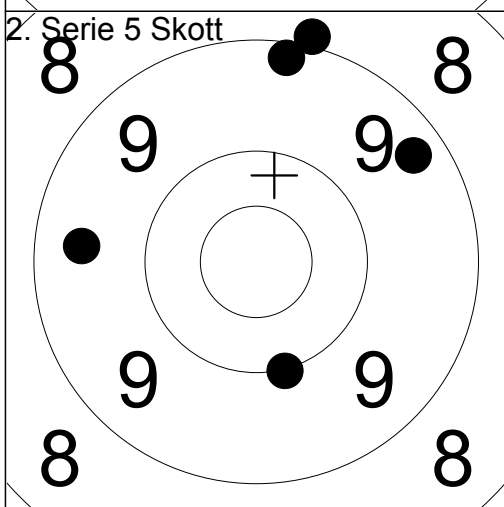

1:	9.3	↗
2:	9.2	↑
3:	8.9	↑
4:	10.0	↘
5:	9.5	←

Serie	45.0
Total	92.0

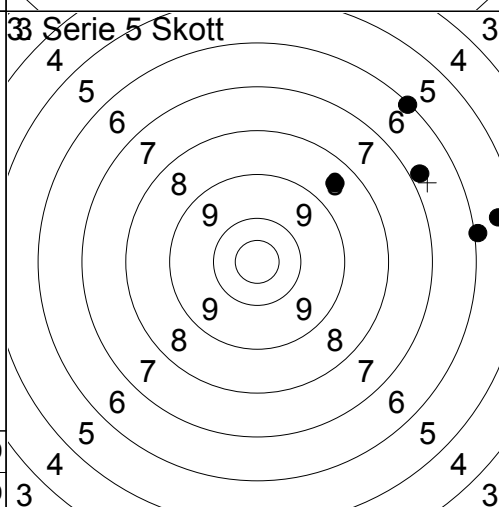

1:	6.8	↗
2:	5.4	→
3:	6.1	↗
4:	8.5	↗
5:	6.0	→

Serie	31.0
Total	123.0

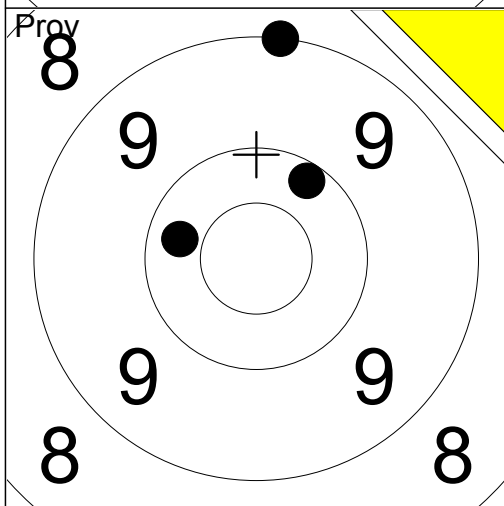

1:	10.3	←
2:	10.2	↗
3:	9.0	↑

Serie	29.0
Total	123.0

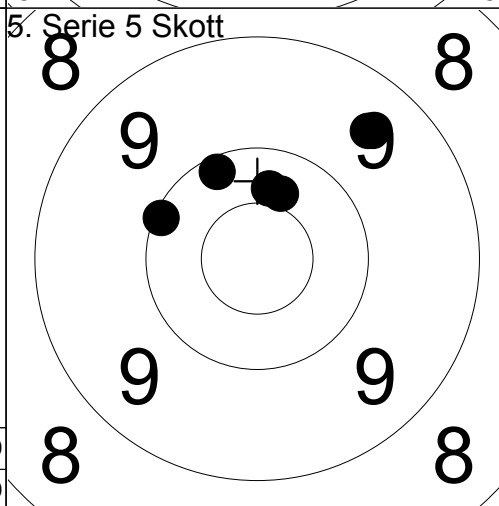

1:	9.5	↗
2:	10.4	↑
3:	10.2	↑
4:	10.4	↑
5:	10.1	↖

Serie	49.0
Total	172.0

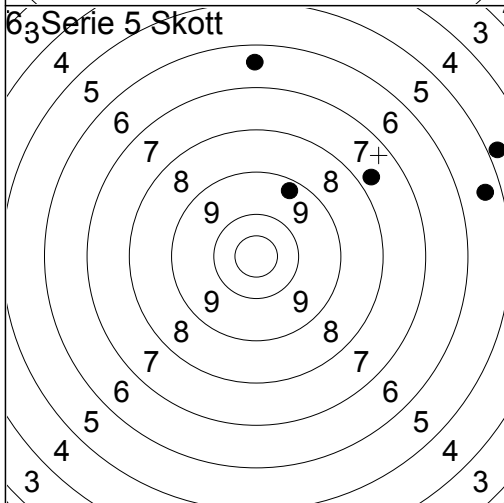

1:	4.8	↗
2:	7.7	↗
3:	9.3	↑
4:	6.4	↑
5:	5.4	→

Serie	31.0
Total	203.0

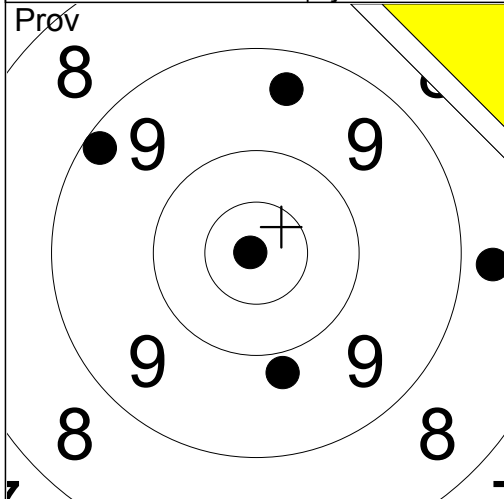

- 1: 9.4 ↗
- 2: 9.2 ↗
- 3: 9.8 ↘
- 4: 8.7 →
- 5: 10.9x ←

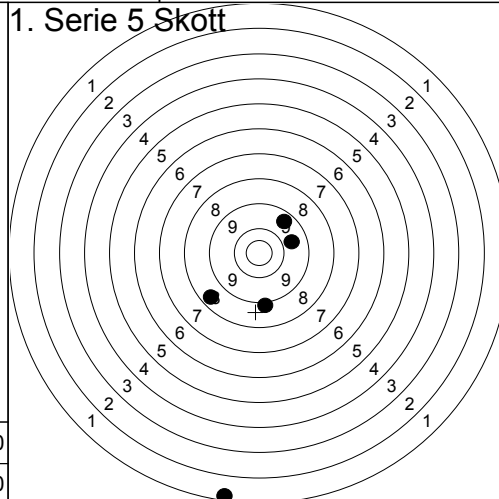

- 1: 9.7 →
- 2: 1.2 ↓
- 3: 8.4 ↙
- 4: 9.4 ↗
- 5: 8.9 ↓

Serie	45.0
Total	0.0

Serie	35.0
Total	35.0

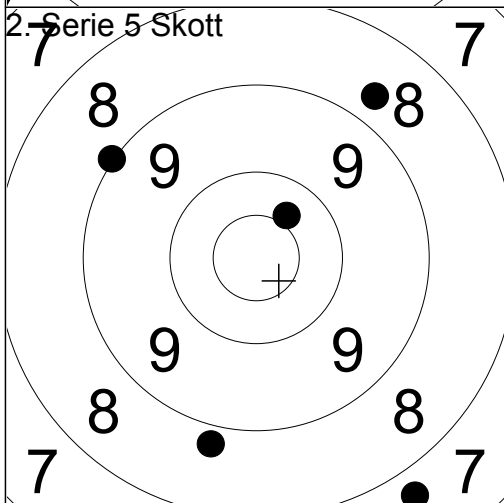

- 1: 8.7 ↗
- 2: 7.7 ↘
- 3: 8.8 ↘
- 4: 10.4 ↗
- 5: 9.0 ↗

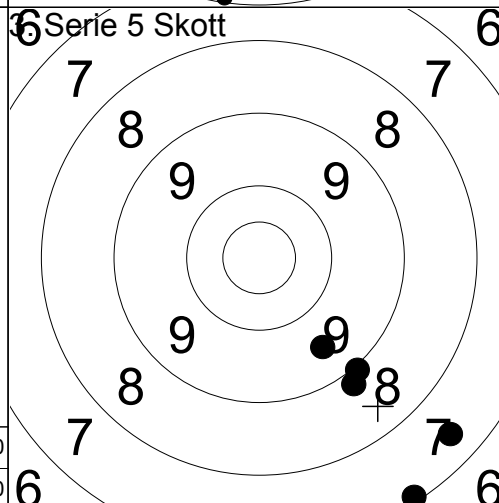

- 1: 8.9 ↘
- 2: 7.4 ↘
- 3: 9.0 ↘
- 4: 9.5 ↘
- 5: 7.1 ↘

Serie	42.0
Total	77.0

Serie	40.0
Total	117.0

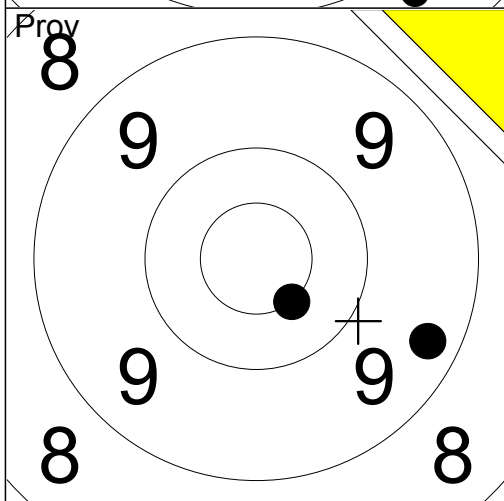

- 1: 9.3 ↘
- 2: 10.5x ↘

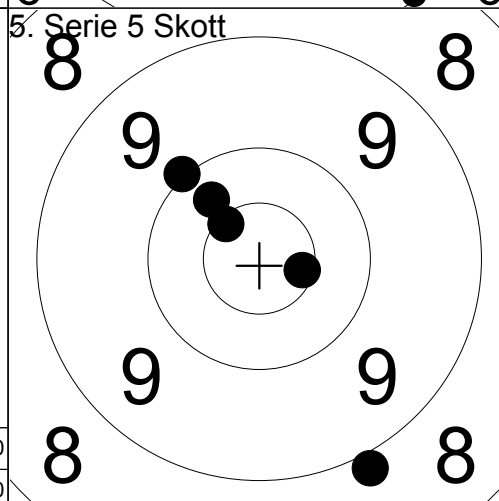

- 1: 10.3 ↗
- 2: 10.5x ↗
- 3: 10.0 ↗
- 4: 8.9 ↘
- 5: 10.6x ↘

Serie	19.0
Total	117.0

Serie	48.0
Total	165.0

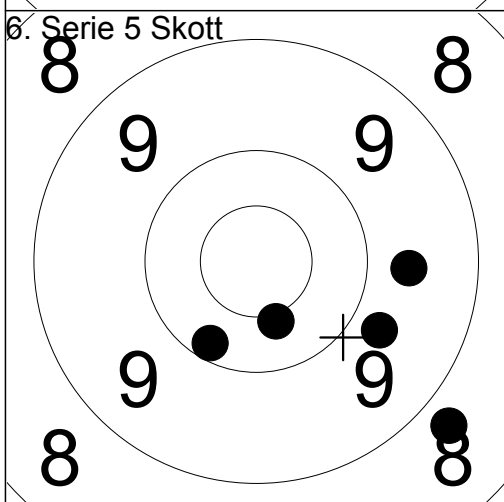

- 1: 10.4x ↘
- 2: 9.7 →
- 3: 10.2 ↘
- 4: 9.8 ↘
- 5: 8.8 ↘

Serie	46.0
Total	211.0

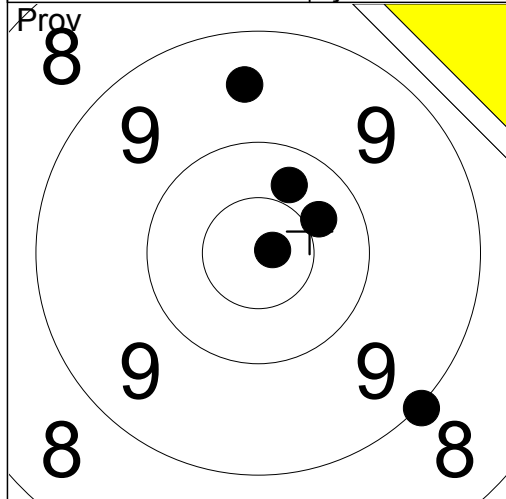

1:	9.5	↑
2:	9.0	↘
3:	10.4	↗
4:	10.8x	→
5:	10.3	↑
Serie	48.0	
Total	0.0	

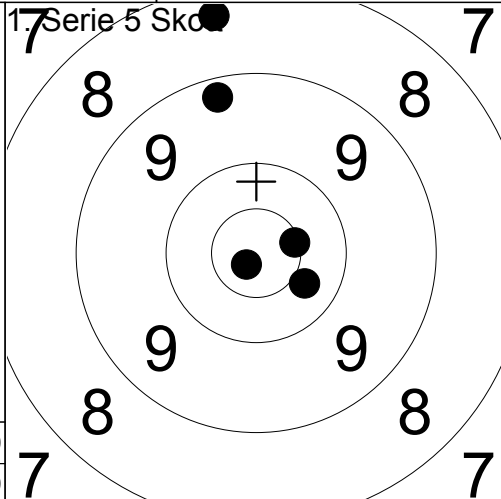

1:	10.5x	→
2:	8.3	↑
3:	9.2	↑
4:	10.4	↘
5:	10.8x	↘
Serie	47.0	
Total	47.0	

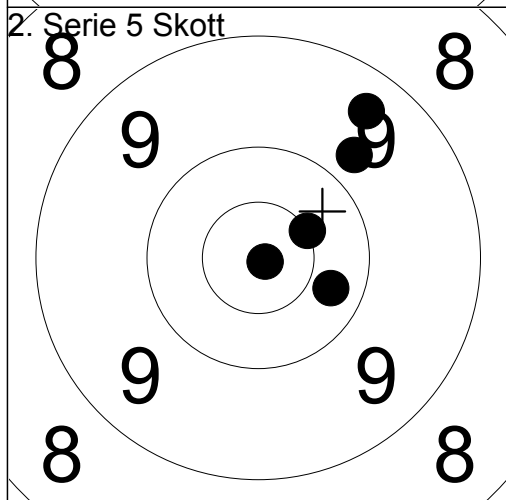

1:	9.4	↗
2:	9.8	↗
3:	10.5x	↗
4:	10.9x	↘
5:	10.3	↘
Serie	48.0	
Total	95.0	

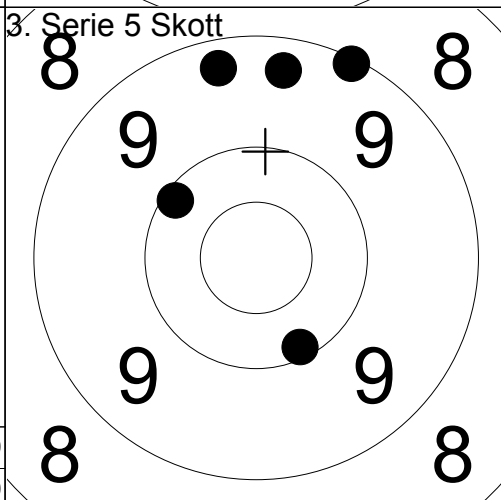

1:	10.1	↖
2:	9.3	↑
3:	10.1	↘
4:	9.1	↗
5:	9.3	↑
Serie	47.0	
Total	142.0	

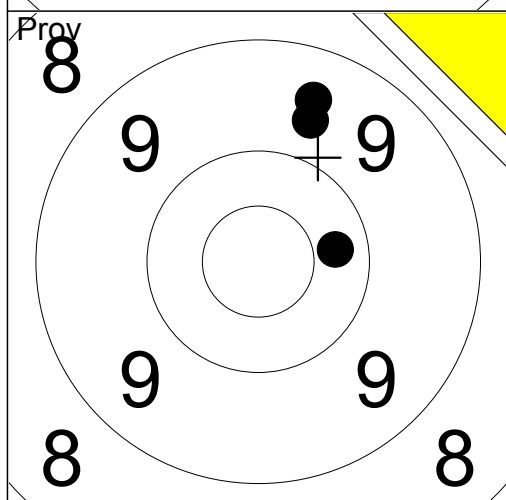

1:	9.5	↑
2:	10.3	→
3:	9.7	↑
Serie	28.0	
Total	142.0	

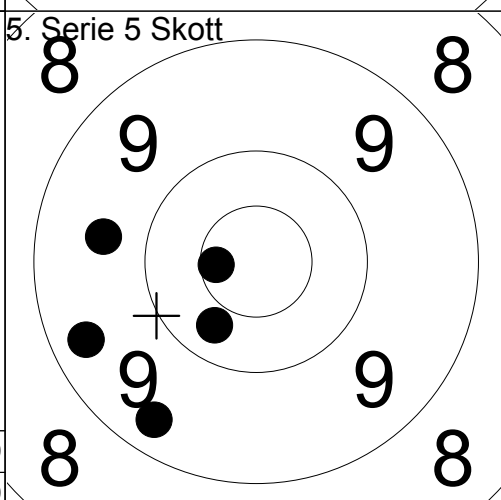

1:	9.3	↖
2:	10.6x	←
3:	10.3	↘
4:	9.3	↘
5:	9.6	←
Serie	47.0	
Total	189.0	

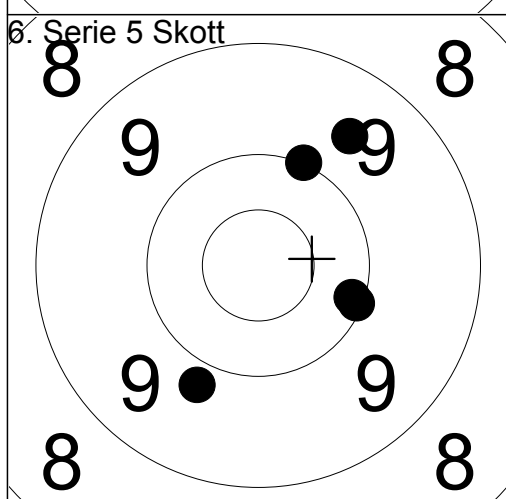

1:	9.6	↗
2:	10.1	↘
3:	10.1	↘
4:	10.0	↑
5:	9.8	↘
Serie	48.0	
Total	237.0	

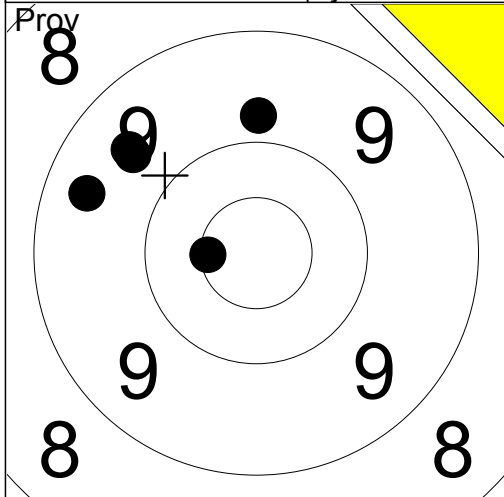

1:	9.6	↗
2:	9.6	↗
3:	10.5x	←
4:	9.4	↖
5:	9.8	↑

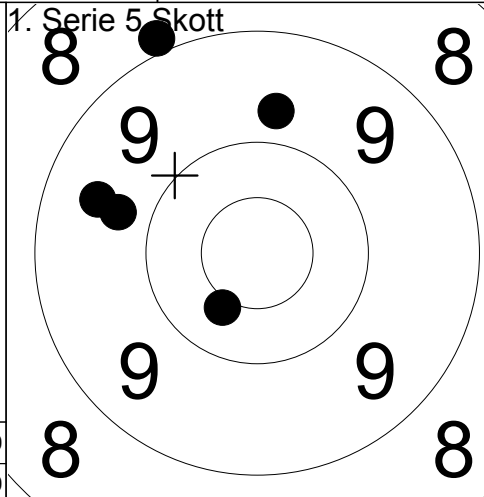

1:	8.9	↗
2:	9.7	↖
3:	9.5	↖
4:	9.7	↑
5:	10.4	↘

Serie	46.0
Total	0.0

Serie	45.0
Total	45.0

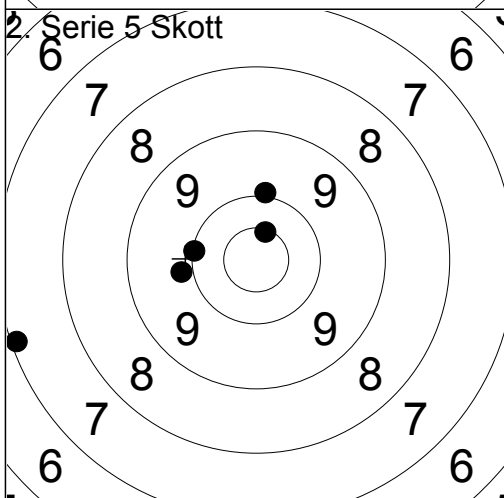

1:	10.0	↑
2:	10.1	←
3:	9.9	←
4:	7.1	←
5:	10.5x	↑

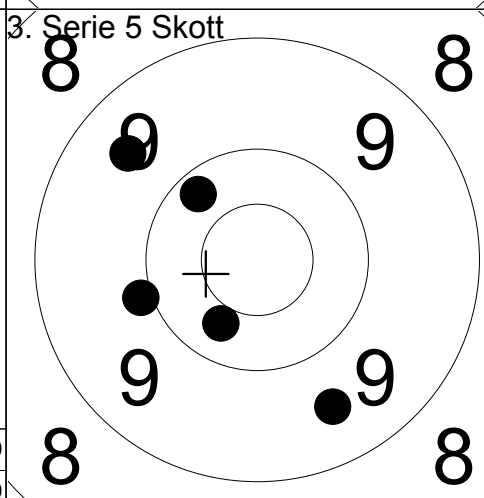

1:	10.2	↗
2:	9.5	↘
3:	9.9	←
4:	9.5	↗
5:	10.3	↘

Serie	46.0
Total	91.0

Serie	47.0
Total	138.0

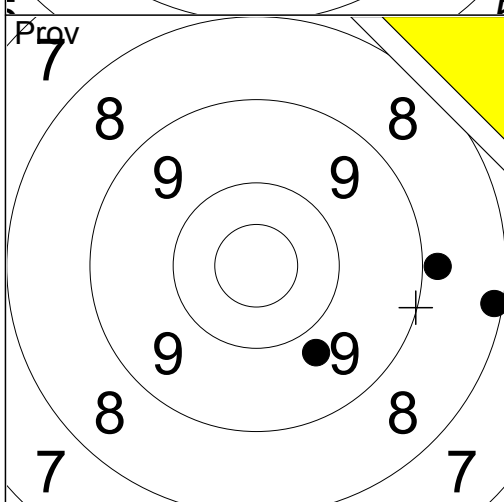

1:	8.8	→
2:	9.8	↘
3:	8.1	→

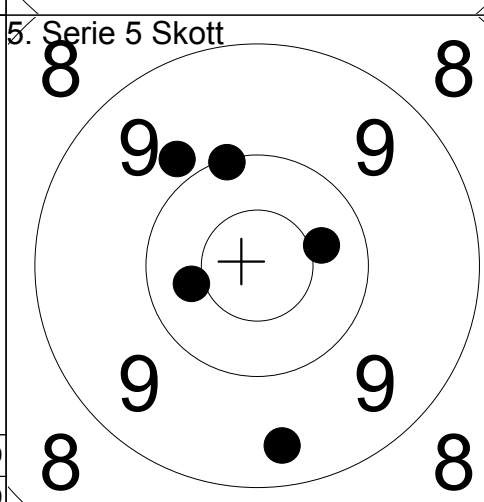

1:	9.8	↗
2:	10.1	↑
3:	10.4	←
4:	10.4	→
5:	9.4	↘

Serie	25.0
Total	138.0

Serie	48.0
Total	186.0

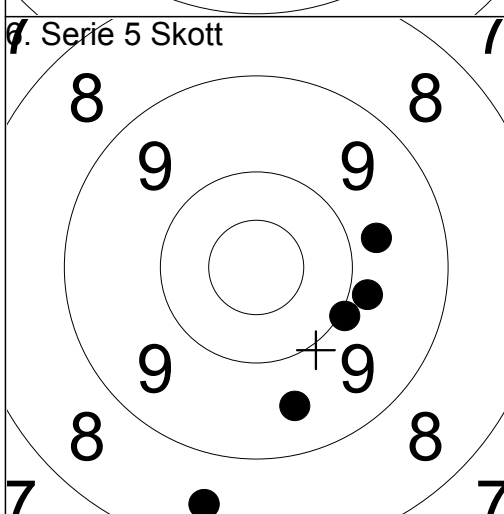

1:	9.7	→
2:	9.5	↘
3:	10.0	↘
4:	9.8	→
5:	8.5	↘

Serie	45.0
Total	231.0

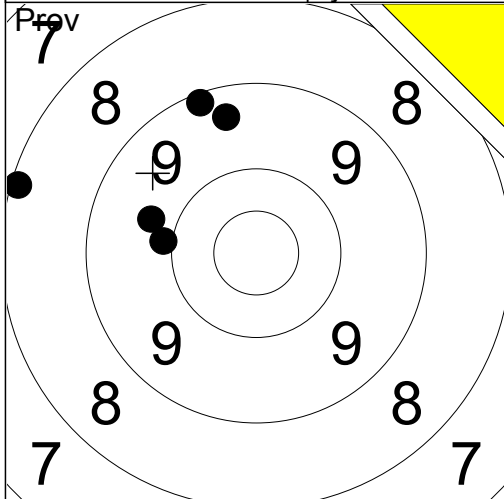

- 1: 9.1 ↗
- 2: 8.1 ↖
- 3: 9.9 ←
- 4: 9.7 ↖
- 5: 9.4 ↗

Serie	44.0
Total	0.0

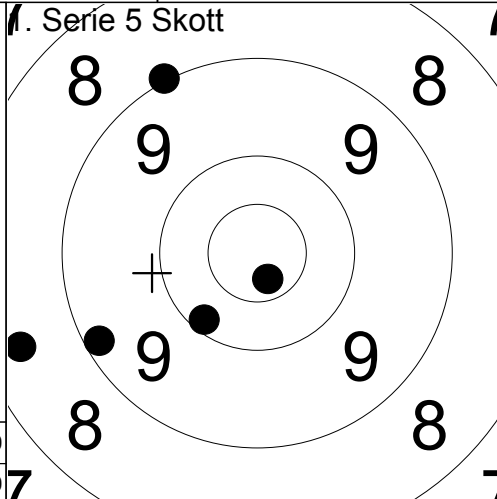

- 1: 10.1 ↘
- 2: 10.7x ↘
- 3: 9.0 ↗
- 4: 8.4 ↖
- 5: 9.2 ↘

Serie	46.0
Total	46.0

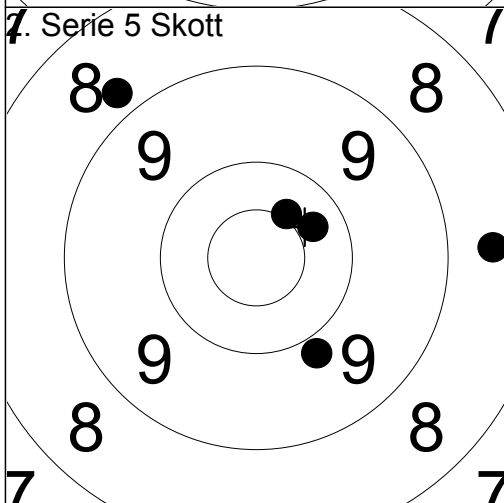

- 1: 8.8 ↖
- 2: 8.6 →
- 3: 10.3 ↗
- 4: 10.4x ↗
- 5: 9.9 ↘

Serie	45.0
Total	91.0

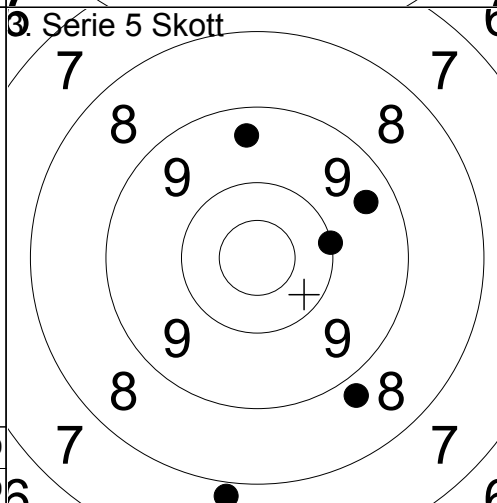

- 1: 9.4 ↗
- 2: 9.4 →
- 3: 10.0 →
- 4: 8.8 ↘
- 5: 7.9 ↘

Serie	43.0
Total	134.0

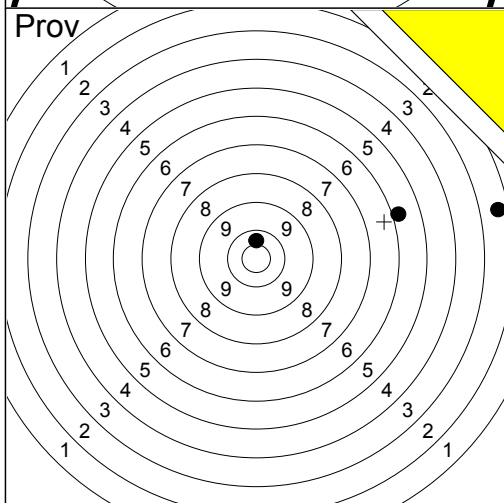

- 1: 5.8 →
- 2: 2.4 →
- 3: 10.4 ↗

Serie	17.0
Total	134.0

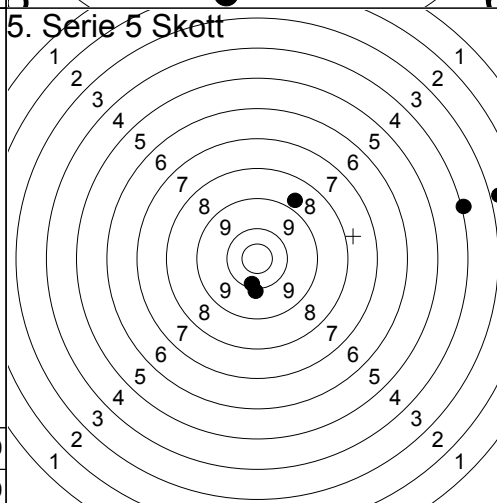

- 1: 2.7 →
- 2: 4.0 →
- 3: 8.7 ↗
- 4: 9.9 ↘
- 5: 10.2 ↘

Serie	33.0
Total	167.0

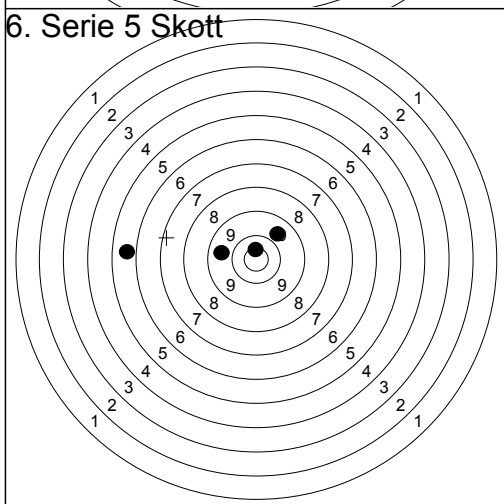

- 1: 0.0 ←
- 2: 9.7 ↗
- 3: 10.6x ↗
- 4: 5.7 ←
- 5: 9.6 ←

Serie	33.0
Total	200.0

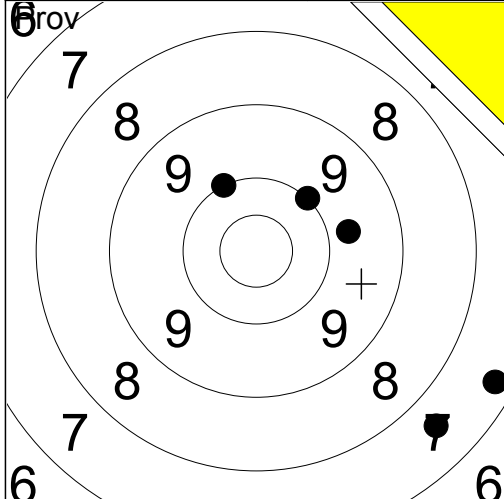

1:	7.3	↘
2:	10.0	↗
3:	9.7	→
4:	10.0	↗
5:	7.6	↘

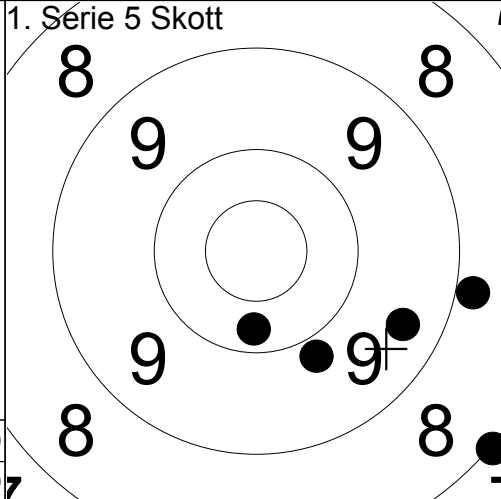

1:	9.4	↘
2:	8.9	→
3:	8.0	↘
4:	9.8	↘
5:	10.2	↘

Serie	43.0
Total	0.0

Serie	44.0
Total	44.0

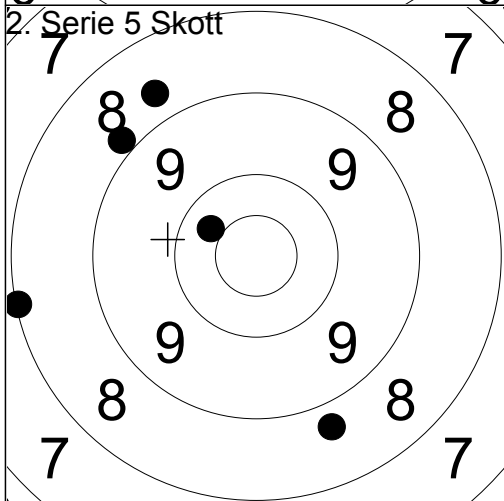

1:	8.1	←
2:	8.7	↘
3:	10.3	↗
4:	8.9	↗
5:	8.7	↗

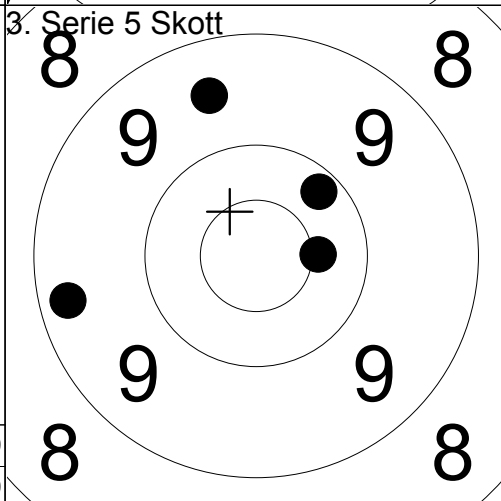

1:	9.5	↗
2:	10.2	↗
3:	10.4x	→
4:	9.3	←
5:	0.0	

Serie	42.0
Total	86.0

Serie	38.0
Total	124.0

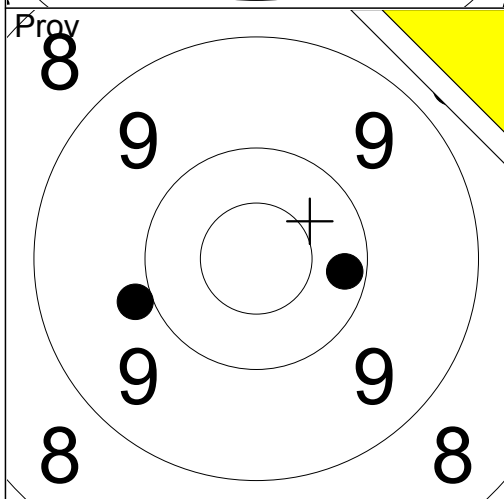

1:	9.9	←
2:	8.7	↗
3:	10.2	→

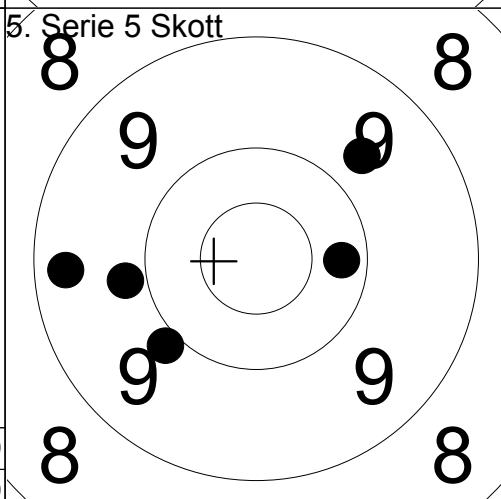

1:	9.3	←
2:	9.8	←
3:	9.9	↘
4:	10.2	→
5:	9.7	↗

Serie	27.0
Total	124.0

Serie	46.0
Total	170.0

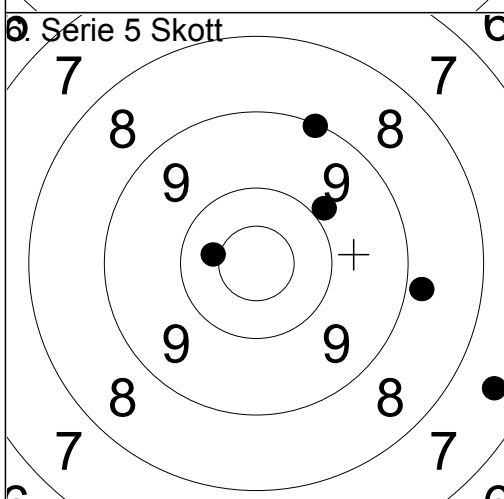

1:	9.1	↗
2:	9.9	↗
3:	8.8	→
4:	10.4	←
5:	7.5	↘

Serie	43.0
Total	213.0

Skjutlag
3

Tavla
16

Saga Ebbhagen

300m

Ramselefors

Ligg

Vb

09.07.2016

Björskottet 2016

Ramselefors SKF

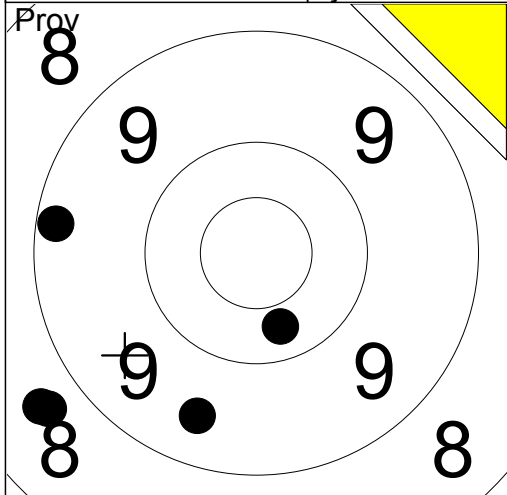

1:	9.5	↘
2:	8.7	↙
3:	8.7	↙
4:	10.3	↘
5:	9.2	↙
Serie		44.0
Total		0.0

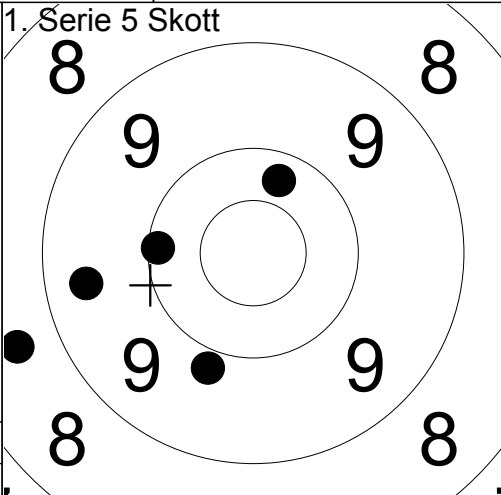

1:	9.9	↘
2:	9.4	↙
3:	8.6	↙
4:	10.3	↗
5:	10.1	↙
Serie		46.0
Total		46.0

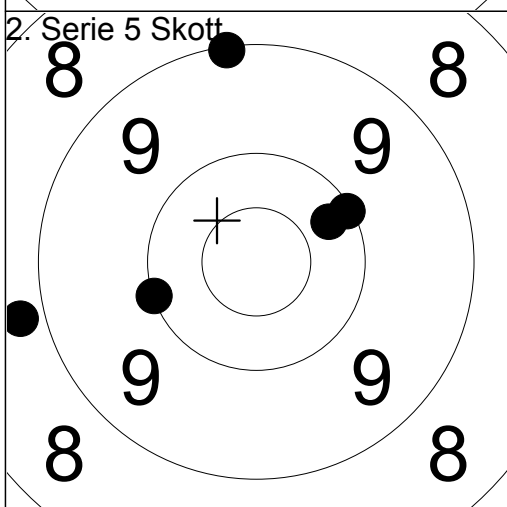

1:	10.2	↗
2:	10.1	↗
3:	9.1	↗
4:	8.8	↙
5:	10.0	↙
Serie		47.0
Total		93.0

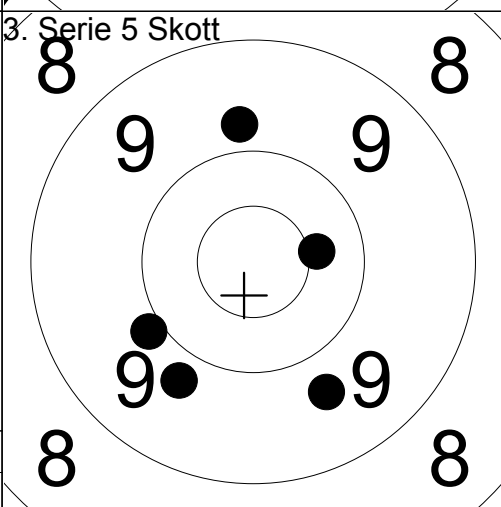

1:	10.4	↗
2:	9.8	↘
3:	9.7	↘
4:	9.9	↙
5:	9.8	↗
Serie		46.0
Total		139.0

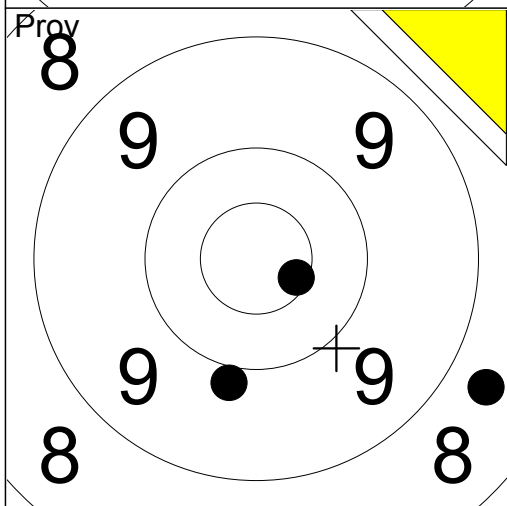

1:	8.7	↘
2:	10.6x	↘
3:	9.9	↘
Serie		27.0
Total		139.0

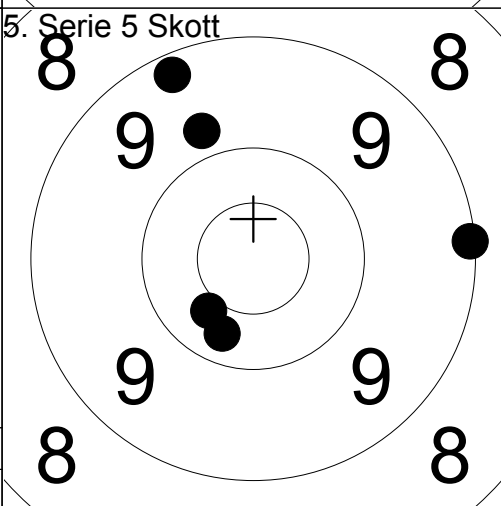

1:	9.1	↗
2:	10.3	↘
3:	10.4	↙
4:	9.8	↗
5:	9.2	↗
Serie		47.0
Total		186.0

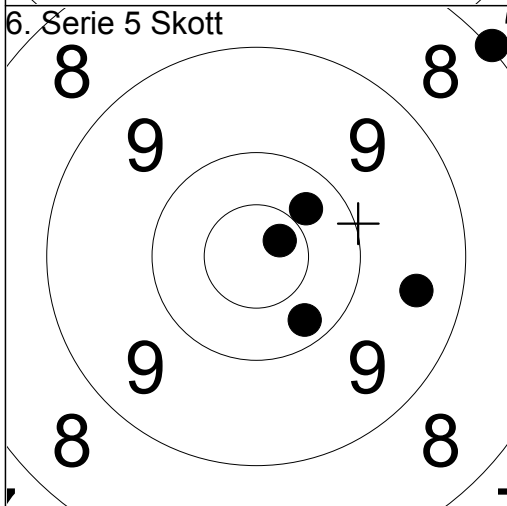

1:	10.7x	↗
2:	10.3	↗
3:	10.2	↘
4:	8.0	↗
5:	9.5	↗
Serie		47.0
Total		233.0

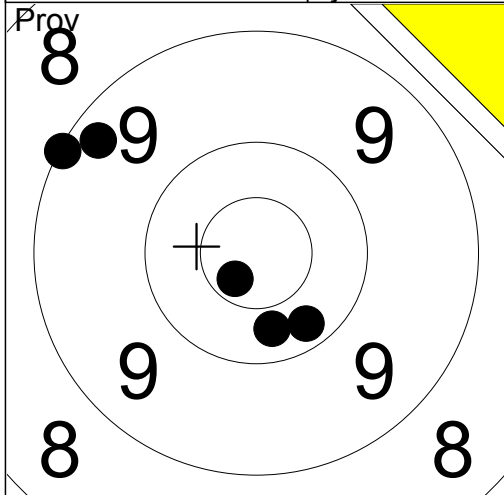

- 1: 9.1 ↗
- 2: 9.3 ↗
- 3: 10.7x ↘
- 4: 10.2 ↘
- 5: 10.3 ↘

Serie	48.0
Total	0.0

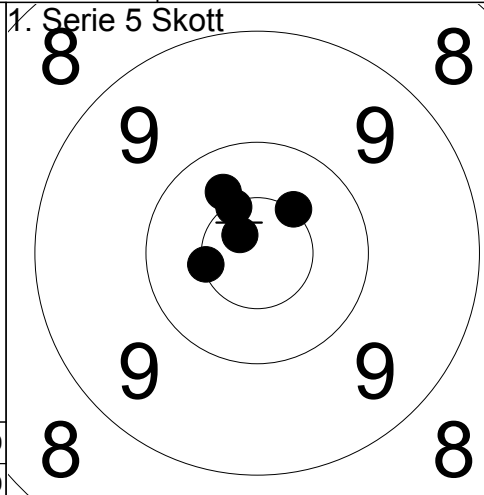

- 1: 10.5x ↗
- 2: 10.4 ↗
- 3: 10.5x ←
- 4: 10.7x ↗
- 5: 10.5x ↗

Serie	50.0
Total	50.0

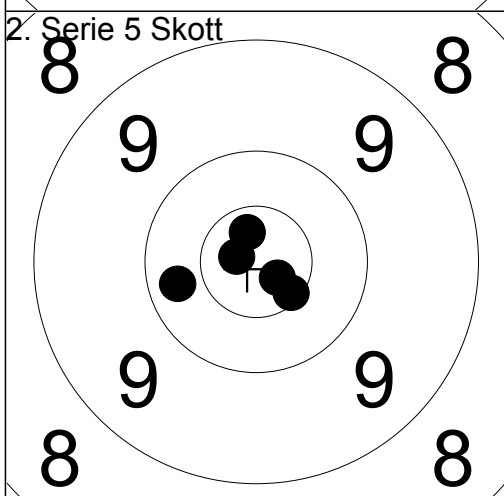

- 1: 10.6x ↘
- 2: 10.7x ↗
- 3: 10.7x ↘
- 4: 10.3 ←
- 5: 10.8x ↗

Serie	50.0
Total	100.0

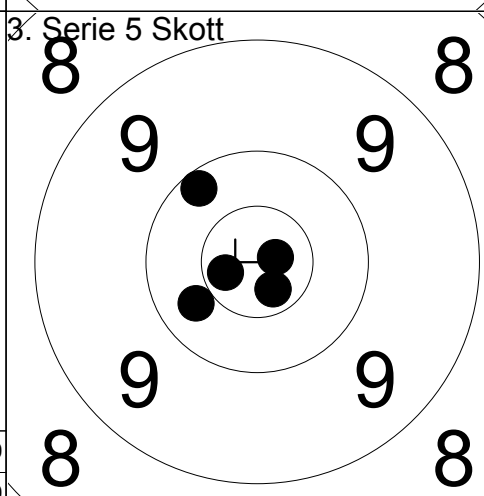

- 1: 10.7x ↘
- 2: 10.2 ↗
- 3: 10.8x →
- 4: 10.7x ←
- 5: 10.3 ↘

Serie	50.0
Total	150.0

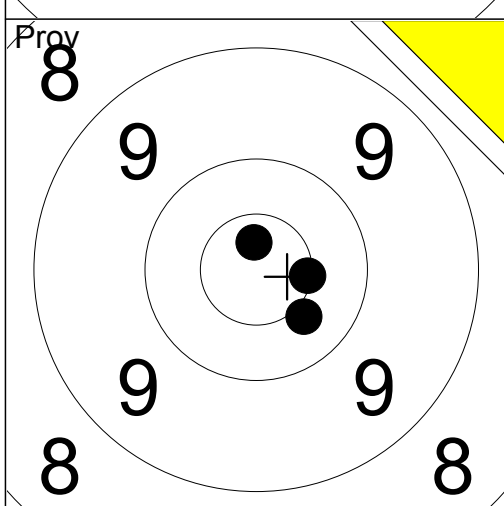

- 1: 10.4 ↘
- 2: 10.7x ↗
- 3: 10.5x →

Serie	30.0
Total	150.0

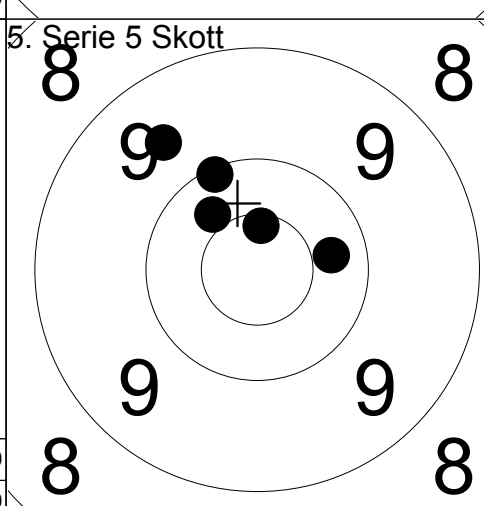

- 1: 10.6x ↗
- 2: 10.3 →
- 3: 9.6 ↗
- 4: 10.1 ↗
- 5: 10.4 ↗

Serie	49.0
Total	199.0

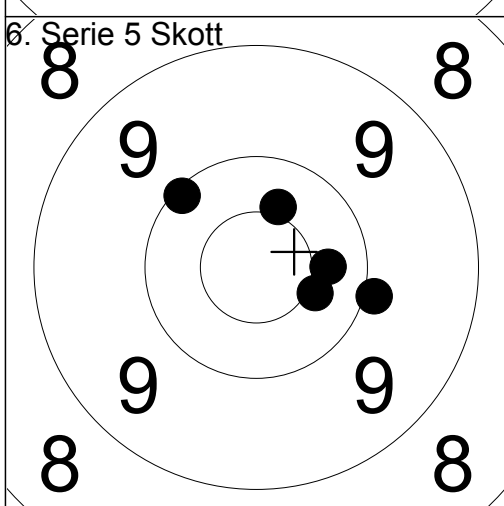

- 1: 9.9 →
- 2: 10.4 →
- 3: 10.4x ↗
- 4: 10.4x ↘
- 5: 10.1 ↗

Serie	49.0
Total	248.0

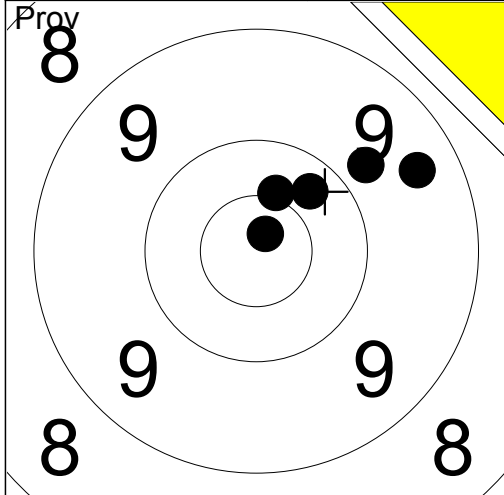

1:	10.8x	↗
2:	9.8	↗
3:	9.4	↗
4:	10.3	↗
5:	10.4x	↗
Serie		48.0
Total		0.0

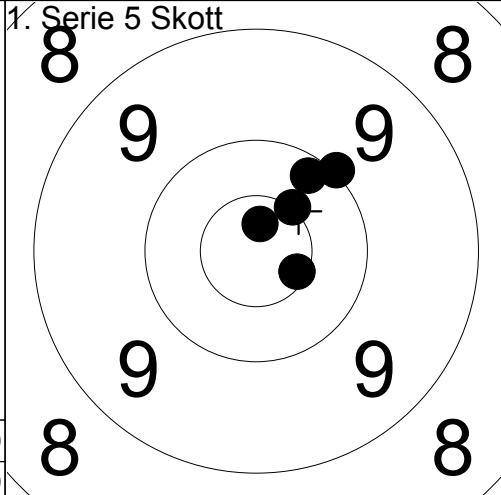

1:	10.2	↗
2:	10.0	↗
3:	10.7x	↑
4:	10.6x	↘
5:	10.5x	↗
Serie		50.0
Total		50.0

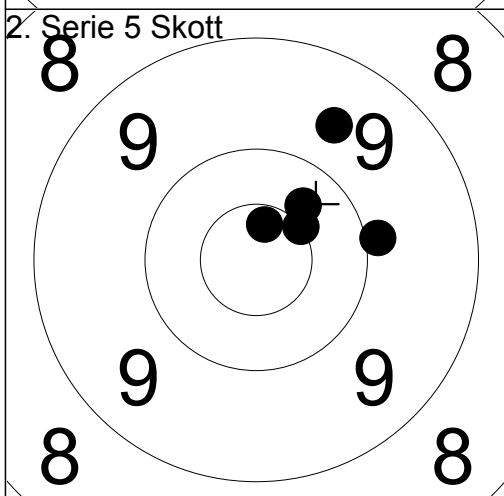

1:	9.9	→
2:	10.3	↗
3:	9.6	↗
4:	10.5x	↗
5:	10.6x	↑
Serie		48.0
Total		98.0

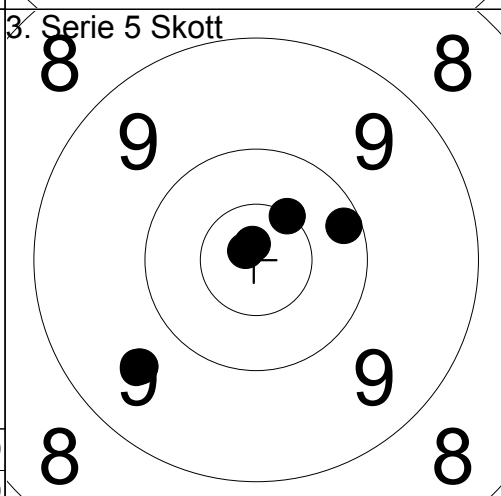

1:	9.6	↙
2:	10.8x	↑
3:	10.2	↗
4:	10.5x	↗
5:	10.8x	↙
Serie		49.0
Total		147.0

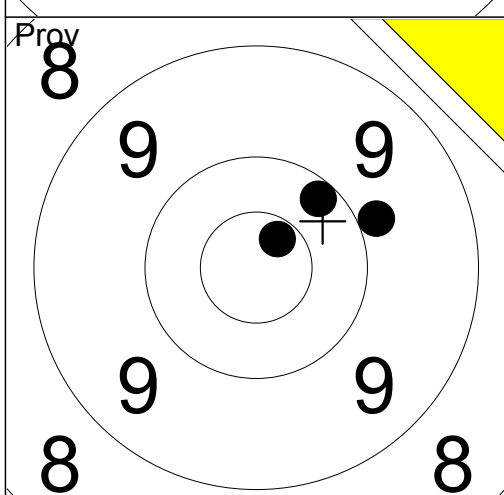

1:	10.7x	↗
2:	10.2	↗
3:	9.9	→
Serie		29.0
Total		147.0

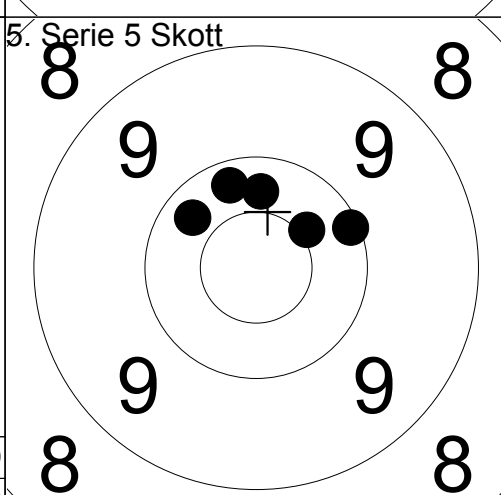

1:	10.1	↗
2:	10.3	↑
3:	10.4x	↗
4:	10.2	↑
5:	10.3	↗
Serie		50.0
Total		197.0

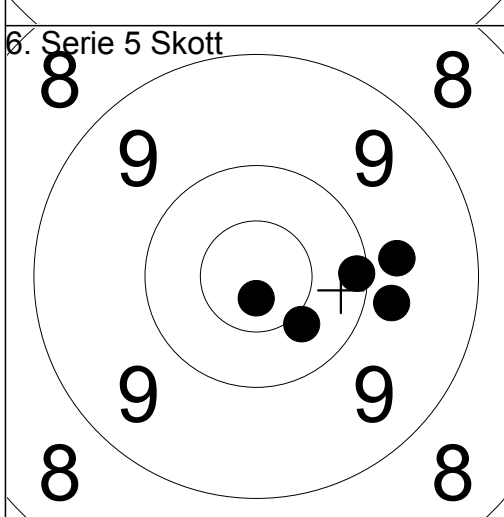

1:	10.1	→
2:	9.8	→
3:	9.8	→
4:	10.8x	↓
5:	10.4	↘
Serie		48.0
Total		245.0

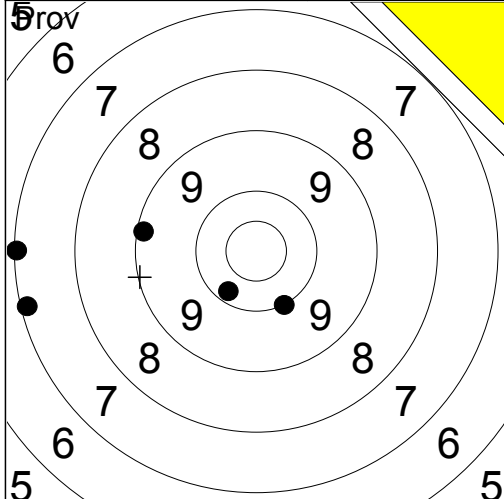

1. Serie 5 Skott

1:	7.1	←
2:	7.1	←
3:	9.1	←
4:	10.2	↘
5:	10.0	↘
Serie	43.0	
Total	0.0	

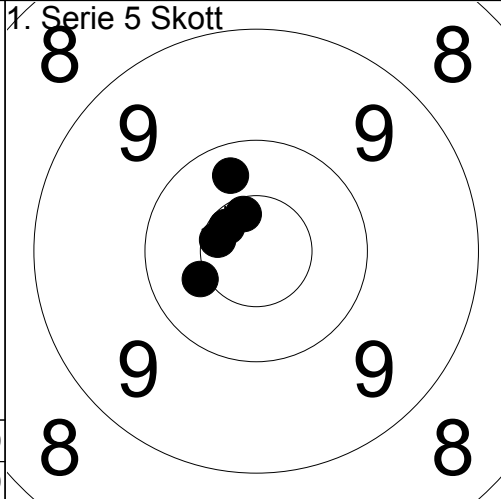

1:	10.3	↗
2:	10.6x	↗
3:	10.6x	↗
4:	10.6x	←
5:	10.4x	↖
Serie	50.0	
Total	50.0	

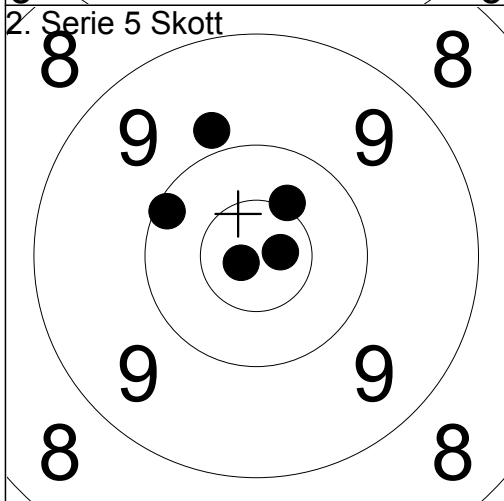

1:	10.1	↖
2:	9.8	↗
3:	10.4x	↗
4:	10.7x	→
5:	10.8x	←
Serie	49.0	
Total	99.0	

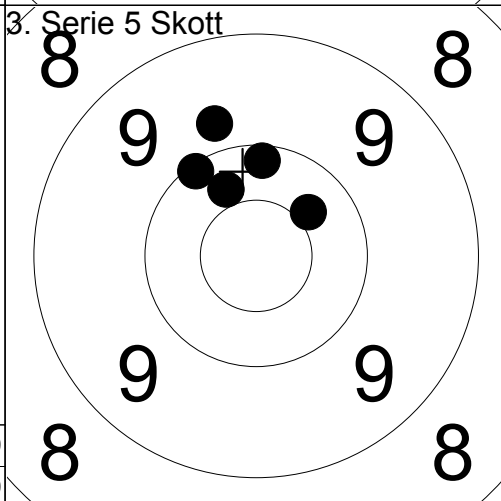

1:	10.1	↖
2:	9.8	↗
3:	10.3	↗
4:	10.2	↗
5:	10.4	↗
Serie	49.0	
Total	148.0	

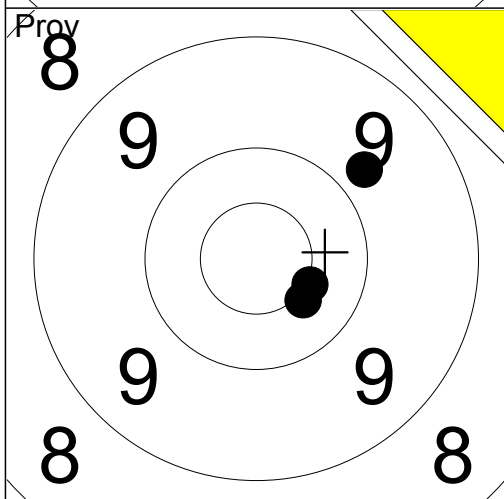

1:	10.5x	↘
2:	10.4x	↘
3:	9.8	↗
Serie	29.0	
Total	148.0	

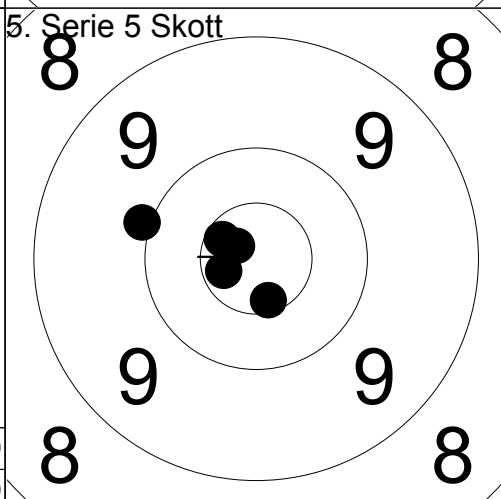

1:	10.8x	↖
2:	10.0	←
3:	10.7x	←
4:	10.6x	↖
5:	10.6x	↘
Serie	50.0	
Total	198.0	

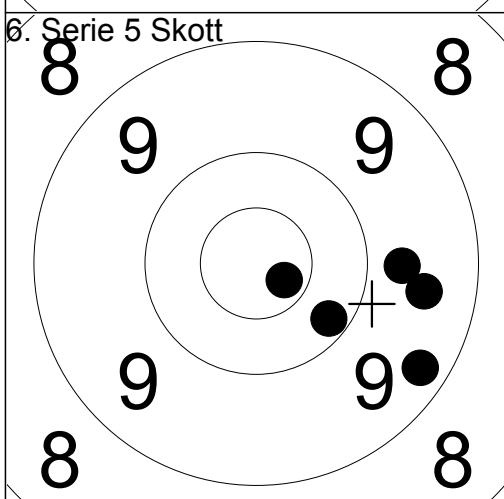

1:	10.2	↘
2:	10.7x	↘
3:	9.3	↘
4:	9.5	→
5:	9.7	→
Serie	47.0	
Total	245.0	