

1:	9.7	↘
2:	9.1	↘
3:	8.9	↘
4:	10.2	←
5:	10.3x	↘
6:	9.0	↙
7:	9.4	↗
8:	9.8	↘
9:	10.1	↘
10:	10.1	↗

Serie	93.0
Total	194.0

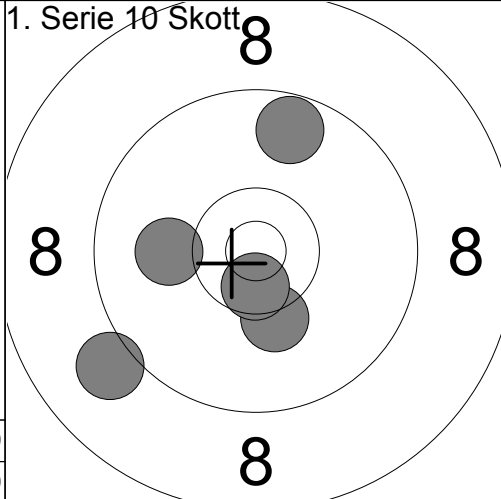

1:	10.2	↘
2:	9.1	↙
3:	10.6x	↘
4:	9.7	↗
5:	10.1	←

Serie	48.0
Total	242.0

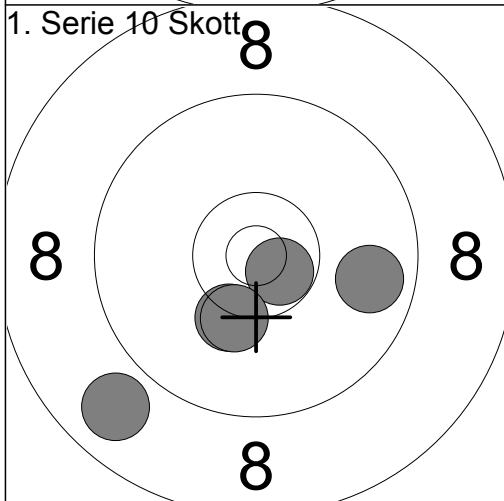

6:	10.3	↘
7:	8.8	↘
8:	9.8	↗
9:	10.7x	↘
10:	10.3	↘

Serie	47.0
Total	289.0

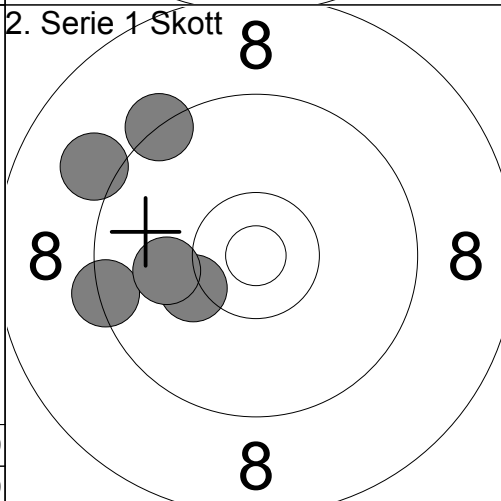

1:	9.4	←
2:	10.2	←
3:	9.3	↗
4:	9.1	↗
5:	10.0	←

Serie	47.0
Total	336.0

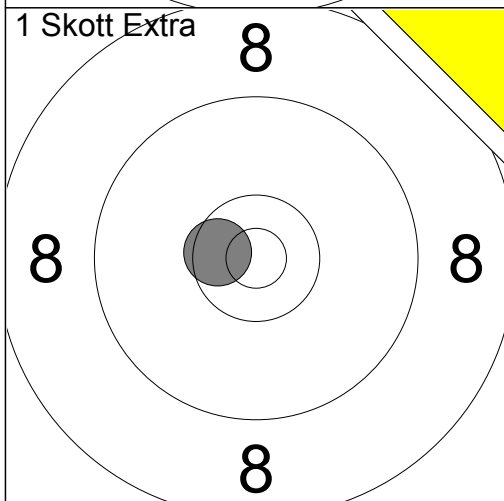

1:	10.5x	←
----	-------	---

Serie	10.0
Total	336.0

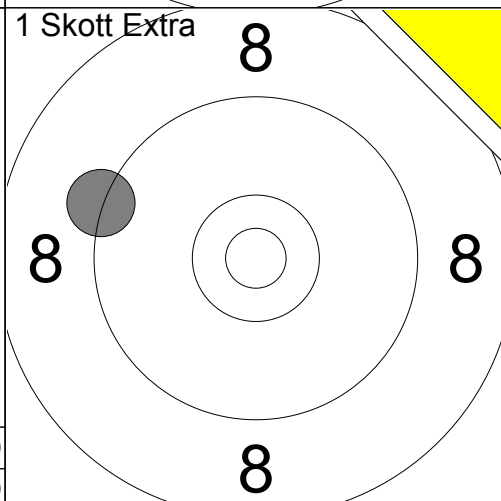

1:	9.3	←
----	-----	---

Serie	9.0
Total	336.0

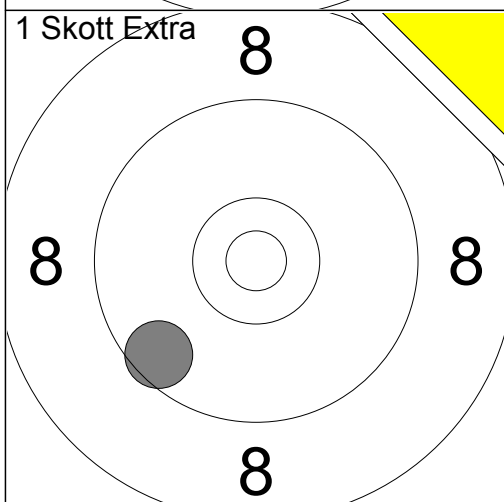

1:	9.6	↙
----	-----	---

Serie	9.0
Total	336.0

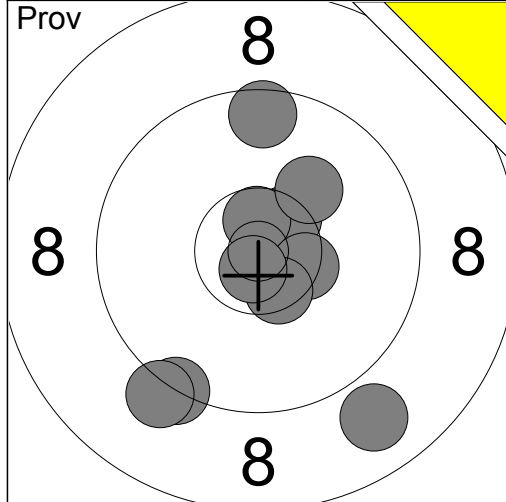

1:	10.5x	↗
2:	9.3	↘
3:	9.2	↘
4:	10.6x	↗
5:	8.9	↘
6:	10.4x	→
7:	10.1	↗
8:	10.5x	↘
9:	9.6	↗
10:	10.8x	↘

Serie	95.0
Total	193.0

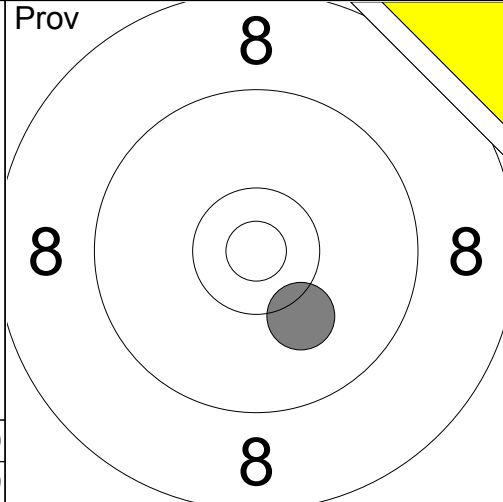

11:	10.1	↘
-----	------	---

Serie	10.0
Total	193.0

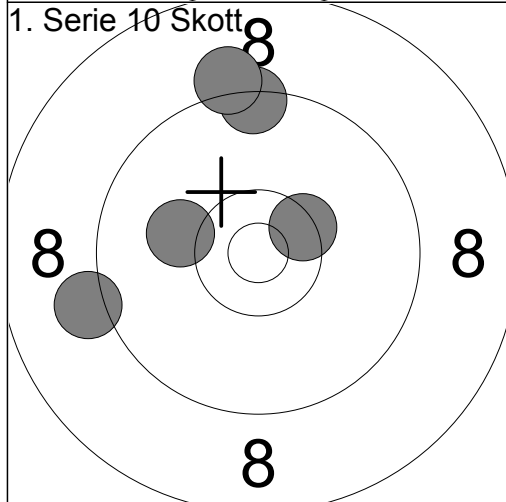

1:	9.4	↑
2:	9.2	↑
3:	10.1	←
4:	10.4x	↗
5:	9.1	←

Serie	47.0
Total	240.0

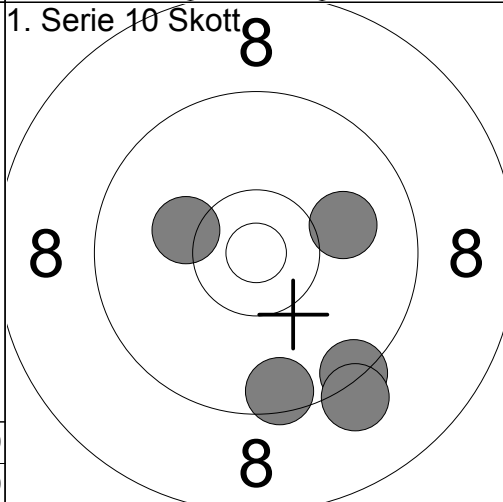

6:	9.5	↘
7:	9.4	↘
8:	9.2	↘
9:	10.0	→
10:	10.2	←

Serie	47.0
Total	287.0

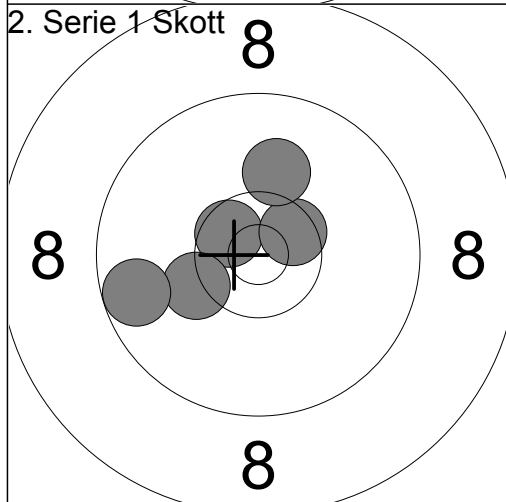

1:	10.6x	↖
2:	10.2	←
3:	9.6	←
4:	10.5x	↗
5:	10.1	↑

Serie	49.0
Total	336.0

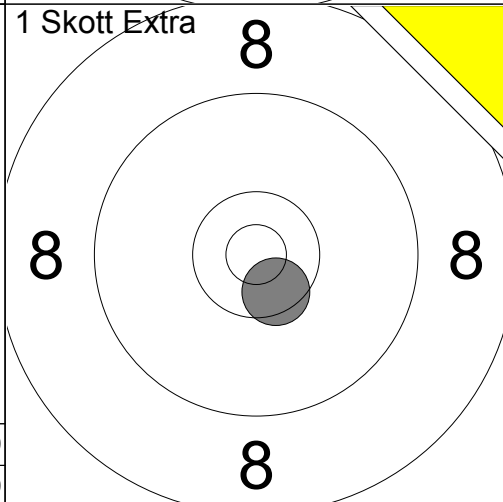

1:	10.5x	↘
----	-------	---

Serie	10.0
Total	336.0

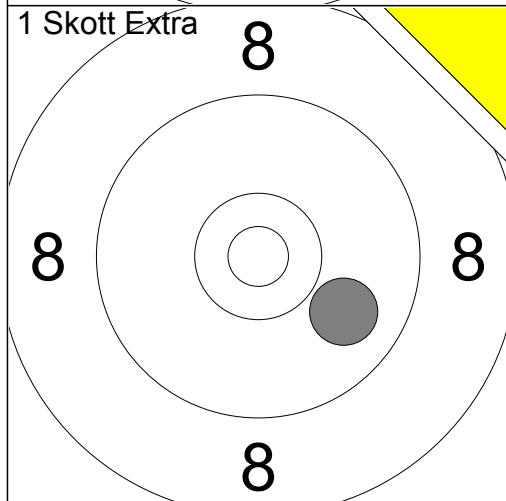

1:	9.9	↘
----	-----	---

Serie	9.0
Total	336.0

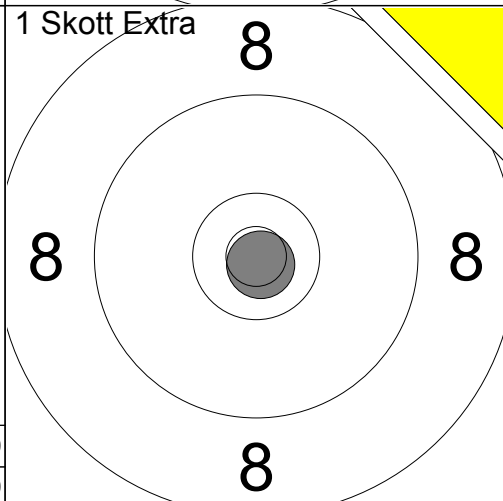

1:	10.9x	↘
----	-------	---

Serie	10.0
Total	336.0

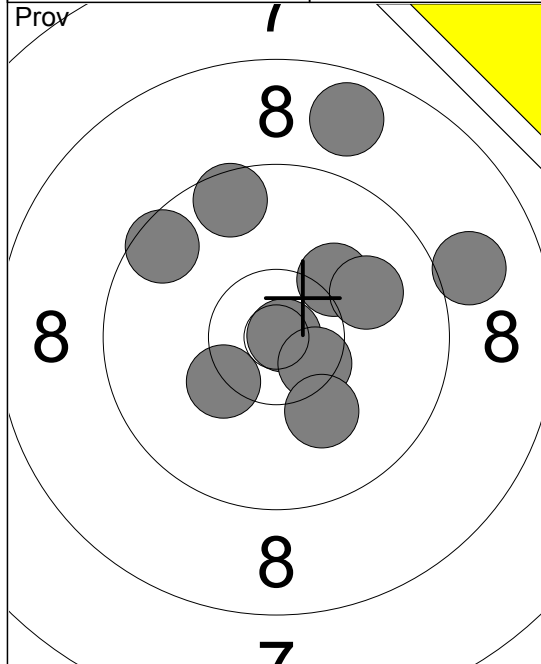

Prov

1:	10.9x	➤
2:	8.8	↗
3:	10.5x	↘
4:	10.2	↗
5:	10.0	➤
6:	9.0	➤
7:	9.6	↖
8:	9.6	↗
9:	10.3x	↘
10:	10.1	↘
Serie	95.0	
Total	189.0	

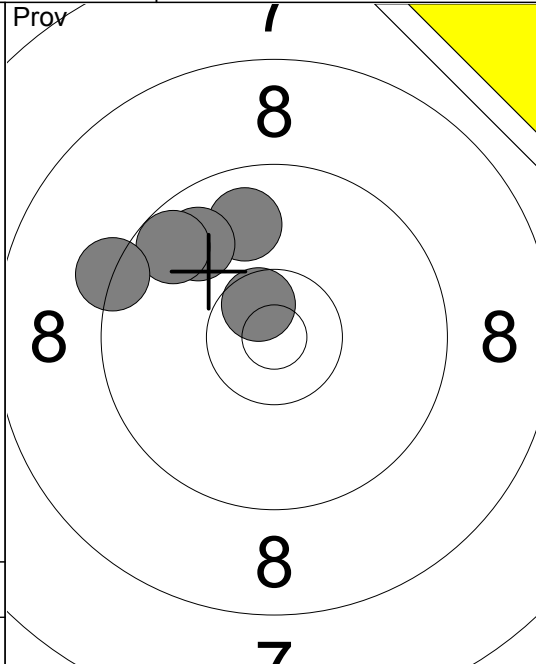

Prov

11:	9.8	↗
12:	9.8	↖
13:	10.6x	↗
14:	9.7	↖
15:	9.3	↖
Serie	46.0	
Total	189.0	

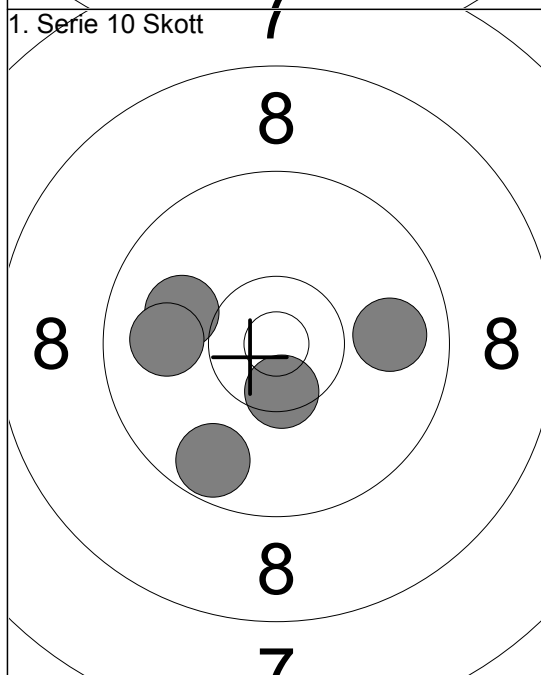

1. Serie 10 Skott

1:	10.0	↖
2:	9.9	➤
3:	10.5x	↘
4:	9.9	↖
5:	9.7	↘
Serie	47.0	
Total	236.0	

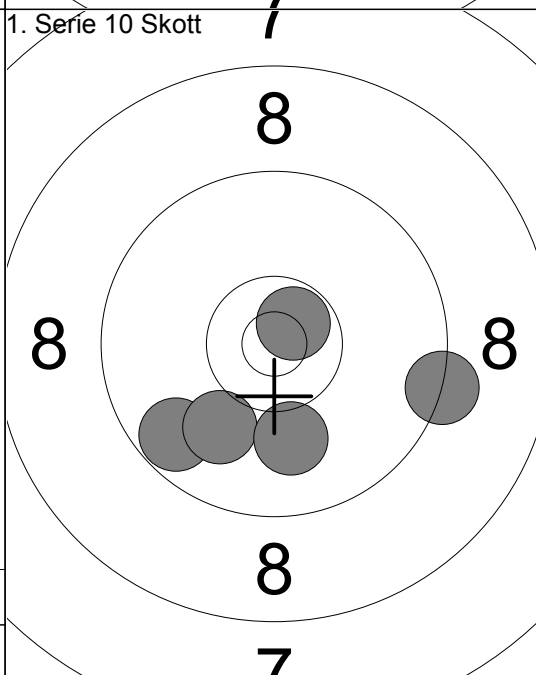

1. Serie 10 Skott

6:	9.7	↘
7:	10.7x	↗
8:	10.0	↘
9:	10.0	↘
10:	9.3	➤
Serie	48.0	
Total	284.0	

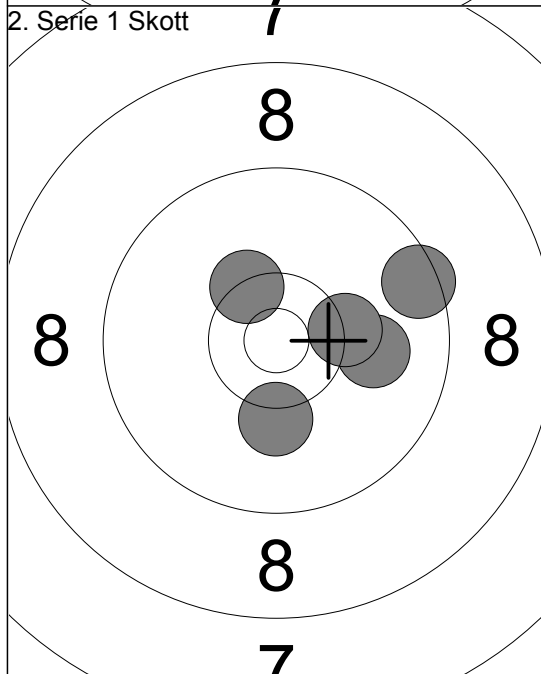

2. Serie 1 Skott

1:	10.0	➤
2:	10.4x	↘
3:	10.2	↘
4:	9.5	➤
5:	10.3x	➤
Serie	49.0	
Total	333.0	

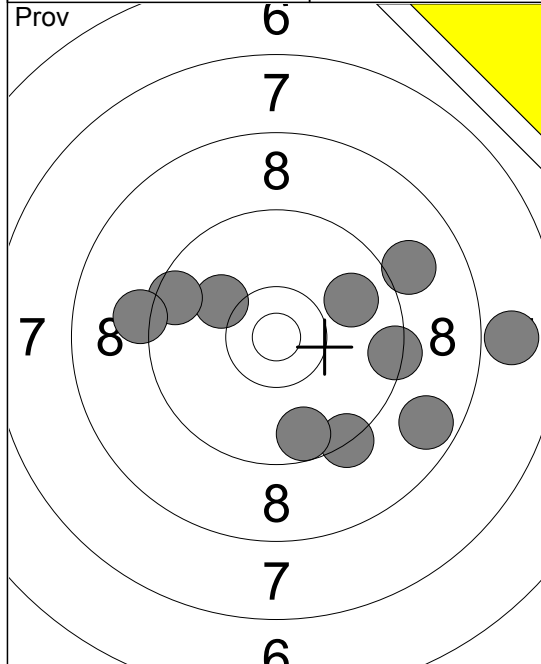

1:	9.0	↗
2:	7.9	→
3:	9.9	↗
4:	10.1	↖
5:	9.5	↖
6:	8.7	↘
7:	9.4	→
8:	9.3	↘
9:	9.7	↘
10:	9.2	↖
Serie	88.0	
Total	189.0	

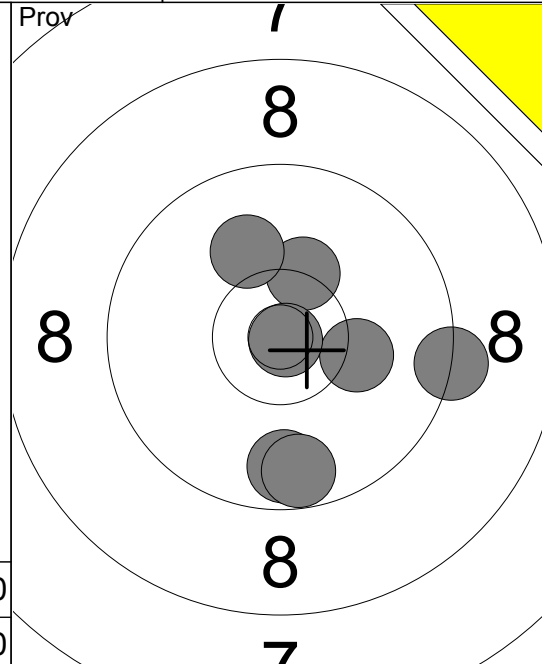

11:	10.3x	↗
12:	9.7	↘
13:	9.7	↘
14:	10.2	↗
15:	9.3	→
16:	10.9x	↘
17:	10.1	↖
Serie	67.0	
Total	189.0	

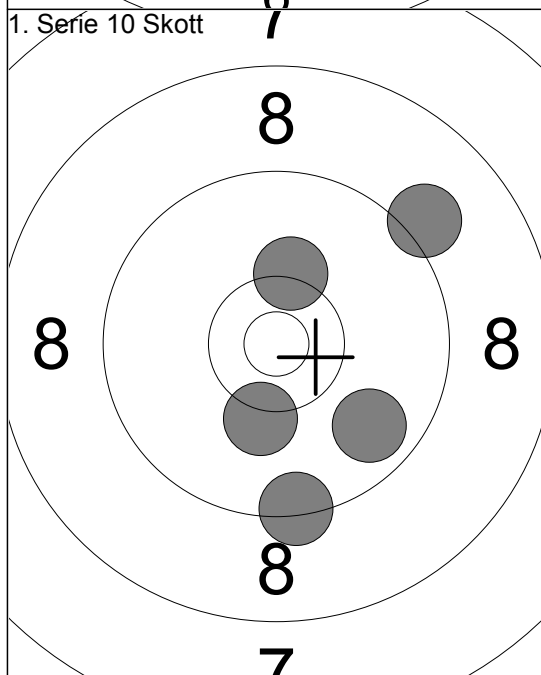

1:	10.2	↘
2:	9.8	↘
3:	10.3	↗
4:	9.1	↗
5:	9.4	↘
Serie	47.0	
Total	236.0	

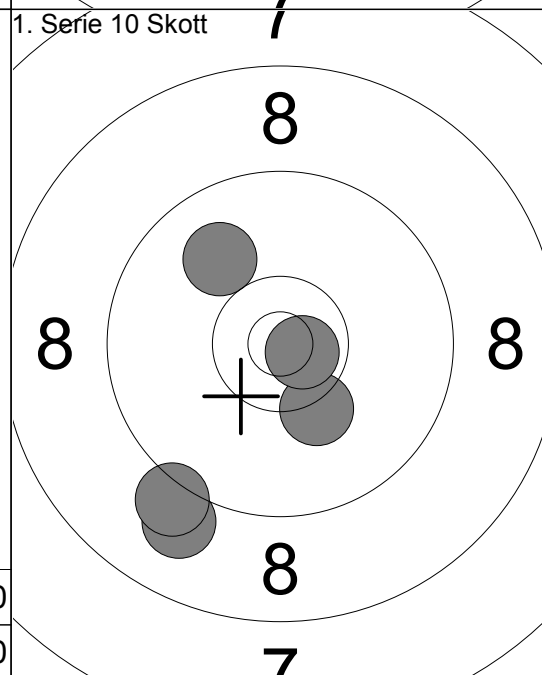

6:	10.2	↘
7:	9.0	↘
8:	9.1	↘
9:	10.0	↖
10:	10.7x	↘
Serie	48.0	
Total	284.0	

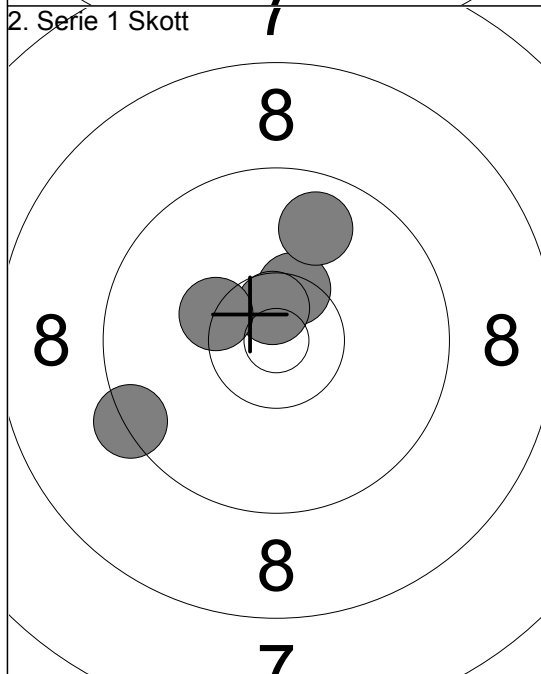

1:	10.4x	↗
2:	10.6x	↗
3:	9.8	↗
4:	10.3x	↘
5:	9.4	↖
Serie	48.0	
Total	332.0	



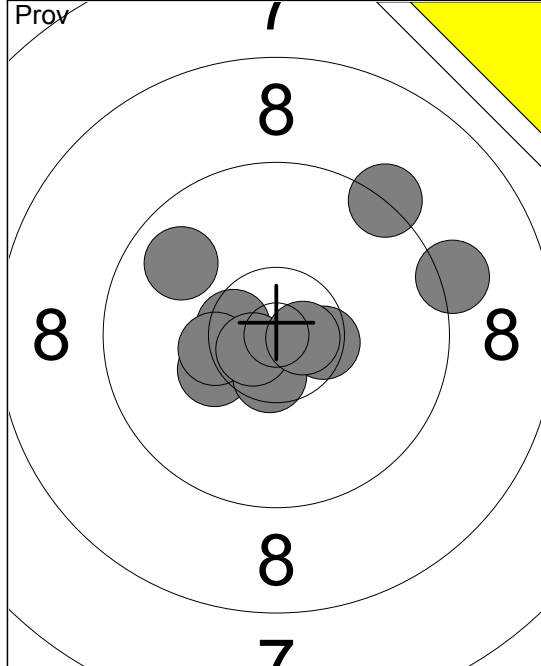

1:	9.3 ↗
2:	10.5x ➔
3:	10.3 ↙
4:	10.6x ↓
5:	10.5x ↘
6:	9.2 ➔
7:	10.3x ↘
8:	9.8 ↖
9:	10.7x ↙
10:	10.7x ➔
Serie 97.0	
Total 188.0	

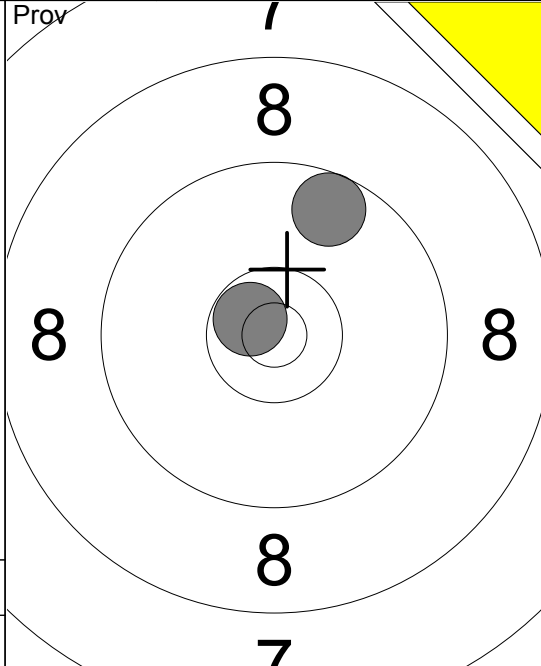

11:	9.6 ↗
12:	10.7x ↘
Serie 19.0	
Total 188.0	

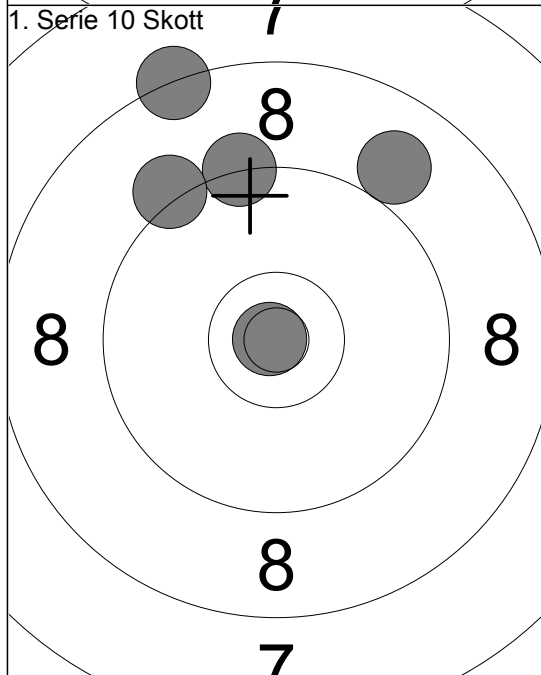

1:	9.0 ↗
2:	10.9x ↘
3:	8.3 ↗
4:	9.3 ↗
5:	9.2 ↗
Serie 45.0	
Total 233.0	

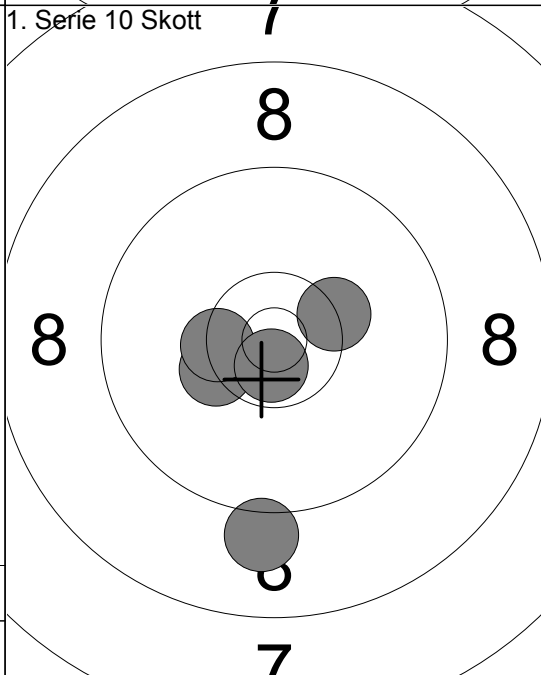

6:	10.3x ➔
7:	10.3x ↘
8:	10.4x ↘
9:	9.1 ↓
10:	10.7x ↓
Serie 49.0	
Total 282.0	

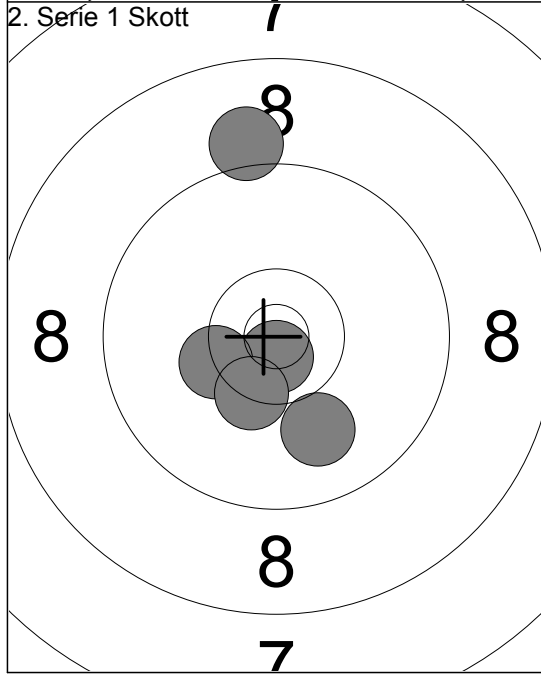

1:	9.1 ↗
2:	10.0 ↓
3:	10.8x ↓
4:	10.3x ↘
5:	10.4x ↓
Serie 49.0	
Total 331.0	

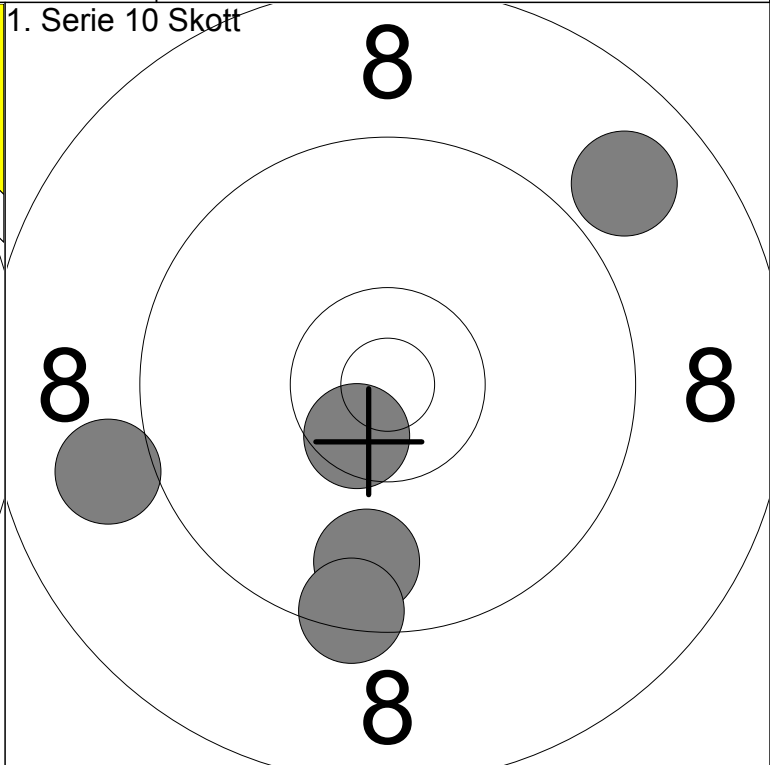
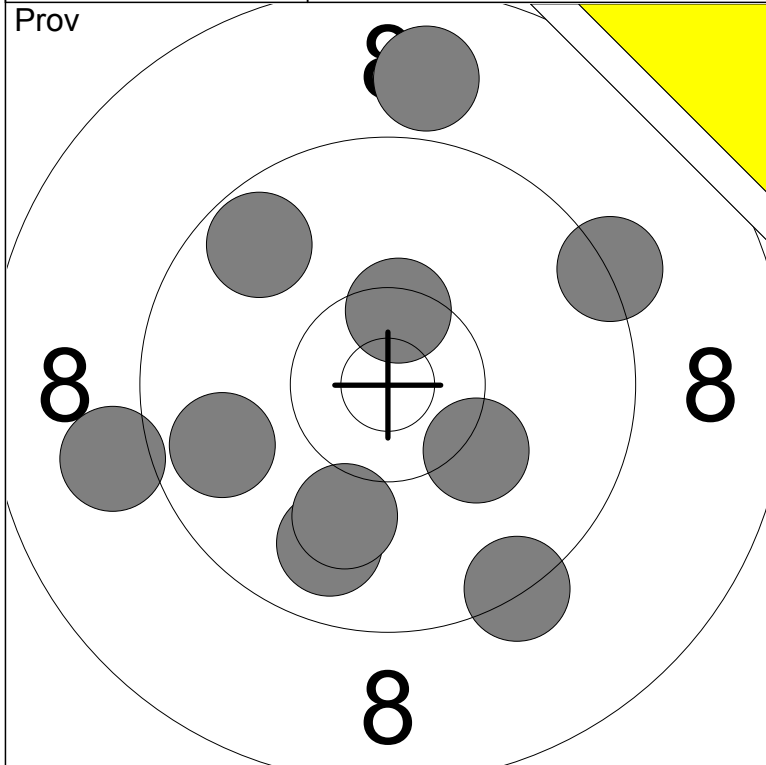

1: 9.8	↓	6: 9.3	↗	Serie	92
2: 9.1	←	7: 10.2	↘		
3: 10.0	↓	8: 8.9	↑	Total	180
4: 9.8	←	9: 10.5x	↑		
5: 9.3	↓	10: 9.7	↖		

1: 10.6x	↙	Serie	45
2: 9.0	←		
3: 9.8	↓	Total	225
4: 9.4	↓		
5: 8.9	↗		

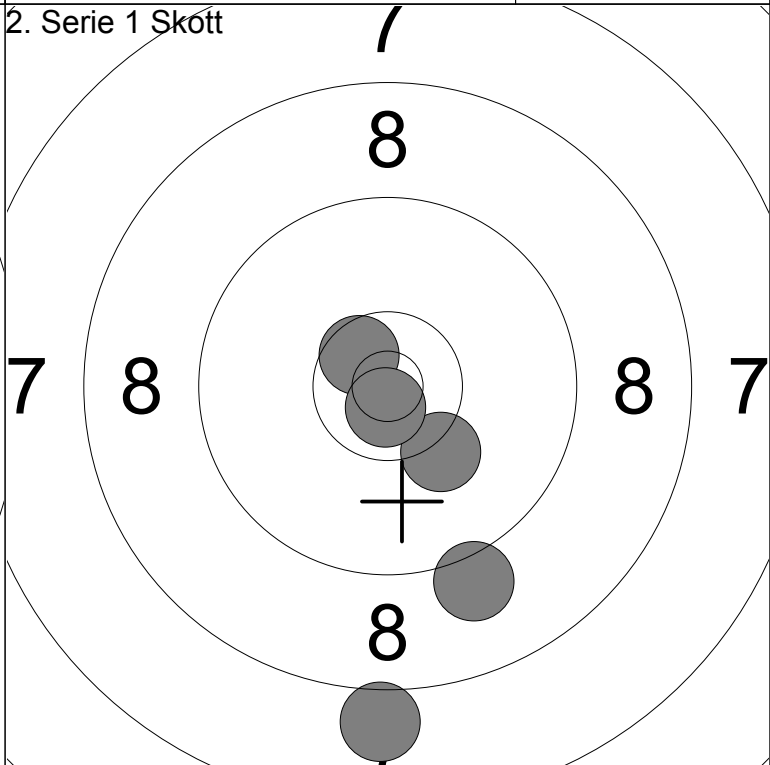
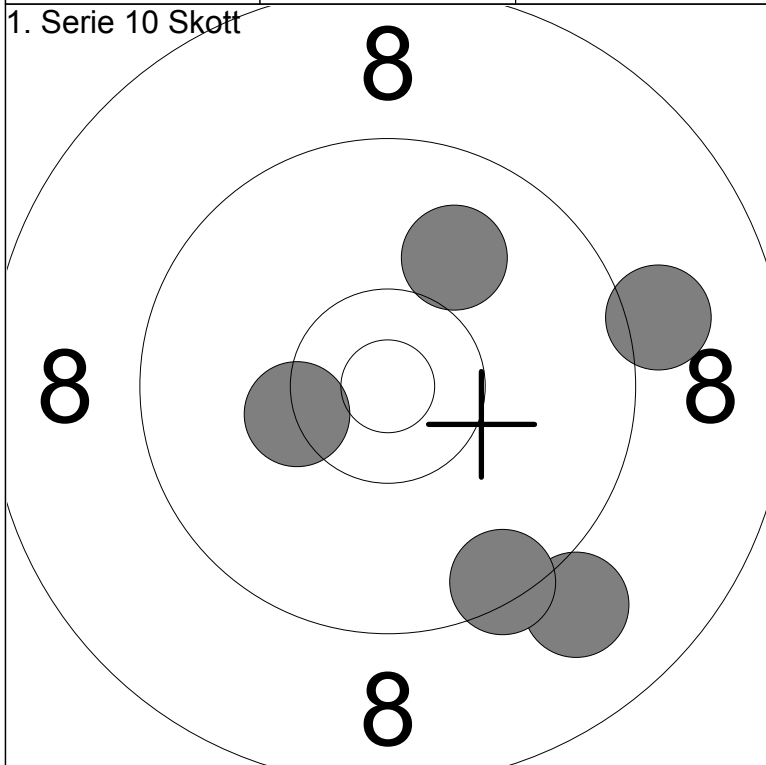

6: 9.0	↘	Serie	47
7: 10.0	↗		
8: 10.3x	←	Total	272
9: 9.1	→		
10: 9.4	↓		

1: 8.0	↓	Serie	47
2: 9.1	↘		
3: 10.2	↘	Total	319
4: 10.6x	↗		
5: 10.8x	↓		

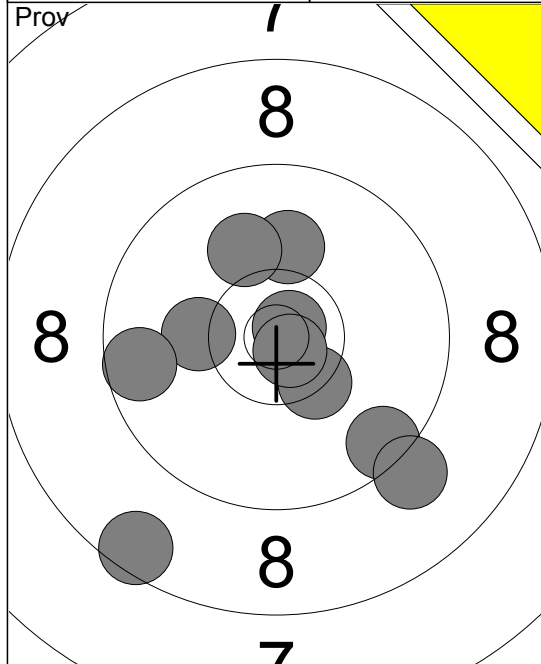

1:	8.5	↘
2:	10.2	←
3:	10.1	↑
4:	10.4	↘
5:	10.8	↗
6:	9.6	←
7:	9.5	↘
8:	10.8	↘
9:	9.1	↘
10:	10.1	↑
Serie	95.0	
Total	180.0	

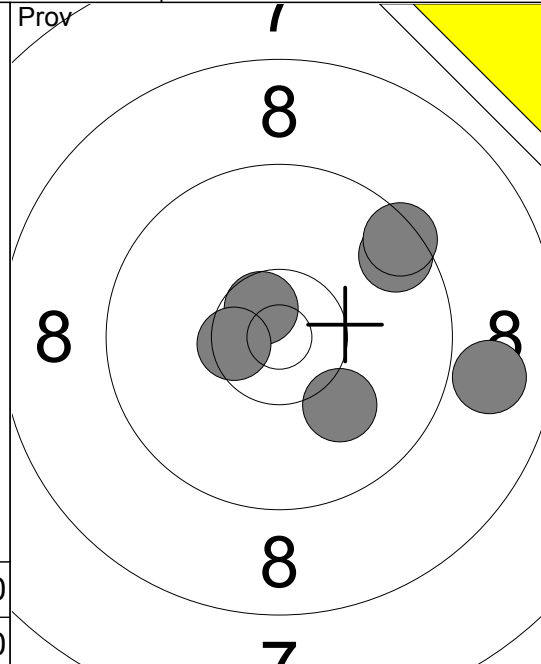

11:	9.6	↗
12:	8.9	→
13:	10.1	↘
14:	10.6	↘
15:	10.5	←
16:	9.5	↗
Serie	56.0	
Total	180.0	

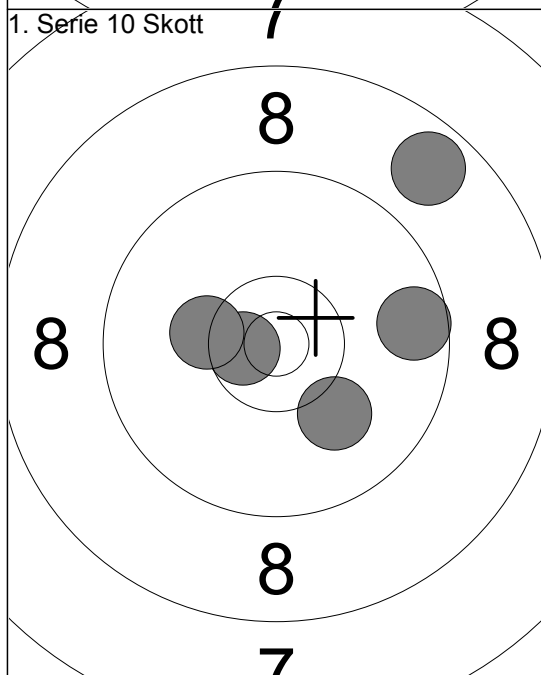

1:	8.7	↗
2:	9.6	→
3:	10.6	←
4:	10.1	↘
5:	10.3	←
Serie	47.0	
Total	227.0	

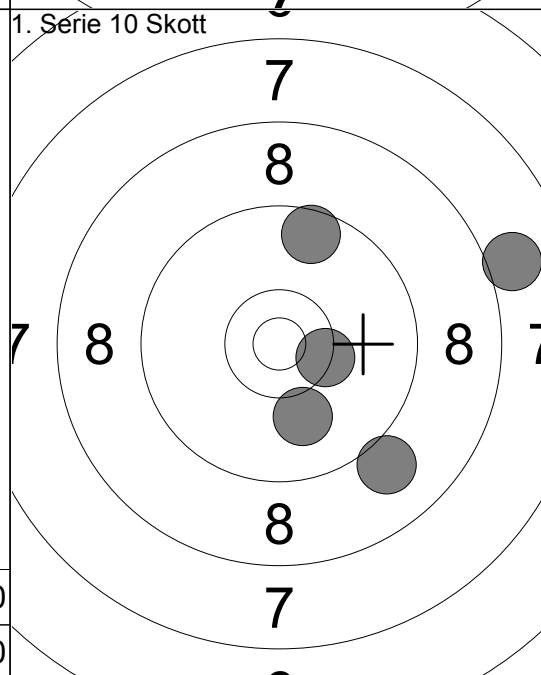

6:	9.0	↘
7:	9.6	↑
8:	8.0	→
9:	10.4	↘
10:	10.0	↘
Serie	46.0	
Total	273.0	

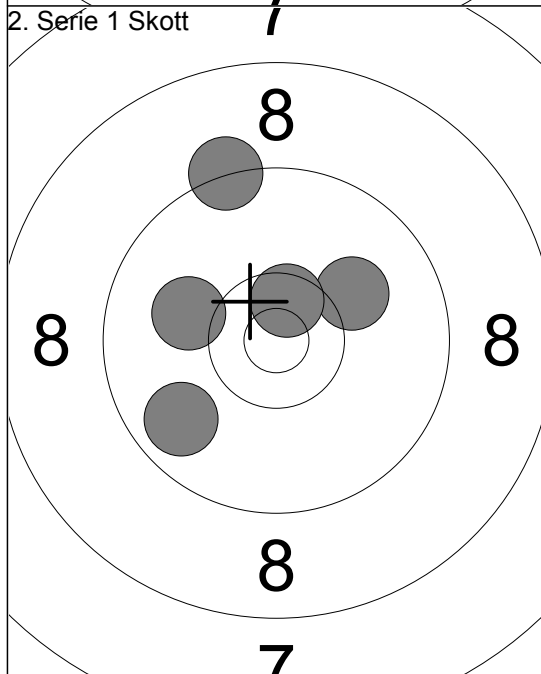

1:	10.1	←
2:	9.8	↙
3:	10.1	↗
4:	9.3	↑
5:	10.6	↗
Serie	48.0	
Total	321.0	

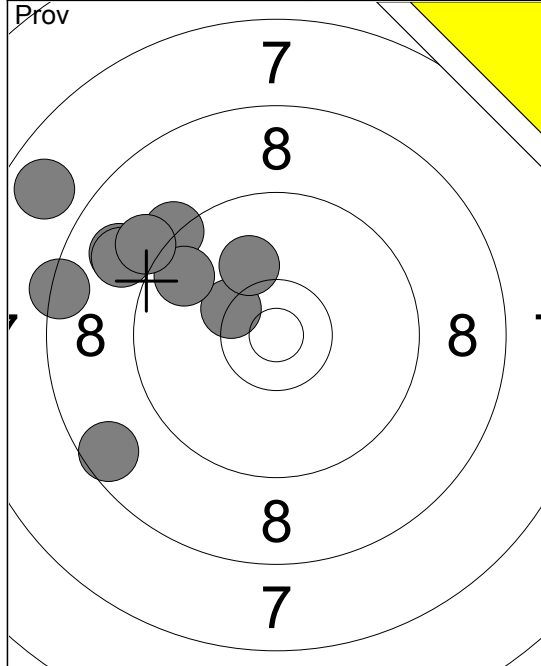

1:	10.3x ↘
2:	9.3 ↗
3:	8.9 ↗
4:	8.4 ←
5:	8.9 ↗
6:	10.1 ↗
7:	9.7 ↗
8:	9.1 ↗
9:	8.6 ↙
10:	7.8 ↙
Serie 86.0	
Total 180.0	

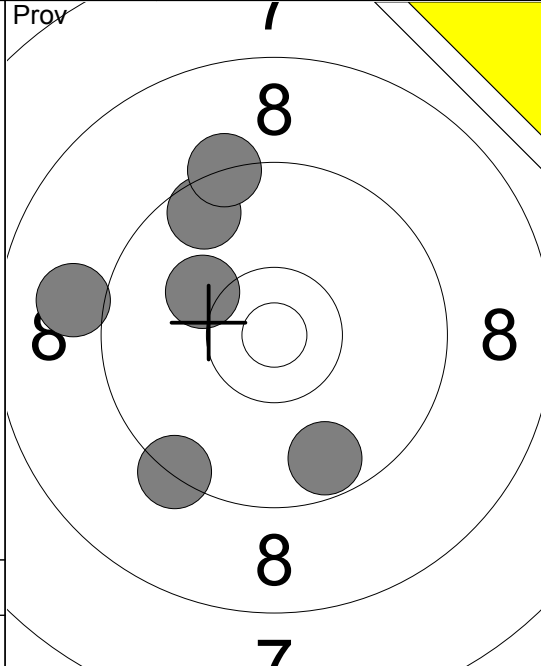

11:	9.0 ←
12:	9.6 ↗
13:	10.1 ↙
14:	9.7 ↘
15:	9.3 ↘
16:	9.3 ↗
Serie 55.0	
Total 180.0	

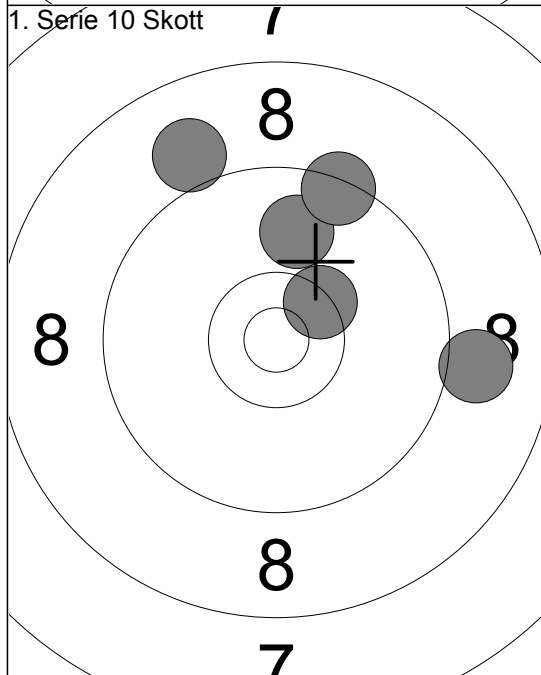

1:	9.9 ↗
2:	9.0 ↗
3:	9.0 →
4:	10.4x ↗
5:	9.4 ↗
Serie 46.0	
Total 226.0	

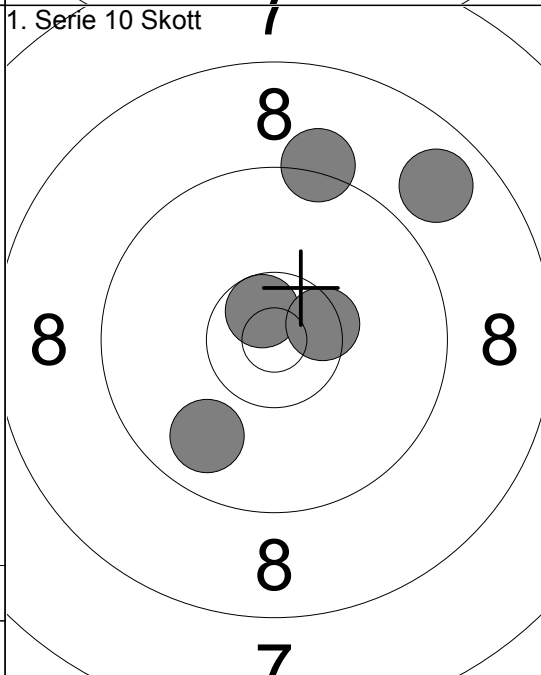

6:	10.7x ↘
7:	8.8 ↗
8:	9.2 ↗
9:	9.8 ↘
10:	10.5x ↗
Serie 46.0	
Total 272.0	

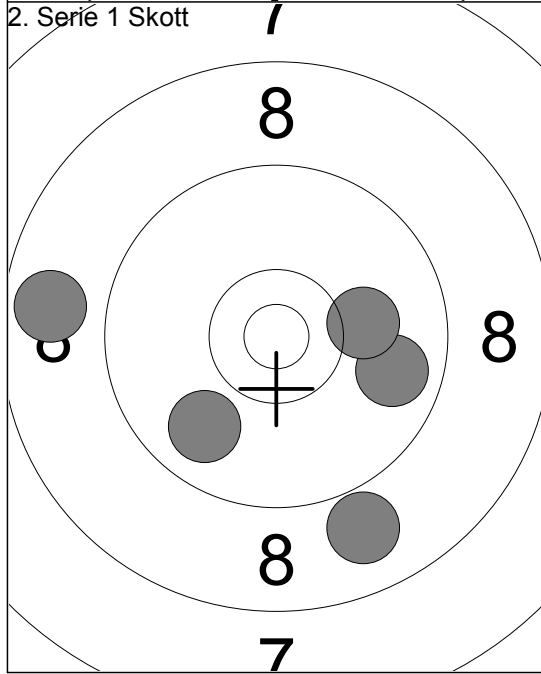

1:	9.8 ↘
2:	9.8 →
3:	8.8 ←
4:	8.9 ↘
5:	10.1 →
Serie 44.0	
Total 316.0	

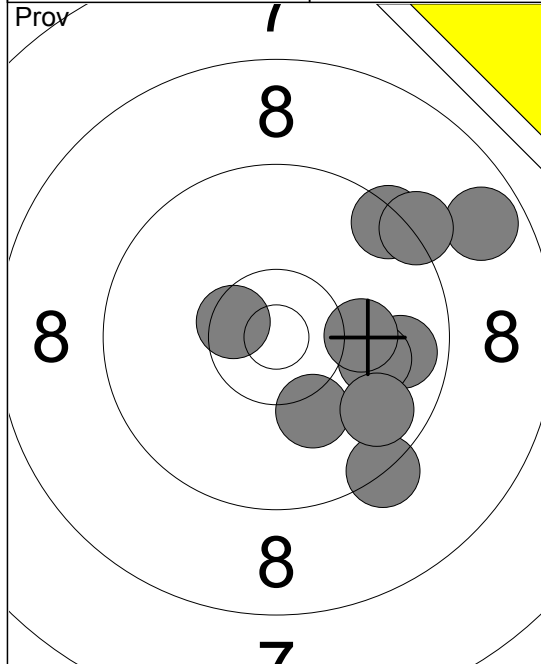

1:	8.7	↗
2:	9.8	→
3:	10.0	→
4:	9.4	↗
5:	10.1	→
6:	9.3	↗
7:	9.3	↘
8:	10.5	↖
9:	10.2	↘
10:	9.8	↘
Serie	93.0	
Total	193.0	

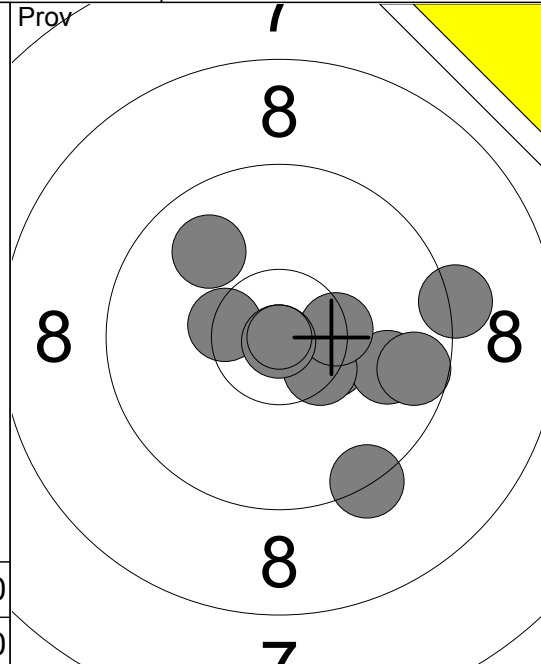

11:	10.4	↖
12:	9.3	↘
13:	9.9	→
14:	9.6	→
15:	10.5	↖
16:	9.2	→
17:	10.4	↖
18:	10.4	↗
19:	9.9	↗
20:	10.9	↘
Serie	95.0	
Total	193.0	

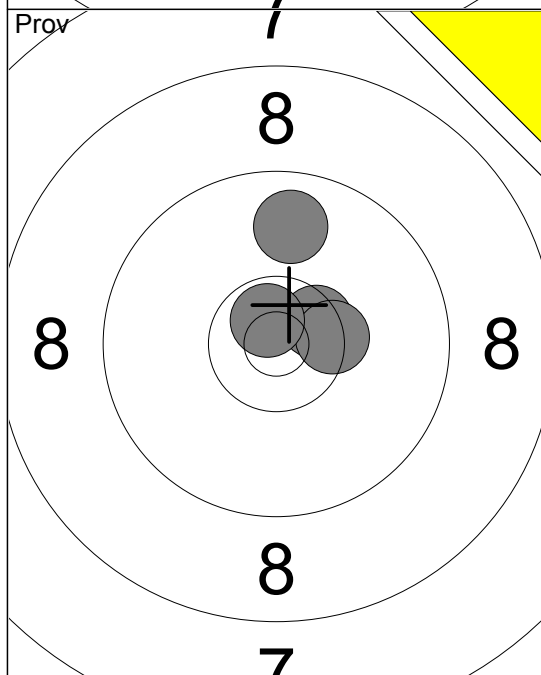

21:	10.5	↗
22:	10.4	↗
23:	9.8	↑
24:	10.7	↖
Serie	39.0	
Total	193.0	

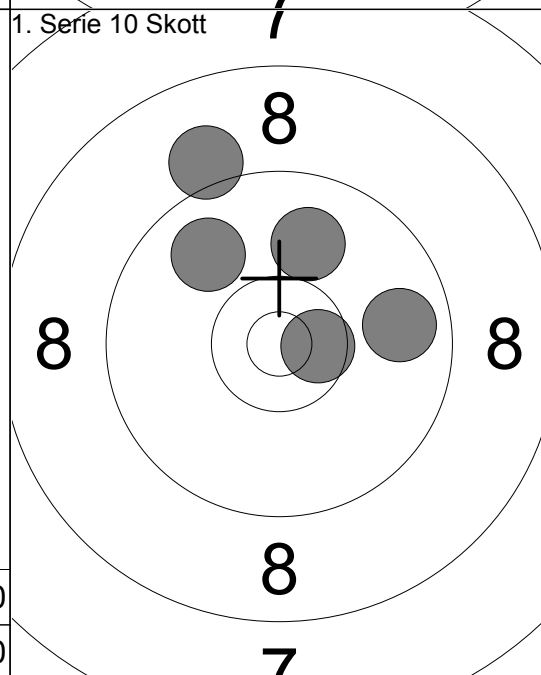

1:	9.8	→
2:	9.1	↗
3:	10.0	↑
4:	9.9	↖
5:	10.6	↗
Serie	47.0	
Total	240.0	

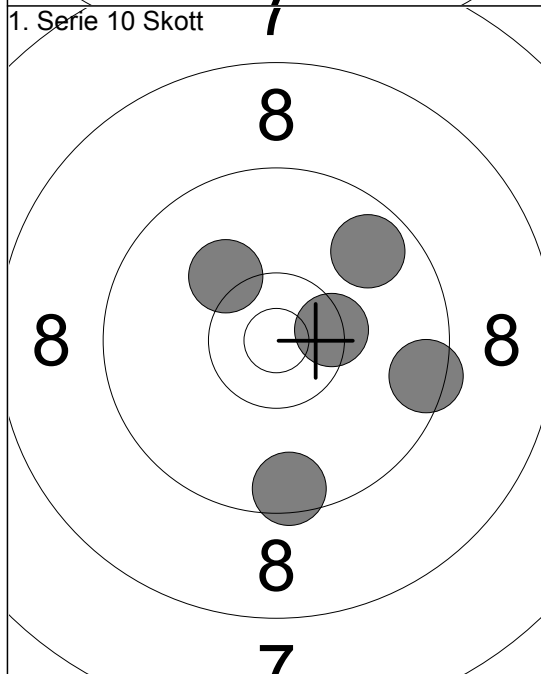

6:	9.7	↗
7:	9.5	↘
8:	10.2	↖
9:	9.5	→
10:	10.4	↗
Serie	47.0	
Total	287.0	

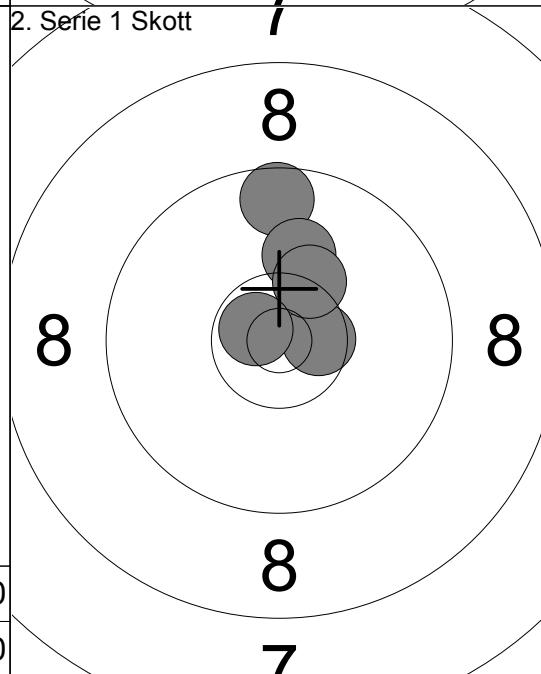

1:	9.6	↑
2:	10.6	↗
3:	10.1	↑
4:	10.3	↗
5:	10.7	↖
Serie	49.0	
Total	336.0	

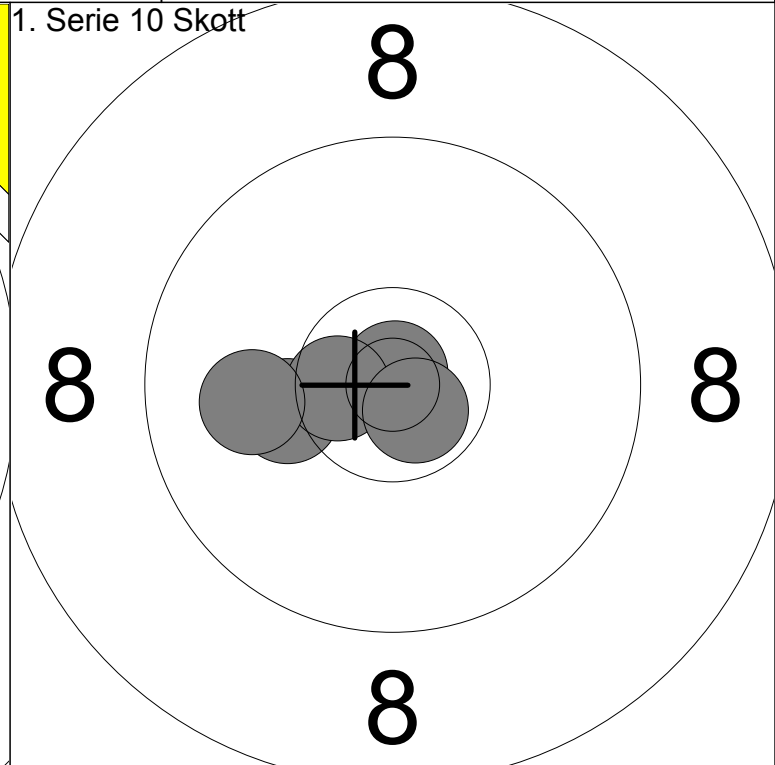
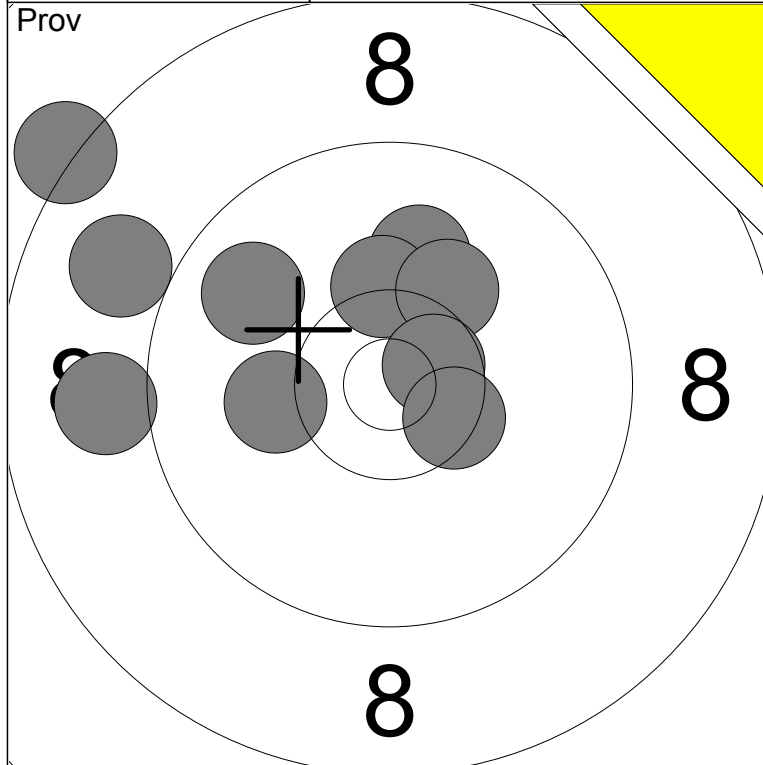

1: 8.2 ↖	6: 9.8 ↖	Serie	94
2: 8.9 ↖	7: 10.2 ←		
3: 10.1 ↑	8: 10.2 ↗	Total	191
4: 10.3 ↑	9: 10.6x →		
5: 9.0 ←	10: 10.5x ↘		

1: 10.9x ↑	Serie	50
2: 10.2 ←		
3: 10.6x ←	Total	241
4: 10.7x ↘		
5: 10.0 ←		

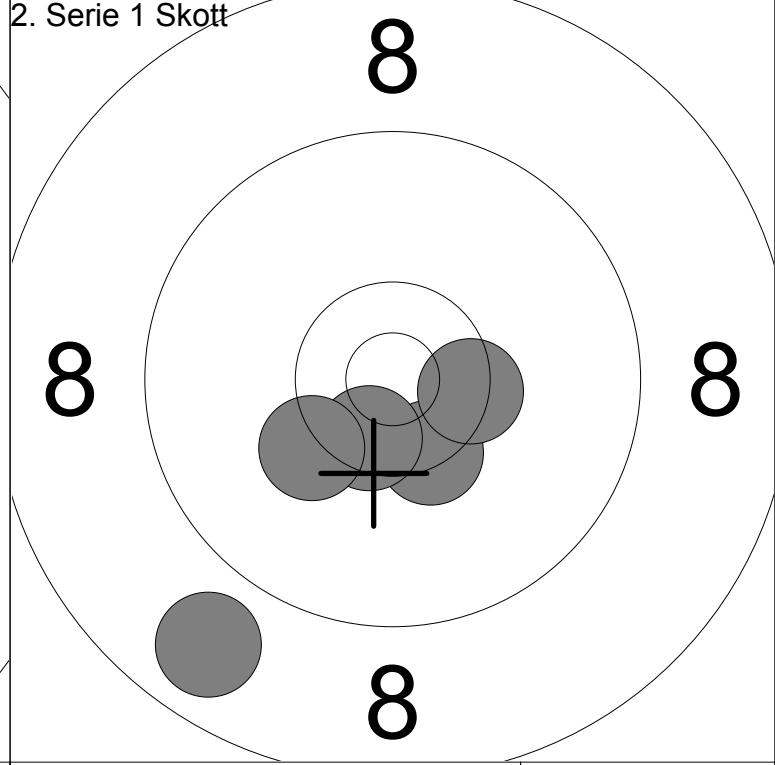
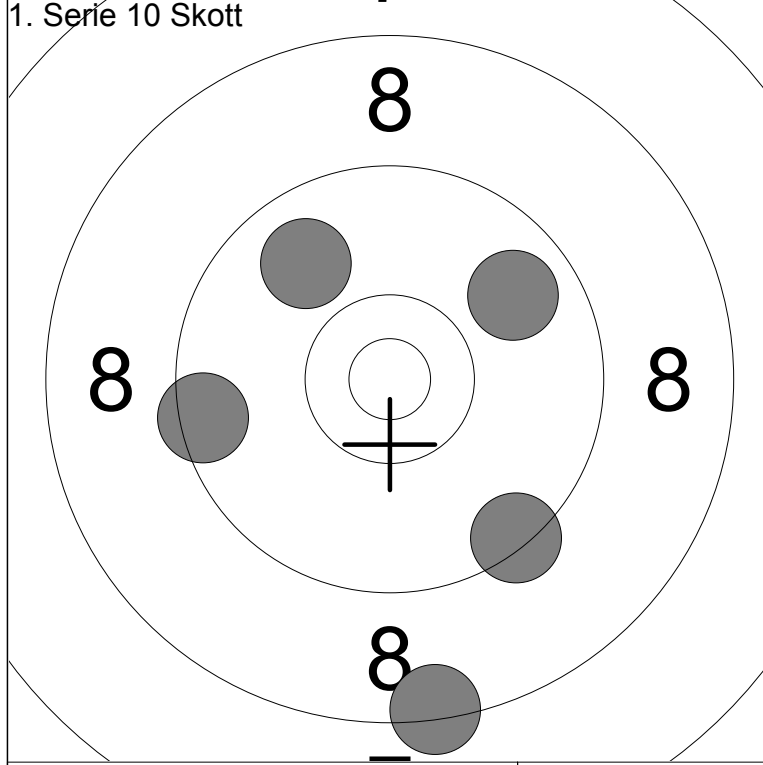

6: 8.4 ↓	Serie	44
7: 9.4 ↓		
8: 9.8 ↗	Total	285
9: 9.8 ↗		
10: 9.5 ←		

1: 8.8 ↘	Serie	48
2: 10.4x ↓		
3: 10.5x ↓	Total	333
4: 10.4x →		
5: 10.2 ↘		

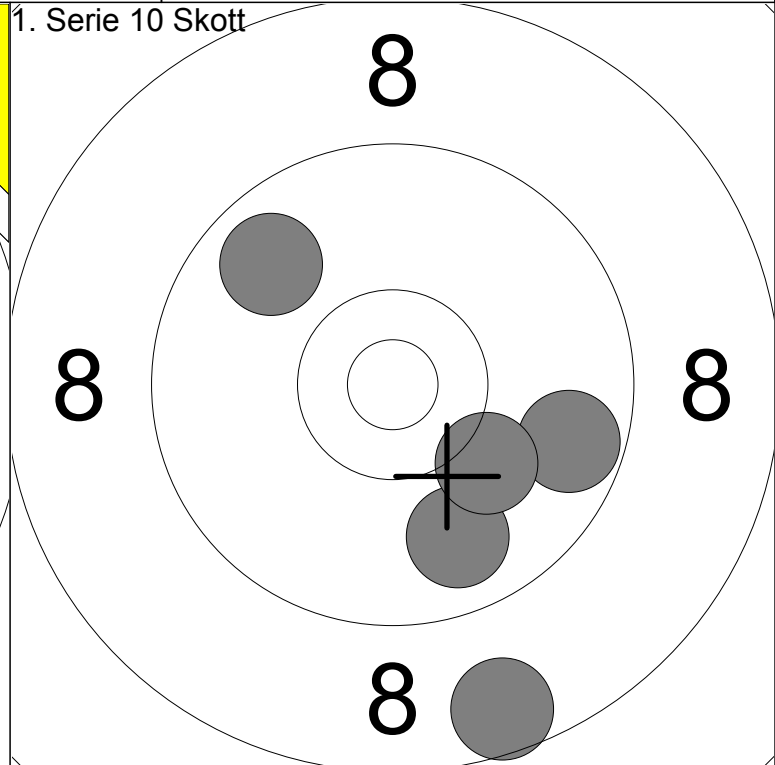
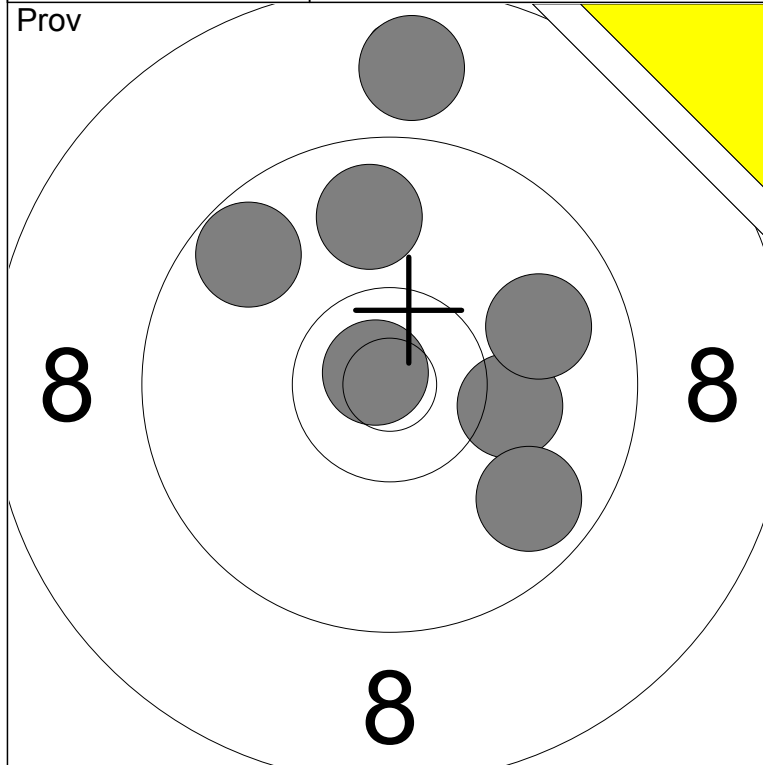

1: 9.8 ↑	6: 9.9 →	Serie	64
2: 10.8x ↗	7: 9.8 ↘		
3: 9.7 ↗		Total	190
4: 10.1 →			
5: 8.8 ↑			

1: 9.8 ↗	Serie	45
2: 9.8 ↘		
3: 9.7 ↘	Total	235
4: 10.1 ↘		
5: 8.6 ↘		

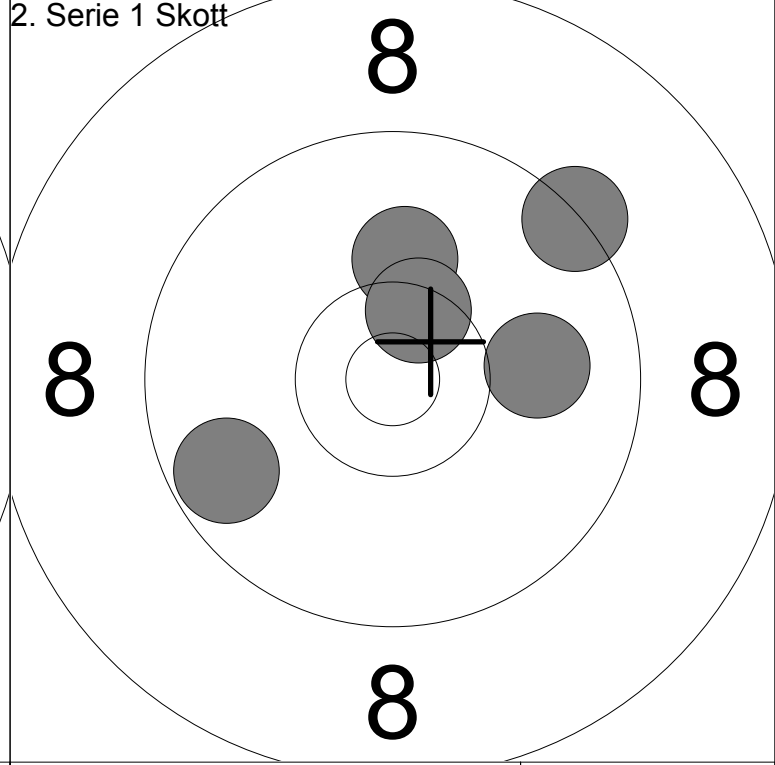
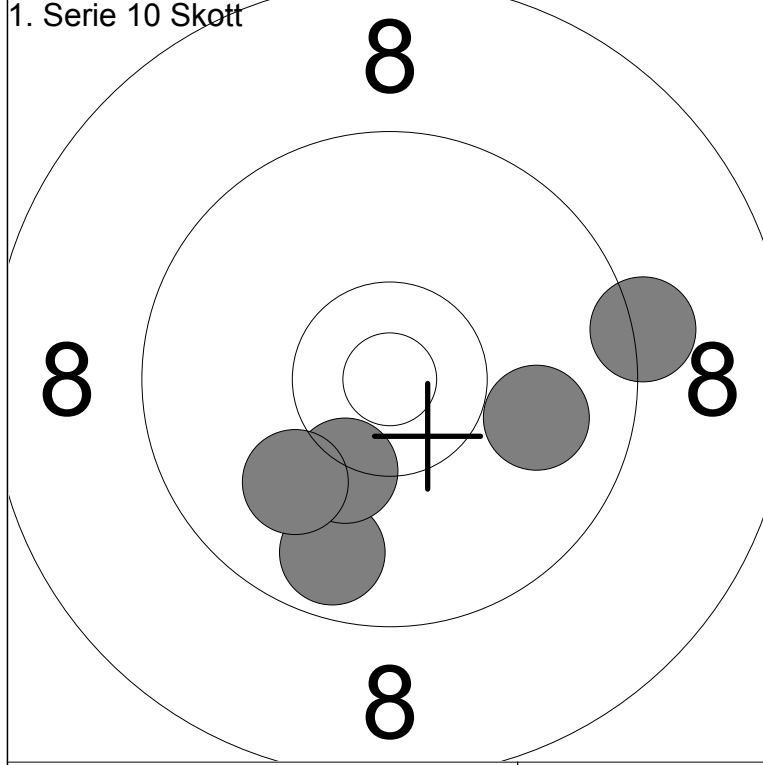

6: 9.7 ↓	Serie	47
7: 10.3 ↓		
8: 9.2 →	Total	282
9: 10.0 ↘		
10: 9.9 →		

1: 10.1 ↑	Serie	48
2: 9.3 ↗		
3: 10.5x ↑	Total	330
4: 9.7 ↙		
5: 10.0 →		

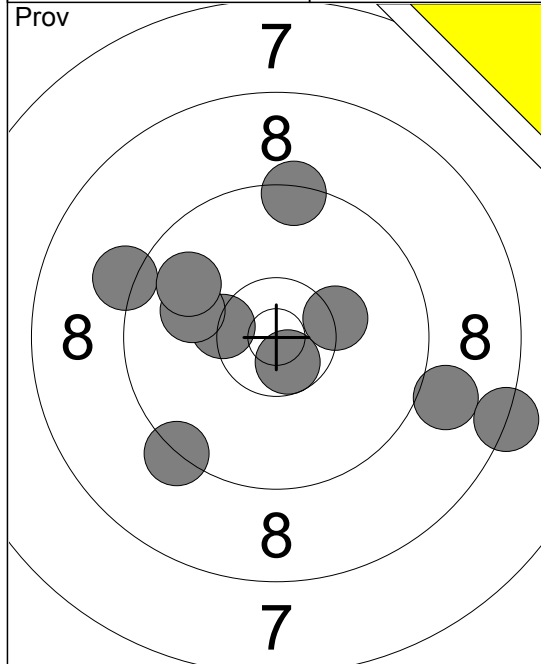

1:	9.4	↑
2:	10.4	↔
3:	10.7	↘
4:	10.0	↔
5:	9.2	↔
6:	9.0	↘
7:	8.3	↘
8:	9.8	↔
9:	10.3	↘
10:	9.3	↘
Serie		93.0
Total		186.0

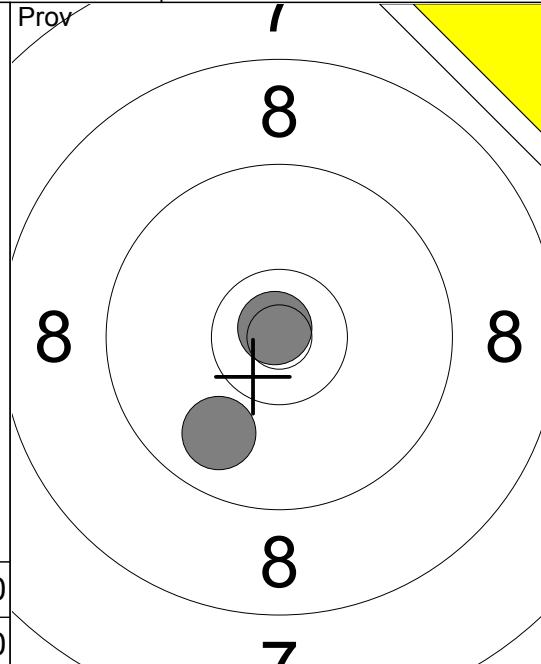

11:	10.9	↘
12:	9.9	↘
Serie		19.0
Total		186.0

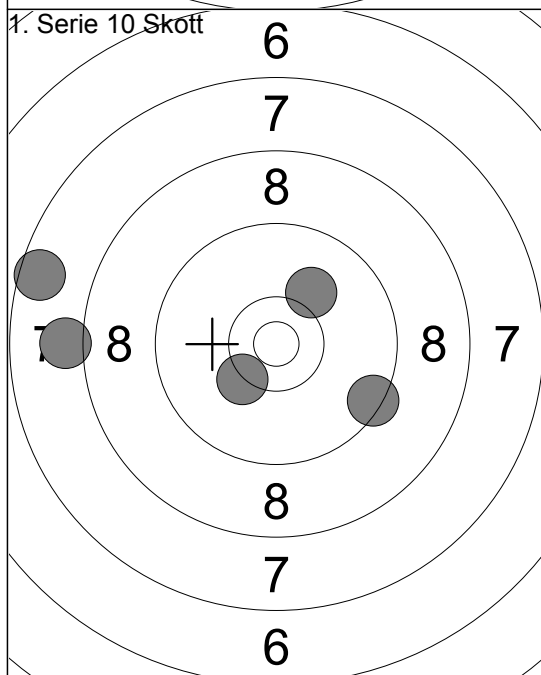

1:	10.1	↗
2:	10.3	↘
3:	9.4	↘
4:	8.1	↔
5:	7.6	↔
Serie		44.0
Total		230.0

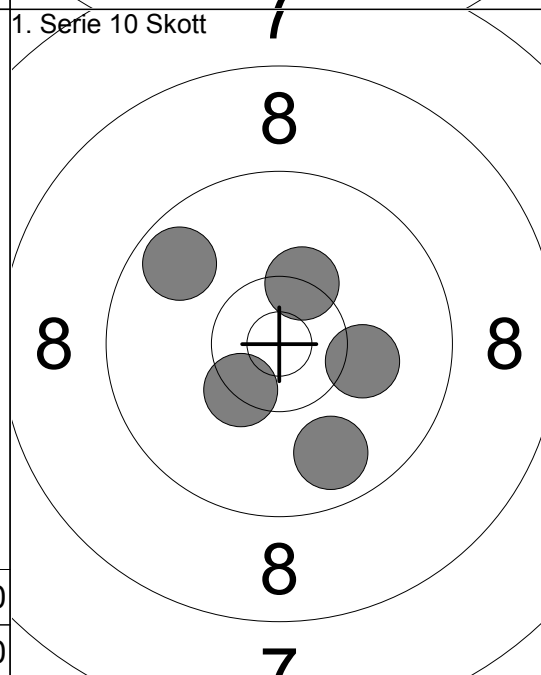

6:	10.4	↘
7:	9.8	↘
8:	9.7	↔
9:	10.1	↘
10:	10.3	↗
Serie		48.0
Total		278.0

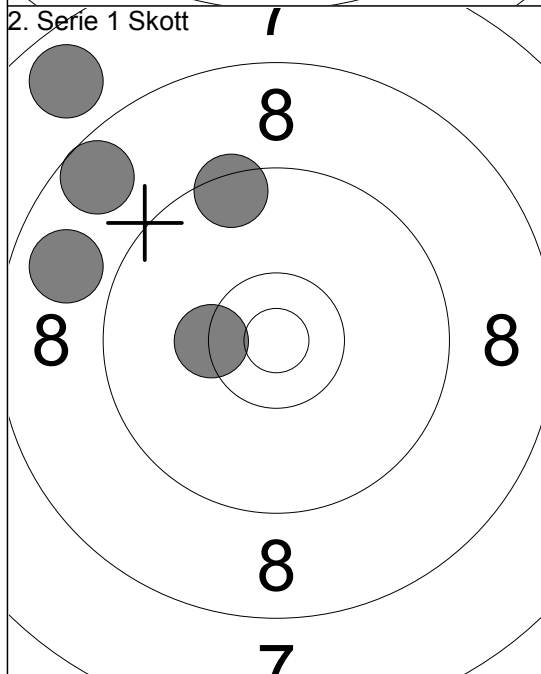

1:	9.5	↑
2:	7.8	↗
3:	8.6	↗
4:	8.8	↔
5:	10.3	↔
Serie		42.0
Total		320.0

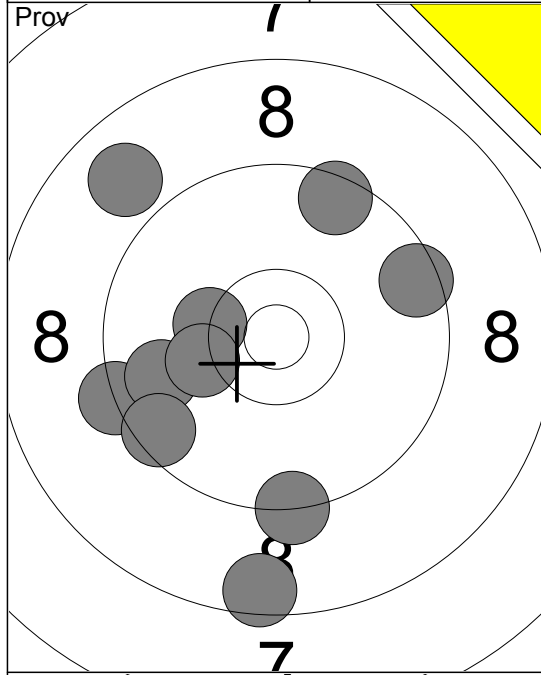

1:	10.3x
2:	9.3
3:	9.5
4:	8.9
5:	9.8
6:	9.3
7:	10.2
8:	8.5
9:	9.5
10:	9.5
Serie 90.0	
Total 179.0	

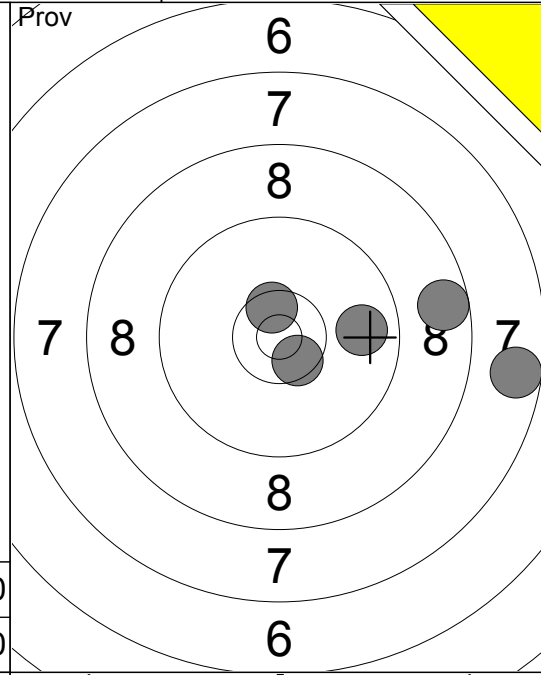

11:	9.8
12:	10.5x
13:	7.7
14:	8.7
15:	10.5x
Serie 44.0	
Total 179.0	

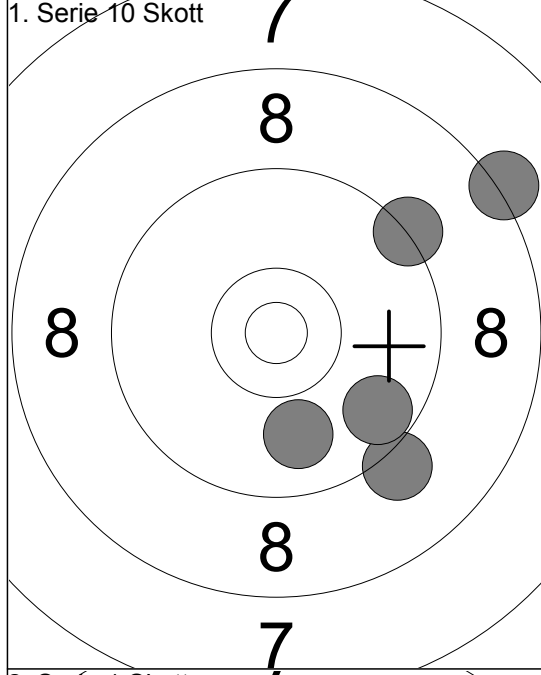

1:	9.9
2:	9.3
3:	9.2
4:	8.2
5:	9.7
Serie 44.0	
Total 223.0	

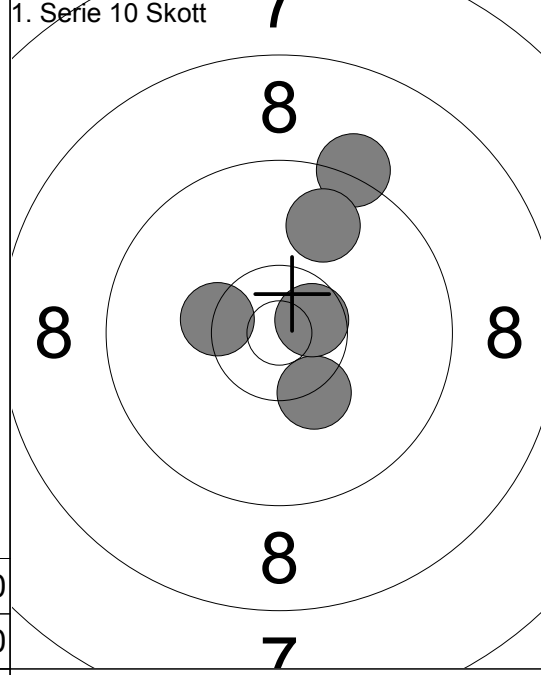

6:	10.3x
7:	10.3x
8:	9.2
9:	10.6x
10:	9.8
Serie 48.0	
Total 271.0	

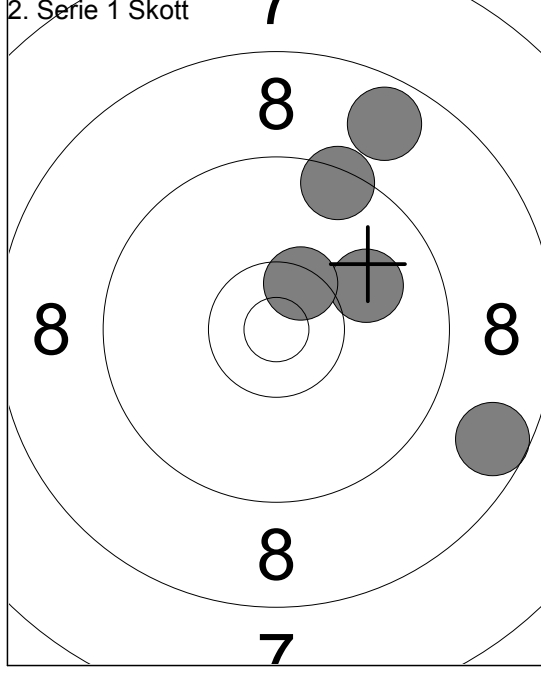

1:	9.4
2:	8.6
3:	8.7
4:	10.0
5:	10.5x
Serie 45.0	
Total 316.0	

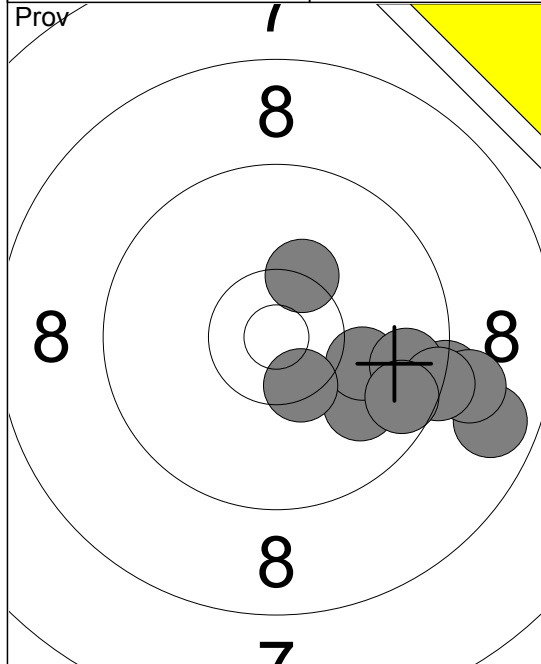

1:	9.9	↘
2:	10.1	→
3:	9.3	→
4:	8.8	→
5:	9.1	→
6:	9.7	→
7:	9.3	→
8:	9.6	↘
9:	10.4	↘
10:	10.3	↗
Serie		92.0
Total		193.0

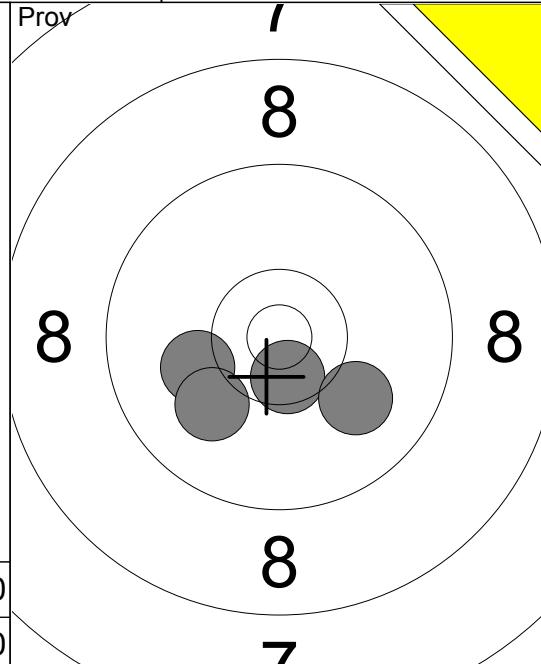

11:	10.1	←
12:	10.6	↘
13:	10.0	↘
14:	10.0	↘
Serie		40.0
Total		193.0

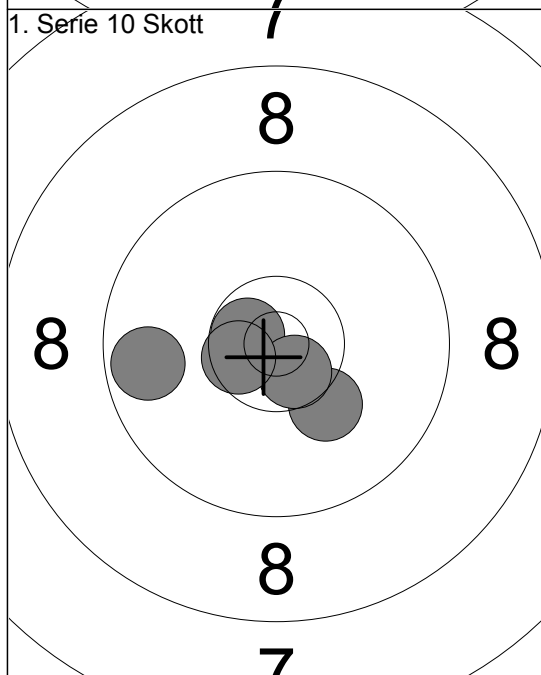

1. Serie 10 Skott		
1:	10.7	↘
2:	10.2	↘
3:	10.6	↘
4:	10.6	↘
5:	9.7	←
Serie		49.0
Total		242.0

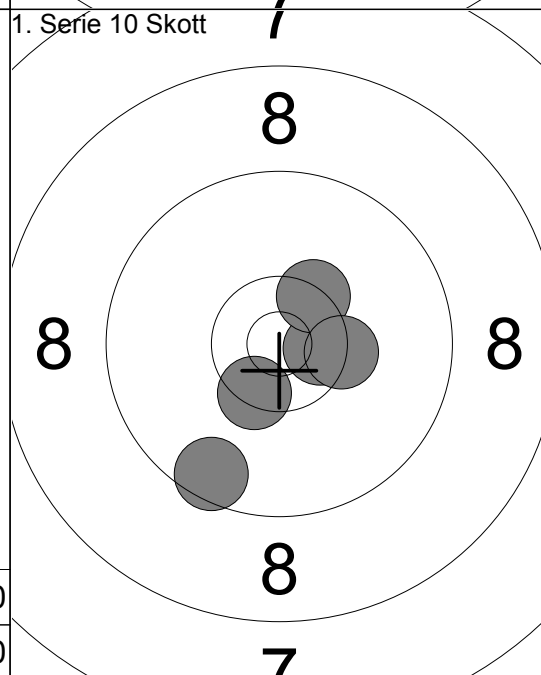

1. Serie 10 Skott		
6:	9.6	↘
7:	10.6	→
8:	10.4	↘
9:	10.4	↗
10:	10.4	→
Serie		49.0
Total		291.0

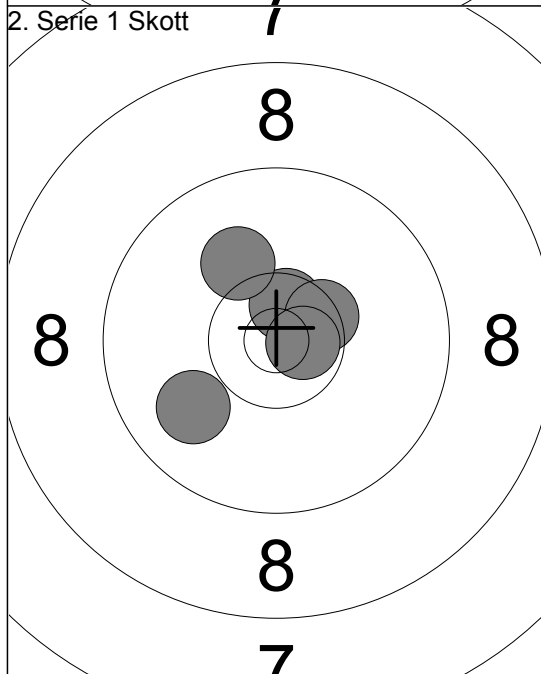

2. Serie 1 Skott		
1:	9.9	↙
2:	10.6	↗
3:	10.1	↖
4:	10.5	↗
5:	10.7	→
Serie		49.0
Total		340.0



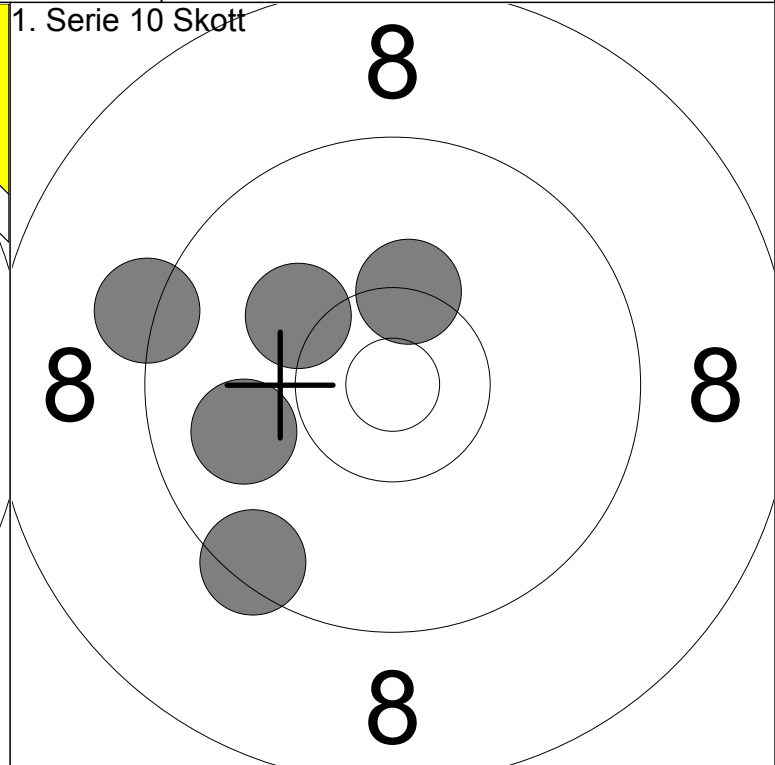
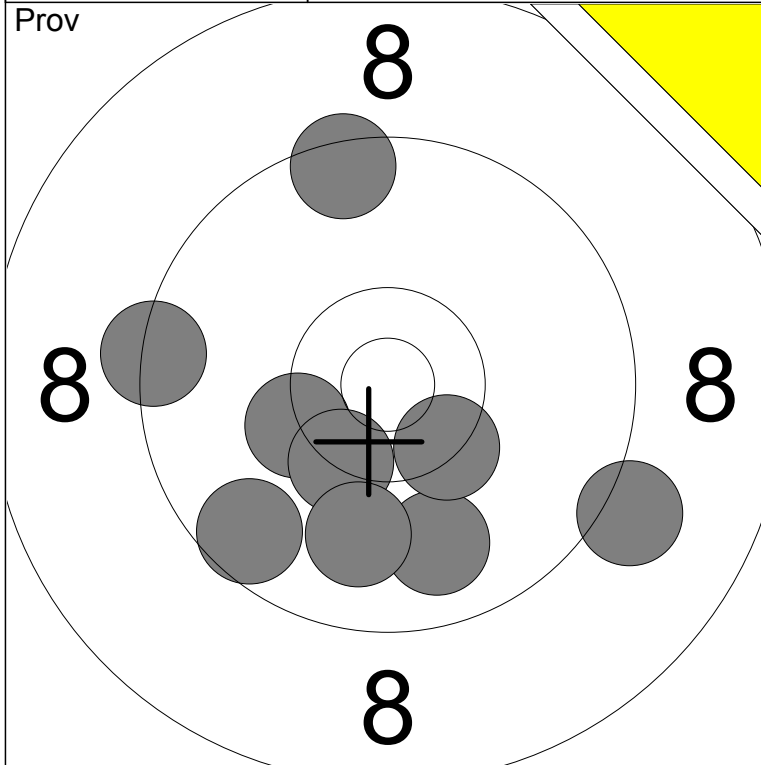

1: 9.9 ↓	6: 10.3x ↓	Serie	84
2: 10.4x ↓	7: 9.6 ↘		
3: 9.1 ↘	8: 9.4 ←	Total	190
4: 9.5 ↑	9: 9.9 ↓		
5: 10.3x ←			

1: 10.3x ↑	Serie	47
2: 10.2 ↖		
3: 9.4 ↘	Total	237
4: 9.9 ←		
5: 9.2 ←		

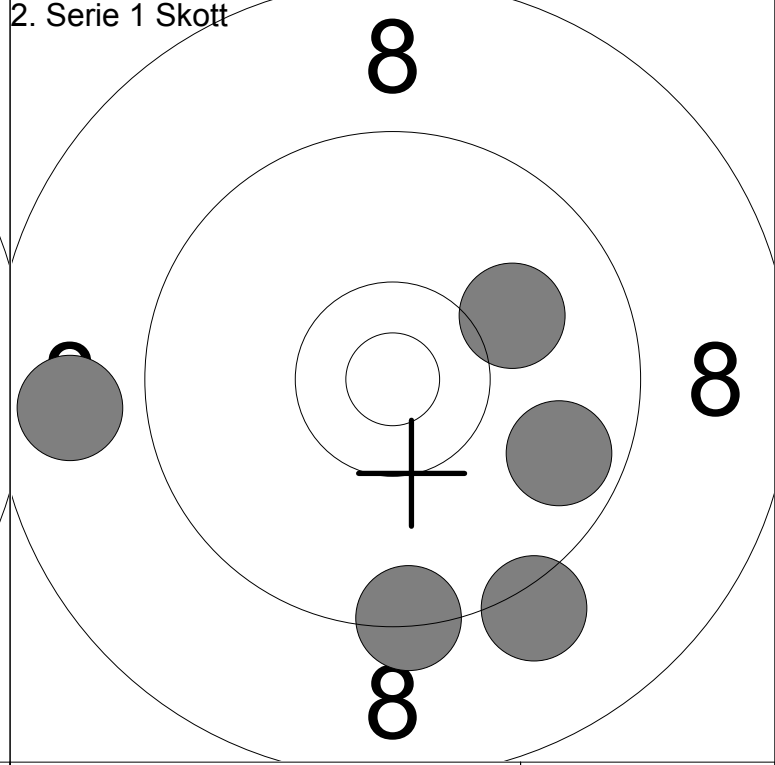
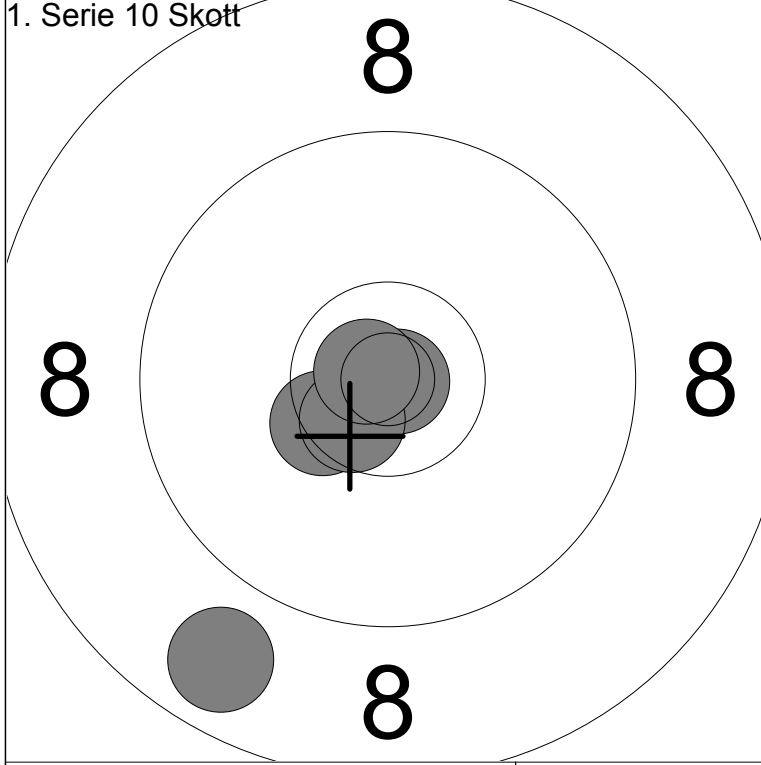

6: 10.4x ←	Serie	48
7: 8.8 ↓		
8: 10.9x →	Total	285
9: 10.6x ↘		
10: 10.8x ←		

1: 9.7 →	Serie	45
2: 9.4 ↓		
3: 10.0 ↗	Total	330
4: 9.2 ↘		
5: 8.8 ←		

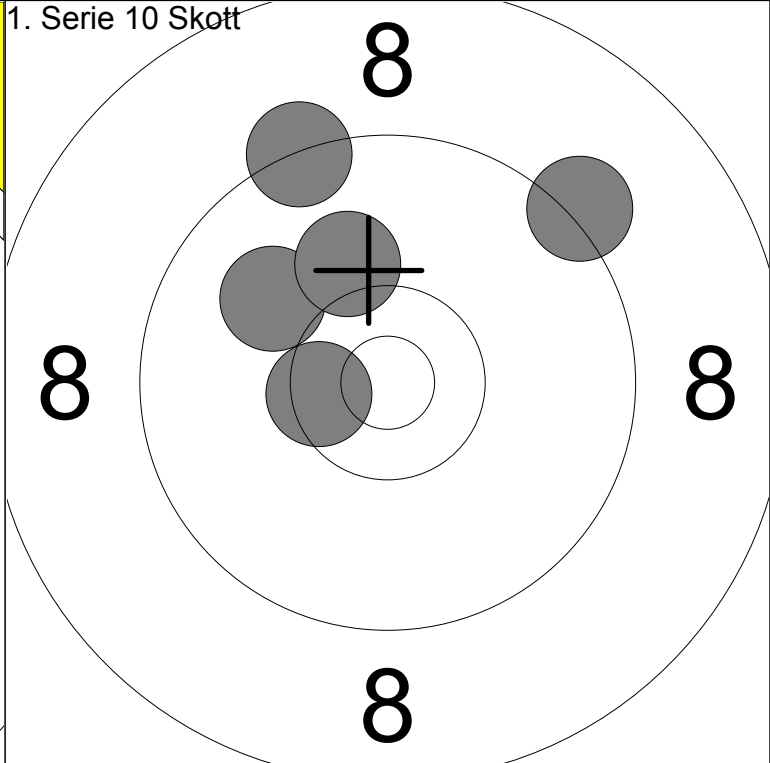
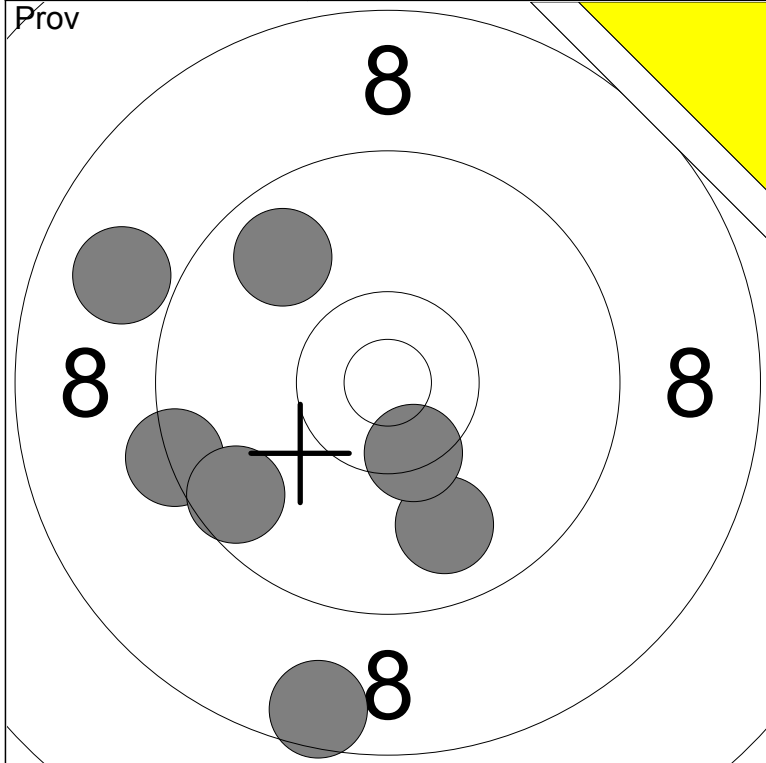

1: 9.8 ↗	6: 9.3 ←	Serie	62
2: 8.6 ↓	7: 9.6 ↙		
3: 8.9 ↗		Total	189
4: 9.9 ↓			
5: 10.4x ↓			

1: 10.0 ↖	Serie	48
2: 10.5x ←		
3: 9.3 ↗	Total	237
4: 9.2 ↗		
5: 10.1 ↗		

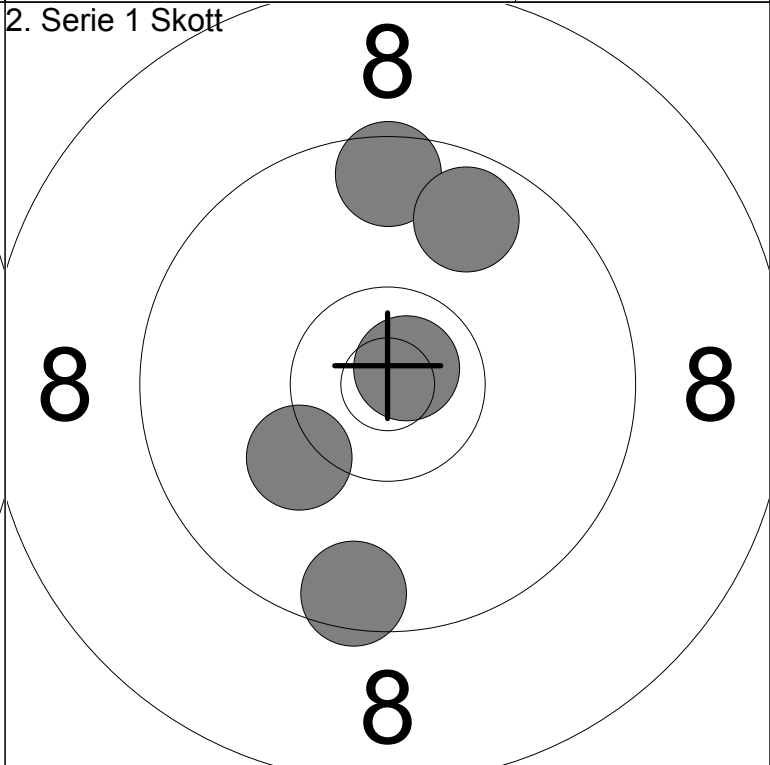
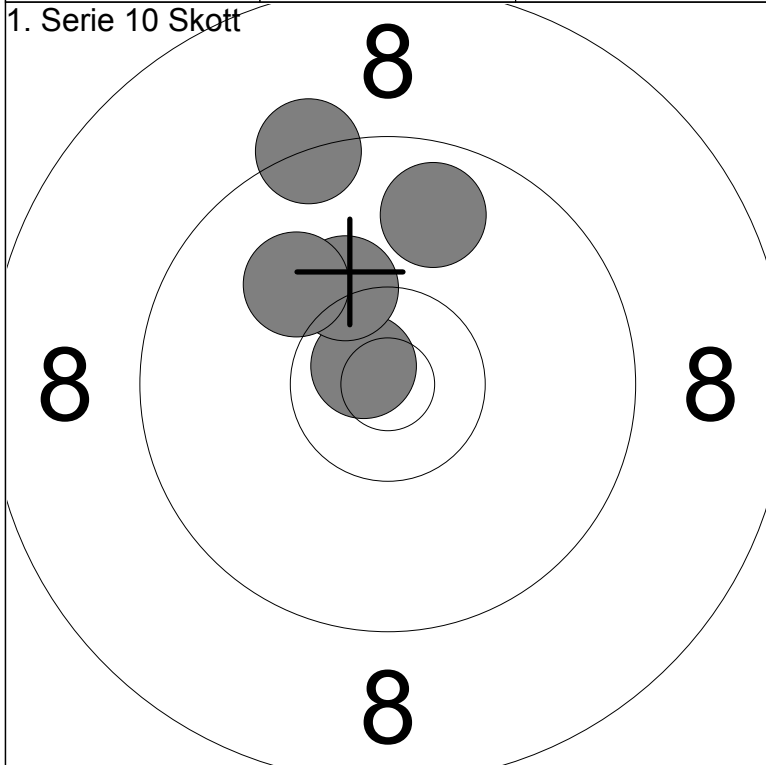

6: 10.7x ↖	Serie	48
7: 9.3 ↗		
8: 10.3 ↗	Total	285
9: 10.0 ↗		
10: 9.8 ↗		

1: 10.2 ↖	Serie	47
2: 9.5 ↓		
3: 10.8x ↗	Total	332
4: 9.5 ↑		
5: 9.7 ↗		

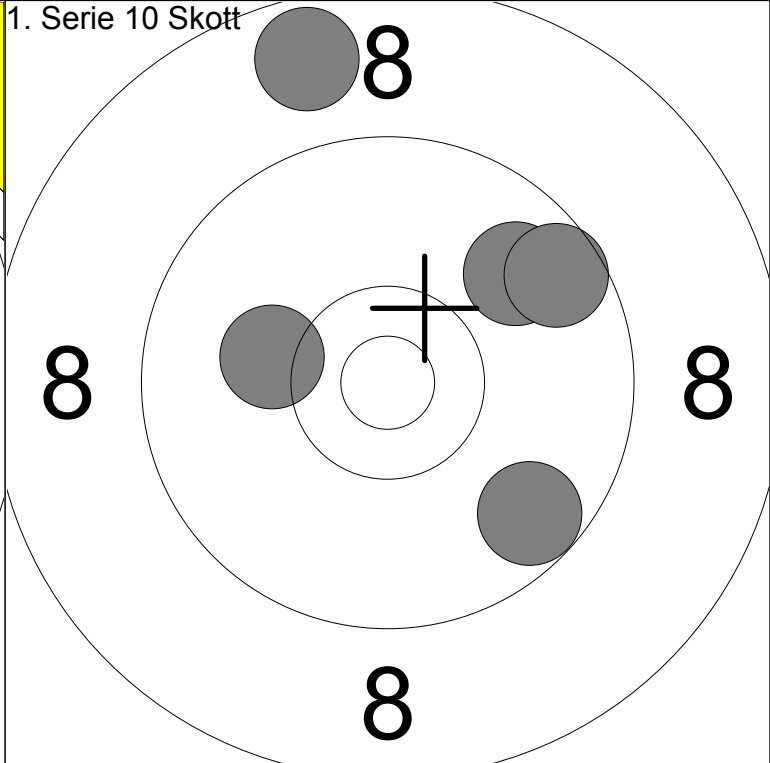
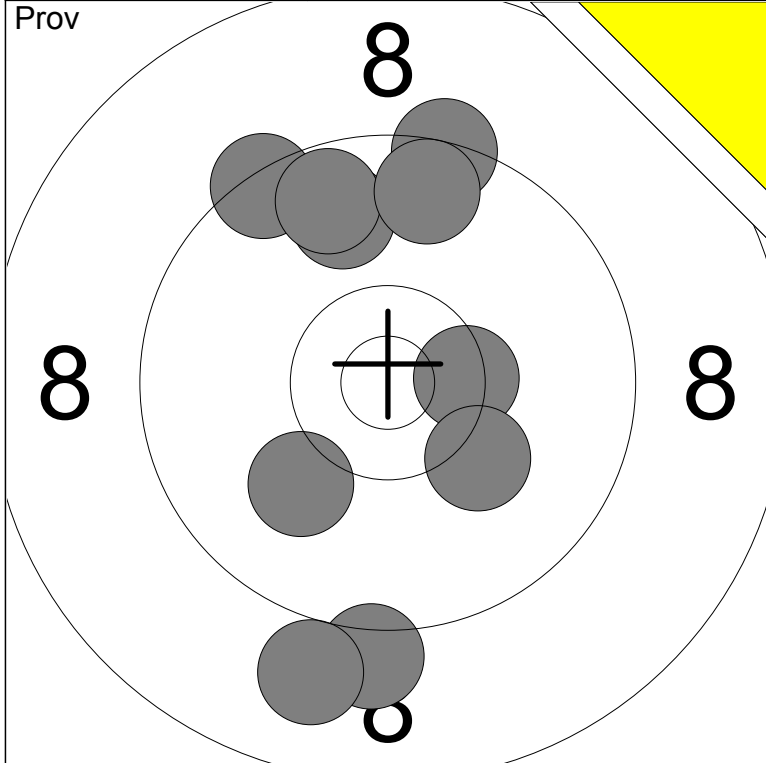

1: 9.8 ↑	6: 9.7 ↑	Serie	93
2: 9.4 ↗	7: 9.7 ↑		
3: 9.4 ↑	8: 10.2 ↘	Total	187
4: 10.1 ↙	9: 9.1 ↓		
5: 10.4x →	10: 9.0 ↓		

1: 9.7 ↘	Serie	45
2: 9.8 ↗		
3: 9.6 ↗	Total	232
4: 8.7 ↑		
5: 10.2 ←		

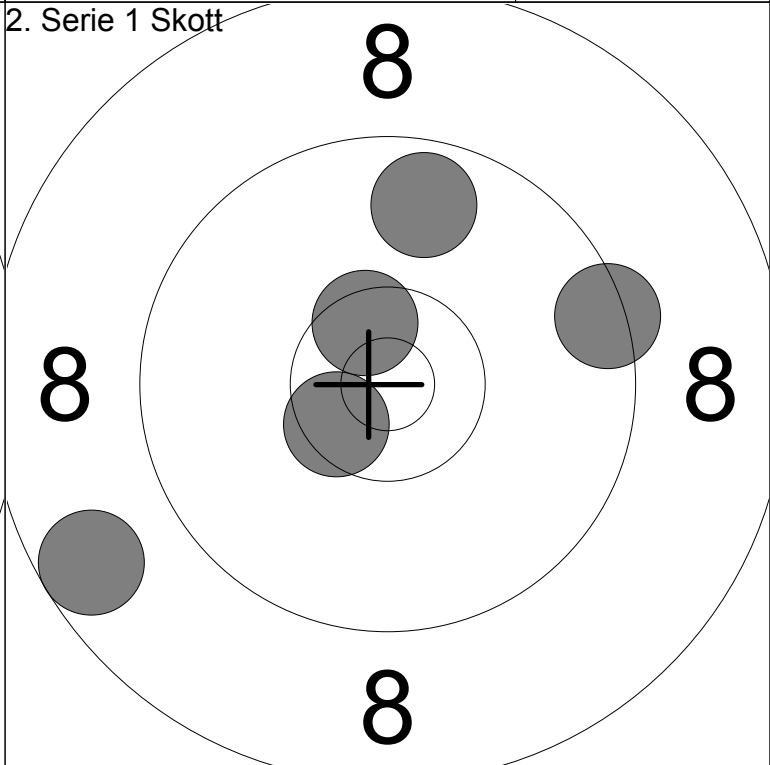
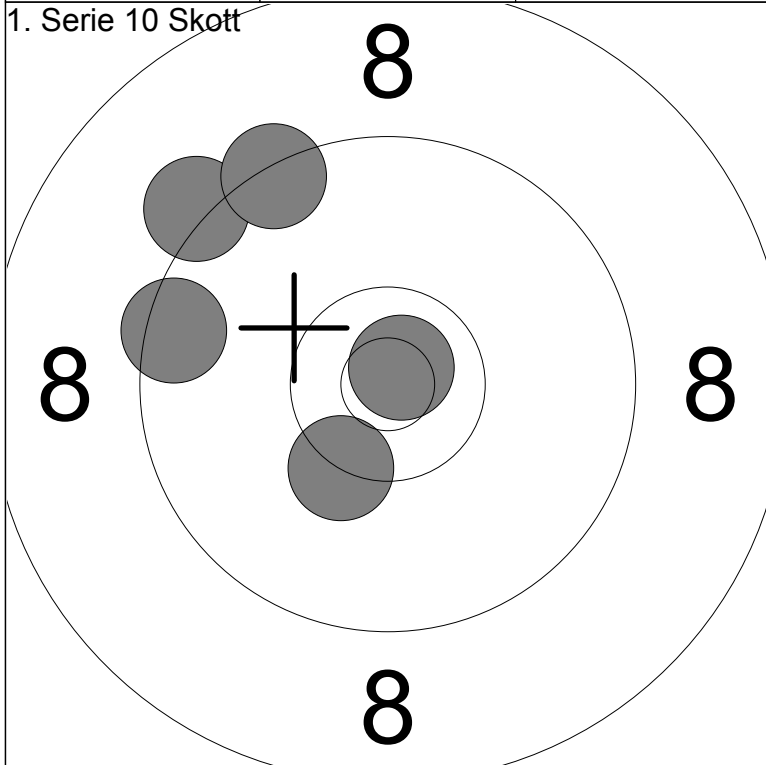

6: 10.8x ↗	Serie	47
7: 9.2 ↘		
8: 9.5 ←	Total	279
9: 10.3x ↘		
10: 9.4 ↑		

1: 9.4 →	Serie	46
2: 10.5x ↙		
3: 10.5x ↑	Total	325
4: 9.7 ↑		
5: 8.7 ↙		

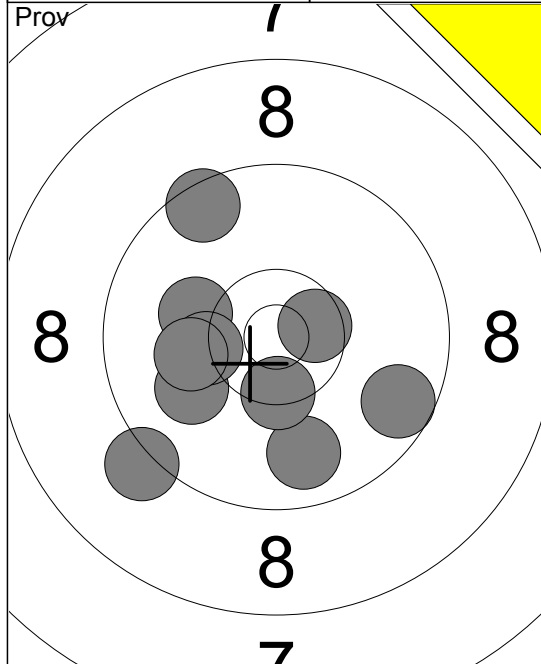

1:	9.8	↓
2:	10.0	↙
3:	10.6	↗
4:	10.1	↙
5:	9.6	↘
6:	9.2	↙
7:	10.3	↙
8:	10.1	↙
9:	9.5	↗
10:	10.4	↘
Serie		96.0
Total		183.0

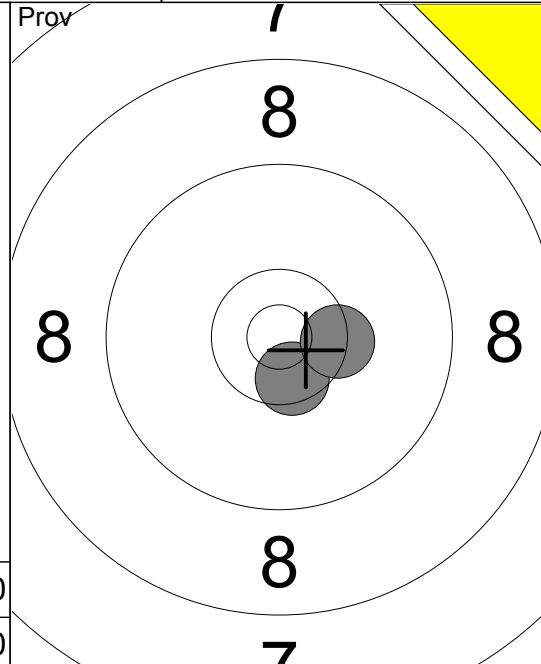

11:	10.5	↘
12:	10.4	↗
Serie		20.0
Total		183.0

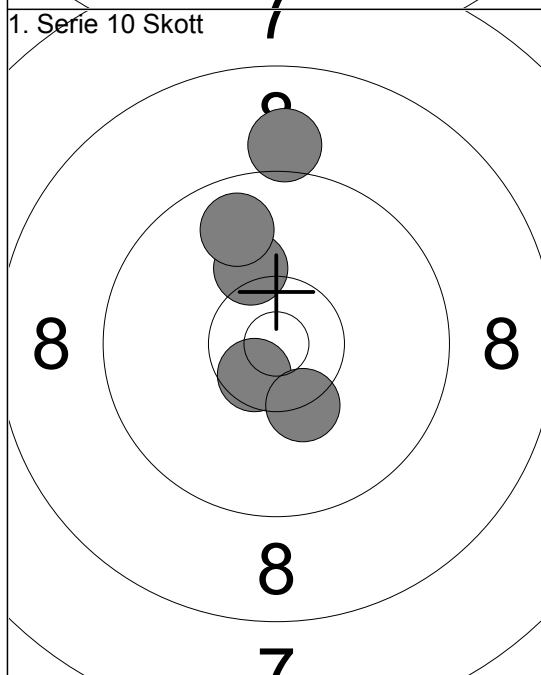

1:	9.1	↑
2:	10.6	↘
3:	10.3	↘
4:	10.2	↑
5:	9.8	↑
Serie		48.0
Total		231.0

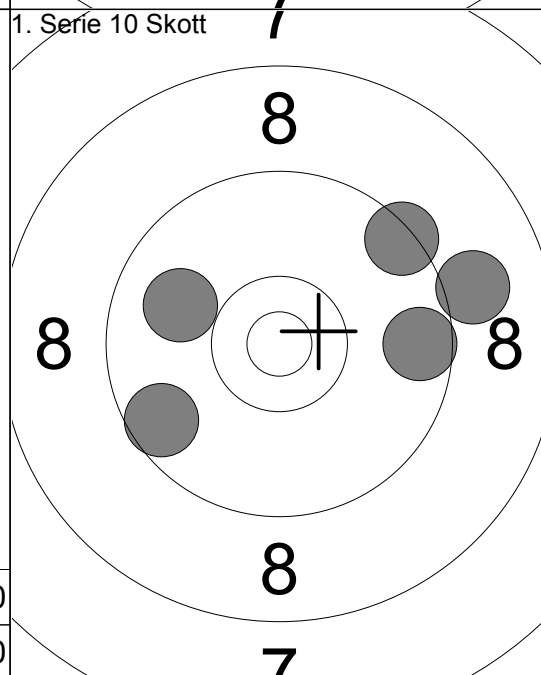

6:	9.0	→
7:	9.9	↙
8:	9.4	↗
9:	9.6	→
10:	9.6	↙
Serie		45.0
Total		276.0

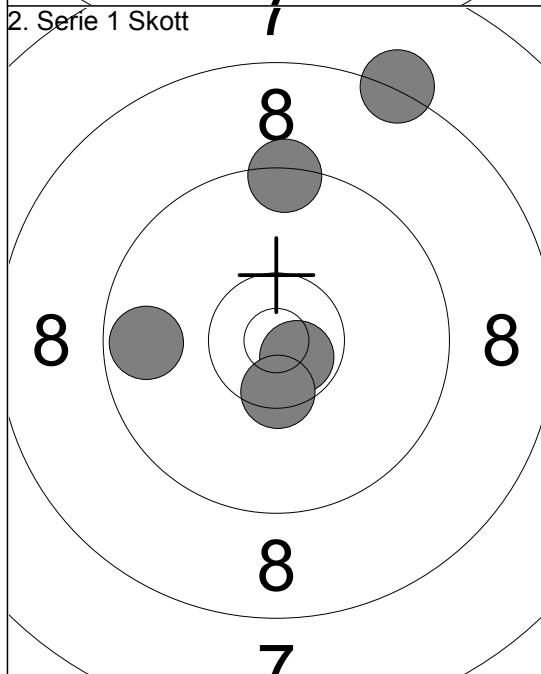

1:	8.3	↗
2:	9.4	↑
3:	10.7	↘
4:	10.5	↘
5:	9.7	←
Serie		46.0
Total		322.0

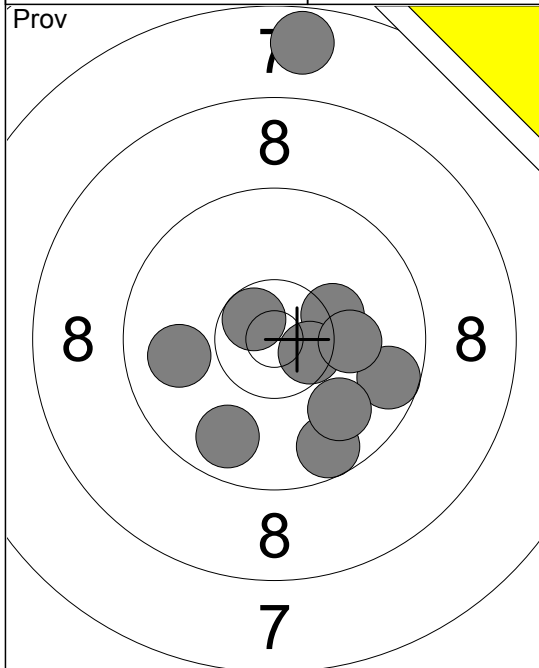

1:	7.7	↑
2:	10.3	→
3:	10.6	↘
4:	10.5	↘
5:	9.6	↓
6:	9.6	→
7:	9.9	↓
8:	9.9	←
9:	9.8	↓
10:	10.1	→
Serie	92.0	
Total	182.0	

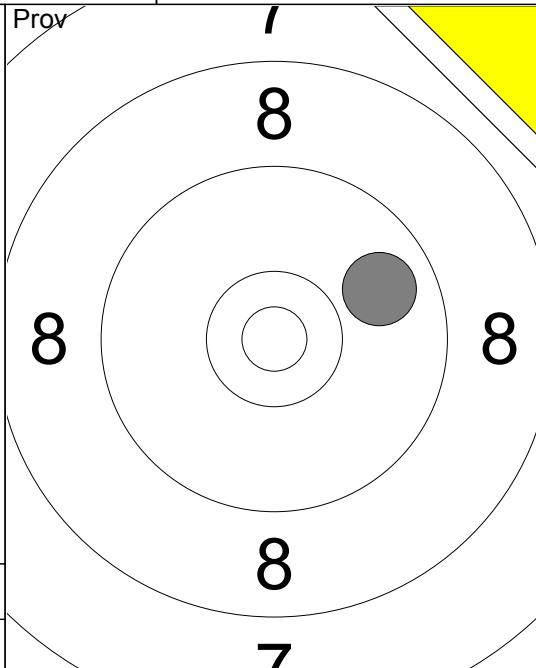

11:	9.8	→
Serie	9.0	
Total	182.0	

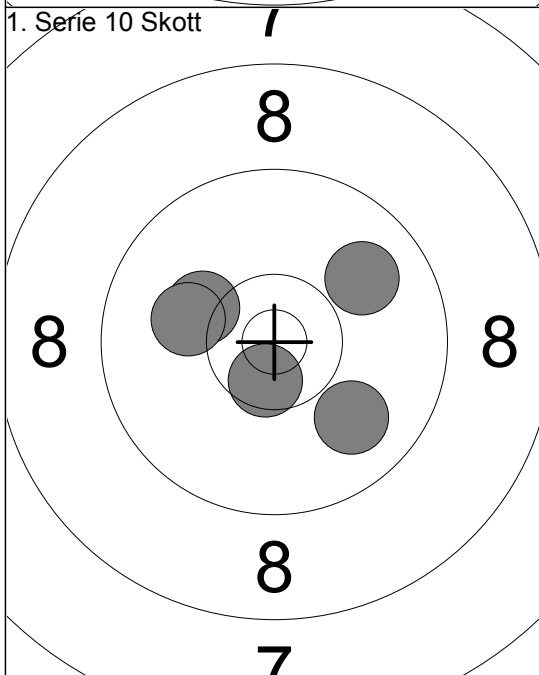

1:	10.2	↖
2:	10.6	↘
3:	9.9	→
4:	9.9	↓
5:	10.1	↖
Serie	48.0	
Total	230.0	

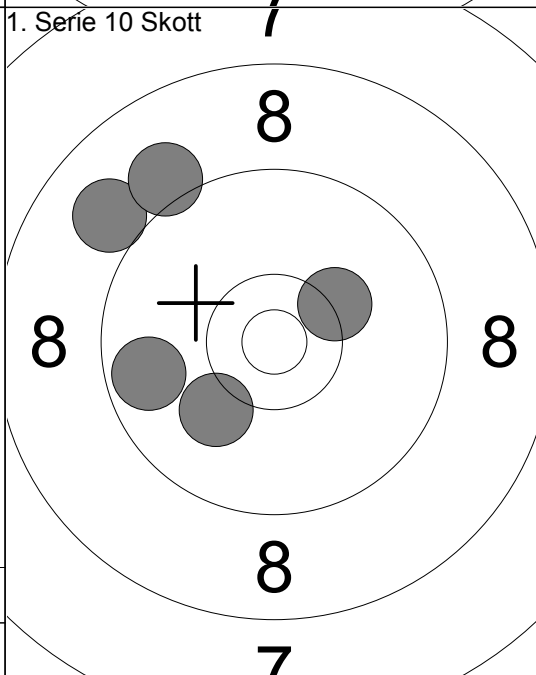

6:	9.0	↖
7:	9.7	←
8:	10.1	↘
9:	10.3	→
10:	9.1	↖
Serie	47.0	
Total	277.0	

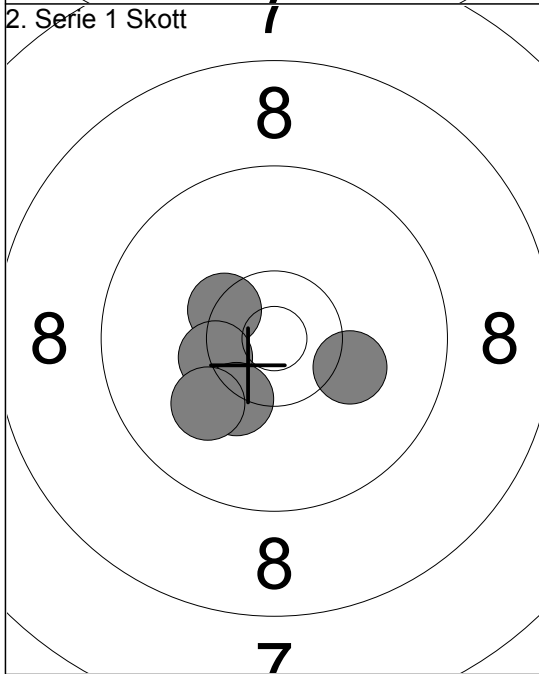

1:	10.4	↘
2:	10.4	↘
3:	10.2	→
4:	10.3	↓
5:	10.1	↘
Serie	50.0	
Total	327.0	

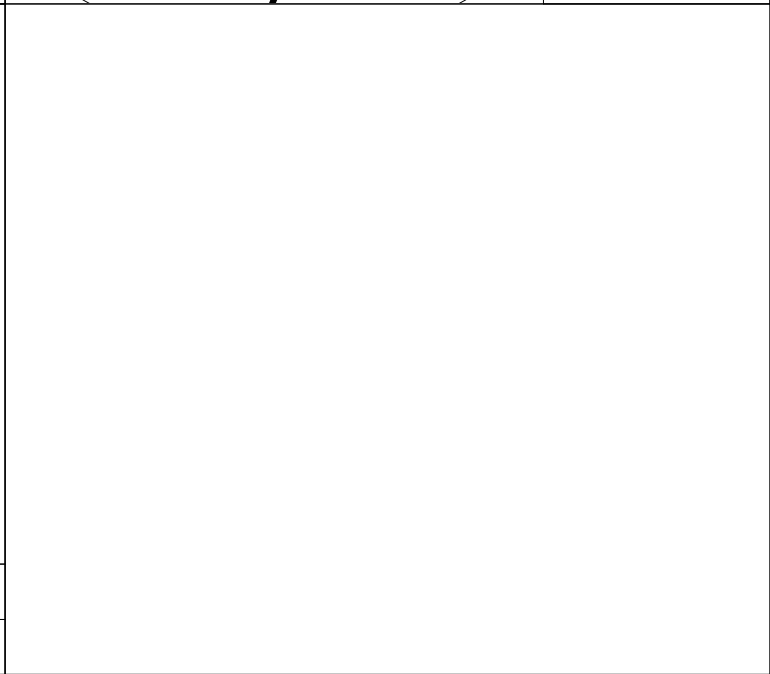

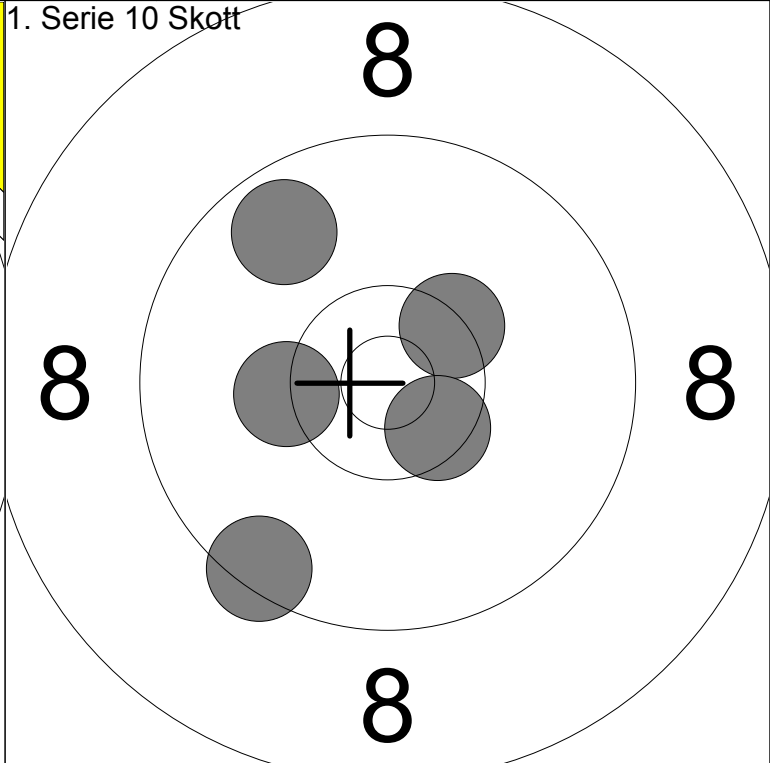
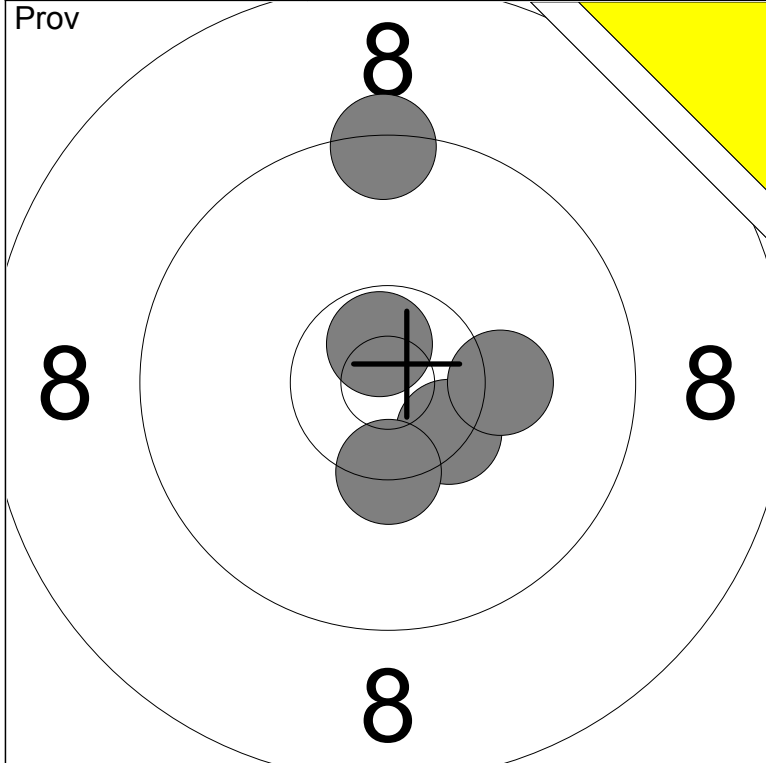

1:	9.4	↑
2:	10.4x	↘
3:	10.4x	↓
4:	10.7x	↑
5:	10.2	→

Serie	49
Total	194

1:	10.3	←
2:	9.4	↘
3:	10.4x	↗
4:	9.7	↖
5:	10.5x	↘

Serie	48
Total	242

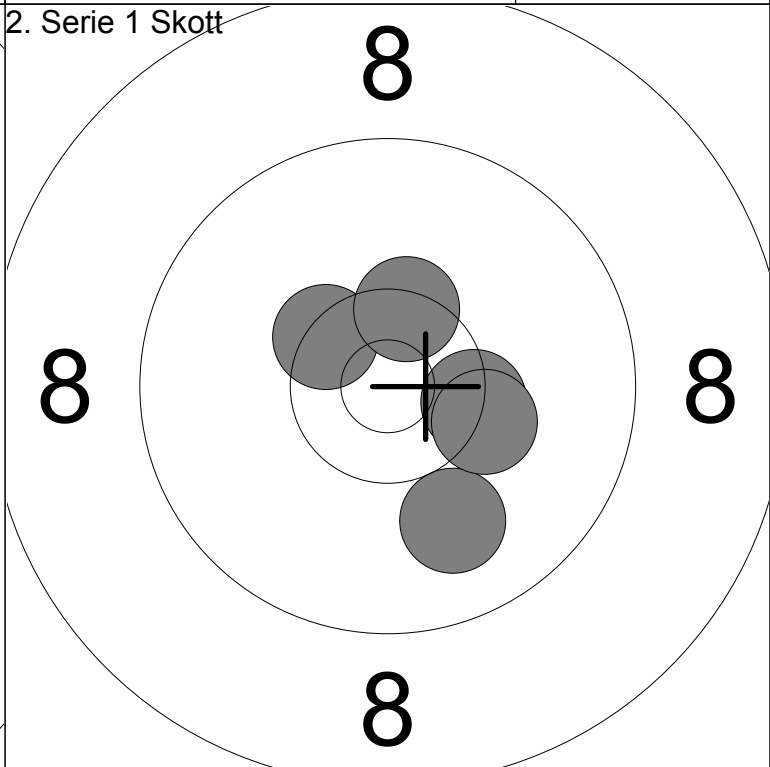
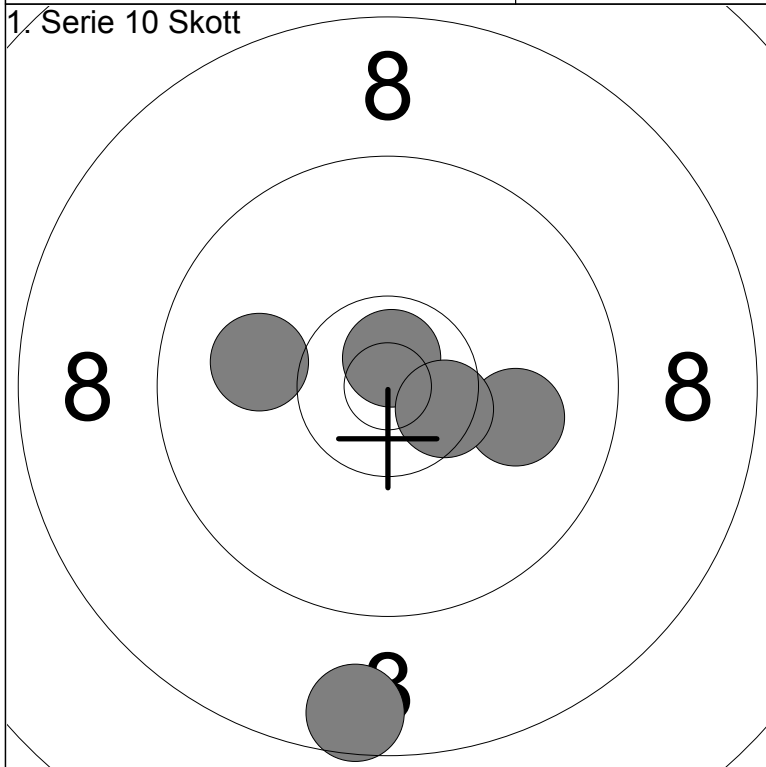

6:	10.0	←
7:	10.7x	↑
8:	8.6	↓
9:	10.0	→
10:	10.5x	↘

Serie	48
Total	290

1:	10.4x	↗
2:	10.0	↘
3:	10.4x	→
4:	10.3	↘
5:	10.4x	↑

Serie	50
Total	340

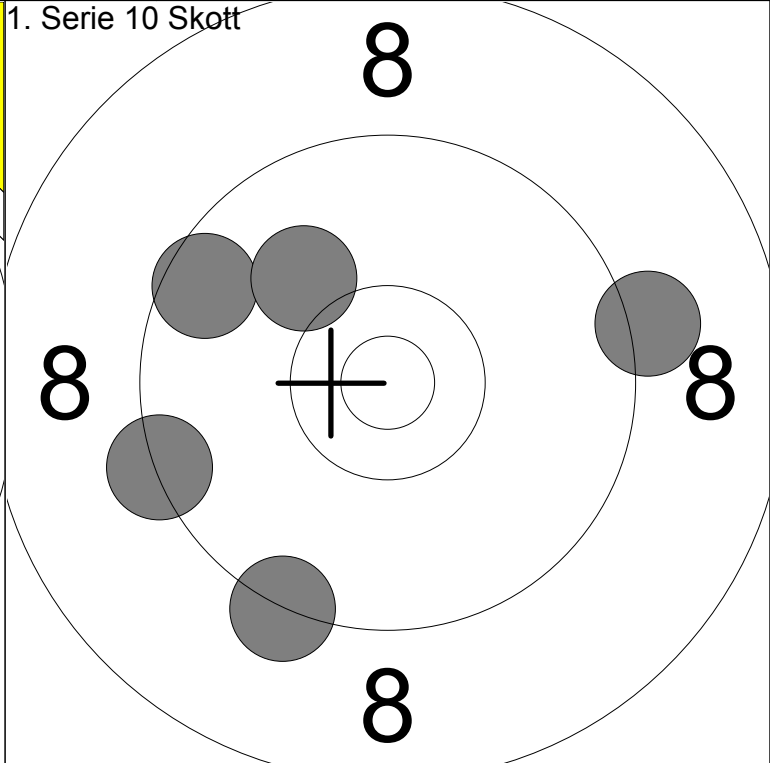
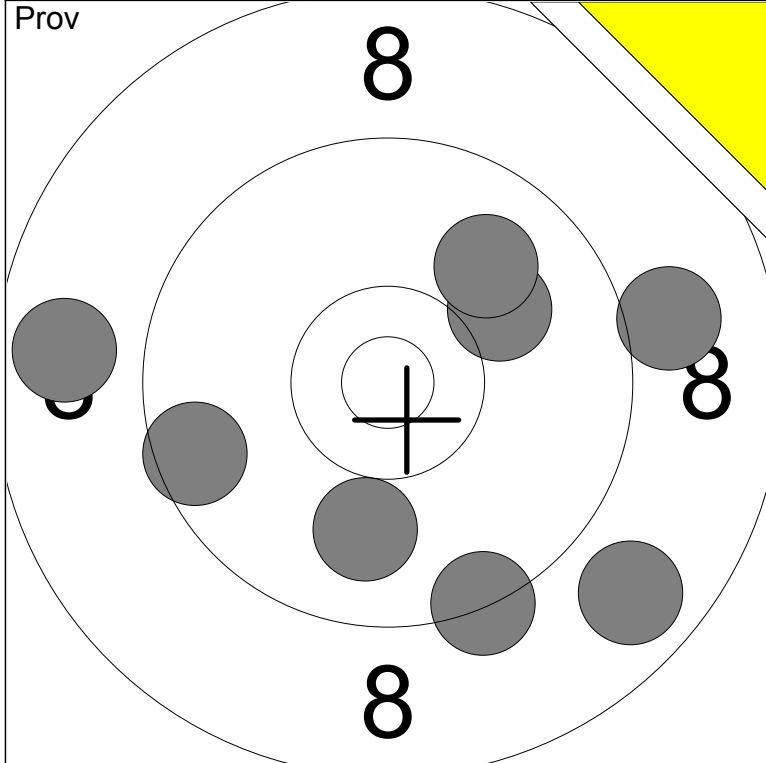

1: 10.0	↓	6: 8.8	←	Serie	72
2: 9.0	→	7: 8.8	↘		
3: 10.1	↗	8: 9.6	←	Total	188
4: 9.9	↗				
5: 9.3	↓				

1: 9.2	→	Serie	46
2: 9.3	←		
3: 9.6	↖	Total	234
4: 10.1	↖		
5: 9.3	↘		

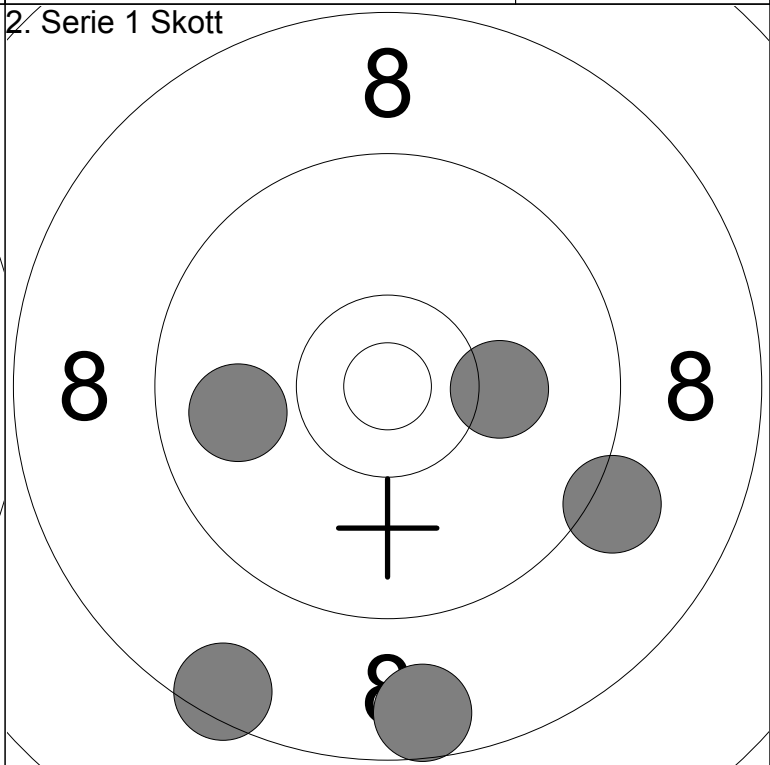
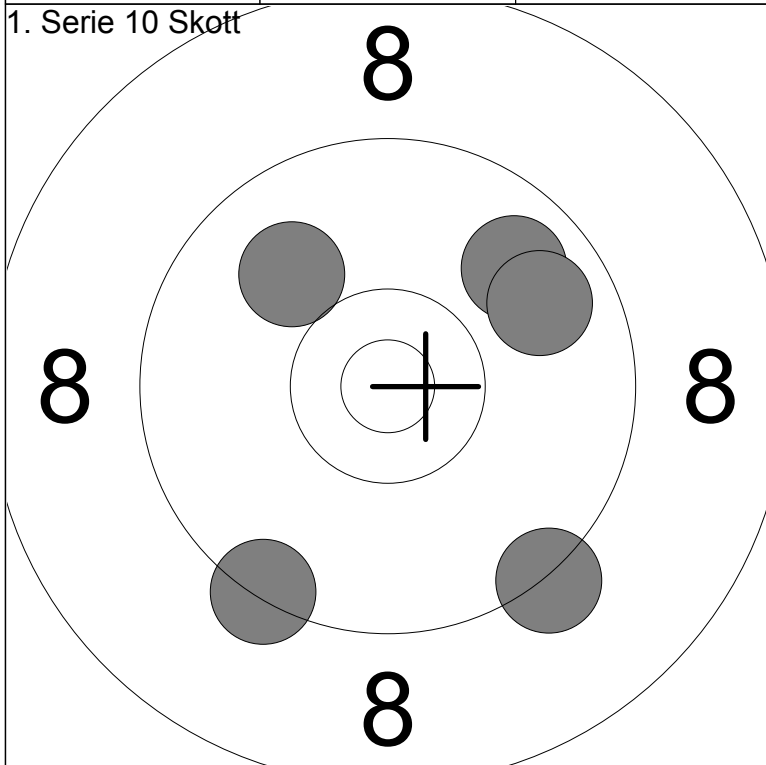

6: 9.8	↗	Serie	46
7: 9.8	↗		
8: 10.0	↗	Total	280
9: 9.3	↘		
10: 9.3	↘		

1: 8.6	↓	Serie	44
2: 8.5	↘		
3: 9.9	←	Total	324
4: 10.2	→		
5: 9.2	↘		

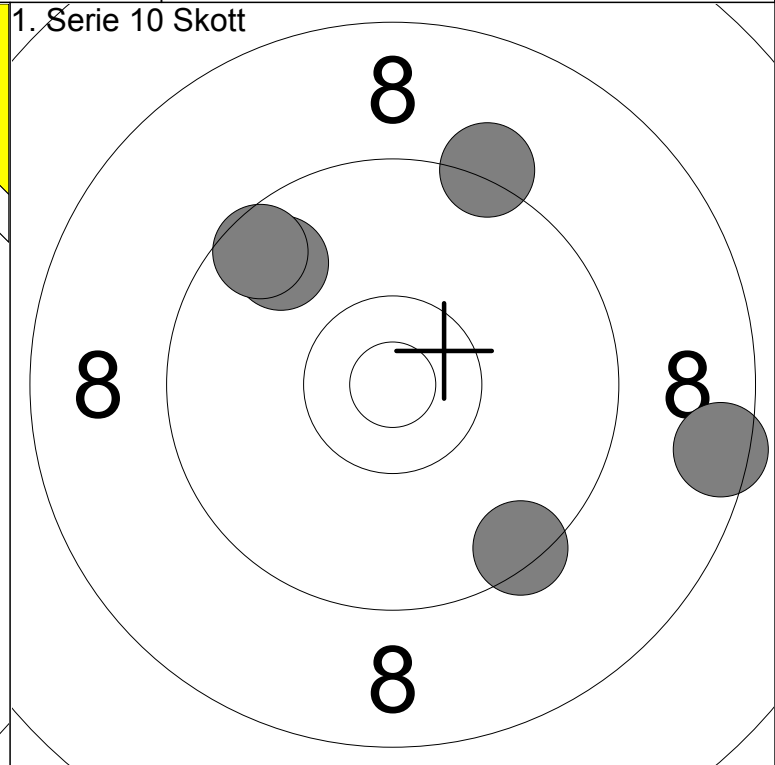
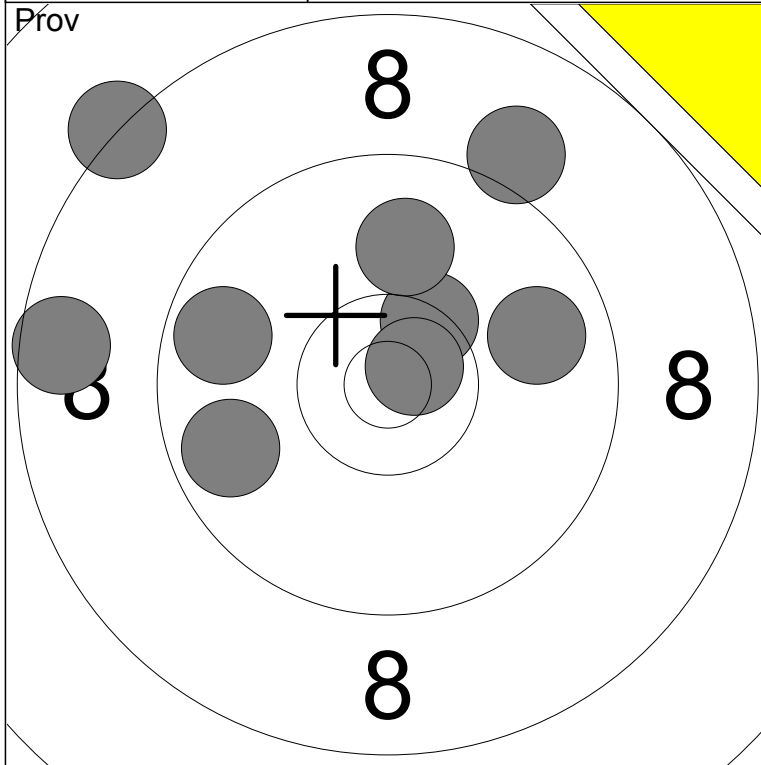

1: 8.6 ←	6: 10.0 ↑	Serie	82
2: 9.1 ↗	7: 9.7 ←		
3: 8.3 ↖	8: 9.7 ←	Total	188
4: 9.8 →	9: 10.7x ↗		
5: 10.4x ↗			

1: 9.7 ↗	Serie	44
2: 9.2 ↗		
3: 8.5 →	Total	232
4: 9.6 ↗		
5: 9.4 ↓		

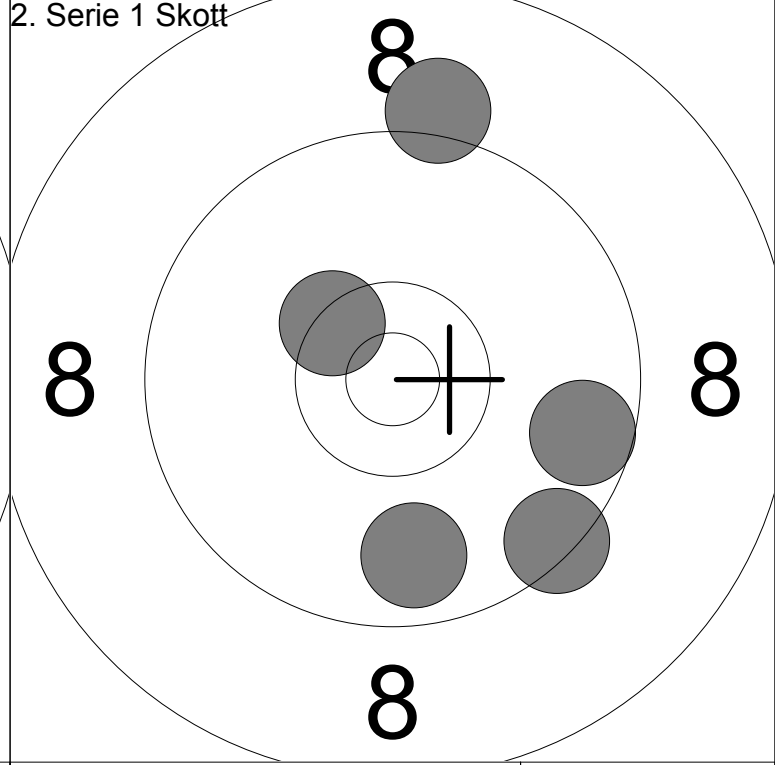
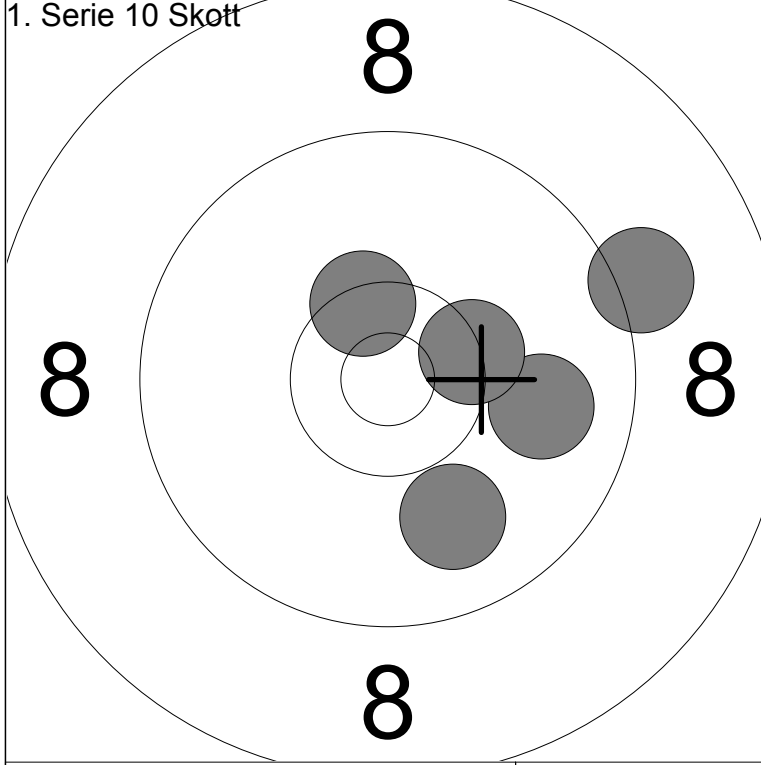

6: 9.9 ↓	Serie	47
7: 9.9 →		
8: 9.1 →	Total	279
9: 10.4x →		
10: 10.4x ↗		

1: 9.8 ↓	Serie	46
2: 10.4x ↗		
3: 9.6 →	Total	325
4: 9.4 ↓		
5: 9.1 ↑		

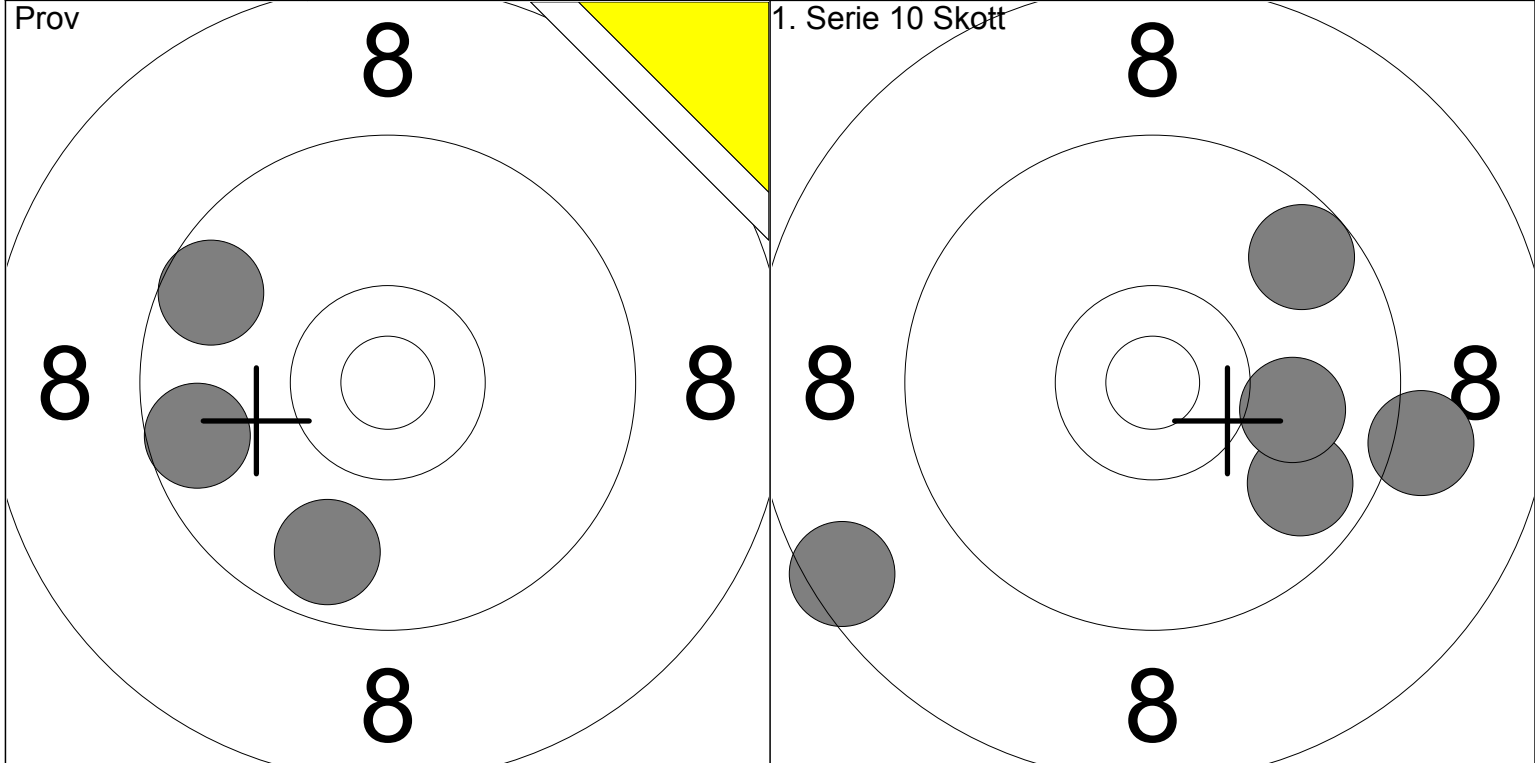

1: 9.6 ←	Serie 27	1: 9.8 ↘	Serie 45
2: 9.6 ↖		2: 8.5 ↙	
3: 9.8 ↙		3: 9.7 ↗	
Total 180	4: 9.1 →	Total 225	
	5: 10.0 →		

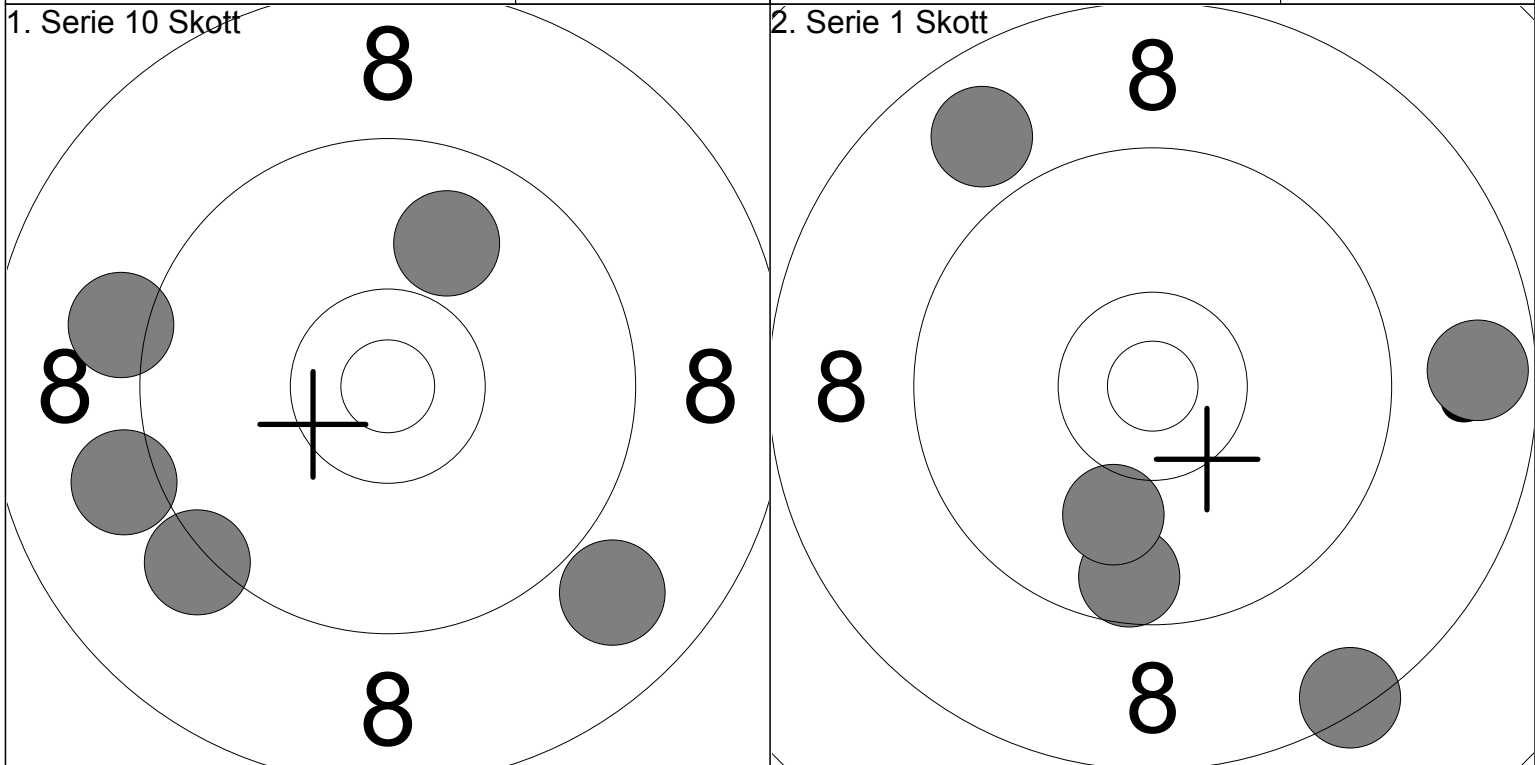

6: 9.9 ↗	Serie 44	1: 8.4 ↙	Serie 43
7: 8.9 ↘		2: 8.9 ↗	
8: 9.1 ↙		3: 9.6 ↙	
9: 9.2 ↙	Total 269	4: 10.0 ↙	Total 312
10: 9.1 ↙		5: 8.7 →	

50m

24.04.2016

Vindelnskottet 2016

Ramselefors SKF

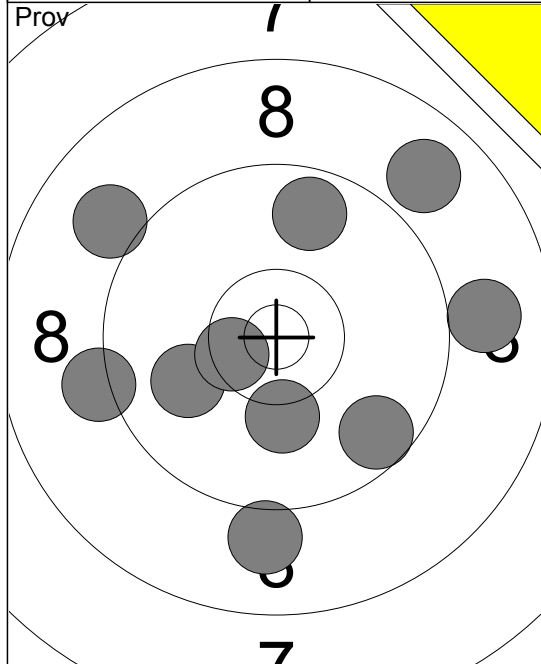

- 1: 9.0 ↓
- 2: 10.2 ↓
- 3: 8.9 ↗
- 4: 9.6 ↘
- 5: 9.2 ←
- 6: 9.0 ↖
- 7: 10.0 ↙
- 8: 9.0 →
- 9: 10.5 ✗
- 10: 9.7 ↑

Serie 92.0
Total 0.0

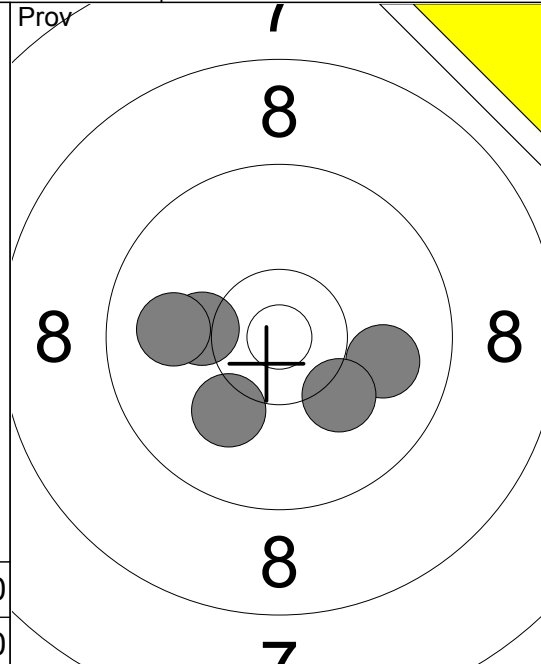

- 11: 9.9 →
- 12: 10.2 ←
- 13: 10.2 ↘
- 14: 10.1 ↙
- 15: 9.9 ←

Serie 48.0
Total 0.0

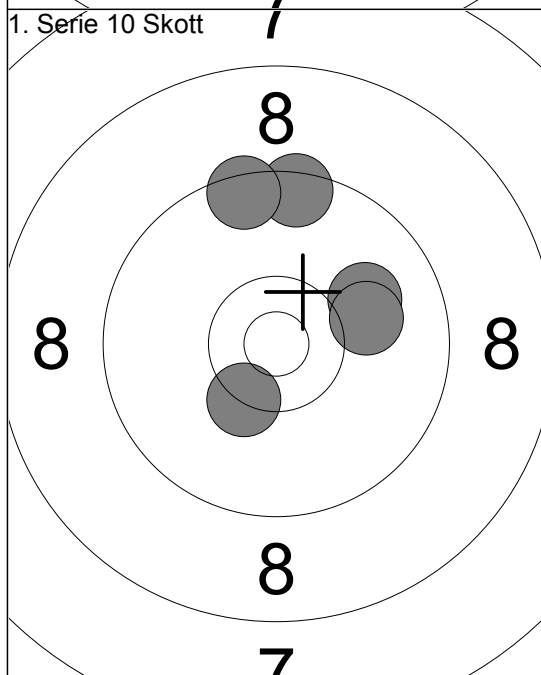

1. Serie 10 Skott

- 1: 10.0 →
- 2: 10.1 →
- 3: 9.5 ↑
- 4: 9.5 ↑
- 5: 10.3 ✗

Serie 48.0
Total 48.0

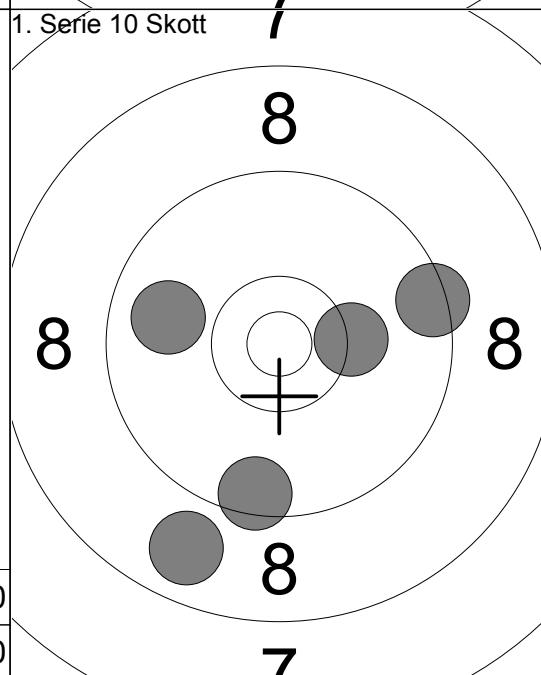

1. Serie 10 Skott

- 6: 9.4 →
- 7: 9.5 ↓
- 8: 9.9 ←
- 9: 10.3 →
- 10: 8.8 ↓

Serie 45.0
Total 93.0

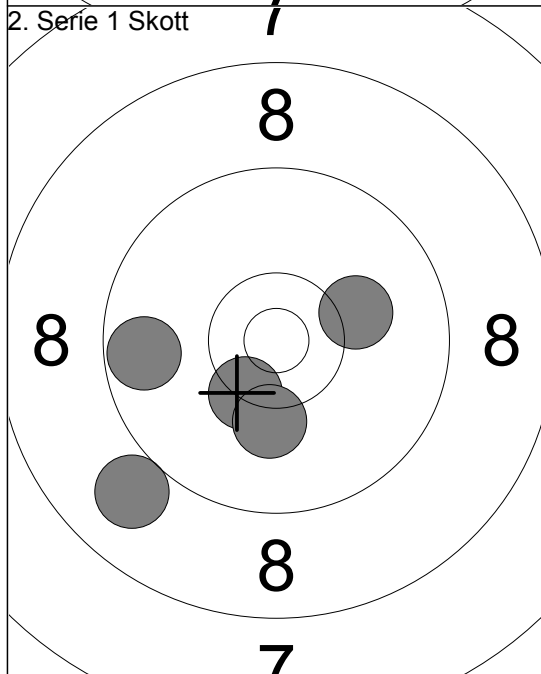

2. Serie 1 Skott

- 1: 9.0 ↘
- 2: 10.4 ✗
- 3: 9.7 ←
- 4: 10.2 ↓
- 5: 10.1 →

Serie 48.0
Total 141.0

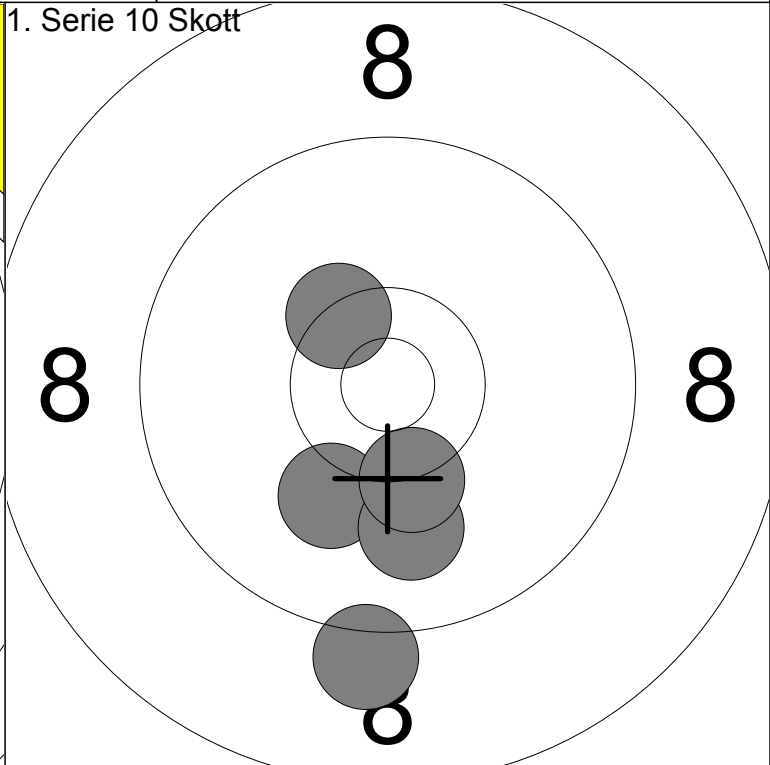
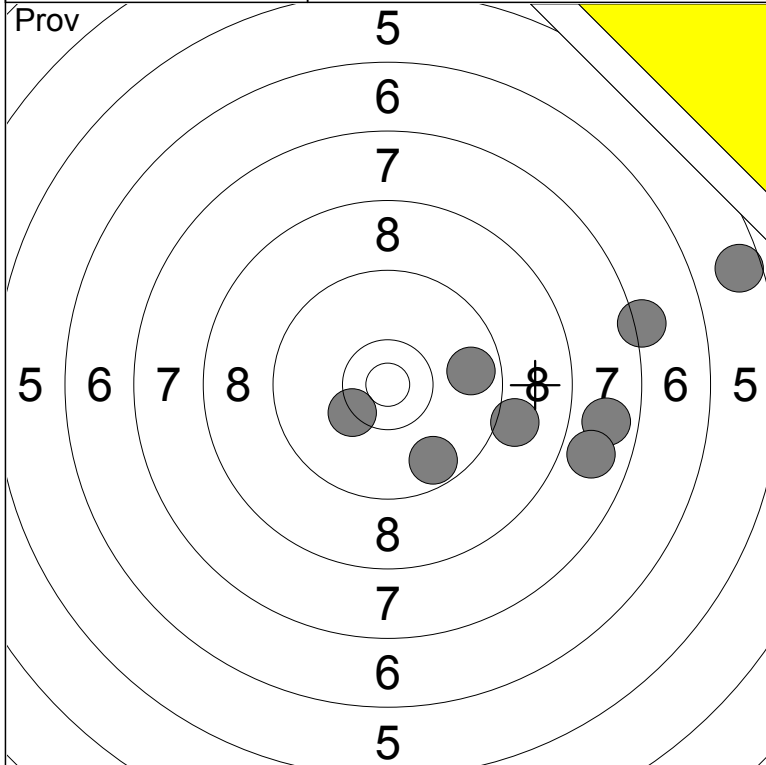

1: 5.6 →	6: 7.9 →	Serie	63
2: 7.2 →	7: 9.7 →		
3: 9.7 ↙	8: 10.3x ↙	Total	178
4: 9.0 →			
5: 7.8 →			

1: 10.1 ↘	Serie	49
2: 9.1 ↓		
3: 10.0 ↓	Total	227
4: 10.4x ↗		
5: 10.3x ↓		

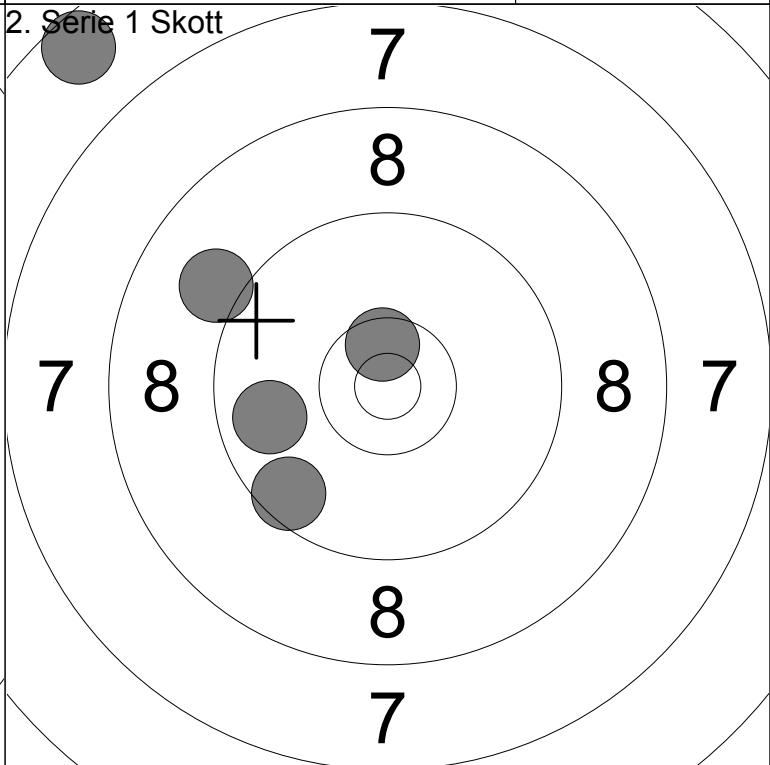
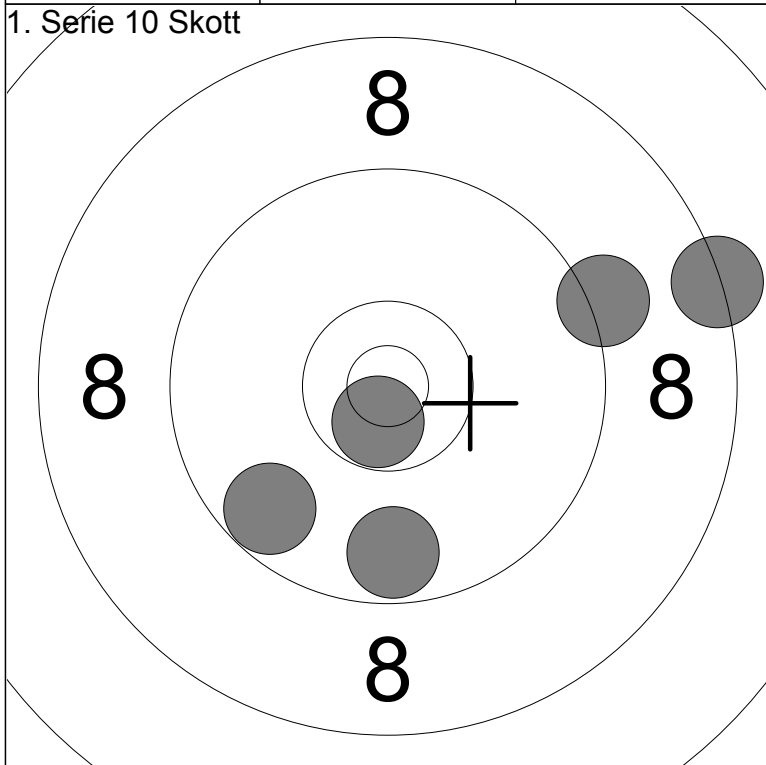

6: 9.2 ↗	Serie	45
7: 10.7x ↓		
8: 8.3 →	Total	272
9: 9.7 ↘		
10: 9.7 ↓		

1: 9.6 ↘	Serie	43
2: 9.1 ↖		
3: 6.6 ↗	Total	315
4: 10.6x ↑		
5: 9.8 ←		

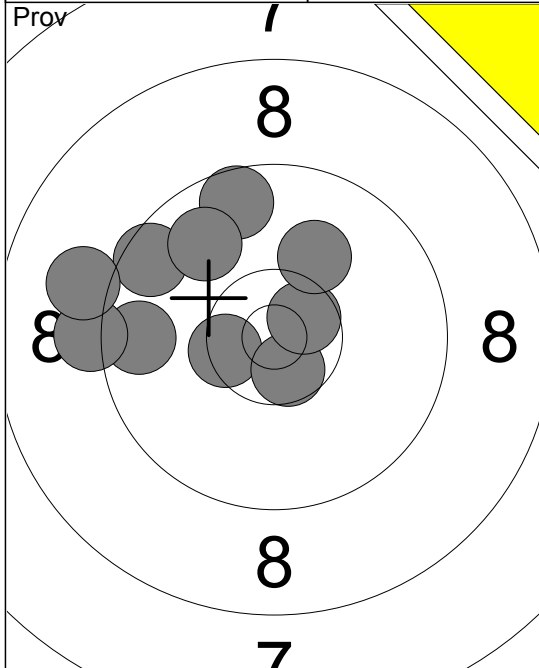

- 1: 9.7 ←
- 2: 10.5x ↘
- 3: 9.2 ←
- 4: 9.6 ↖
- 5: 9.1 ←
- 6: 10.6x ↘
- 7: 10.6x ↗
- 8: 10.1 ↗
- 9: 9.6 ↑
- 10: 9.8 ↖

Serie 94.0
Total 177.0

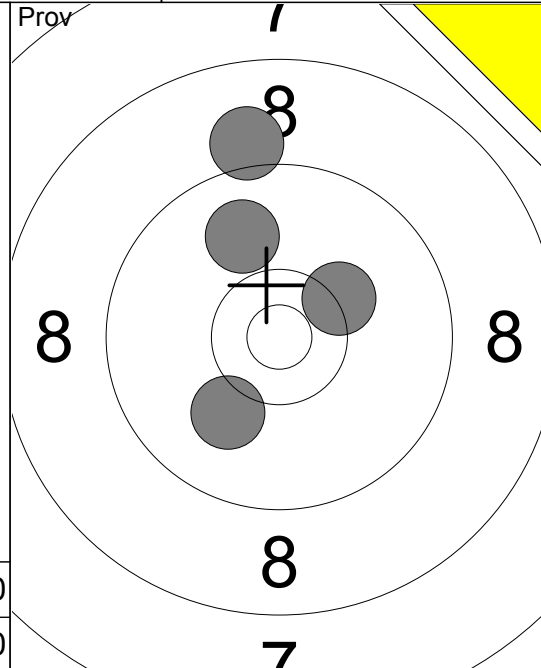

- 11: 9.9 ↗
- 12: 10.3 ↗
- 13: 9.1 ↑
- 14: 10.1 ↘

Serie 38.0
Total 177.0

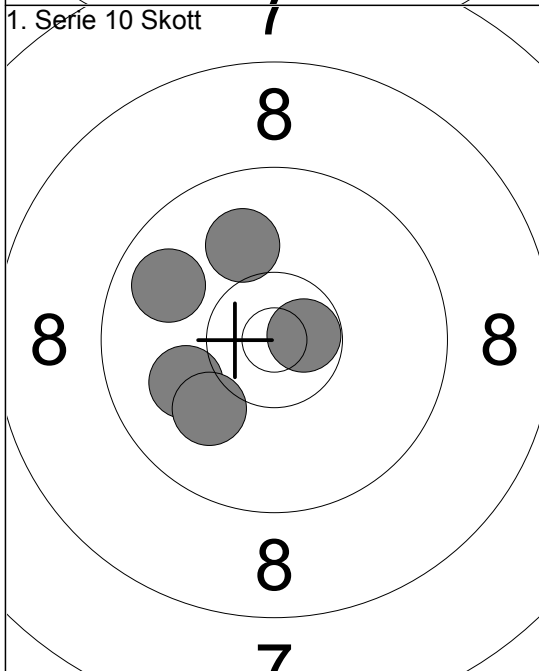

- 1: 10.0 ↗
- 2: 10.0 ↖
- 3: 10.7x ↗
- 4: 9.8 ↖
- 5: 10.0 ↘

Serie 49.0
Total 226.0

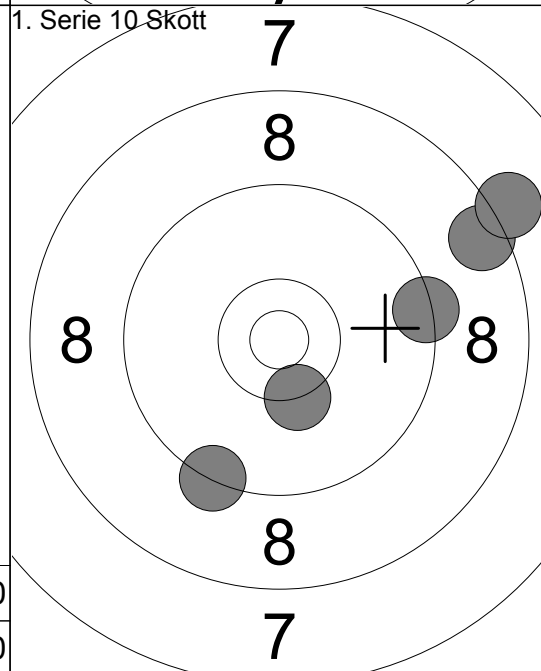

- 6: 10.3x ↘
- 7: 9.4 →
- 8: 9.3 ↘
- 9: 8.5 ↗
- 10: 8.1 ↗

Serie 44.0
Total 270.0

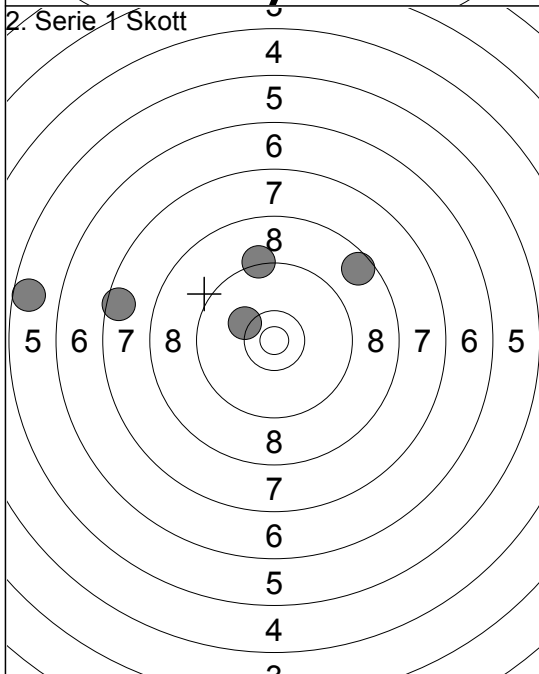

- 1: 8.6 ↗
- 2: 7.5 ←
- 3: 9.2 ↑
- 4: 10.2 ↖
- 5: 5.6 ←

Serie 39.0
Total 309.0

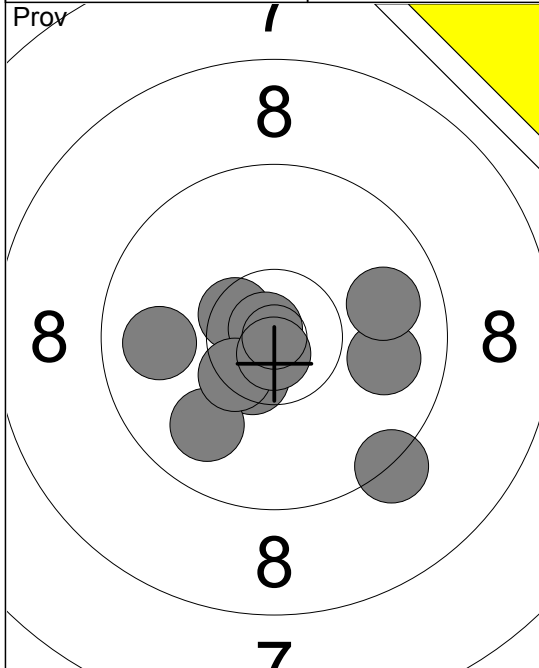

1:	9.3	↘
2:	9.9	→
3:	9.9	→
4:	10.5	↘
5:	9.9	←
6:	10.5	↘
7:	9.9	↘
8:	10.8	↘
9:	10.4	↘
10:	10.8	↘
Serie	95.0	
Total	175.0	

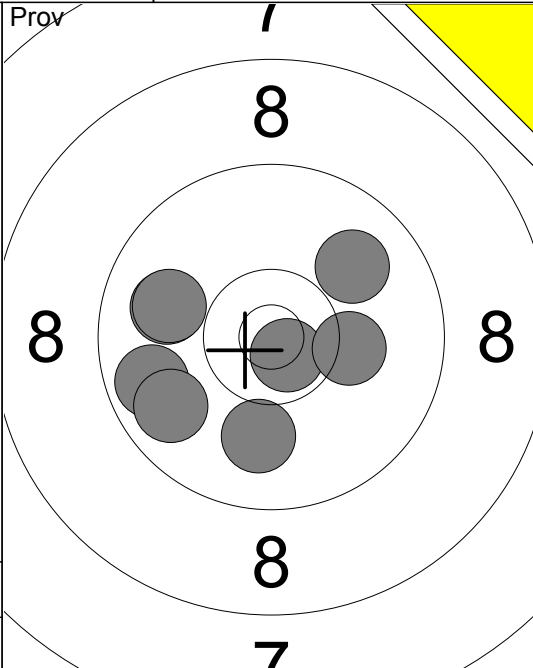

11:	9.9	←
12:	10.7	↘
13:	9.9	↗
14:	10.2	→
15:	9.7	←
16:	9.9	←
17:	10.0	↓
18:	9.8	↙
Serie	75.0	
Total	175.0	

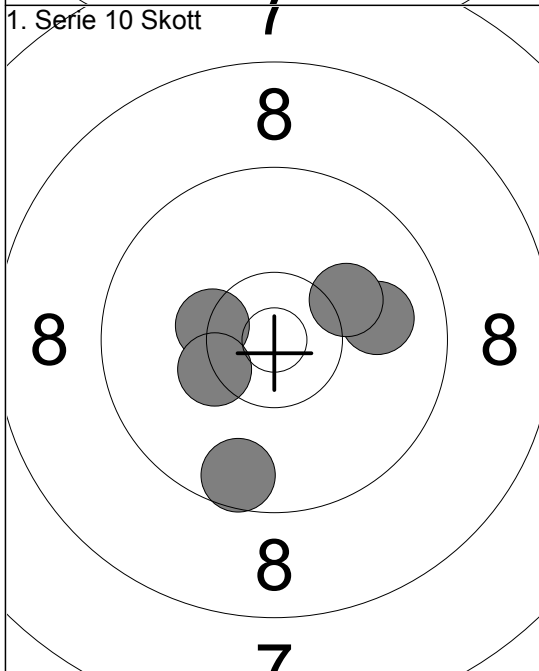

1:	10.3	↘
2:	10.3	↘
3:	9.9	→
4:	9.6	↓
5:	10.2	↗
Serie	48.0	
Total	223.0	

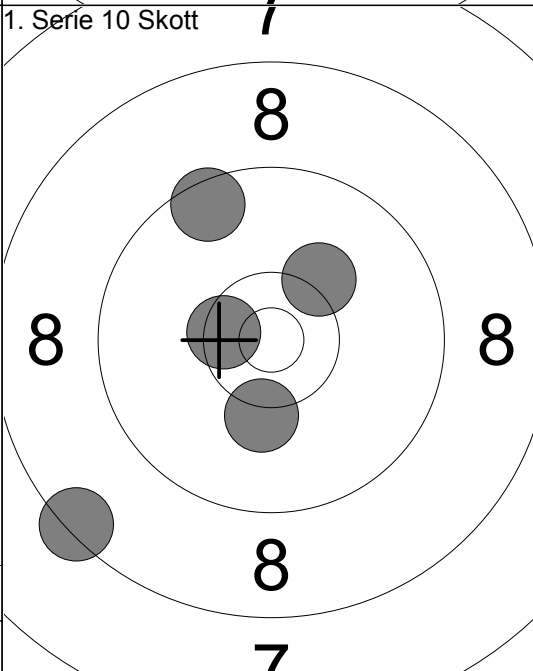

6:	10.5	↘
7:	10.2	↗
8:	8.4	↙
9:	9.5	↖
10:	10.2	↓
Serie	47.0	
Total	270.0	

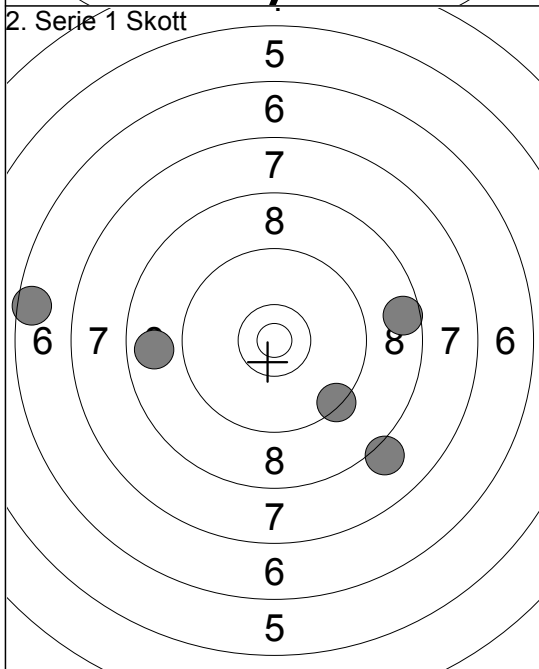

1:	9.4	↘
2:	8.6	→
3:	8.1	↘
4:	6.6	←
5:	8.8	←
Serie	39.0	
Total	309.0	

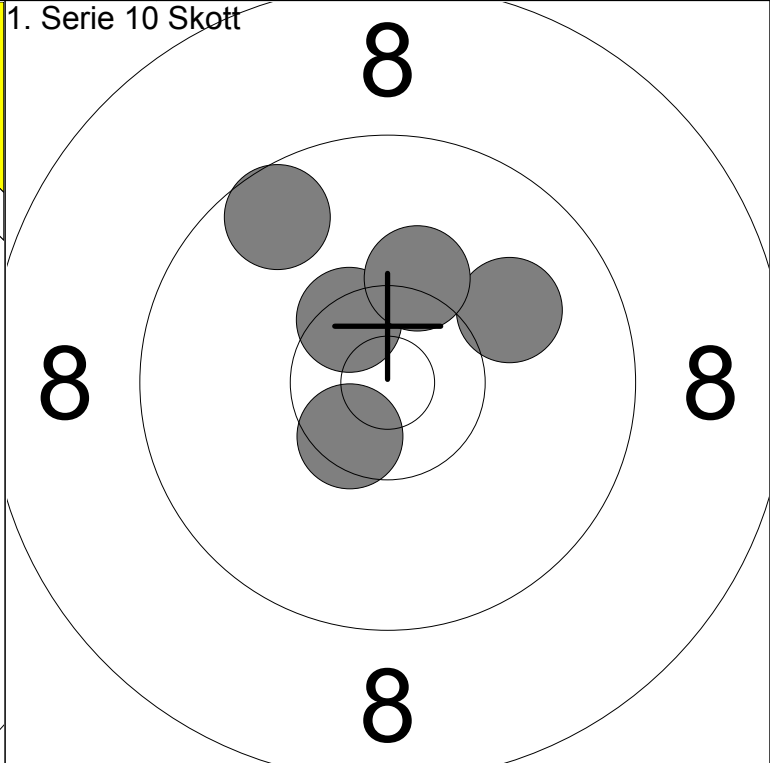
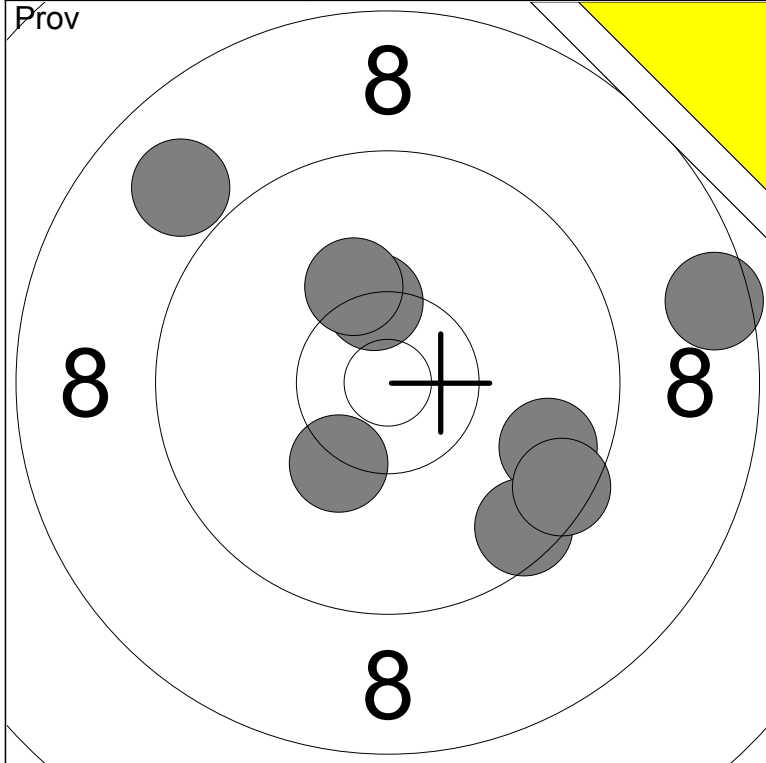

1: 8.6 →	6: 9.5 ↘	Serie	73
2: 10.3 ↘	7: 9.5 ↘		
3: 10.4x ↑	8: 10.2 ↗	Total	170
4: 8.9 ↗			
5: 9.7 ↘			

1: 10.5x ↖	Serie	49
2: 10.0 ↗		
3: 10.5x ↘	Total	219
4: 9.6 ↖		
5: 10.2 ↑		

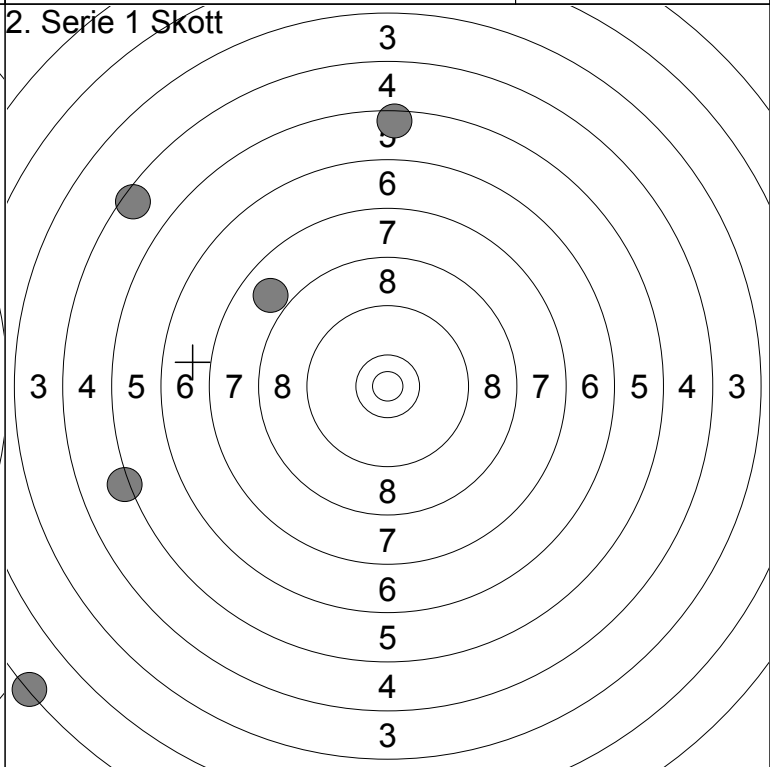
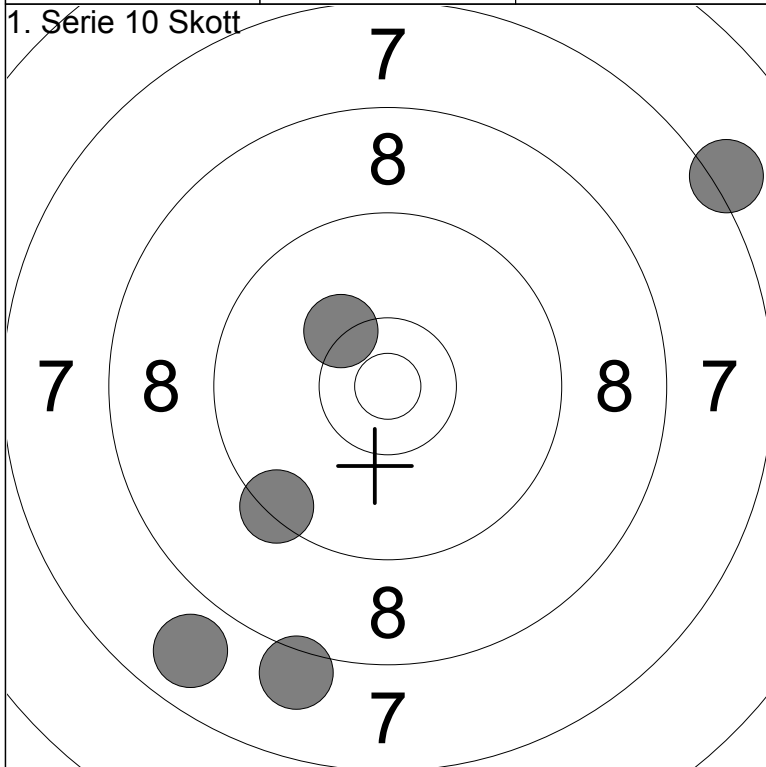

6: 7.2 ↗	Serie	41
7: 8.1 ↘		
8: 10.3 ↖	Total	260
9: 7.8 ↘		
10: 9.4 ↘		

1: 4.5 ↖	Serie	22
2: 1.3 ↘		
3: 5.2 ↖	Total	282
4: 5.5 ↑		
5: 7.9 ↖		

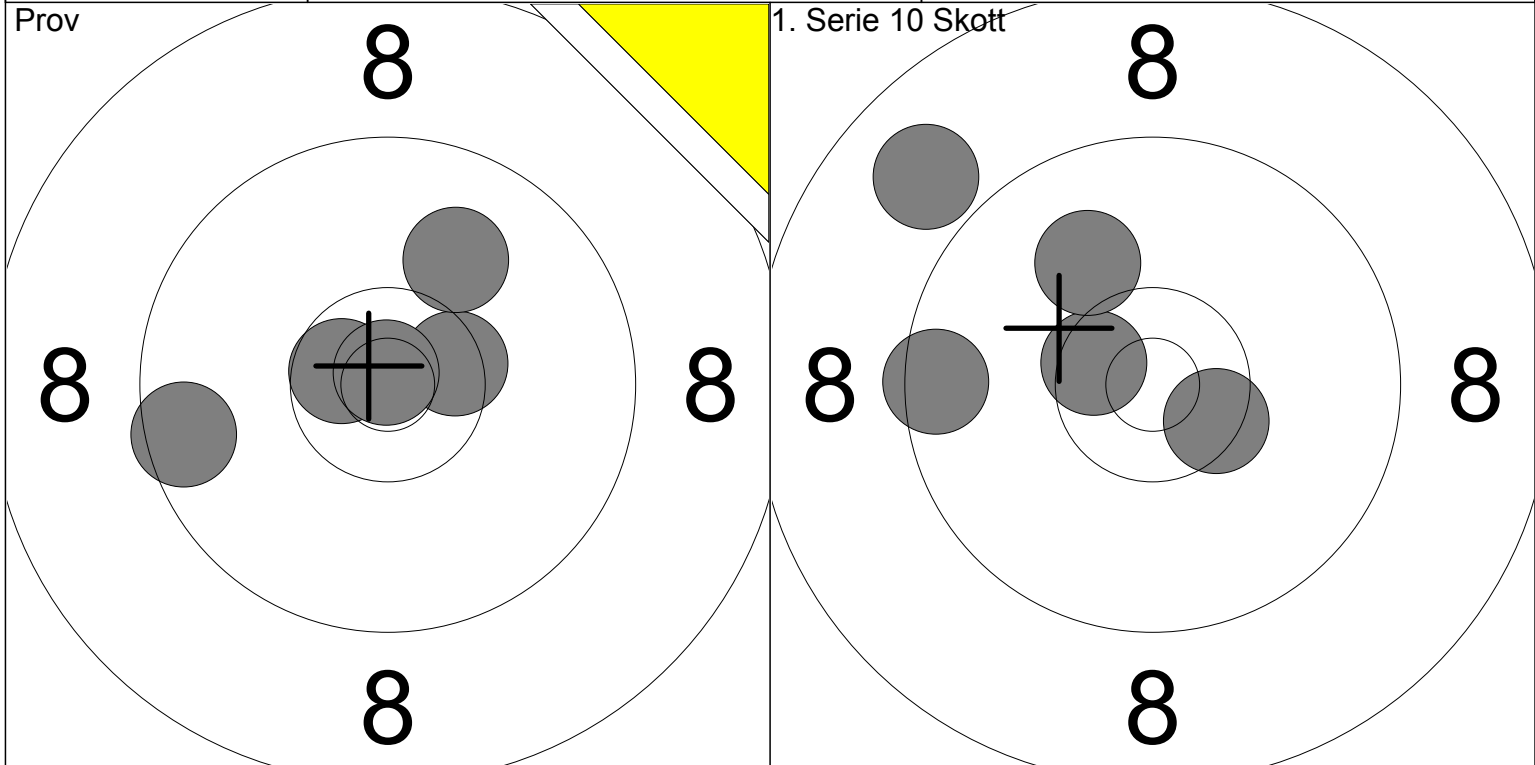

1: 10.5x → 2: 10.0 ↗ 3: 10.6x ← 4: 9.6 ← 5: 10.9x ↑	Serie 49 <hr/> Total 163	1: 9.5 ← 2: 8.9 ↗ 3: 10.5x ← 4: 10.0 ↗ 5: 10.5x ↘	Serie 47 <hr/> Total 210
---	-----------------------------	---	-----------------------------

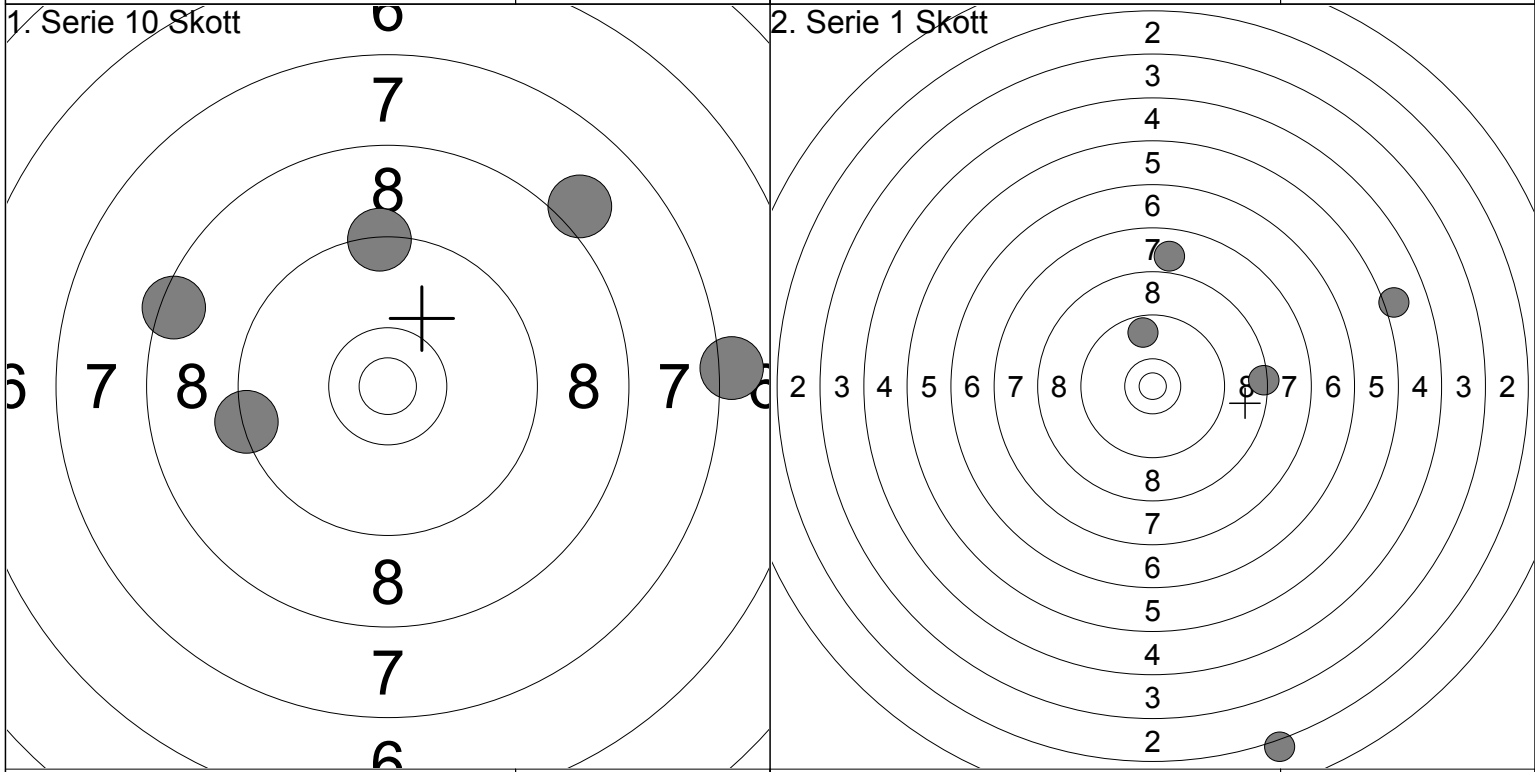

6: 8.1 ↗ 7: 9.3 ↑ 8: 7.2 → 9: 9.3 ← 10: 8.4 ←	Serie 41 <hr/> Total 251	1: 7.9 ↑ 2: 2.2 ↓ 3: 9.7 ↑ 4: 8.4 → 5: 5.1 →	Serie 31 <hr/> Total 282
---	-----------------------------	--	-----------------------------

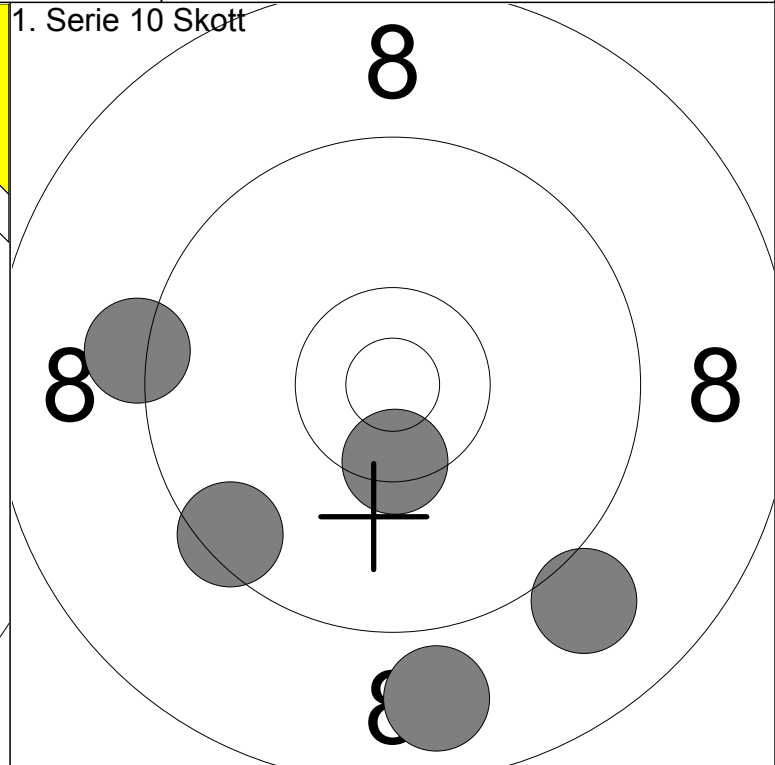
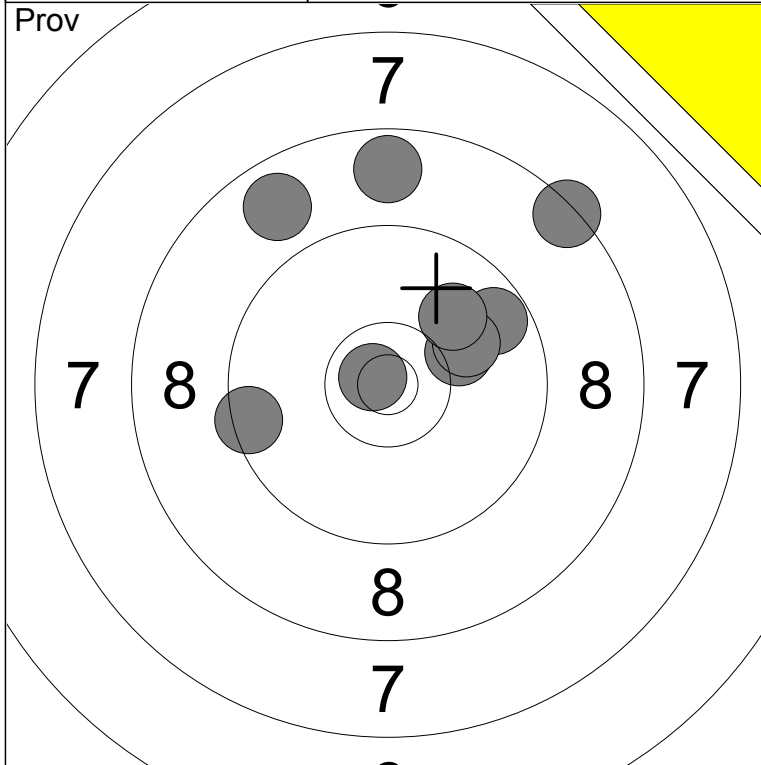

1: 9.7 ↗	6: 8.8 ↖	Serie	88
2: 6.5 ↗	7: 9.5 ←		
3: 10.1 ↗	8: 10.0 ↗	Total	176
4: 8.7 ↑	9: 10.8x ↖		
5: 8.4 ↗	10: 10.0 ↗		

1: 9.5 ↙	Serie	45
2: 9.2 ←		
3: 10.4x ↓	Total	221
4: 9.0 ↘		
5: 8.8 ↓		

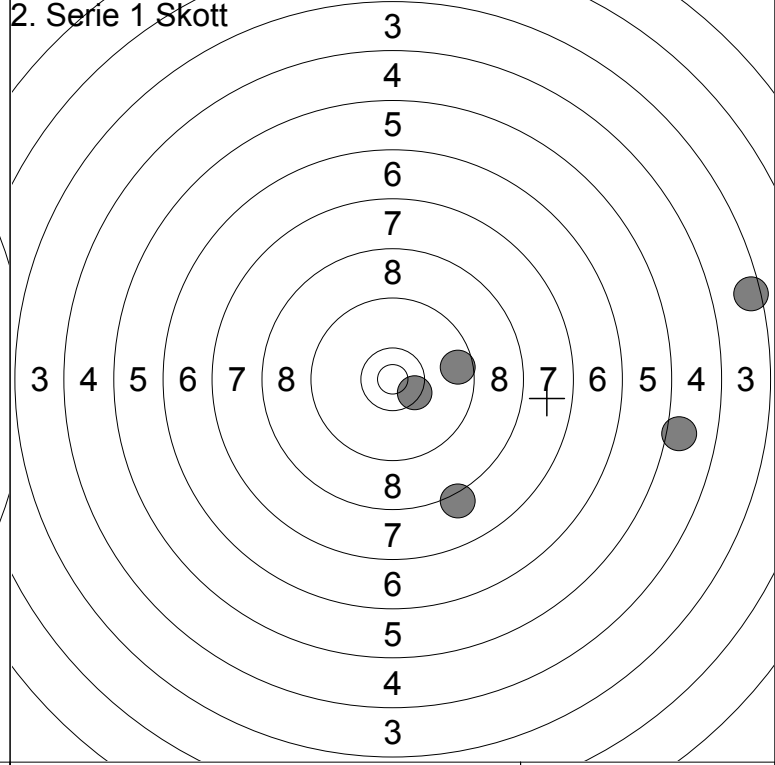
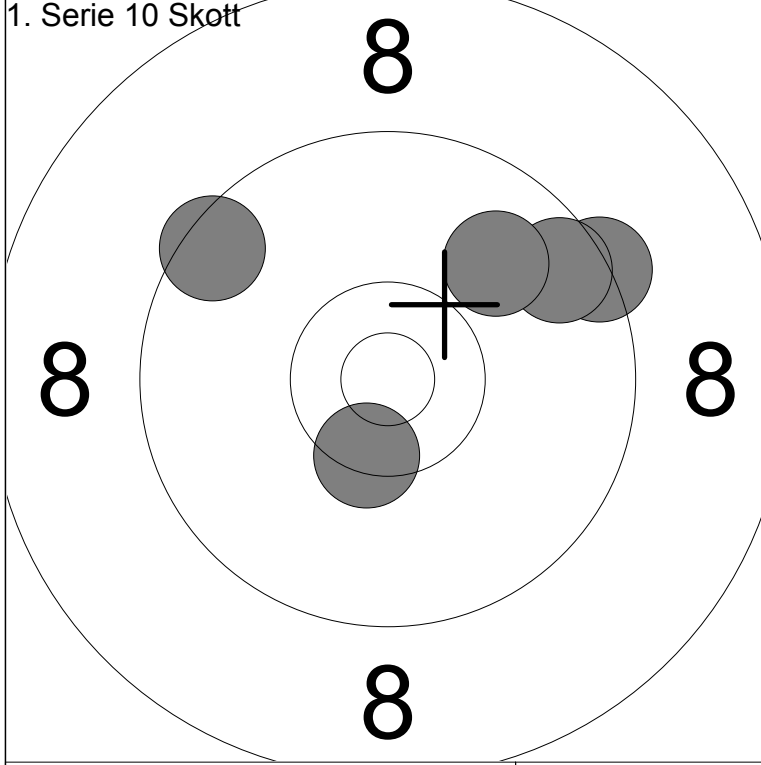

6: 10.4x ↓	Serie	46
7: 9.4 ↗		
8: 9.6 ↗	Total	267
9: 9.9 ↗		
10: 9.5 ↖		

1: 8.2 ↓	Serie	35
2: 10.4x ↙		
3: 5.0 →	Total	302
4: 3.5 →		
5: 9.6 →		