

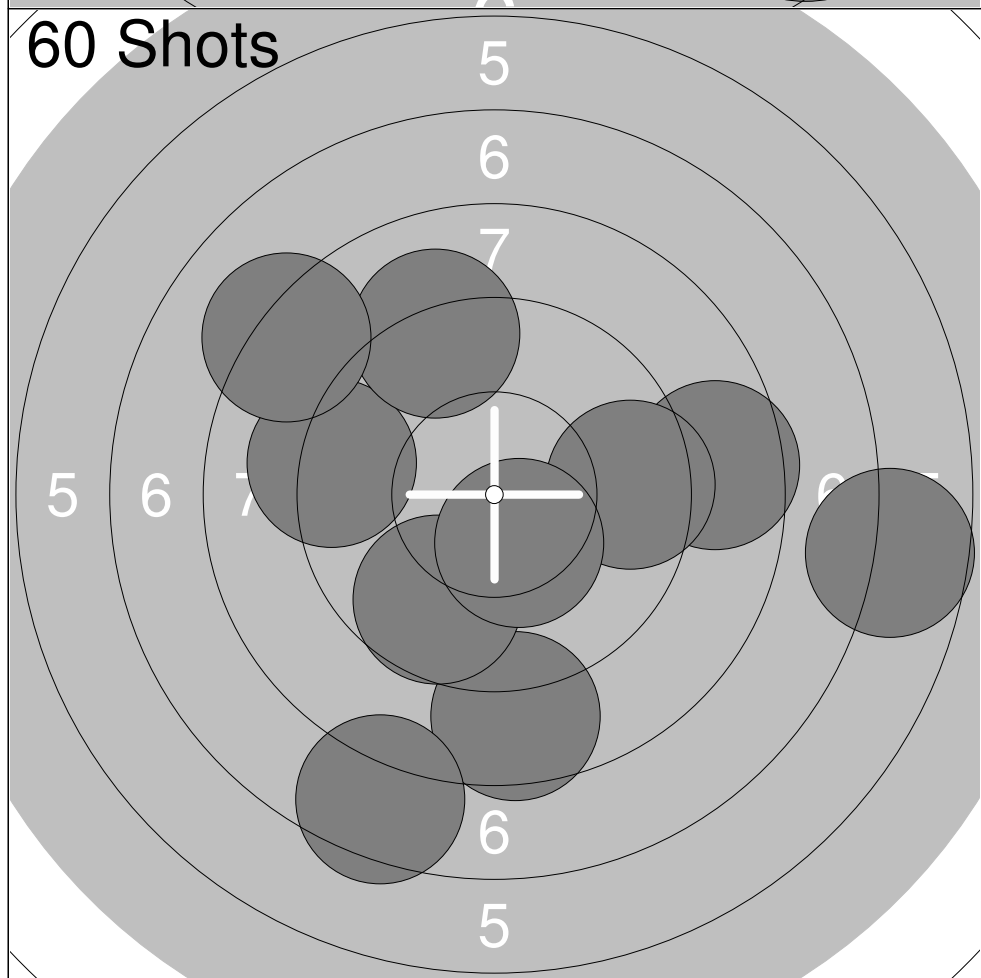

1:	7.6	↘
2:	10.4x	↑
3:	8.7	↗
4:	10.6x	→
5:	8.4	↖
6:	10.1	↙
7:	9.0	↗

<b>Series</b>	<b>64.8</b>
<b>Total</b>	<b>336.0</b>



1:	8.6	↓
2:	6.7	→
3:	9.2	←
4:	9.1	↗
5:	8.2	↖
6:	7.5	↘
7:	9.7	↙
8:	8.6	→
9:	9.5	→
10:	10.4x	↓

<b>Series</b>	<b>87.5</b>
<b>Total</b>	<b>423.5</b>

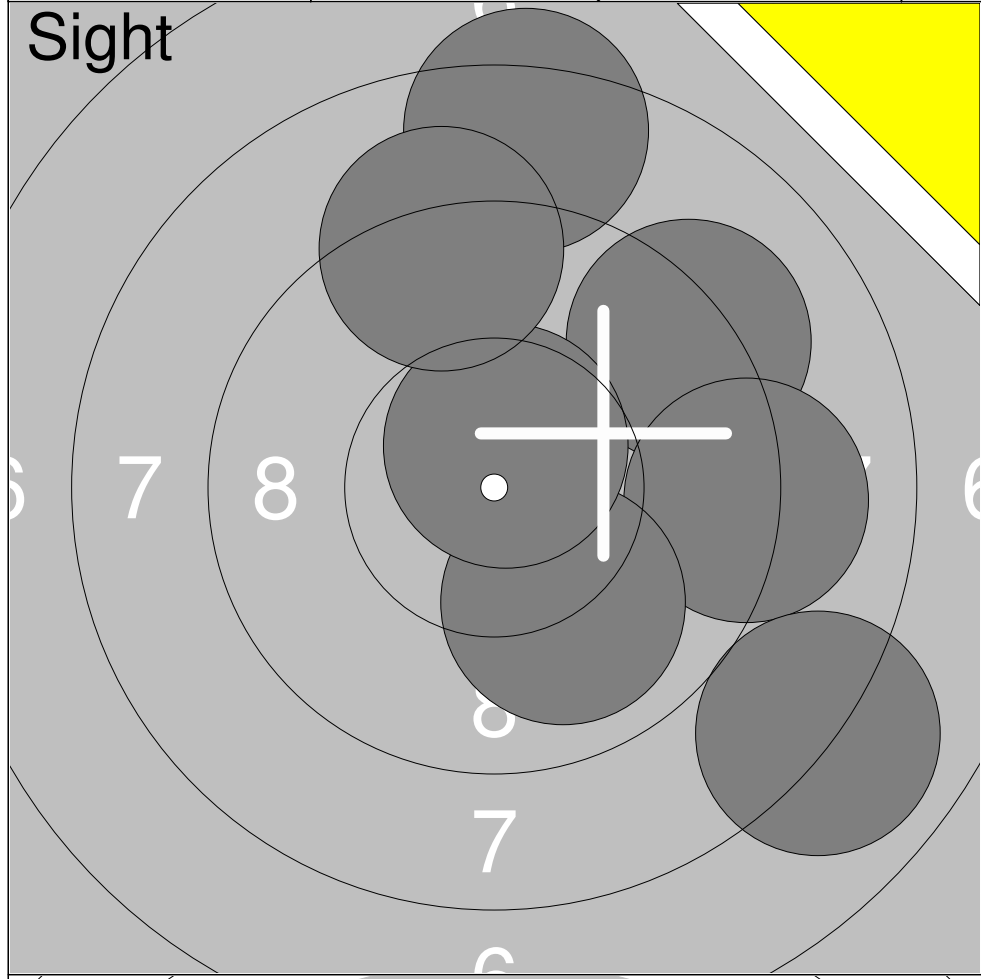

1:	8.3	↑
2:	9.2	↗
3:	9.1	→
4:	8.0	↘
5:	10.0	↘
6:	10.6x	↑
7:	9.2	↑

<b>Series</b>	<b>64.4</b>
<b>Total</b>	<b>330.0</b>

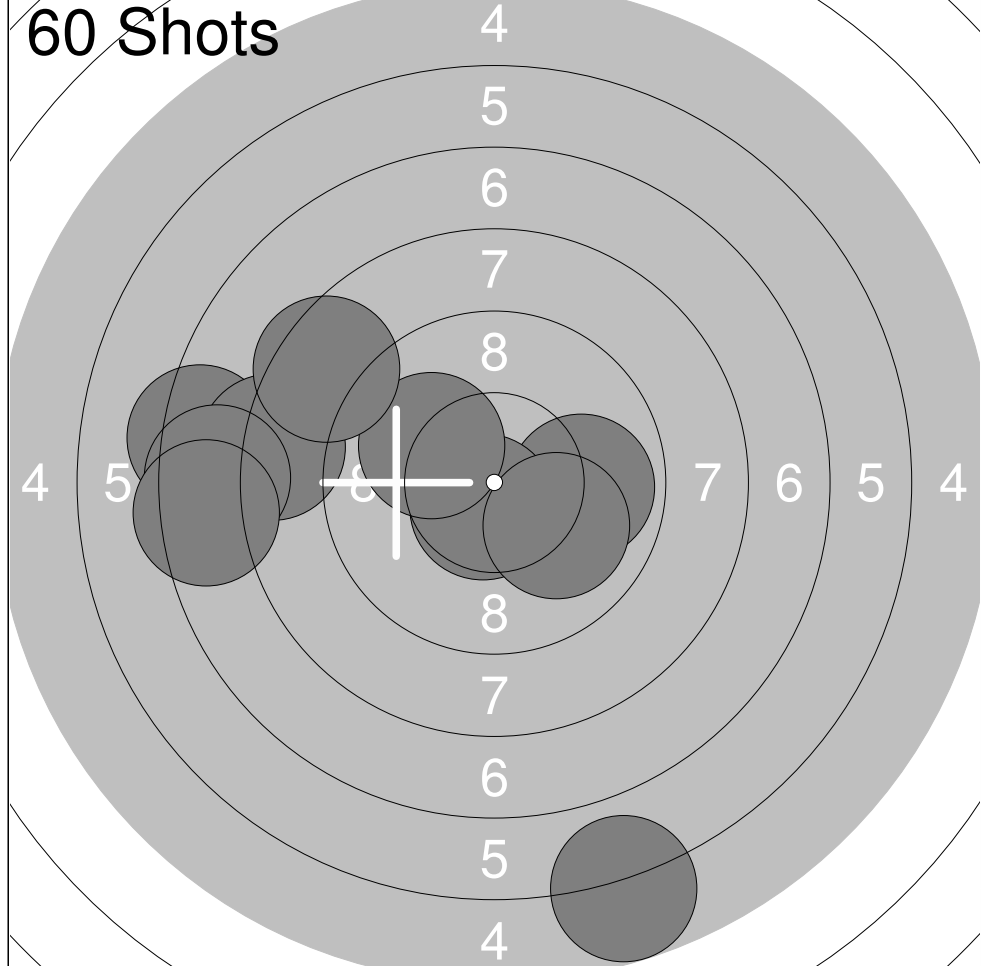

1:	7.3	←
2:	9.9	→
3:	10.6x	↘
4:	10.1	↖
5:	8.2	←
6:	7.6	←
7:	8.5	↗
8:	7.4	←
9:	10.0	↘
10:	5.7	↘

<b>Series</b>	<b>85.3</b>
<b>Total</b>	<b>415.3</b>

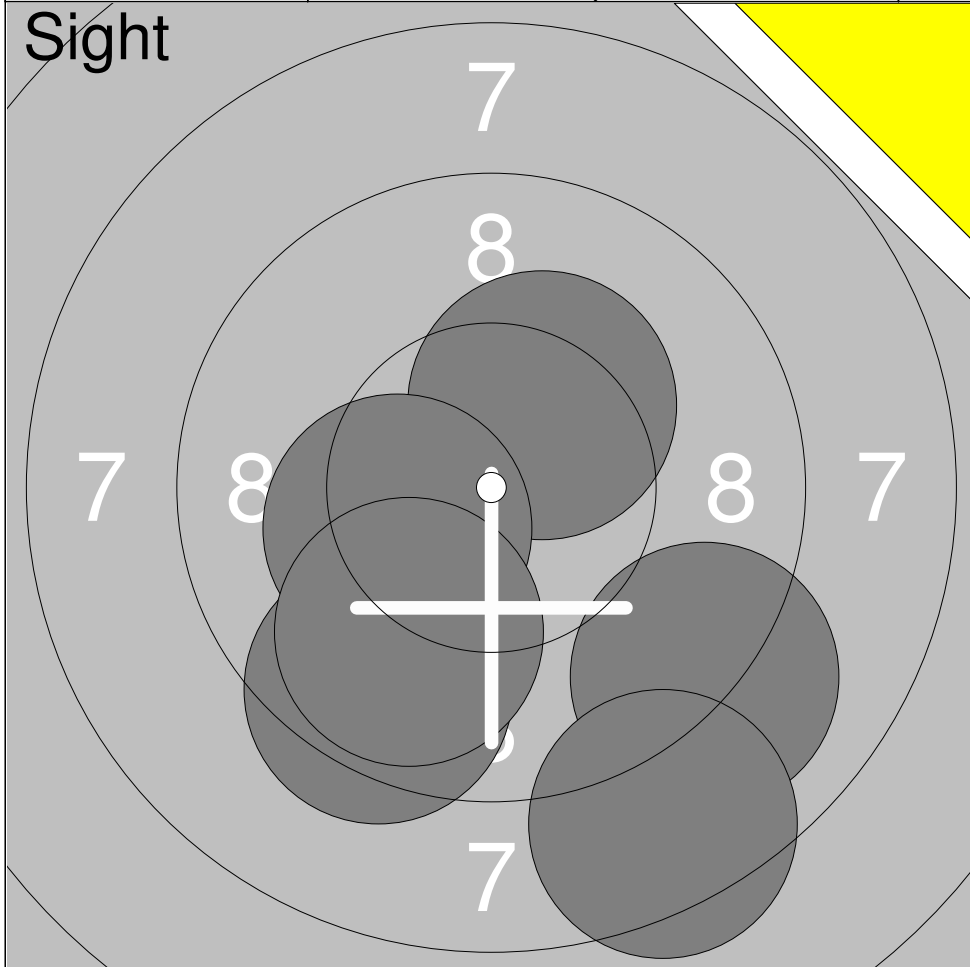

1:	10.3x	↗
2:	9.0	↘
3:	10.3x	↖
4:	9.4	↙
5:	8.4	↘
6:	9.8	↘

Series	57.2
Total	379.0

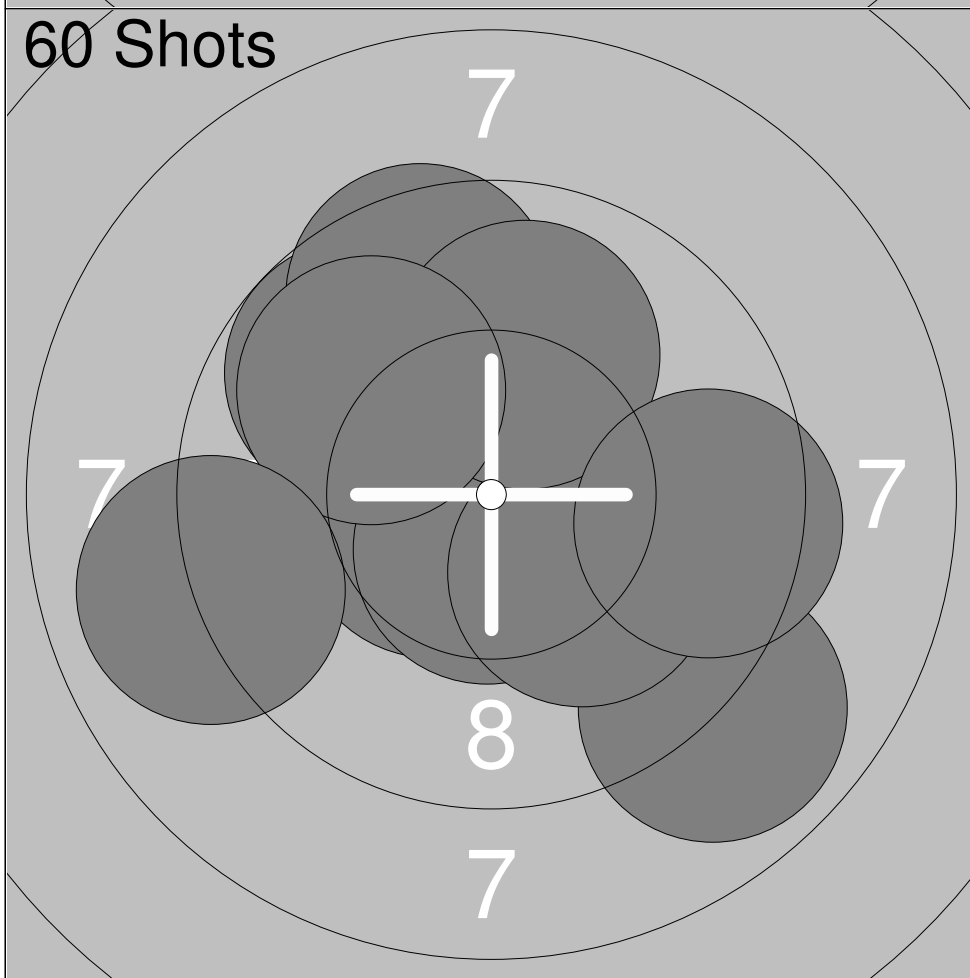

1:	9.7	↗
2:	10.5x	↖
3:	10.6x	↓
4:	8.9	↘
5:	10.2x	↘
6:	9.6	↗
7:	10.0	↗
8:	9.9	↗
9:	9.5	→
10:	9.0	↖

Series	97.9
Total	476.9

Relay	Lane	Erika Bergqvist	
3	10		

S	Umeå		
---	------	--	--

2016-01-23	Förbundsmästerskap 2016	Umeå skytteallians
------------	-------------------------	--------------------

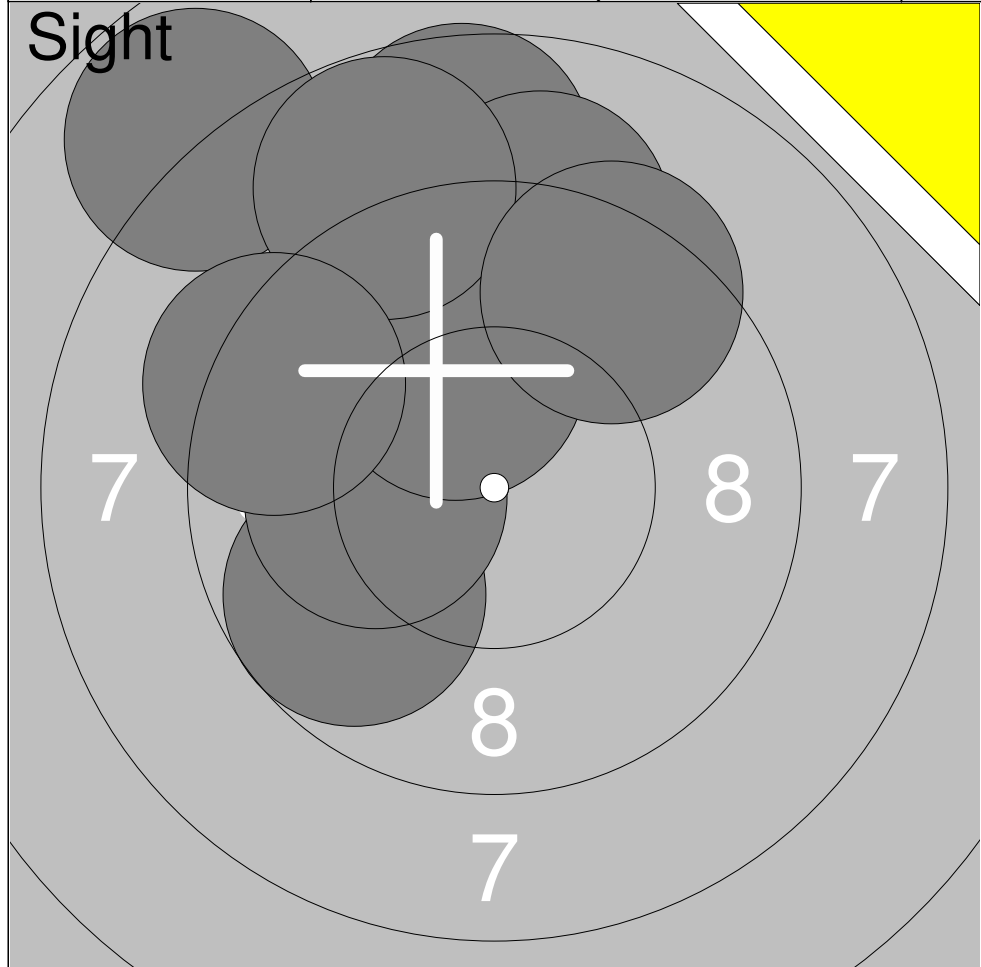

1:	8.7	↑
2:	9.7	↙
3:	10.1	←
4:	9.1	↑
5:	10.1	↑
6:	7.8	↗
7:	8.8	↑
8:	9.4	↗
9:	9.3	↙

<b>Series</b>	<b>83.0</b>
<b>Total</b>	<b>375.0</b>

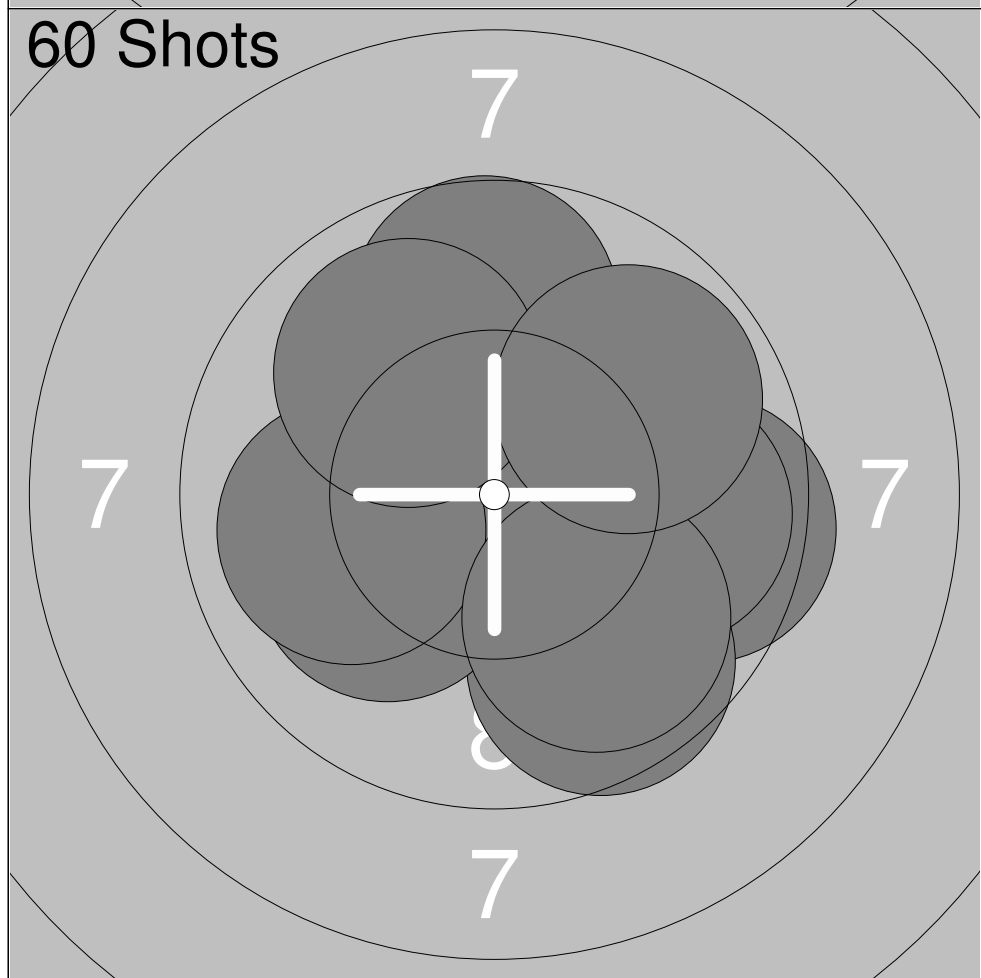

1:	9.5	→
2:	9.9	→
3:	9.6	↘
4:	10.1	↙
5:	10.6x	↑
6:	9.7	↑
7:	10.0	←
8:	10.0	↗
9:	9.9	↘
10:	9.9	↗

<b>Series</b>	<b>99.2</b>
<b>Total</b>	<b>474.2</b>

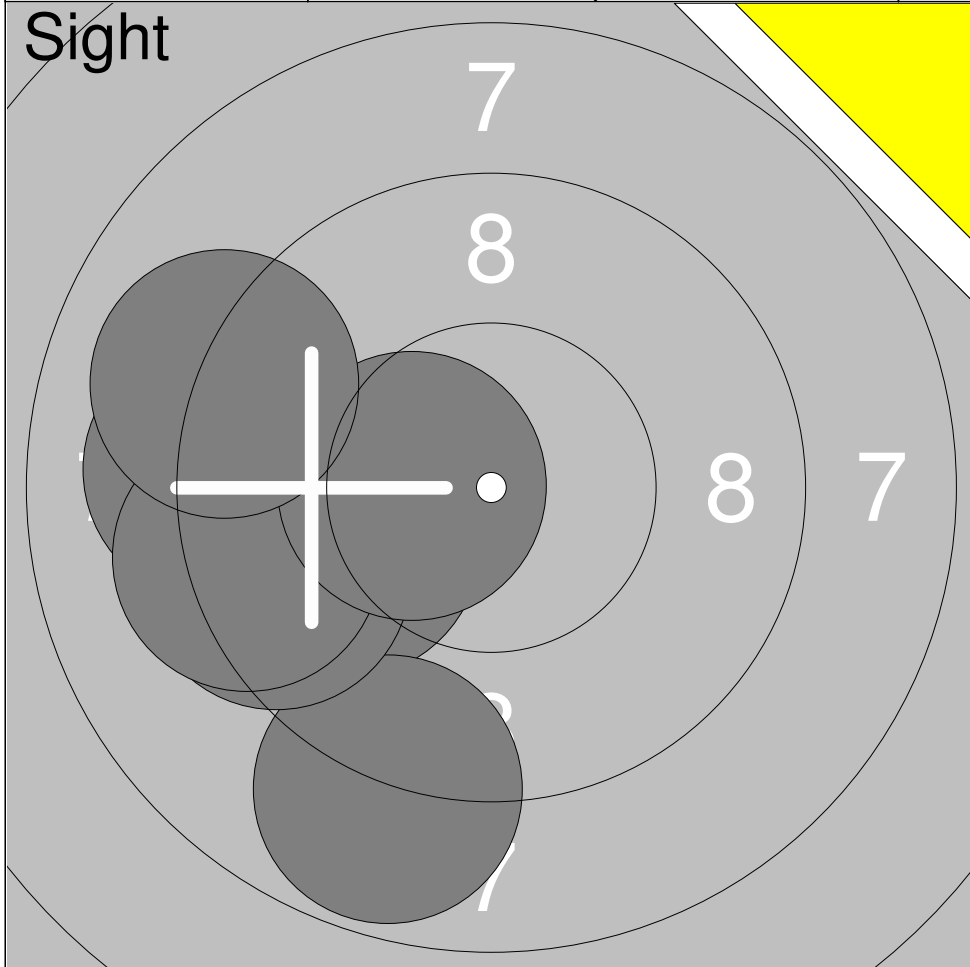

1:	9.1	←
2:	9.9	←
3:	8.8	↘
4:	9.4	←
5:	9.3	←
6:	10.4x	←
7:	9.0	←

<b>Series</b>	<b>65.9</b>
<b>Total</b>	<b>373.0</b>



1:	10.5x	↗
2:	10.6x	↘
3:	9.2	↘
4:	10.4x	↑
5:	9.2	←
6:	10.7x	→
7:	9.5	↗
8:	9.4	↘
9:	10.7x	↑
10:	10.2x	↗

<b>Series</b>	<b>100.4</b>
<b>Total</b>	<b>473.4</b>

Relay <b>3</b>	Lane <b>12</b>	<b>Oscar Jacobsson</b>	
S		Ramselefors	
2016-01-23		Förbundsmästerskap 2016	Umeå skytteallians



1:	10.3x	→
2:	9.5	↙
3:	9.9	↗
4:	10.3x	↖
5:	9.1	↘
6:	9.2	↙

<b>Series</b>	<b>58.3</b>
<b>Total</b>	<b>373.0</b>



1:	10.4x	↖
2:	10.0	↖
3:	9.9	↘
4:	10.7x	↖
5:	10.2x	↘
6:	9.4	→
7:	8.6	↗
8:	8.9	↖
9:	8.8	↖
10:	9.9	↘

<b>Series</b>	<b>96.8</b>
<b>Total</b>	<b>469.8</b>

Relay <b>3</b>	Lane <b>13</b>	<b>Emma Johansson</b>
-------------------	-------------------	-----------------------

S	Vännäs	
---	--------	--

2016-01-23	Förbundsmästerskap 2016	Umeå skytteallians
------------	-------------------------	--------------------

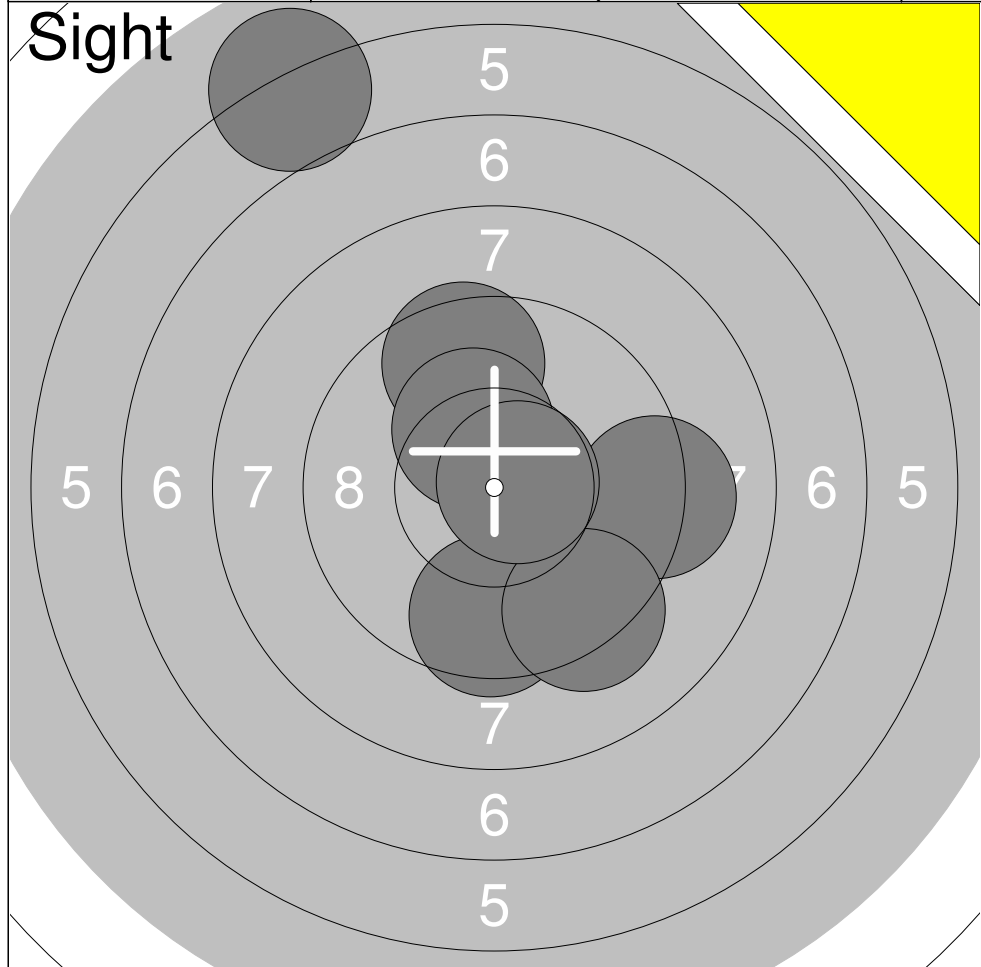

1:	6.0	↗
2:	9.5	↓
3:	9.2	→
4:	9.3	↘
5:	9.5	↗
6:	10.3x	↗
7:	10.7x	→

<b>Series</b>	<b>64.5</b>
<b>Total</b>	<b>369.0</b>



1:	8.9	↗
2:	10.5x	↓
3:	9.8	←
4:	9.1	↗
5:	9.6	→
6:	9.9	↗
7:	9.9	↗
8:	10.7x	↘
9:	9.4	↗
10:	10.0	↗

<b>Series</b>	<b>97.8</b>
<b>Total</b>	<b>466.8</b>

Relay <b>3</b>	Lane <b>14</b>	<b>Hanna Lundin</b>	
S	Umeå		
2016-01-23	Förbundsmästerskap 2016	Umeå skytteallians	



1:	9.9	↘
2:	9.9	↙
3:	9.9	↘
4:	9.2	↗
5:	10.2x	←
6:	10.4x	↙
7:	8.3	↙
8:	10.2x	↗

Series	78.0
Total	367.0

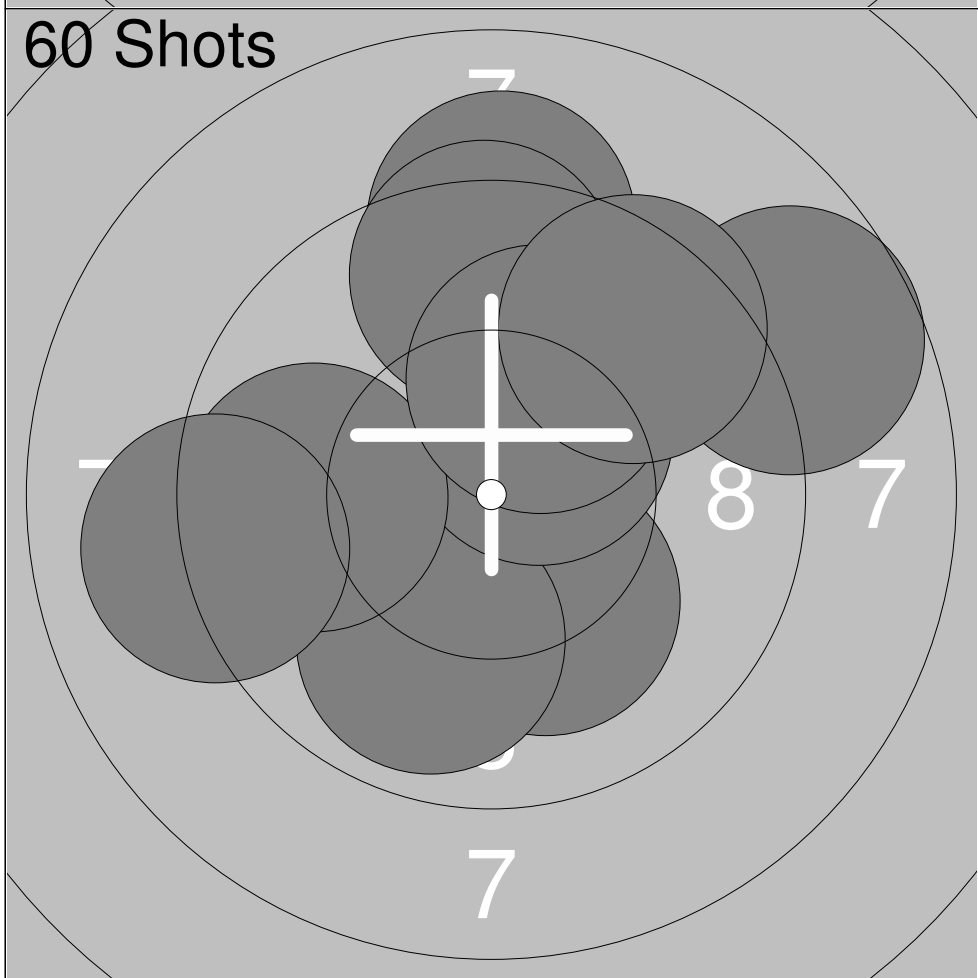

1:	10.2x	↘
2:	9.9	↙
3:	10.4x	↗
4:	8.7	↗
5:	9.8	←
6:	9.1	←
7:	9.2	↑
8:	9.5	↑
9:	10.1	↗
10:	9.5	↗

Series	96.4
Total	463.4



Relay	Lane	Filip Landström	
3	15		
S	Bjurholm-Balsjö		
2016-01-23	Förbundsmästerskap 2016	Umeå skytteallians	

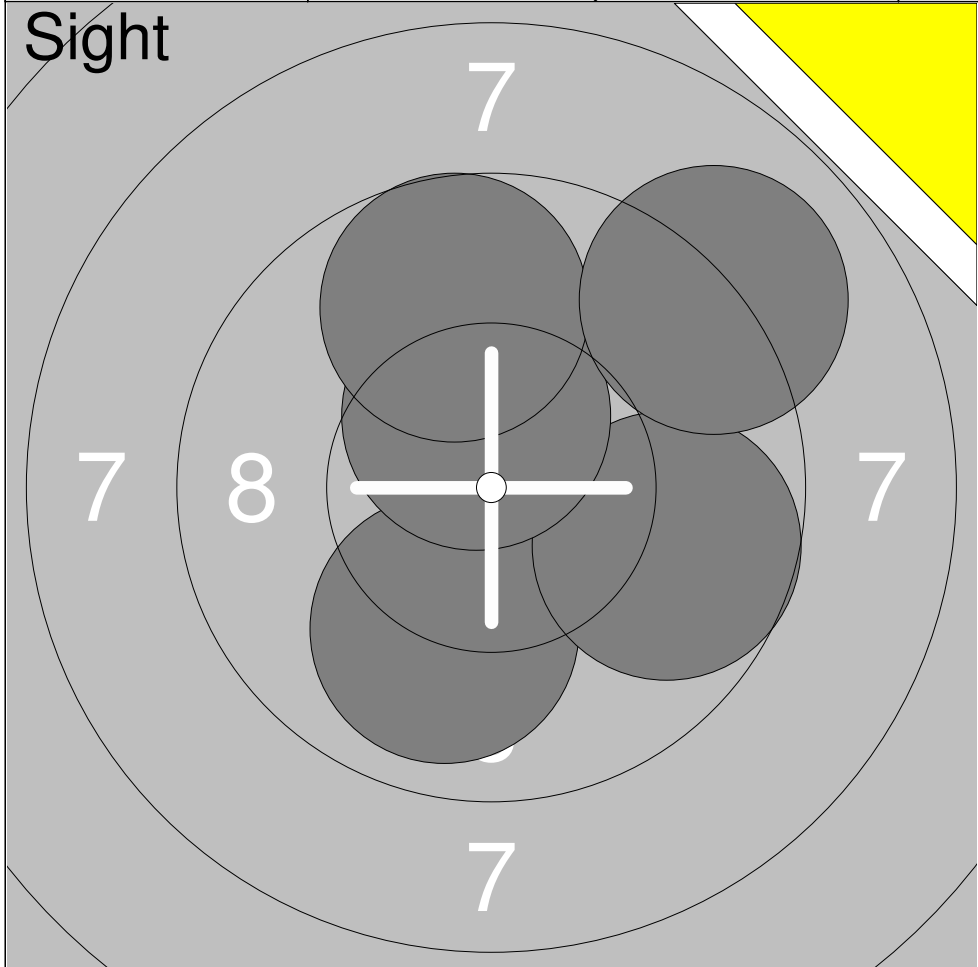

1:	10.0	↓
2:	9.7	→
3:	10.5x	↑
4:	9.7	↑
5:	9.0	↗
<b>Series</b>	<b>48.9</b>	
<b>Total</b>	<b>364.0</b>	

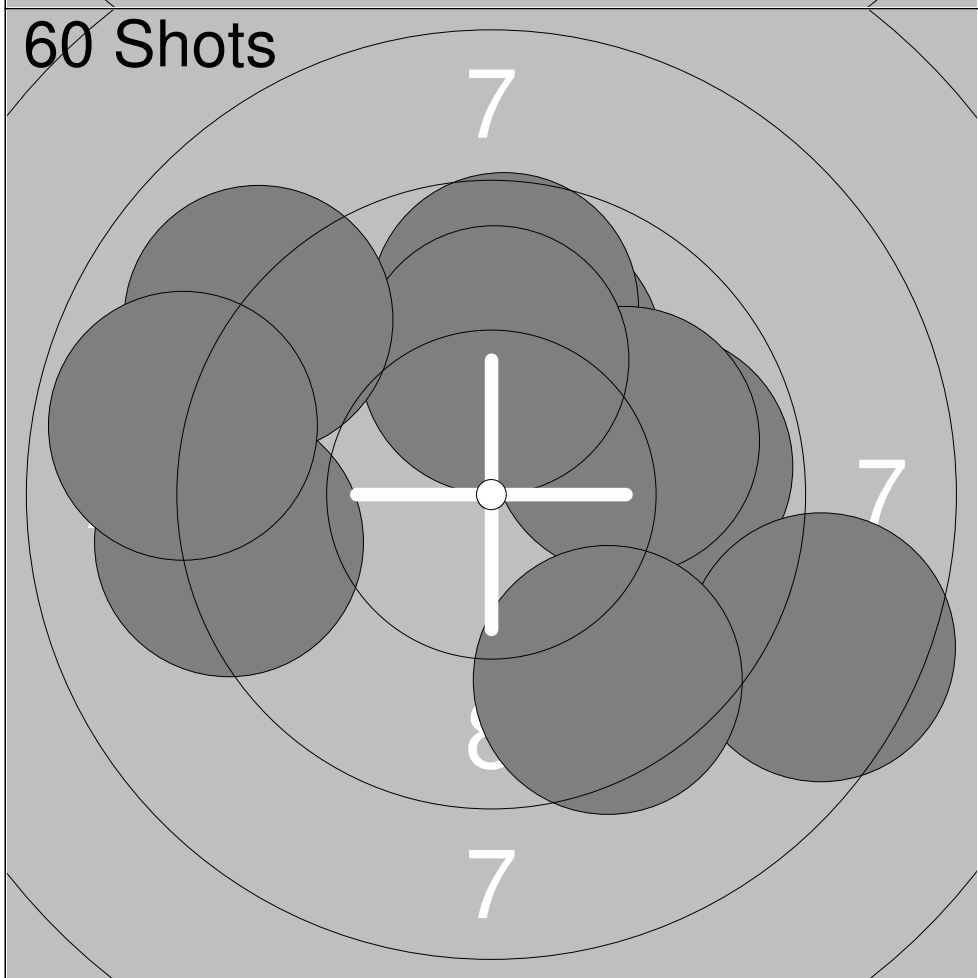

1:	9.8	→
2:	10.0	↑
3:	9.7	↑
4:	10.0	→
5:	8.5	→
6:	10.0	↑
7:	9.0	↗
8:	9.2	←
9:	8.8	←
10:	9.5	↓
<b>Series</b>	<b>94.5</b>	
<b>Total</b>	<b>458.5</b>	

Relay <b>3</b>	Lane <b>16</b>	<b>Emma Eriksson</b>	
S	Bjurholm-Balsjö		
2016-01-23	Förbundsmästerskap 2016	Umeå skytteallians	

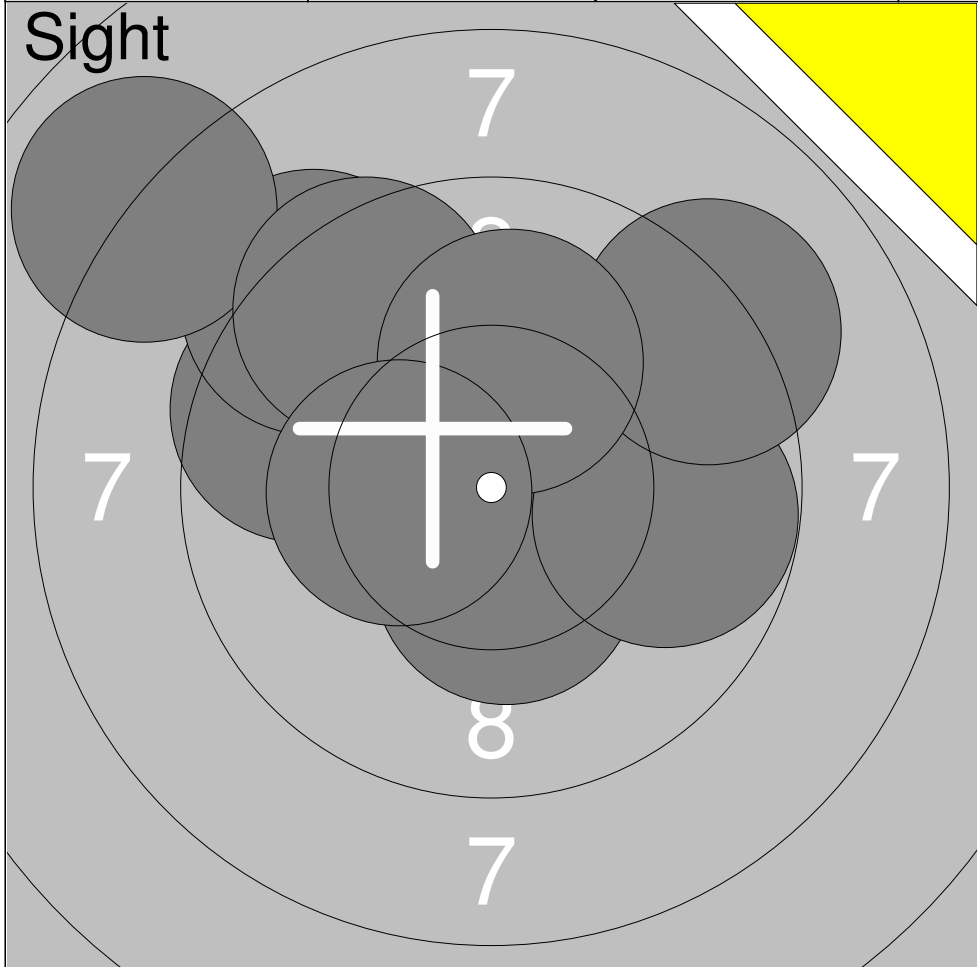

1:	9.7	↗
2:	9.6	↖
3:	10.4x	↘
4:	9.2	↗
5:	7.9	↗
6:	9.5	↗
7:	9.8	→
8:	9.1	↗
9:	10.1	↑
10:	10.3x	←

<b>Series</b>	<b>95.6</b>
<b>Total</b>	<b>363.0</b>

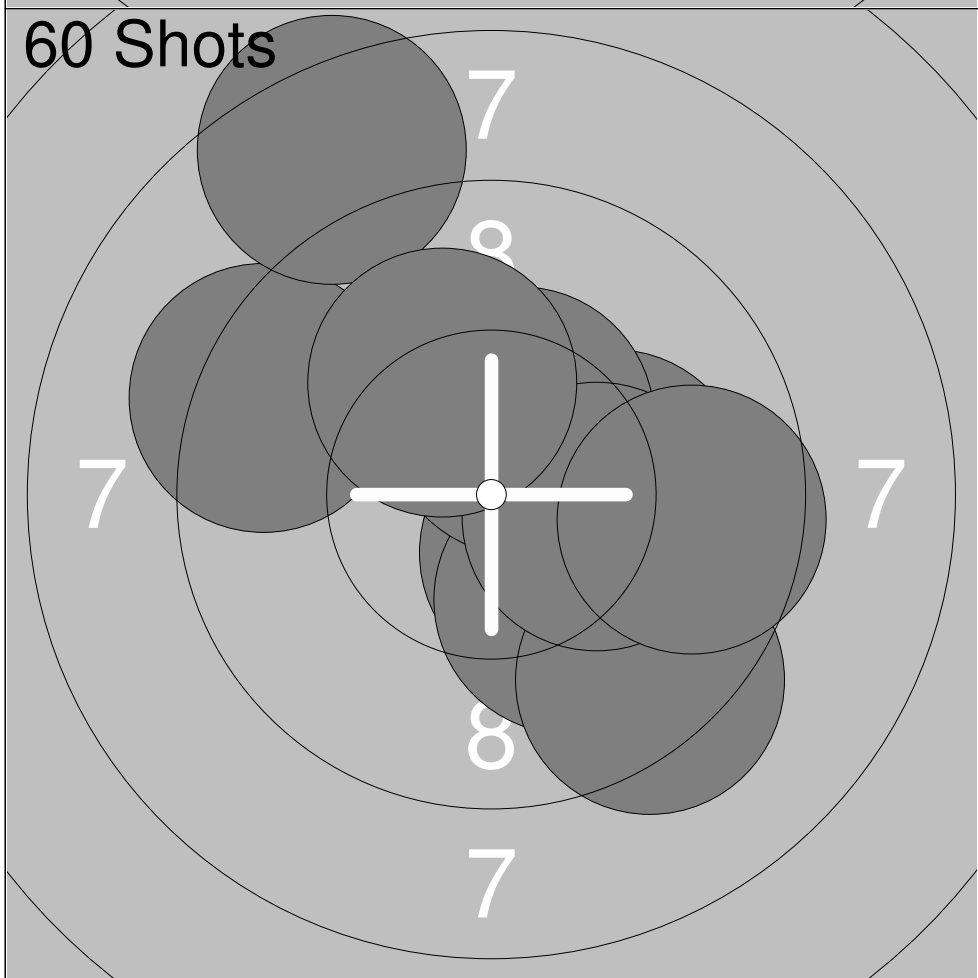

1:	10.4x	↘
2:	10.1	↘
3:	10.1	→
4:	9.3	↘
5:	10.4x	↗
6:	9.3	↖
7:	8.4	↗
8:	10.2x	→
9:	10.1	↗
10:	9.6	→

<b>Series</b>	<b>97.9</b>
<b>Total</b>	<b>460.9</b>

Relay <b>3</b>	Lane <b>17</b>	<b>Karin Johansson</b>
-------------------	-------------------	------------------------

S	Vännäs	
---	--------	--

2016-01-23	Förbundsmästerskap 2016	Umeå skytteallians
------------	-------------------------	--------------------

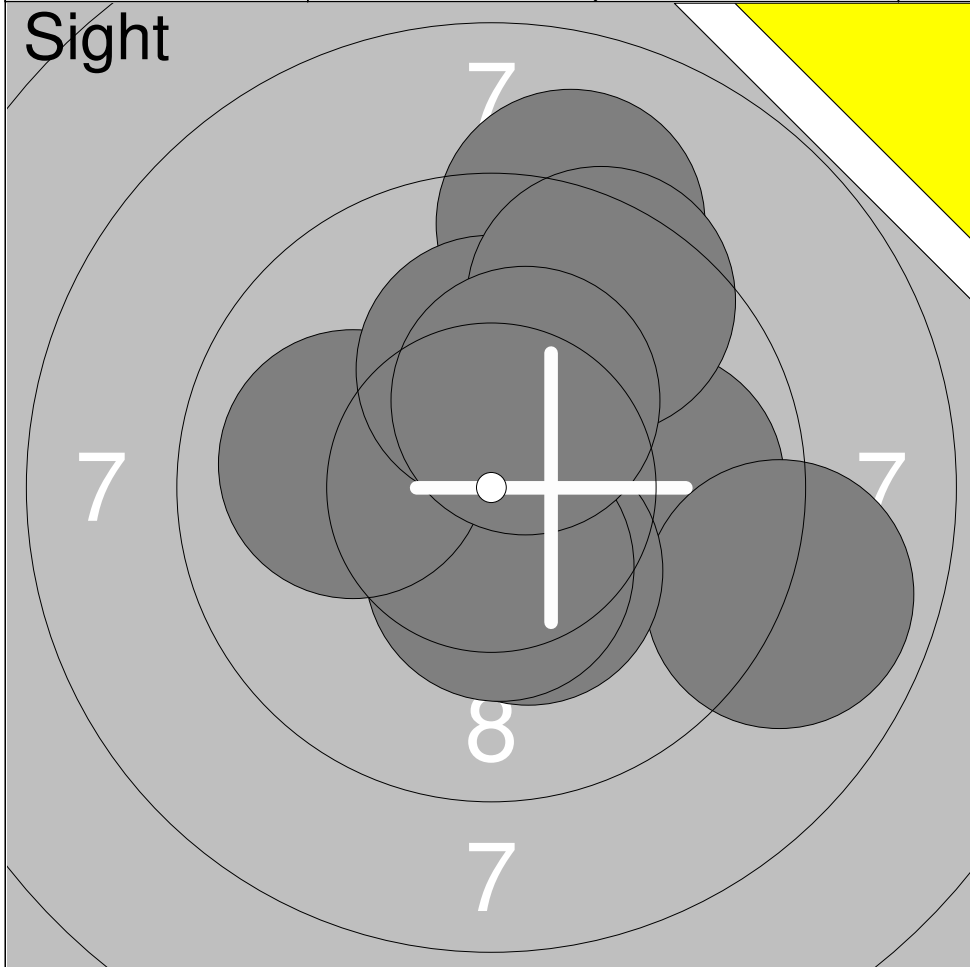

1:	9.1	↑
2:	9.9	→
3:	8.9	→
4:	10.3x	↓
5:	10.4x	↓
6:	10.0	←
7:	10.2x	↑
8:	9.5	↗
9:	10.3x	↑

<b>Series</b>	<b>88.6</b>
<b>Total</b>	<b>363.0</b>



1:	9.7	→
2:	7.8	←
3:	9.7	←
4:	10.2x	←
5:	10.0	←
6:	9.3	↓
7:	8.3	←
8:	8.7	↗
9:	7.5	→
10:	9.9	→

<b>Series</b>	<b>91.1</b>
<b>Total</b>	<b>454.1</b>

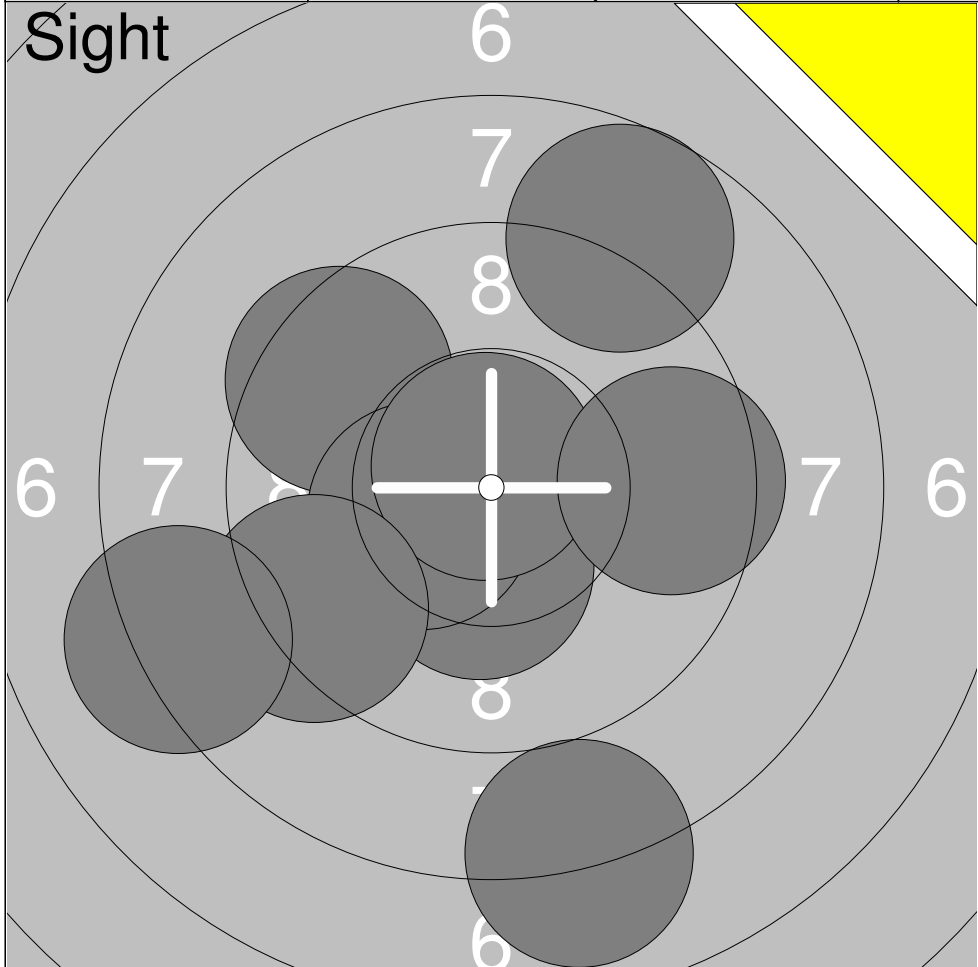

1:	8.0	↓
2:	9.5	↖
3:	10.3x	↓
4:	10.4x	←
5:	8.7	↗
6:	10.8x	↑
7:	9.5	→
8:	9.3	↙
9:	8.2	↙

<b>Series</b>	<b>84.7</b>
<b>Total</b>	<b>352.0</b>



1:	10.0	↓
2:	9.1	←
3:	9.2	→
4:	10.0	↗
5:	10.7x	→
6:	8.0	→
7:	10.1	↗
8:	8.3	↓
9:	8.1	↗
10:	8.7	→

<b>Series</b>	<b>92.2</b>
<b>Total</b>	<b>444.2</b>

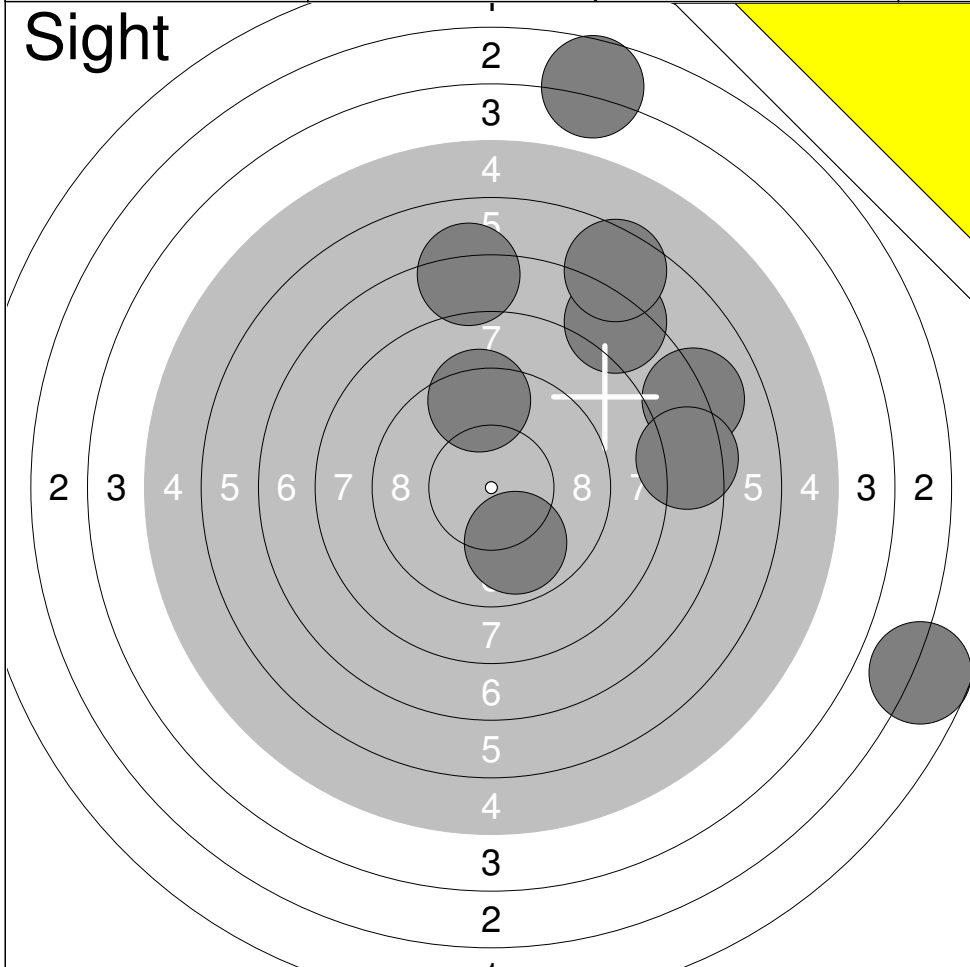

1:	3.7	↑
2:	7.1	→
3:	2.7	→
4:	7.5	→
5:	9.4	↑
6:	7.3	↗
7:	9.9	↓
8:	6.6	↗
9:	7.2	↑

<b>Series</b>	<b>61.4</b>
<b>Total</b>	<b>347.0</b>



1:	8.0	↗
2:	8.7	↗
3:	8.2	→
4:	7.1	↗
5:	9.4	←
6:	7.8	↑
7:	8.6	↗
8:	10.6x	→
9:	7.9	↑
10:	7.6	↑

<b>Series</b>	<b>83.9</b>
<b>Total</b>	<b>430.9</b>

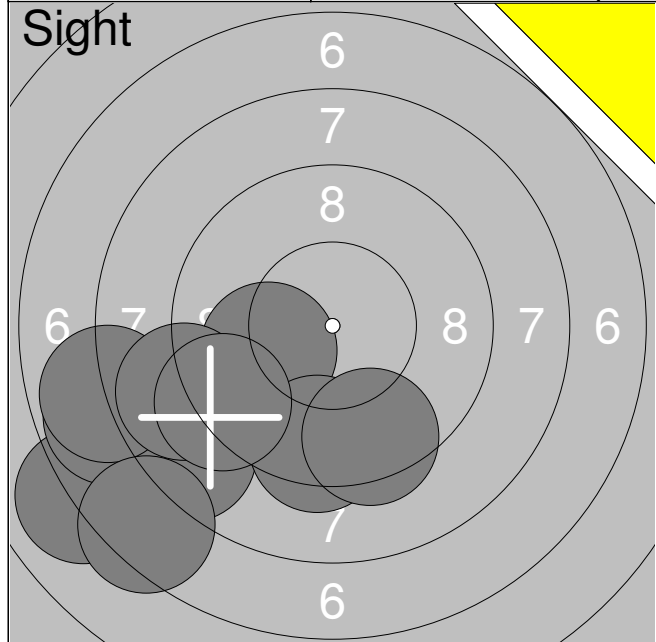

1:	7.0	↙
2:	8.4	↙
3:	10.1	↙
4:	7.8	↙
5:	7.9	↙
6:	9.4	↓
7:	7.4	↙
8:	8.8	↙
9:	9.4	↓
10:	9.2	↙
<b>Series</b>		<b>85.4</b>
<b>Total</b>		<b>300.0</b>

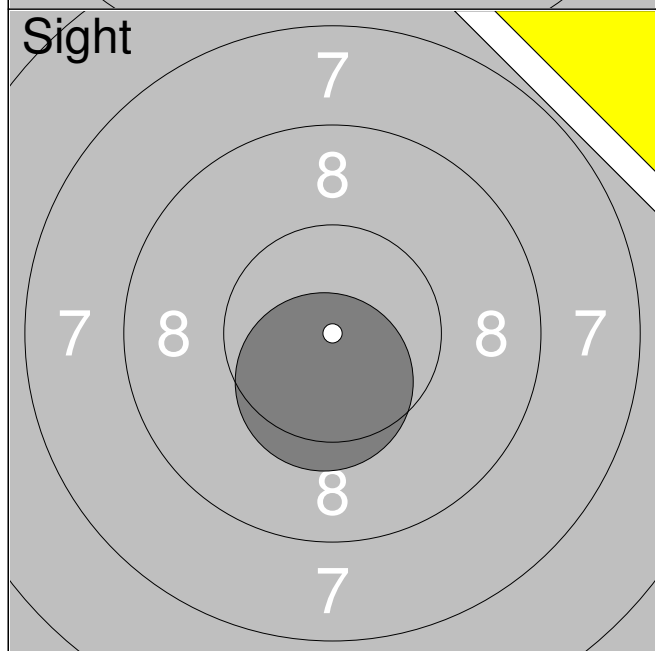

11:	10.5x	↓
<b>Series</b>		<b>10.5</b>
<b>Total</b>		<b>300.0</b>

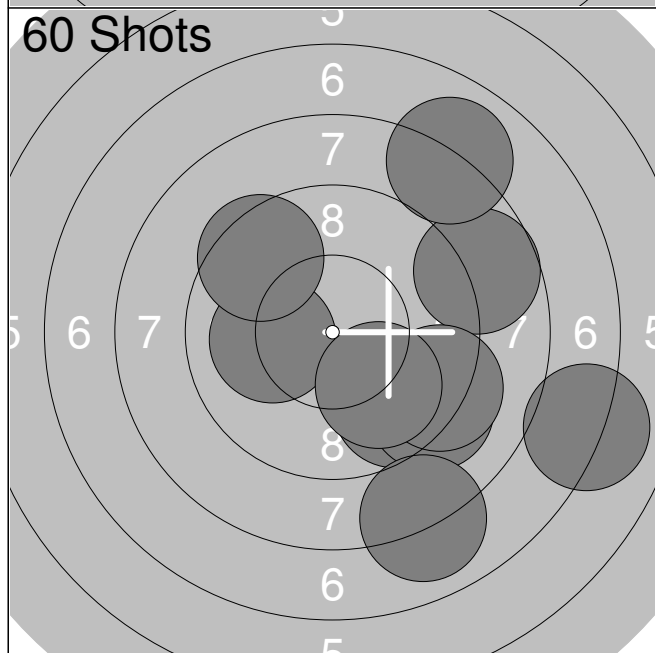

1:	10.1	↙
2:	9.6	↓
3:	8.7	→
4:	9.2	↓
5:	9.5	↗
6:	9.2	↘
7:	10.0	↓
8:	7.1	→
9:	8.0	↗
10:	8.0	↓
<b>Series</b>		<b>89.4</b>
<b>Total</b>		<b>389.4</b>

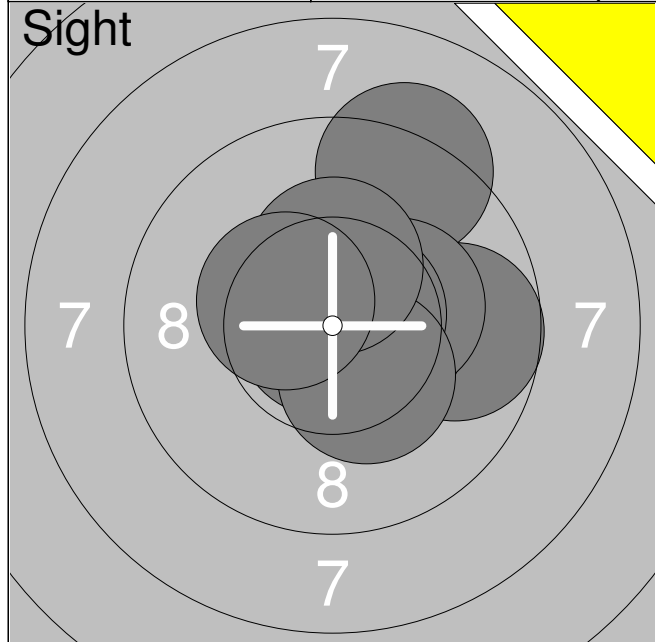

1:	9.2	↗
2:	10.6x	↘
3:	9.7	→
4:	10.5x	↘
5:	10.3x	→
6:	10.7x	↗
7:	10.9x	←
8:	10.3x	↘
9:	10.3x	↑
10:	10.4x	↖
<b>Series</b>	<b>102.9</b>	
<b>Total</b>	<b>400.0</b>	

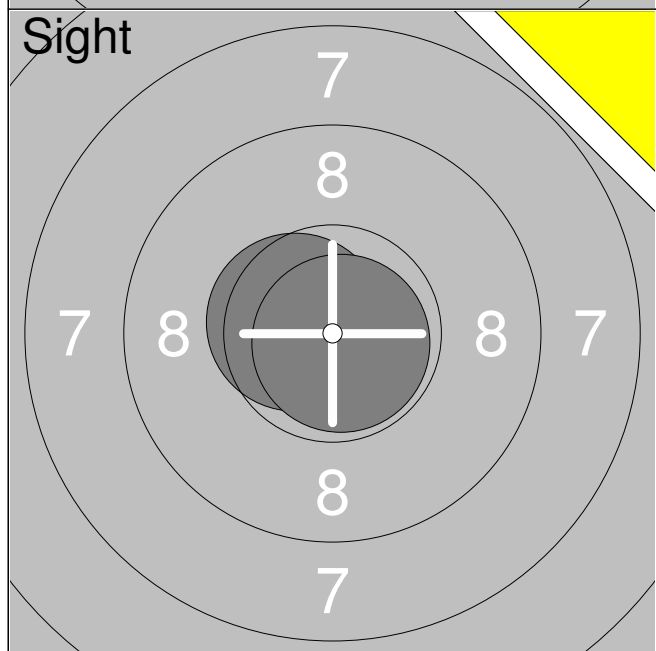

11:	10.6x	↖
12:	10.8x	↘
<b>Series</b>	<b>21.4</b>	
<b>Total</b>	<b>400.0</b>	



1:	10.8x	↖
2:	9.9	↙
3:	10.9x	→
4:	10.7x	↗
5:	10.7x	↘
6:	10.1	↘
7:	10.8x	↑
8:	10.7x	←
9:	10.8x	↑
10:	10.6x	↗
<b>Series</b>	<b>106.0</b>	
<b>Total</b>	<b>506.0</b>	



1:	10.9x	←
2:	10.3x	↓
3:	10.2x	←
4:	10.2x	←
5:	10.8x	←
6:	10.5x	→
7:	10.6x	↓
8:	10.5x	↙
9:	10.6x	→

Series	94.6
Total	400.0



1:	10.5x	↙
2:	10.5x	↓
3:	10.7x	→
4:	10.4x	↓
5:	10.3x	↑
6:	10.6x	↓
7:	10.4x	←
8:	10.6x	→
9:	10.5x	→
10:	10.5x	←

Series	105.0
Total	505.0







1:	10.3x	→
2:	10.5x	↗
3:	10.6x	↓
4:	10.7x	↗
5:	10.7x	↑
6:	10.6x	↖

Series	63.4
Total	399.0



1:	10.6x	→
2:	10.4x	↖
3:	10.3x	←
4:	10.6x	←
5:	10.3x	→
6:	10.9x	↖
7:	10.5x	→
8:	10.7x	↗
9:	10.4x	↖
10:	10.1	↓

Series	104.8
Total	503.8



1:	10.2x	→
2:	10.8x	←
3:	10.5x	→
4:	10.2x	↓
5:	10.9x	↓
6:	10.7x	↖
7:	10.8x	↖

<b>Series</b>	<b>74.1</b>
<b>Total</b>	<b>399.0</b>



1:	10.8x	→
2:	10.6x	→
3:	10.7x	↖
4:	10.5x	←
5:	10.4x	↓
6:	10.7x	→
7:	10.4x	↓
8:	10.8x	↖
9:	10.8x	↙
10:	10.6x	↓

<b>Series</b>	<b>106.3</b>
<b>Total</b>	<b>505.3</b>



1:	10.3x	↑
2:	10.3x	↓
3:	10.4x	↑
4:	10.8x	↗
5:	10.1	←
6:	10.8x	↗
7:	10.5x	↑
8:	10.3x	↑
9:	10.6x	↗
10:	10.6x	↓

Series	104.7
Total	398.0



1:	10.4x	↖
2:	10.1	↖
3:	10.6x	↑
4:	10.6x	↖
5:	10.4x	↗
6:	10.3x	←
7:	10.7x	↖
8:	10.4x	↓
9:	10.5x	↖
10:	10.5x	→

Series	104.5
Total	502.5



1:	10.1	↘
2:	10.3x	→
3:	10.3x	↗
4:	10.7x	←
5:	10.1	↘
6:	10.6x	↗
7:	10.7x	↘
8:	10.4x	↘
9:	10.5x	↘
10:	10.7x	↘
<b>Series</b>	<b>104.4</b>	
<b>Total</b>	<b>398.0</b>	



11:	10.6x	←
12:	10.7x	↘
<b>Series</b>	<b>21.3</b>	
<b>Total</b>	<b>398.0</b>	



1:	10.7x	↗
2:	10.7x	←
3:	10.7x	→
4:	10.5x	←
5:	10.5x	↖
6:	10.7x	→
7:	10.2x	↗
8:	10.5x	↘
9:	10.4x	←
10:	10.4x	→
<b>Series</b>	<b>105.3</b>	
<b>Total</b>	<b>503.3</b>	





1:	10.3x	←
2:	10.8x	↑
3:	10.3x	↑
4:	10.5x	↗
5:	10.4x	→
6:	10.7x	↑
7:	10.2x	↖
8:	9.7	↑
9:	10.5x	↗
10:	10.7x	↖
<b>Series</b>	<b>104.1</b>	
<b>Total</b>	<b>398.0</b>	

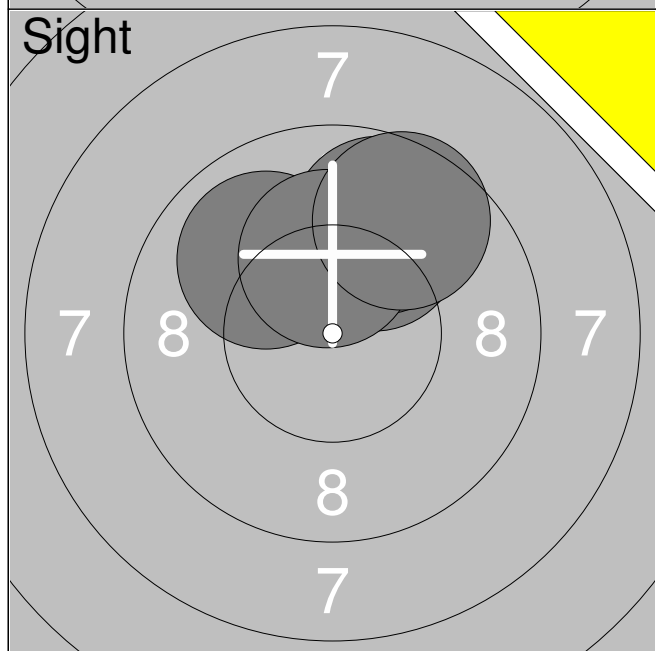

11:	9.9	↗
12:	10.0	↖
13:	9.8	↗
14:	10.2x	↑
15:	9.6	↗
<b>Series</b>	<b>49.5</b>	
<b>Total</b>	<b>398.0</b>	

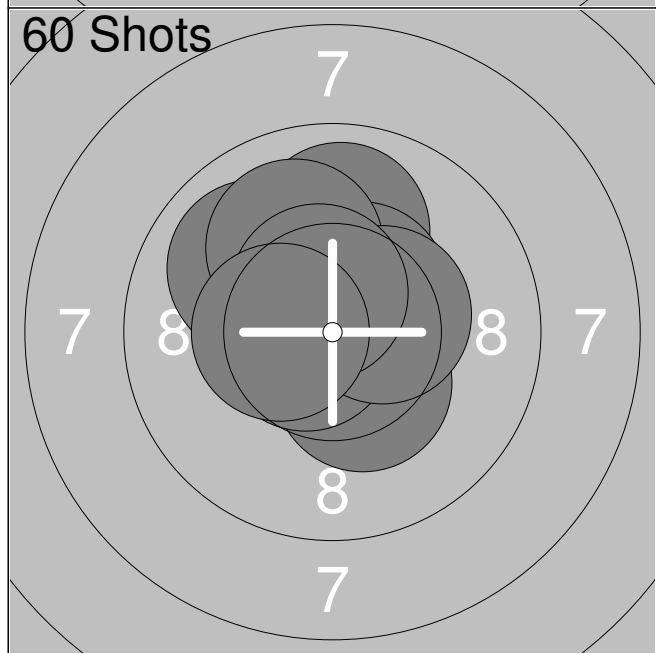

1:	9.9	↑
2:	10.4x	↘
3:	9.9	↖
4:	10.7x	←
5:	10.6x	↖
6:	10.4x	↗
7:	10.0	↑
8:	10.4x	→
9:	10.5x	↑
10:	10.4x	←
<b>Series</b>	<b>103.2</b>	
<b>Total</b>	<b>501.2</b>	

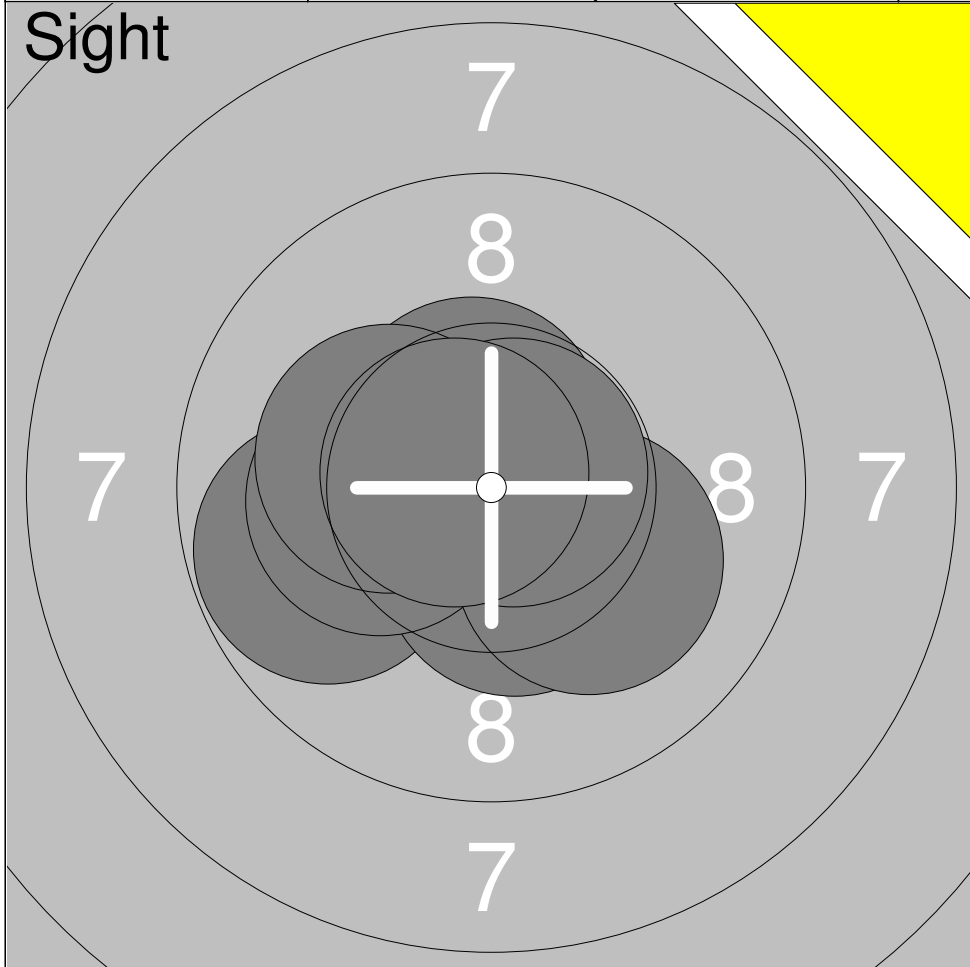

1:	10.5x	↓
2:	9.8	←
3:	10.4x	↓
4:	10.6x	↑
5:	10.4x	←
6:	10.2x	←
7:	10.2x	←
8:	10.1	↘
9:	10.8x	↗
10:	10.7x	←

Series	103.7
Total	398.0



1:	10.2x	↑
2:	10.0	←
3:	10.1	↗
4:	10.3x	→
5:	10.8x	↑
6:	10.7x	←
7:	10.5x	↗
8:	10.9x	↘
9:	9.9	↑
10:	10.0	←

Series	103.4
Total	501.4