

1: 9.3 ↓	6: 10.1 ↘	Serie 97.0
2: *10.4 ↘	7: *10.5 ↓	
3: 10.0 ↘	8: 10.1 ↗	Total 197.0
4: 9.1 →	9: 9.8 →	
5: 10.0 ↗	10: *10.5 →	

1: 8.6 ←	Serie 43.0
2: 9.6 ↑	
3: 9.9 ↑	Total 240.0
4: 8.1 ↖	
5: 9.8 ↓	

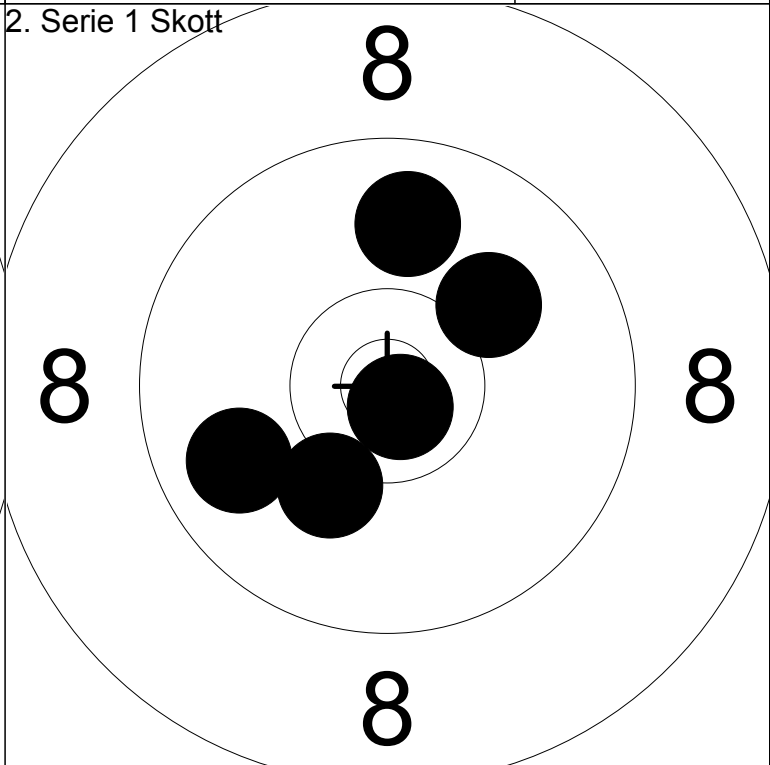
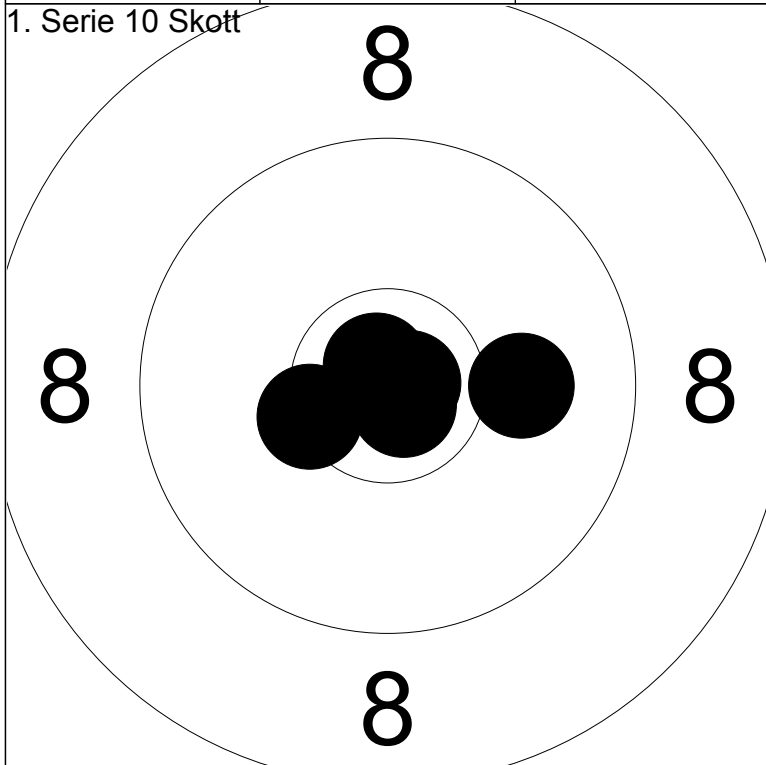

6: *10.4 ←	Serie 50.0
7: 10.1 →	
8: *10.8 →	Total 290.0
9: *10.8 ↘	
10: *10.8 ↗	

1: 9.9 ↑	Serie 48.0
2: 10.2 ↘	
3: *10.8 ↘	Total 338.0
4: 10.1 ↗	
5: 9.8 ←	

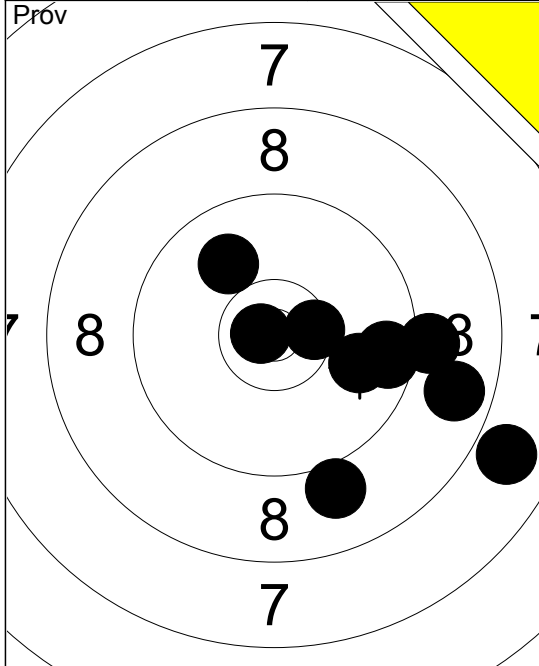

1:	*10.5	→
2:	7.9	↘
3:	8.8	↘
4:	9.0	↘
5:	10.0	↗
6:	9.1	→
7:	9.9	↘
8:	9.6	→
9:	*10.8	←
10:	9.6	→
Serie		90.0
Total		197.0

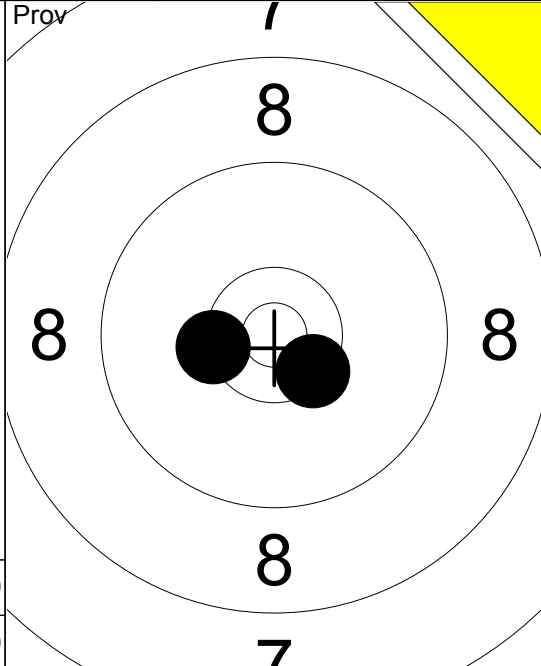

11:	*10.4	↘
12:	*10.4	←
Serie		20.0
Total		197.0

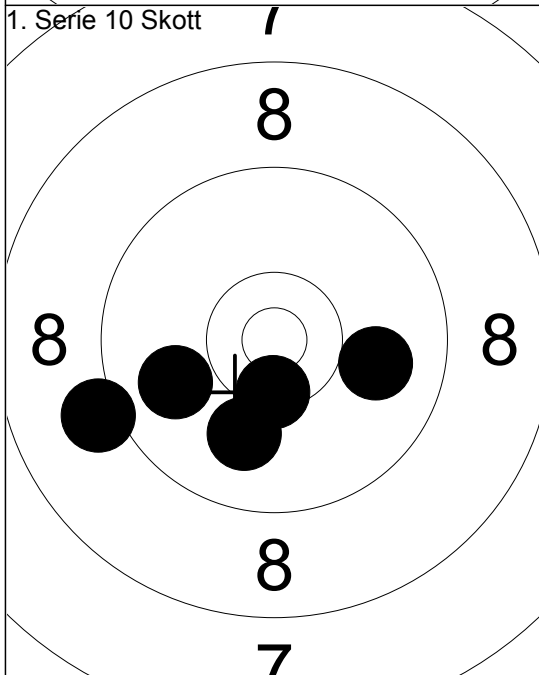

1:	9.1	←
2:	9.9	←
3:	10.0	→
4:	*10.5	↓
5:	10.0	↘
Serie		48.0
Total		245.0

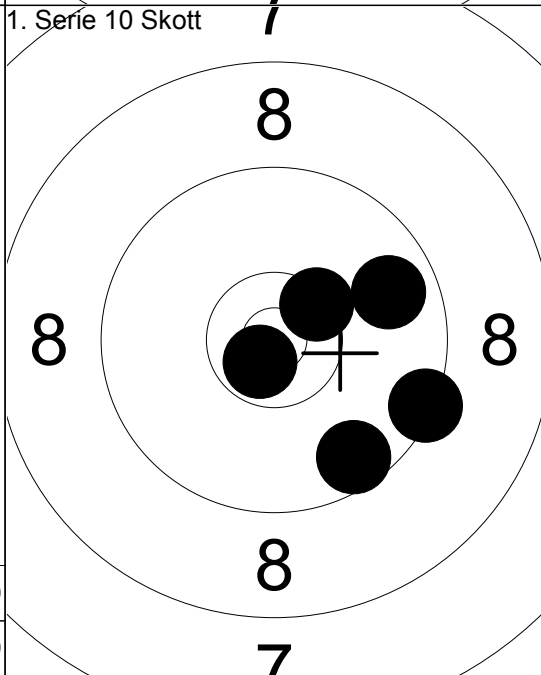

6:	9.8	→
7:	*10.7	↘
8:	*10.4	↗
9:	9.6	↘
10:	9.4	↘
Serie		47.0
Total		292.0

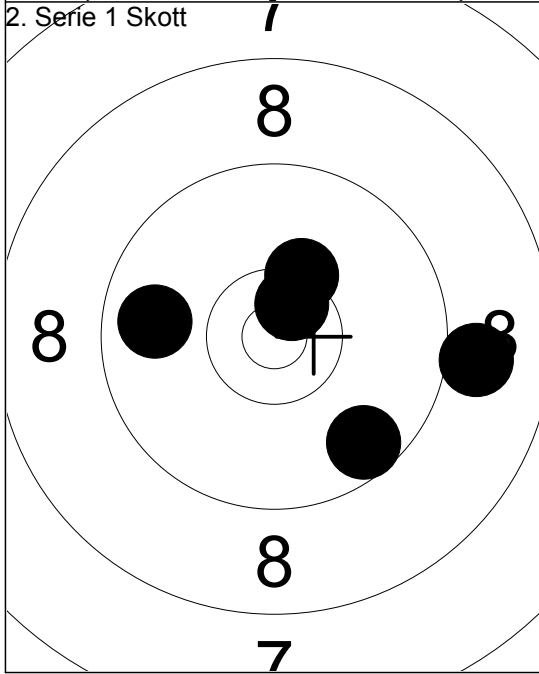

1:	9.0	→
2:	*10.3	↗
3:	9.6	↘
4:	*10.6	↗
5:	9.8	←
Serie		47.0
Total		339.0

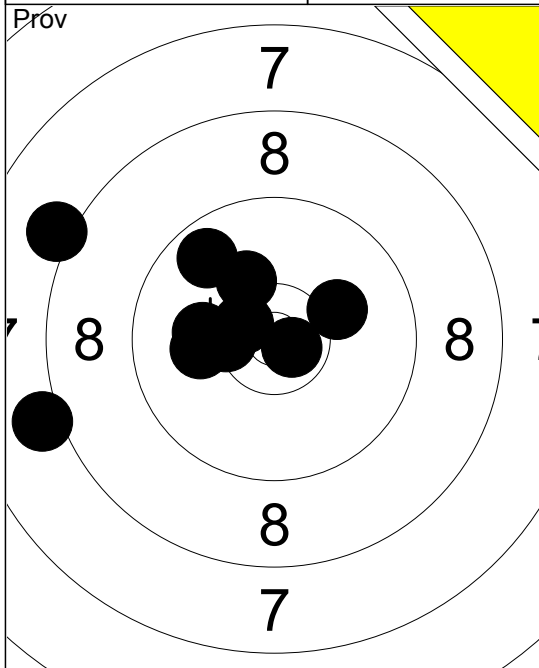

1:	8.1	↖
2:	8.1	←
3:	10.2	↗
4:	10.1	←
5:	10.1	↗
6:	9.7	↗
7:	*10.6	↖
8:	10.1	←
9:	*10.4	←
10:	*10.7	↘
Serie	95.0	
Total	196.0	

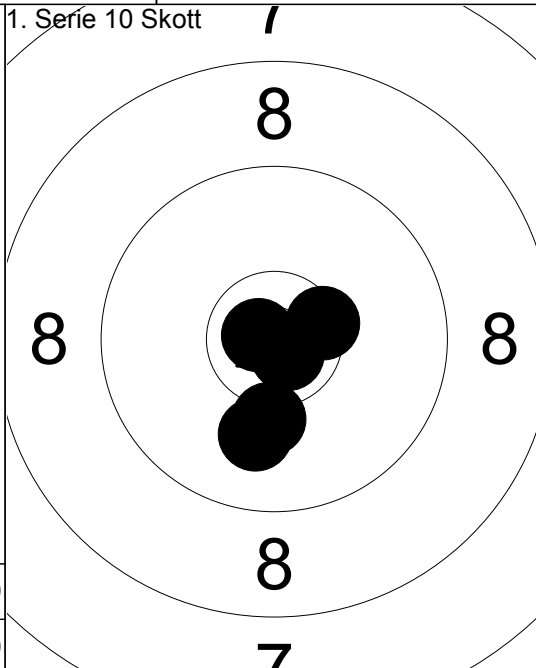

1:	*10.8	↘
2:	10.2	↓
3:	*10.8	←
4:	10.0	↓
5:	*10.5	↗
Serie	50.0	
Total	246.0	

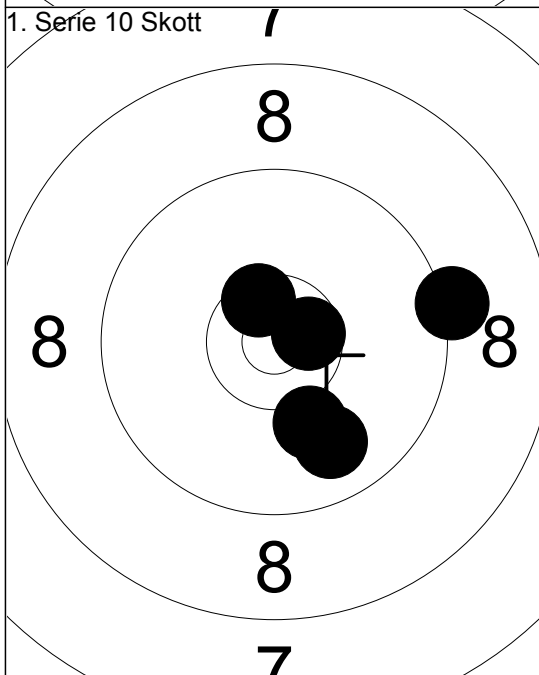

6:	10.1	↘
7:	*10.5	↗
8:	*10.6	↗
9:	9.2	↗
10:	9.9	↘
Serie	48.0	
Total	294.0	

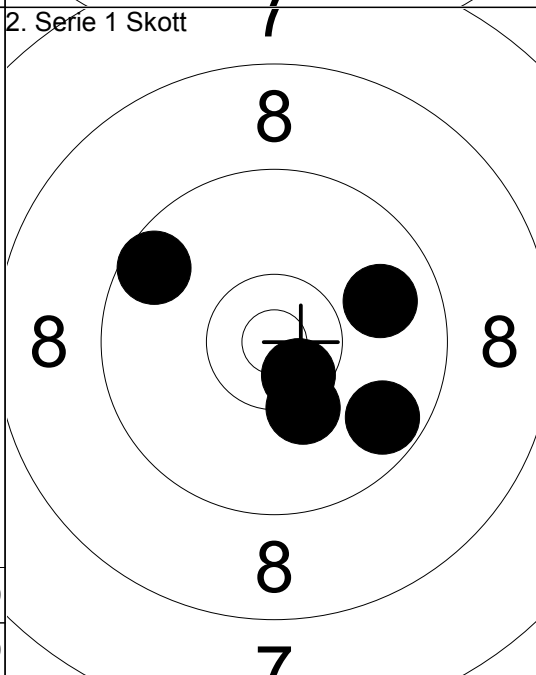

1:	9.9	↗
2:	9.7	↘
3:	9.6	↗
4:	*10.6	↘
5:	10.3	↘
Serie	47.0	
Total	341.0	

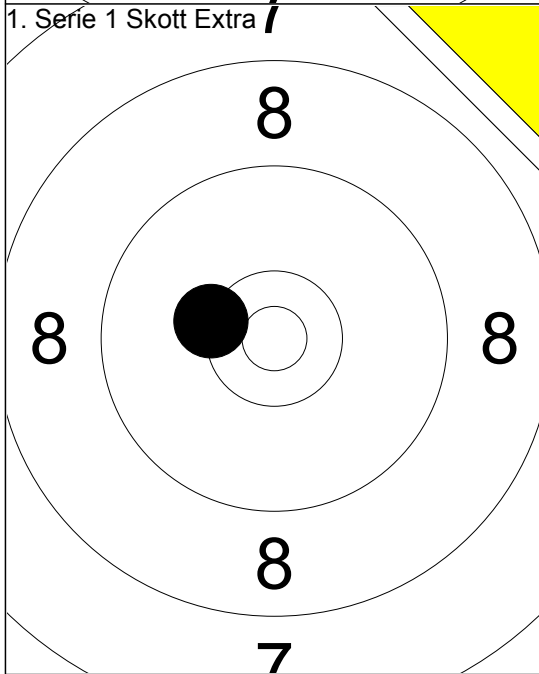

1:	*10.3	←
Serie	10.0	
Total	341.0	

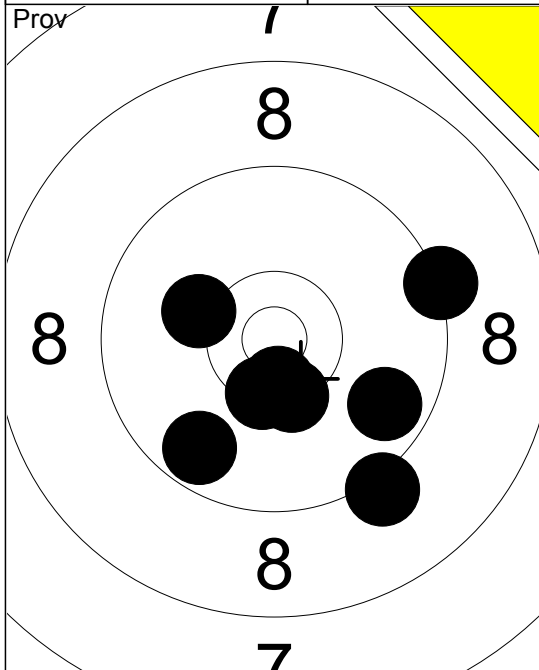

1:	*10.5	↓
2:	9.3	→
3:	10.2	←
4:	9.2	↘
5:	9.7	↘
6:	*10.4	↓
7:	9.7	↘
8:	*10.4	↓
Serie		76.0
Total		195.0

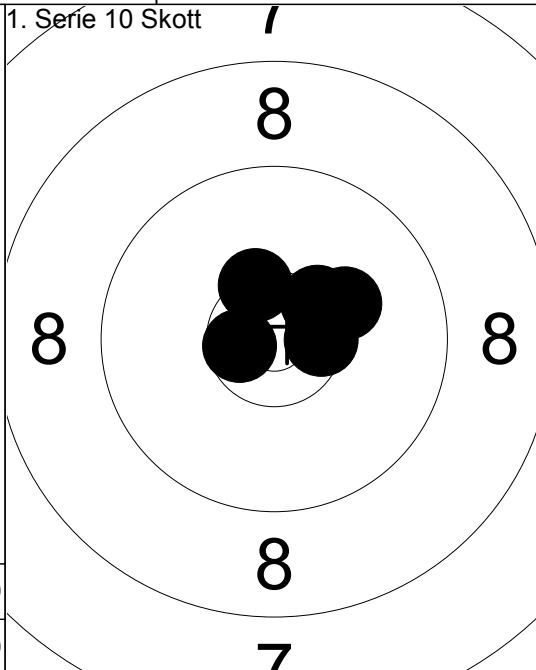

1:	*10.4	↗
2:	*10.6	←
3:	10.2	↗
4:	*10.4	↗
5:	*10.5	→
Serie		50.0
Total		245.0

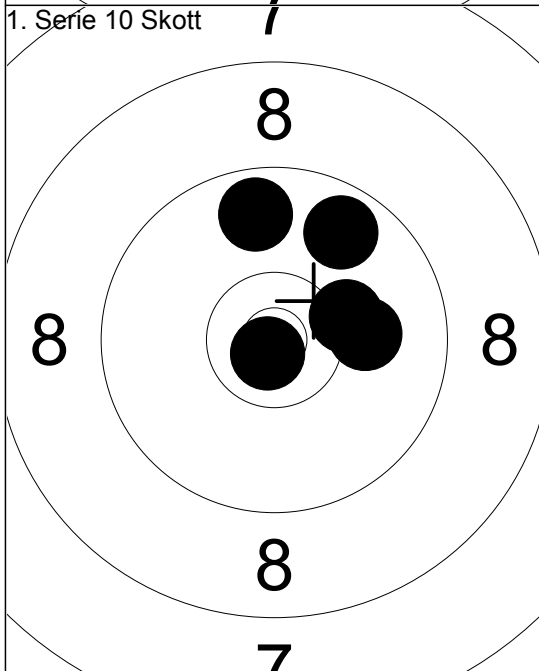

6:	*10.8	↘
7:	10.2	→
8:	9.7	↑
9:	10.1	→
10:	9.8	↗
Serie		48.0
Total		293.0

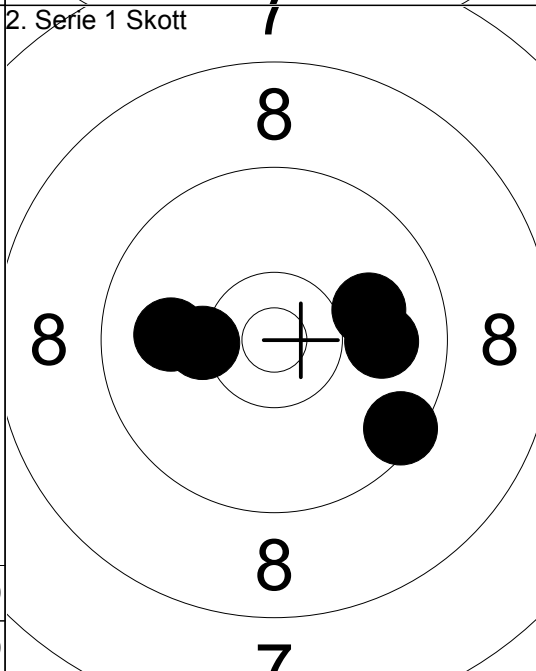

1:	9.5	↘
2:	10.0	←
3:	10.0	→
4:	9.9	→
5:	10.3	←
Serie		48.0
Total		341.0

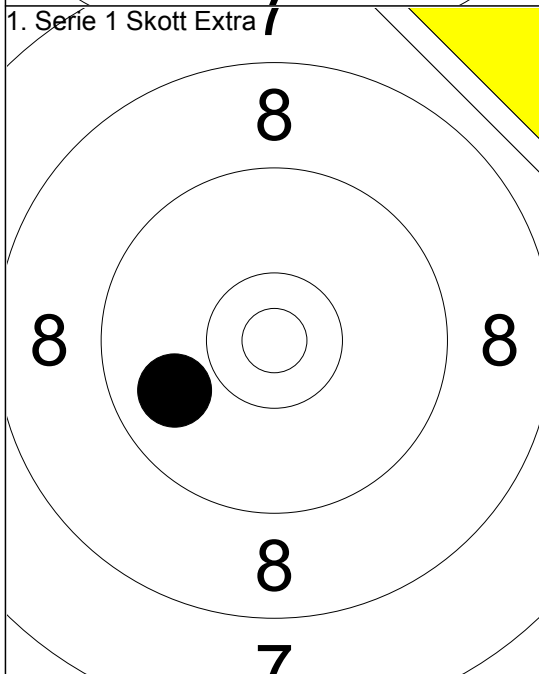

1:	9.9	←
Serie		9.0
Total		341.0

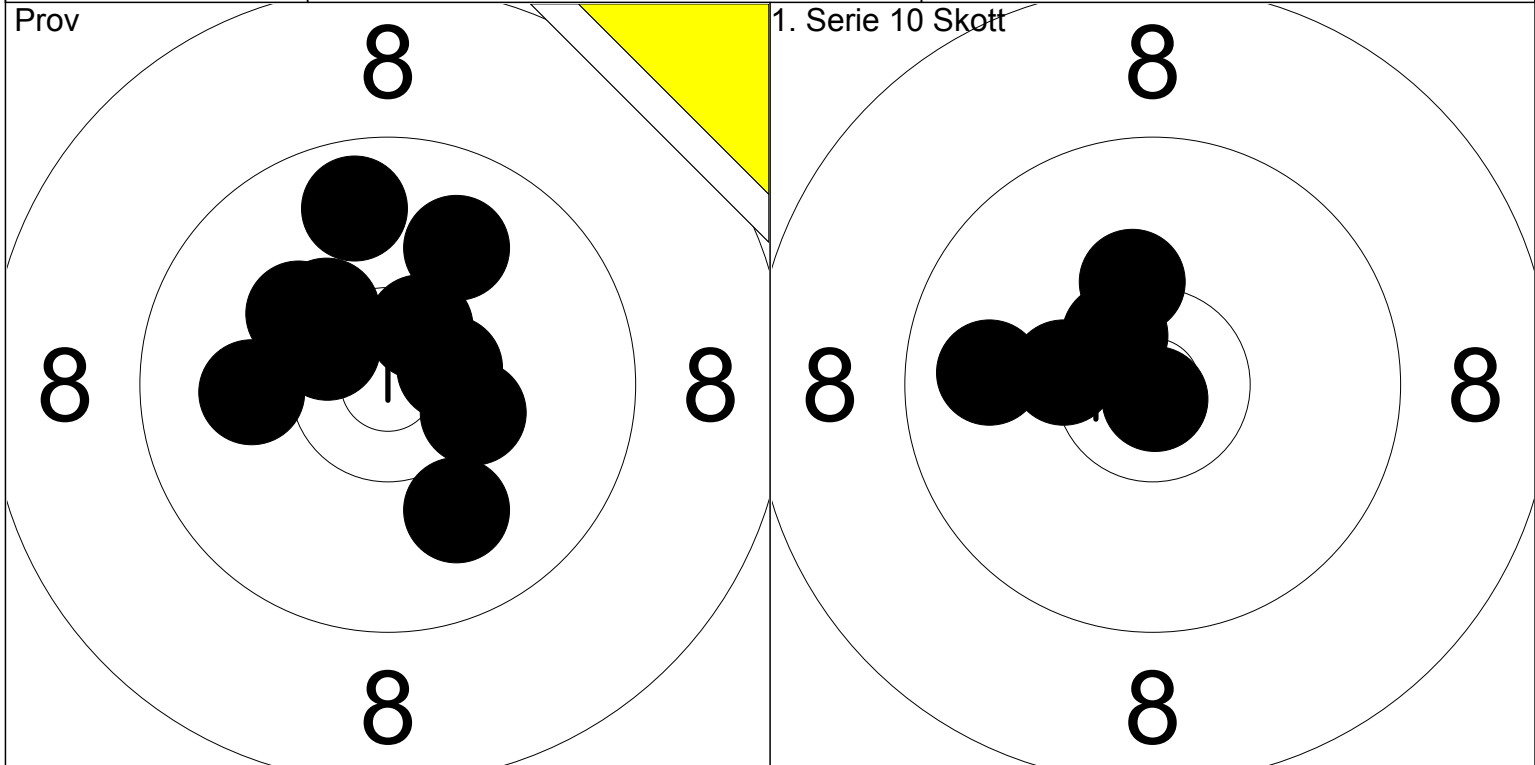

1: 10.2 ↖	6: 10.0 ↘		1: 10.3 ↗		
2: *10.4 →	7: 10.0 ←	Serie	2: *10.4 ←		Serie
3: *10.5 →	8: *10.5 ↗		3: 9.9 ←		
4: *10.5 ↗	9: *10.3 ↗	Total	4: *10.9 ↘		Total
5: 9.9 ↗	10: 9.8 ↗	98.0	5: *10.5 ↖		49.0
		195.0			244.0

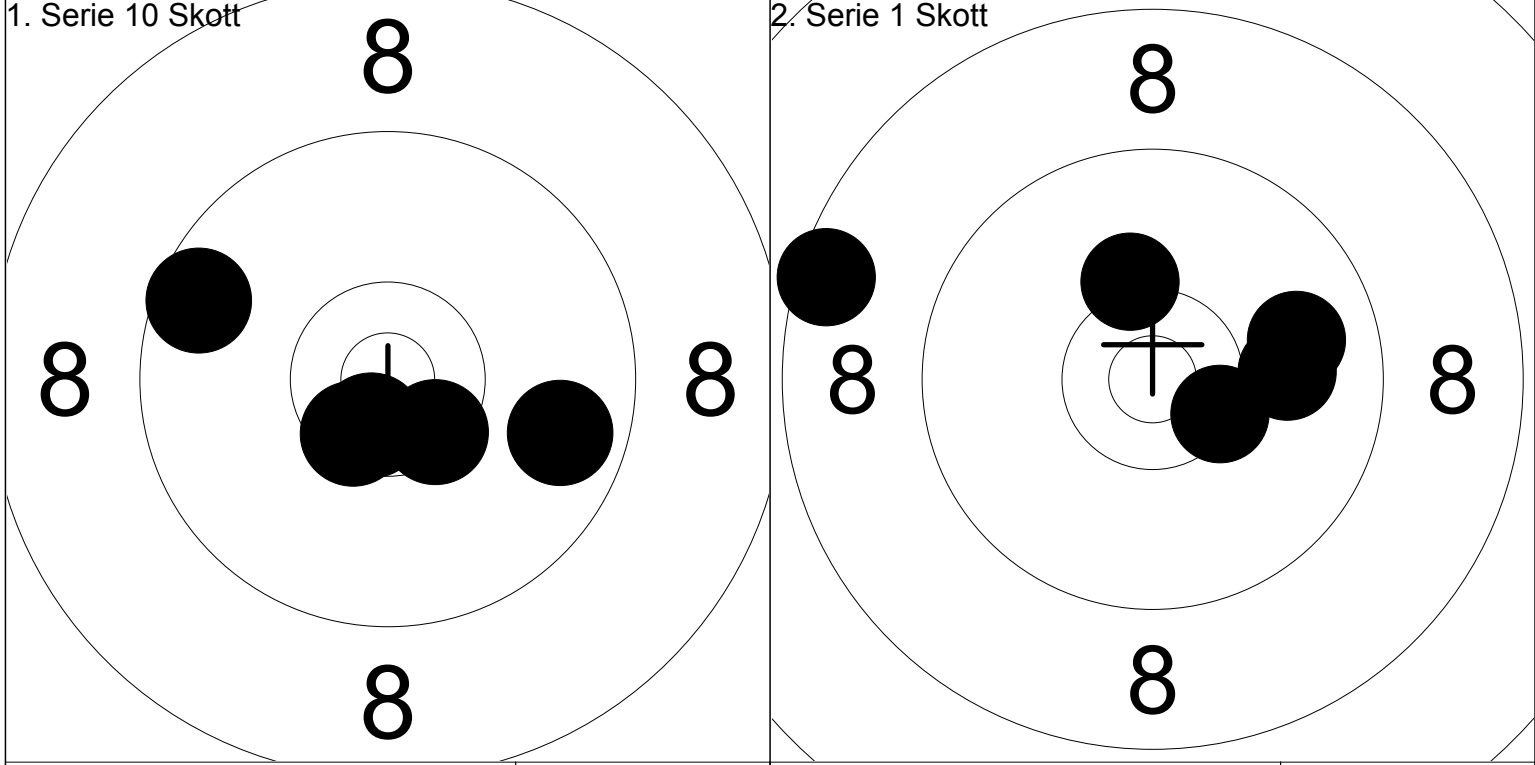

6: 9.7 →			1: 10.0 →		
7: *10.6 ↘		Serie	2: 9.9 →		Serie
8: 9.6 ↖			3: 10.2 ↗		
9: *10.5 ↘		Total	4: *10.4 ↘		Total
10: *10.5 ↘		48.0	5: 8.5 ↖		47.0
		292.0			339.0

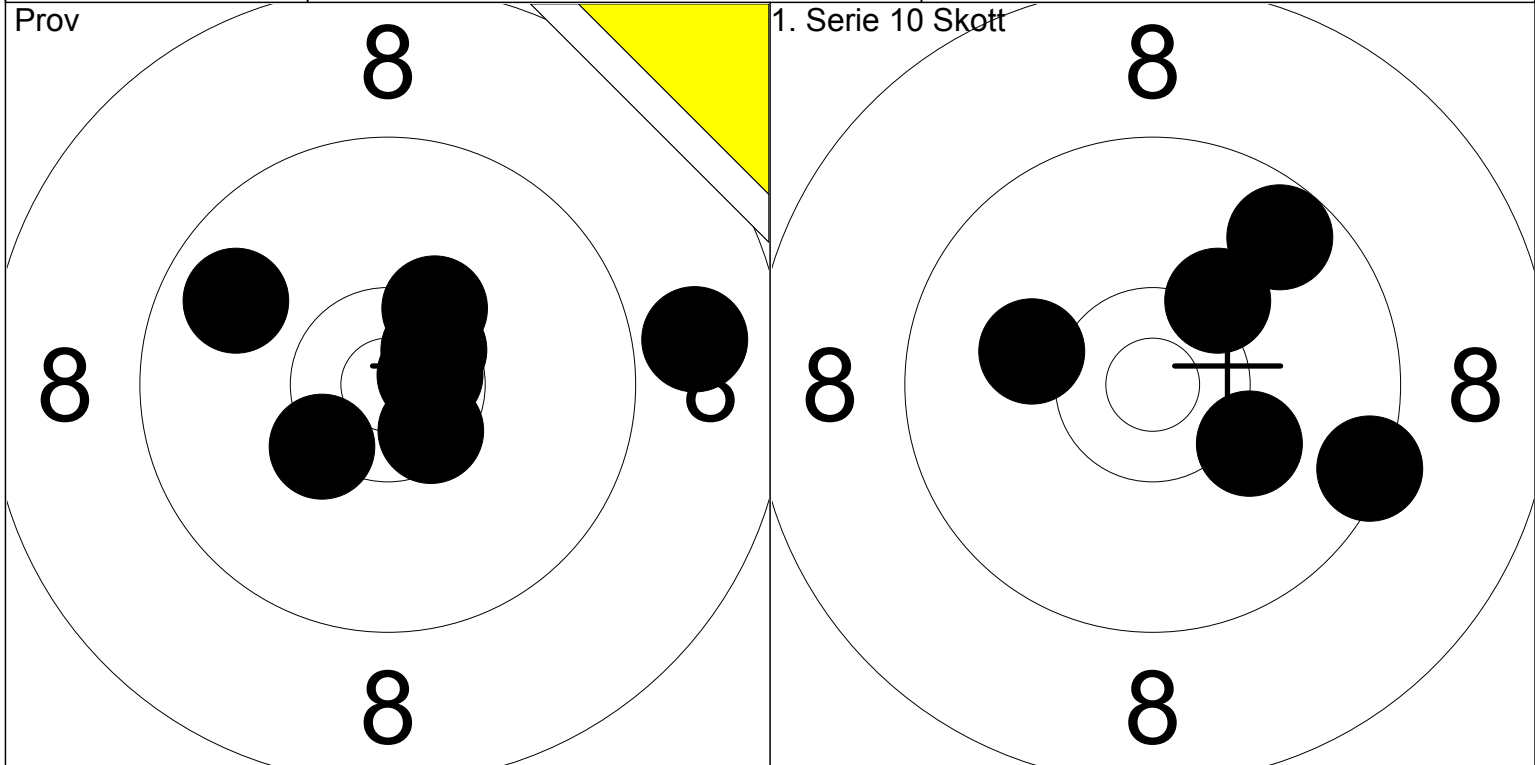

1: *10.6 ↗	7: *10.7 →	Serie 67.0	1: 9.4 →	Serie 48.0
2: *10.5 ↘	8: *10.3 ↙		2: 10.2 ↘	
4: *10.4 ↗		Total 194.0	3: 10.1 ←	
5: 8.9 →			4: 10.2 ↗	Total 242.0
6: 9.8 ↖			5: 9.7 ↗	

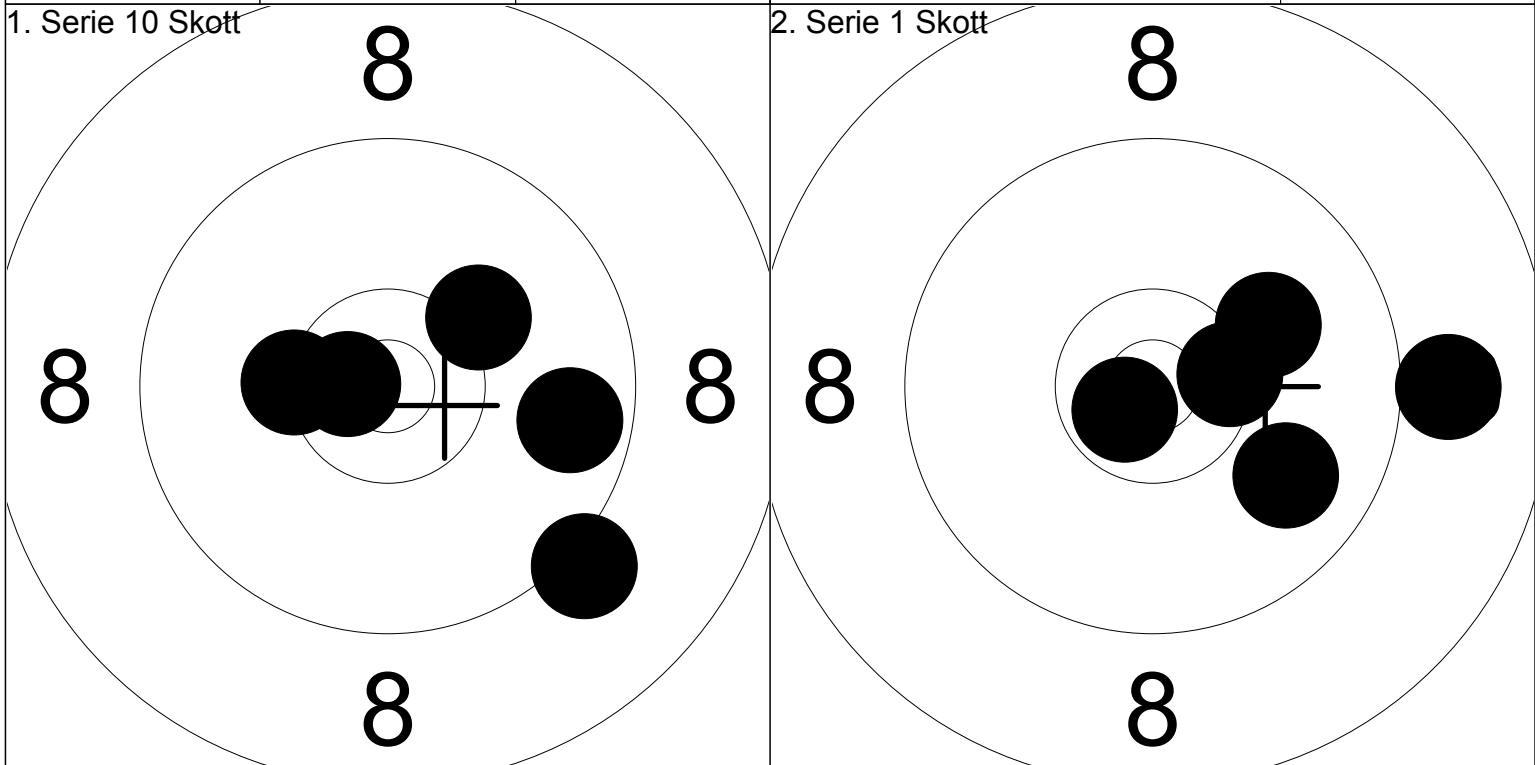

6: 9.2 ↘	Serie 48.0	1: 10.1 ↗	Serie 48.0
7: *10.7 ←		2: 9.9 ↘	
8: *10.3 ←	Total 290.0	3: 9.0 →	Total 338.0
9: 10.2 ↗		4: *10.4 →	
10: 9.7 →		5: *10.7 ↙	

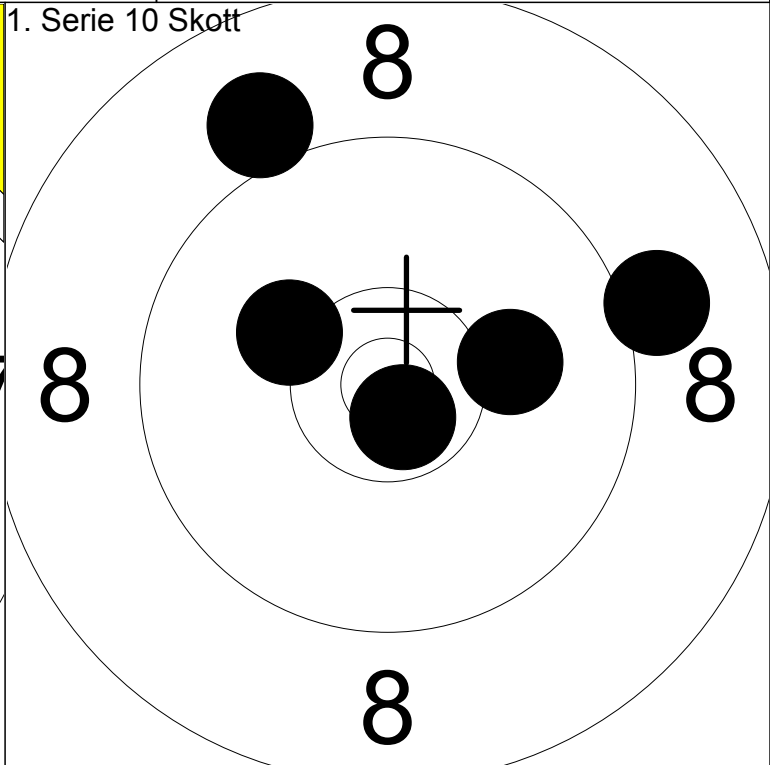
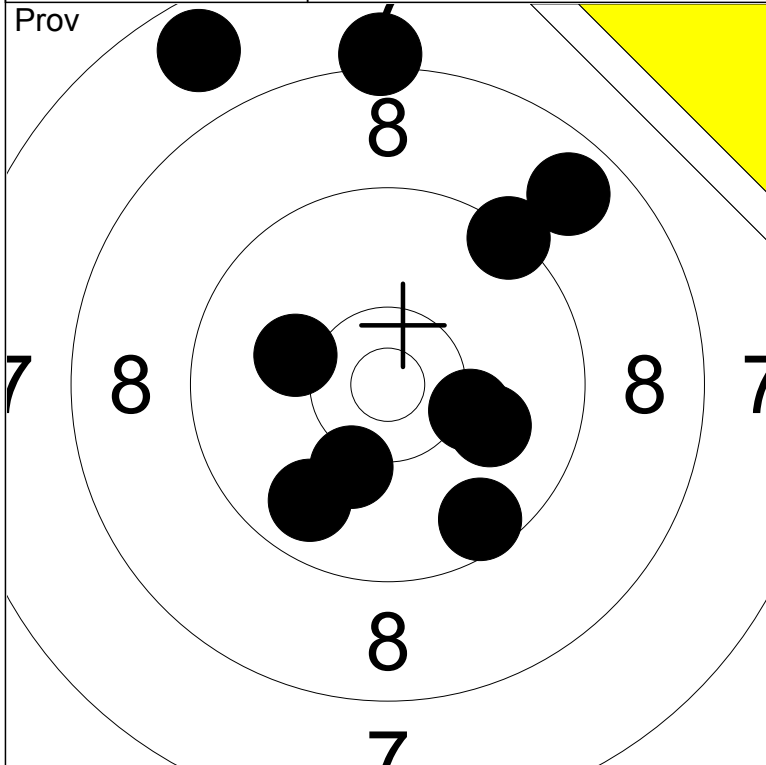

1: 8.2	↑	6: 10.2	↓	Serie	90.0
2: 8.8	↗	7: 9.6	↓	Total	194.0
3: 9.4	↗	8: 9.8	↓		
4: 7.7	↖	9: 10.2	→		
5: 10.1	←	10: 10.0	↓		

1: 10.2	↖	Serie	48.0
2: *10.7	↓	Total	242.0
3: 9.0	↗		
4: 10.1	→		
5: 9.1	→		

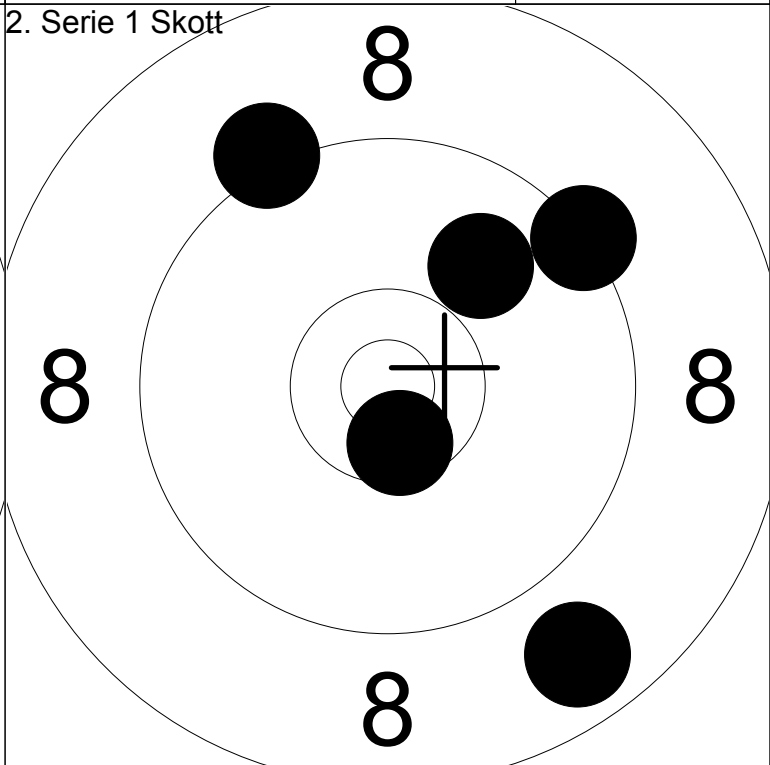
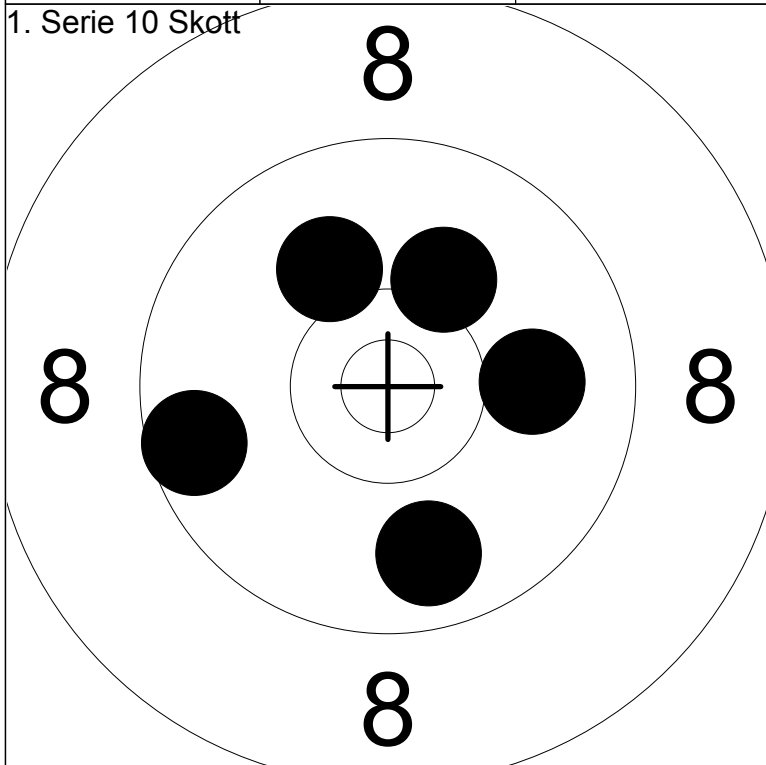

6: 10.1	↗	Serie	48.0
7: 10.1	↖	Total	290.0
8: 10.0	→		
9: 9.6	←		
10: 9.8	↓		

1: 8.8	↓	Serie	45.0
2: *10.6	↓	Total	335.0
3: 9.3	↗		
4: 9.9	↗		
5: 9.2	↖		

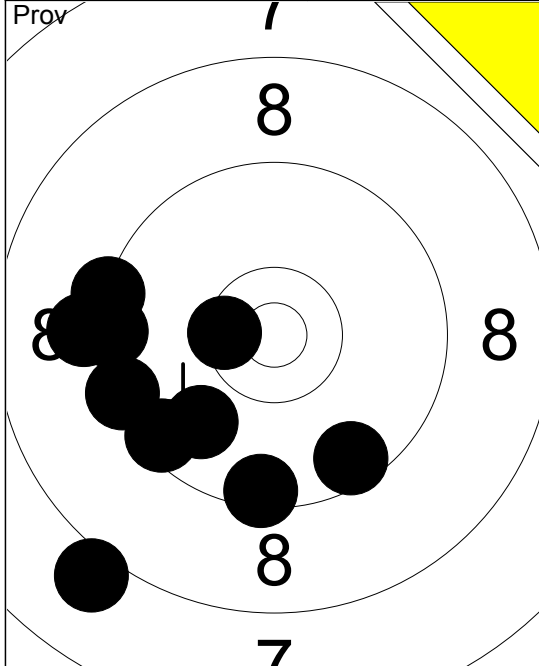

1:	*10.5	←
2:	9.5	↙
3:	8.1	↘
4:	9.4	←
5:	9.4	←
6:	9.3	←
7:	9.6	↘
8:	9.5	↘
9:	9.9	↘
10:	9.1	←
Serie		90.0
Total		193.0

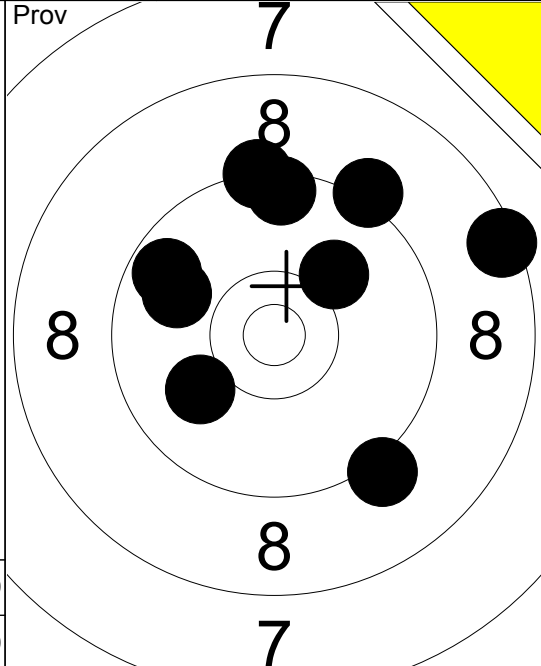

11:	9.2	↘
12:	9.9	←
13:	9.5	↑
14:	9.2	↗
15:	9.7	←
16:	10.1	↗
17:	8.5	↗
18:	9.3	↑
19:	10.0	↙
Serie		82.0
Total		193.0

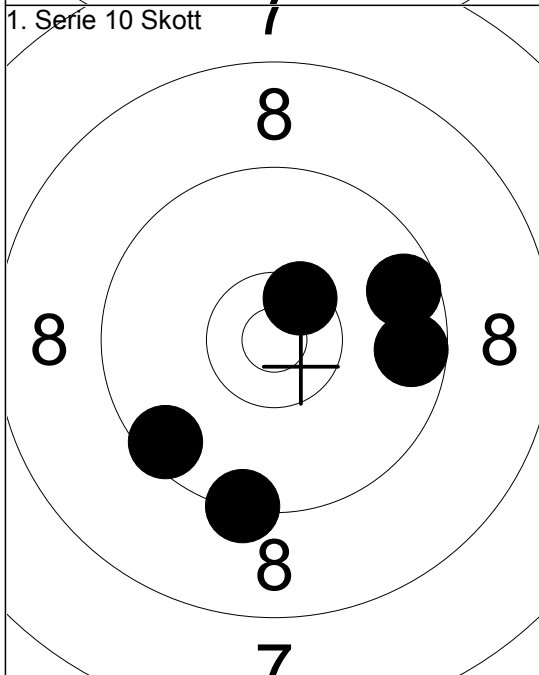

1:	9.5	↙
2:	9.3	↘
3:	*10.5	↗
4:	9.6	→
5:	9.6	→
Serie		46.0
Total		239.0

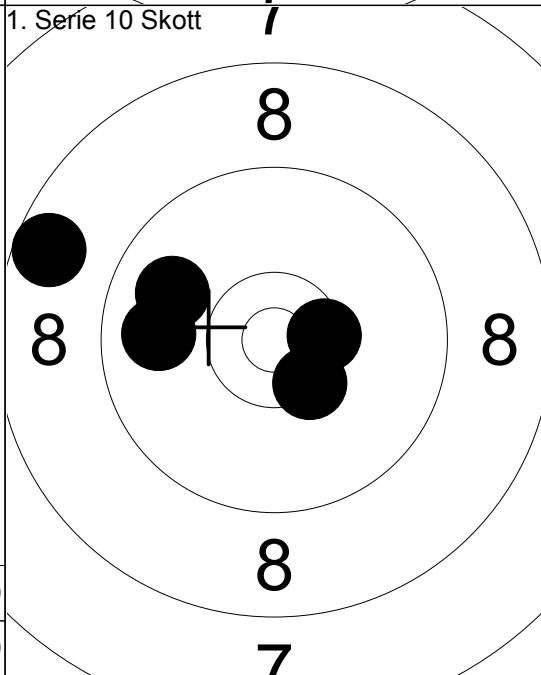

6:	*10.5	→
7:	9.9	←
8:	8.6	←
9:	*10.4	↘
10:	9.8	←
Serie		46.0
Total		285.0

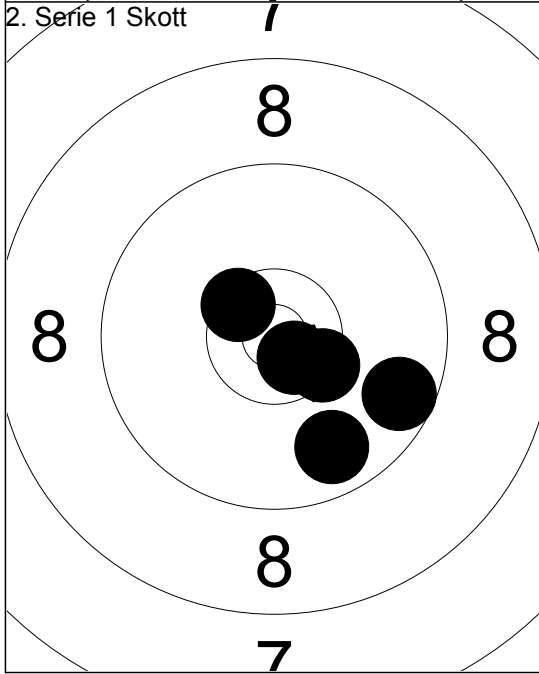

1:	*10.5	↗
2:	*10.7	↘
3:	9.8	↘
4:	9.6	↘
5:	*10.4	↘
Serie		48.0
Total		333.0

Skjutlag 6 Tavlav 9

Stefan Lundqvist

50m

Ununge

6, Sen-L St

18.07.2015

Tavelträffen KH 2015

Ramselefors SKF

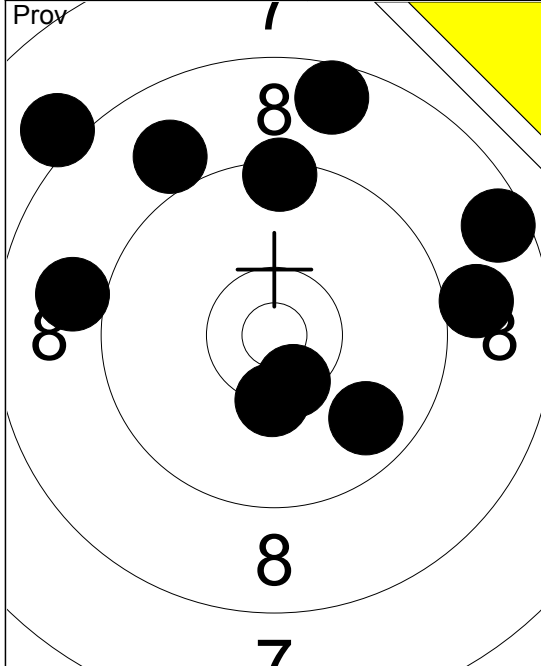

1:	9.0	→
2:	9.4	↑
3:	8.1	↖
4:	8.6	↗
5:	9.0	←
6:	8.6	↑
7:	9.0	↗
8:	*10.3	↓
9:	9.8	↘
10:	*10.5	↓
Serie		89.0
Total		193.0

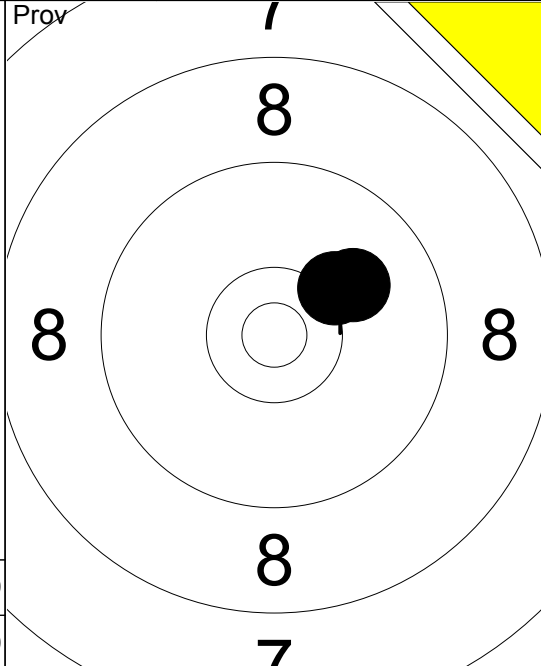

11:	10.2	↗
12:	10.1	↗
Serie		20.0
Total		193.0

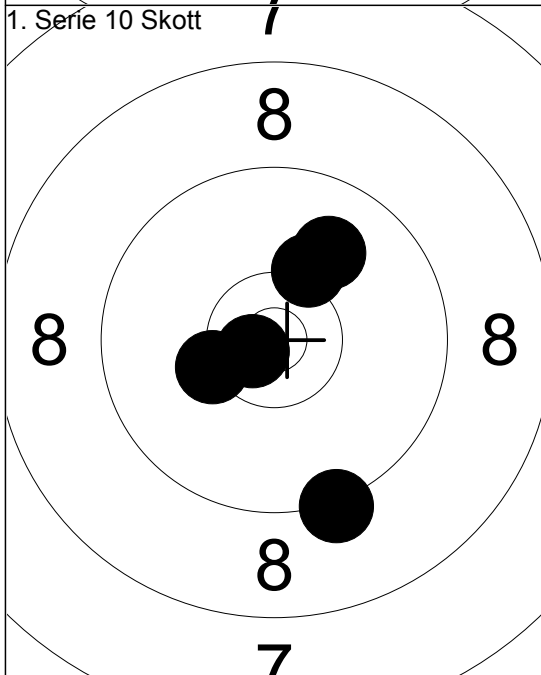

1:	*10.3	←
2:	9.3	↓
3:	*10.7	←
4:	10.0	↗
5:	10.2	↗
Serie		49.0
Total		242.0

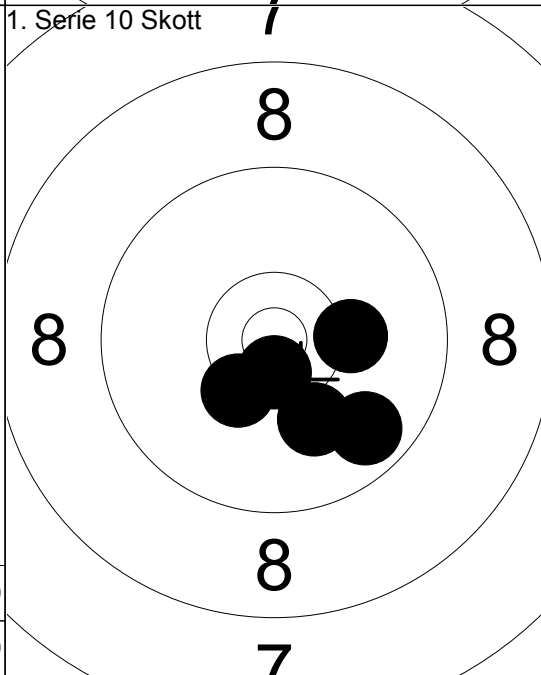

6:	10.1	↓
7:	*10.6	↓
8:	9.7	↘
9:	*10.4	↘
10:	10.2	→
Serie		49.0
Total		291.0

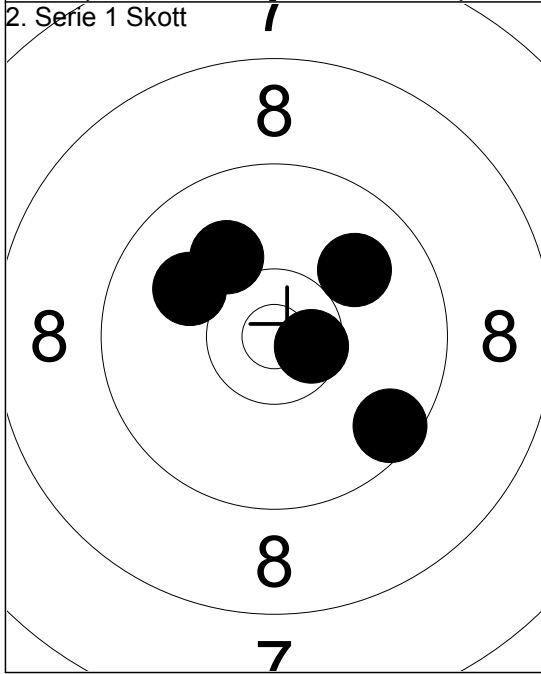

1:	9.6	↘
2:	10.0	↗
3:	10.0	↖
4:	*10.6	→
5:	10.1	↗
Serie		49.0
Total		340.0

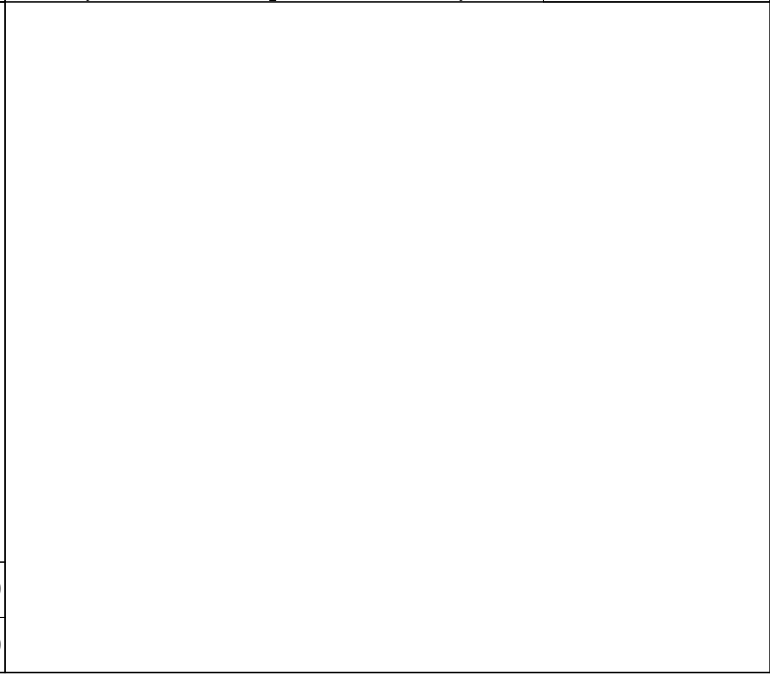

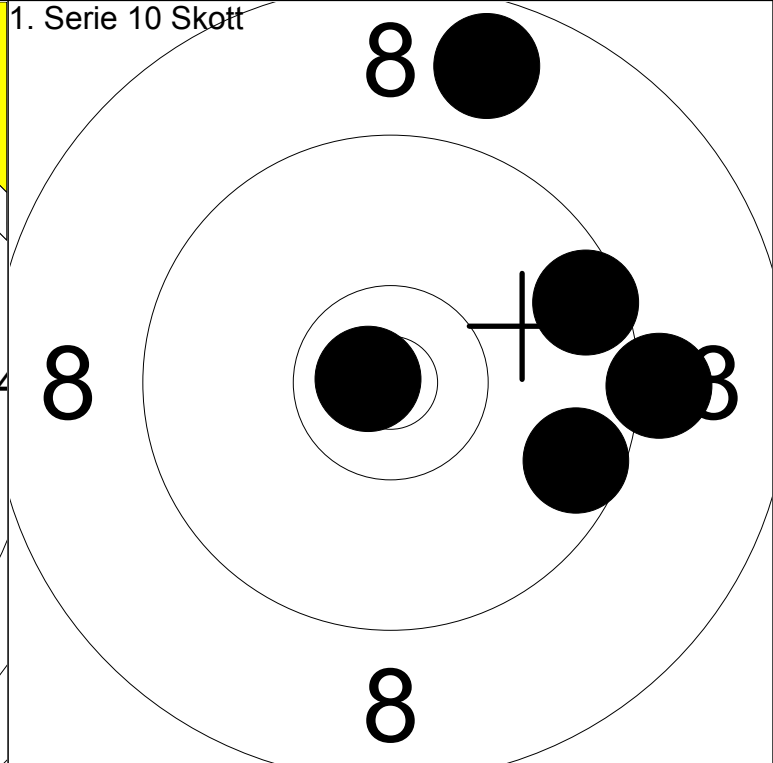
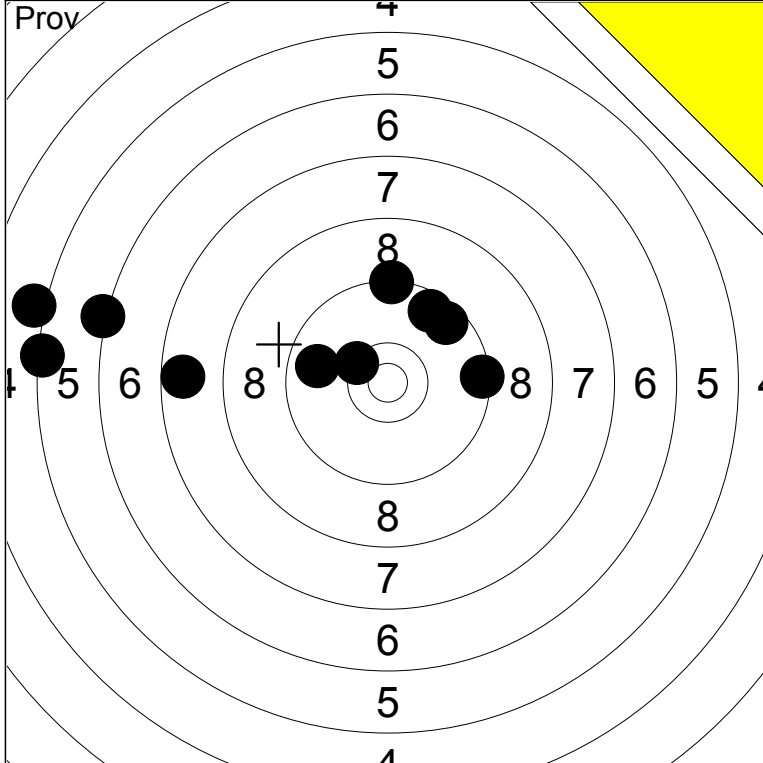

1: 7.6 ←	6: *10.4 ↖	Serie	78.0
2: 5.1 ←	7: 9.8 ←		
3: 5.4 ←	8: 9.6 ↗	Total	193.0
4: 6.2 ←	9: 9.6 ↗		
5: 9.3 ↑	10: 9.4 →		

1: 8.7 ↗	Serie	45.0
2: *10.8 ←		
3: 9.6 →	Total	238.0
4: 9.2 →		
5: 9.5 →		

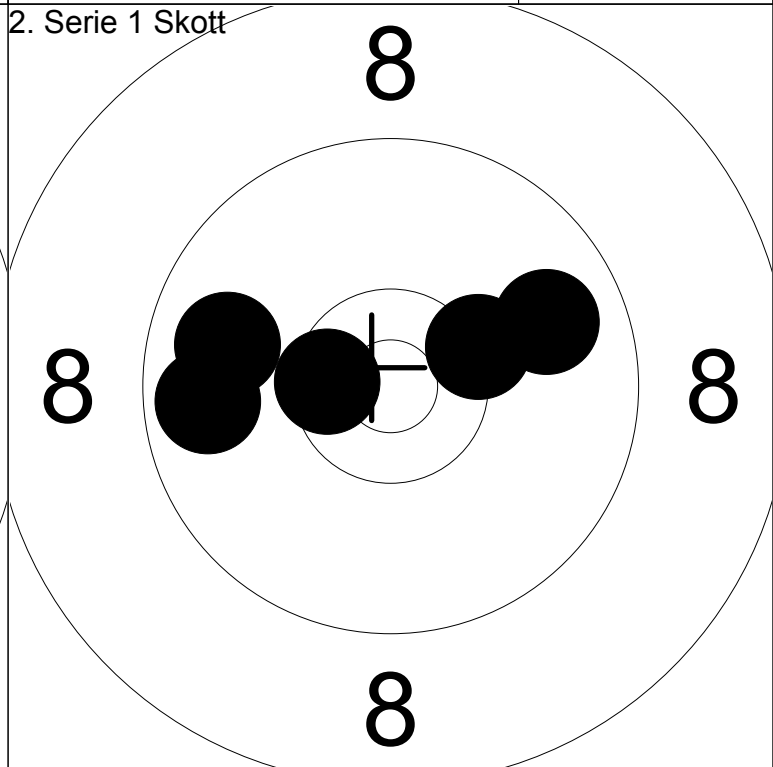
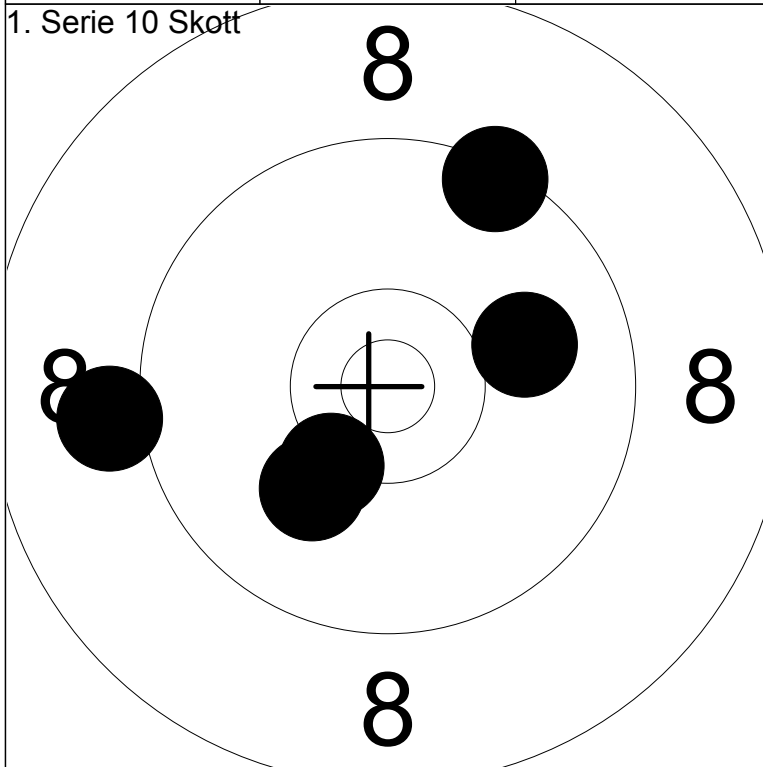

6: 9.1 ←	Serie	48.0
7: 10.0 →		
8: 10.1 ↘	Total	286.0
9: *10.3 ↘		
10: 9.4 ↗		

1: 9.8 →	Serie	47.0
2: 9.7 ←		
3: *10.5 ←	Total	333.0
4: 9.8 ←		
5: *10.3 →		

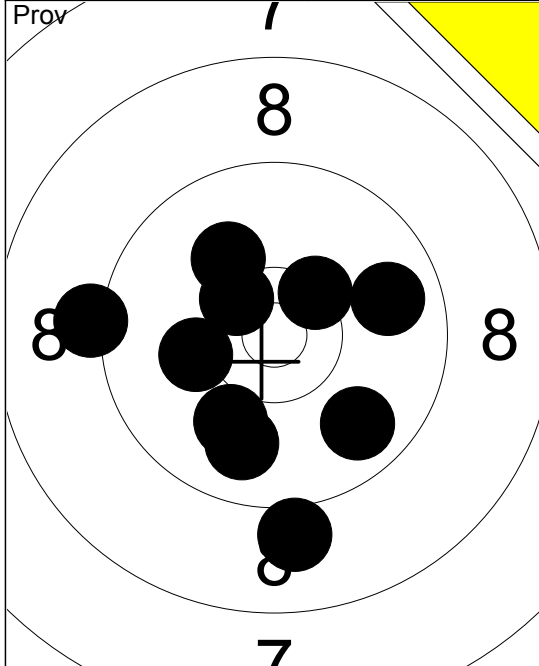

1:	9.2	←
2:	10.0	↓
3:	10.2	←
4:	10.1	↗
5:	9.8	→
6:	9.9	↓
7:	*10.4	↗
8:	9.8	↓
9:	*10.4	↗
10:	9.0	↓
Serie		95.0
Total		193.0

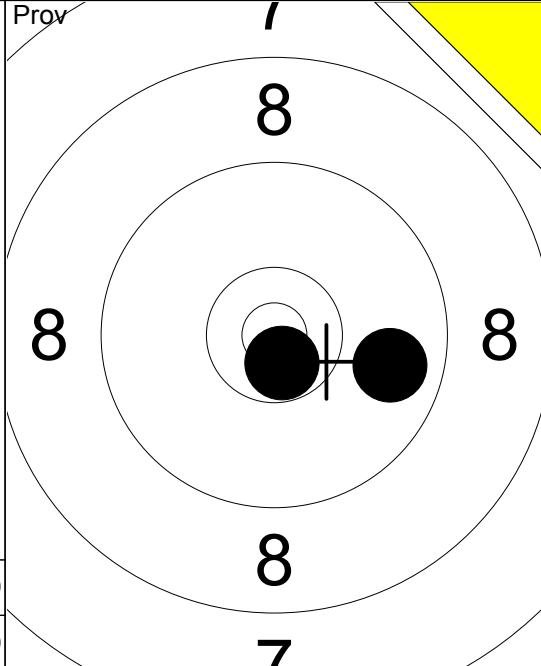

11:	9.8	→
12:	*10.7	↓
Serie		19.0
Total		193.0

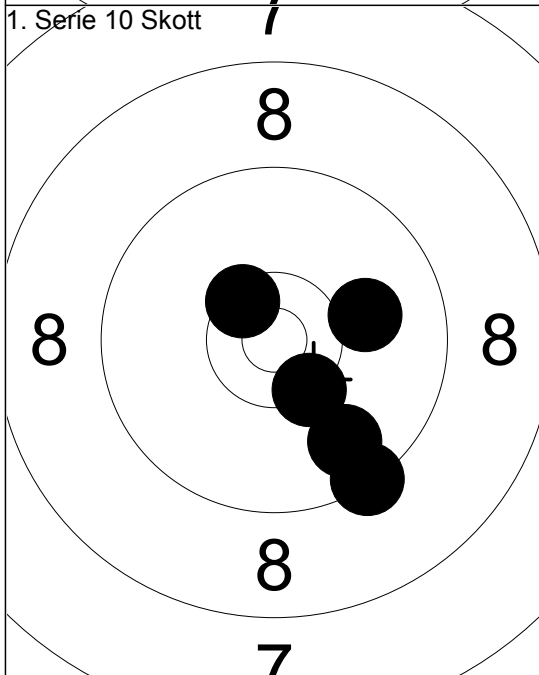

1:	10.1	→
2:	*10.4	↓
3:	*10.5	↗
4:	9.8	↓
5:	9.4	↓
Serie		48.0
Total		241.0

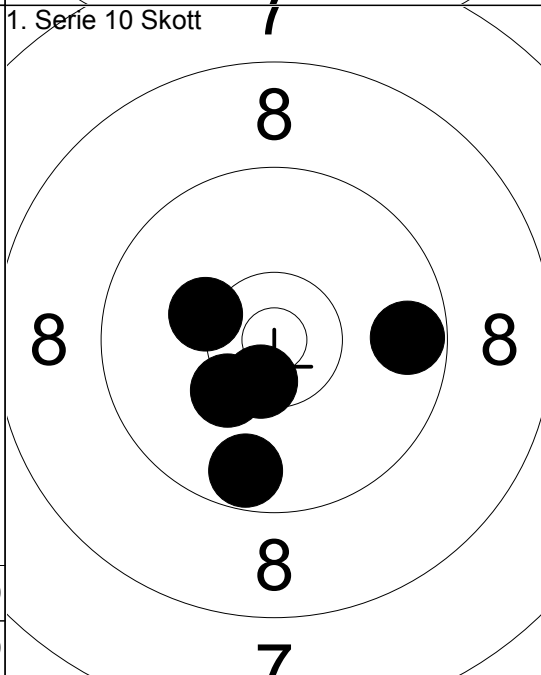

6:	*10.5	↓
7:	9.7	→
8:	9.7	↓
9:	10.3	←
10:	*10.3	↙
Serie		48.0
Total		289.0

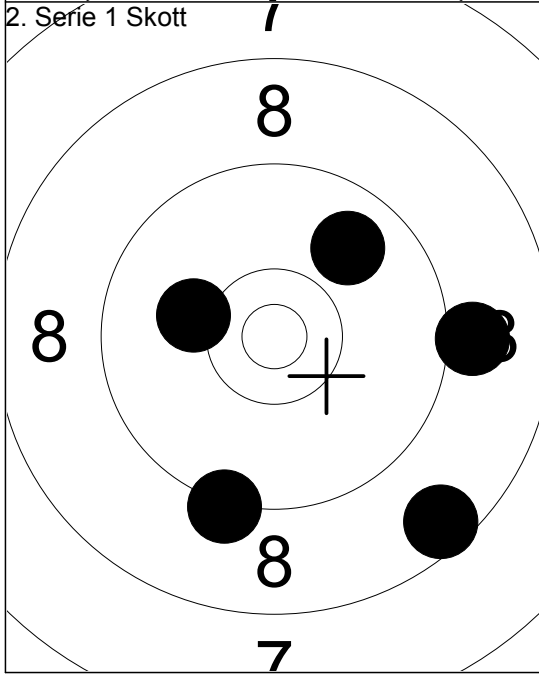

1:	9.1	→
2:	8.6	↓
3:	9.3	↓
4:	10.2	←
5:	9.9	↗
Serie		45.0
Total		334.0

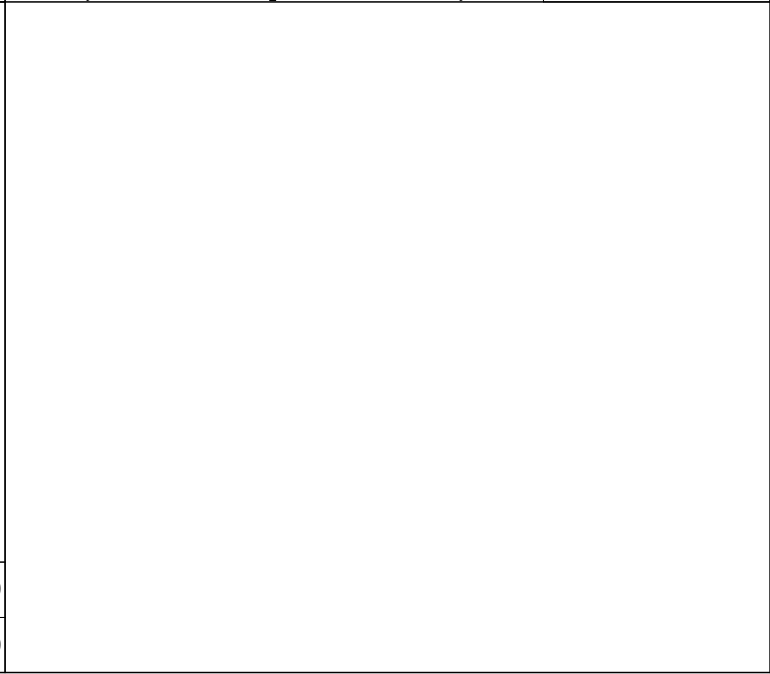

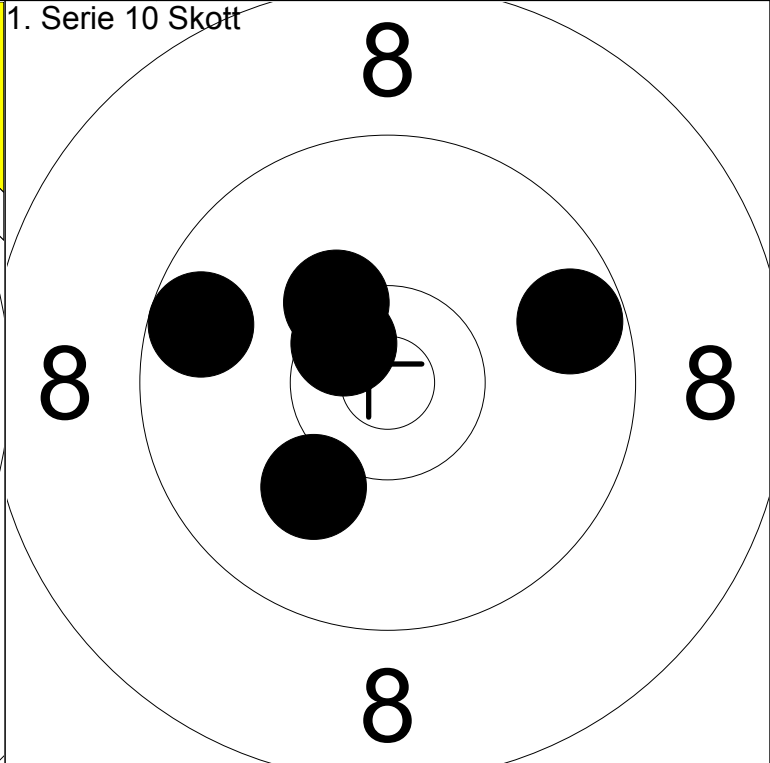
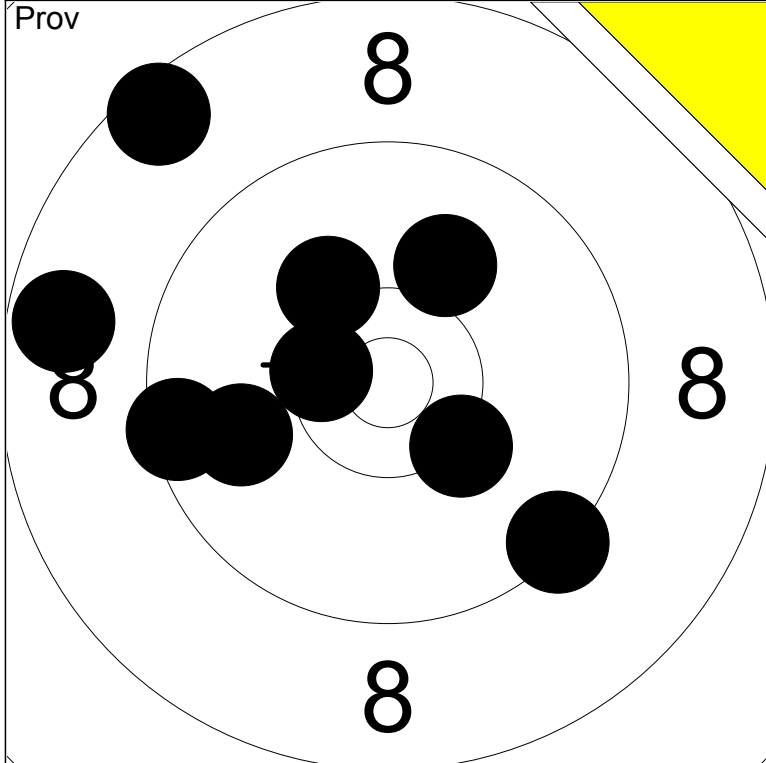

1: 8.5 ↗	6: *10.5 ←	Serie	83.0
2: 8.7 ←	7: 9.9 ←		
3: 10.2 ↗	8: 10.1 ↗	Total	192.0
4: 9.4 ↘	9: 10.3 ↘		
5: 9.5 ←			

1: *10.3 ↗	Serie	48.0
2: 9.7 ←		
3: *10.6 ↗	Total	240.0
4: 10.1 ↘		
5: 9.7 →		

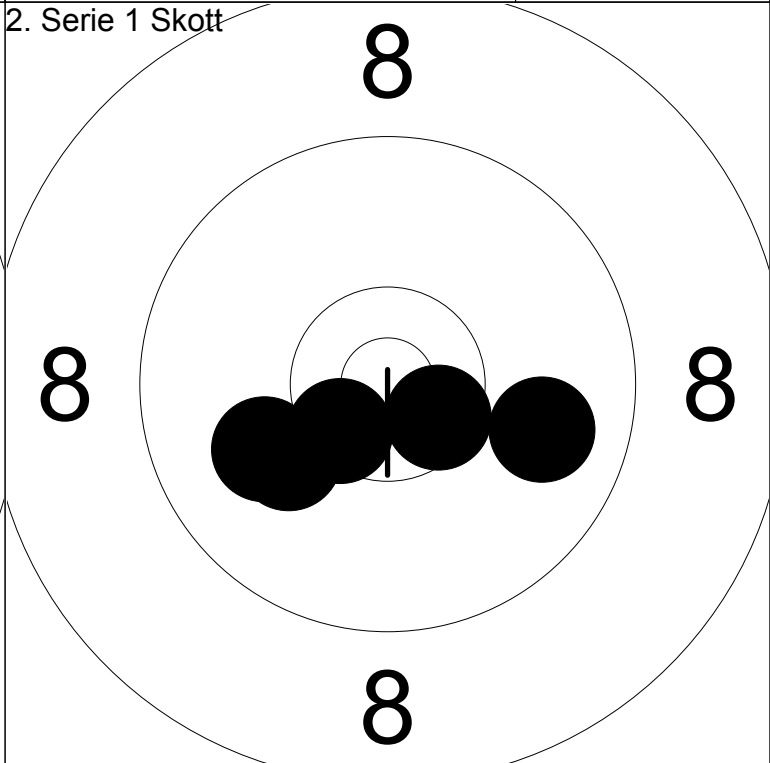
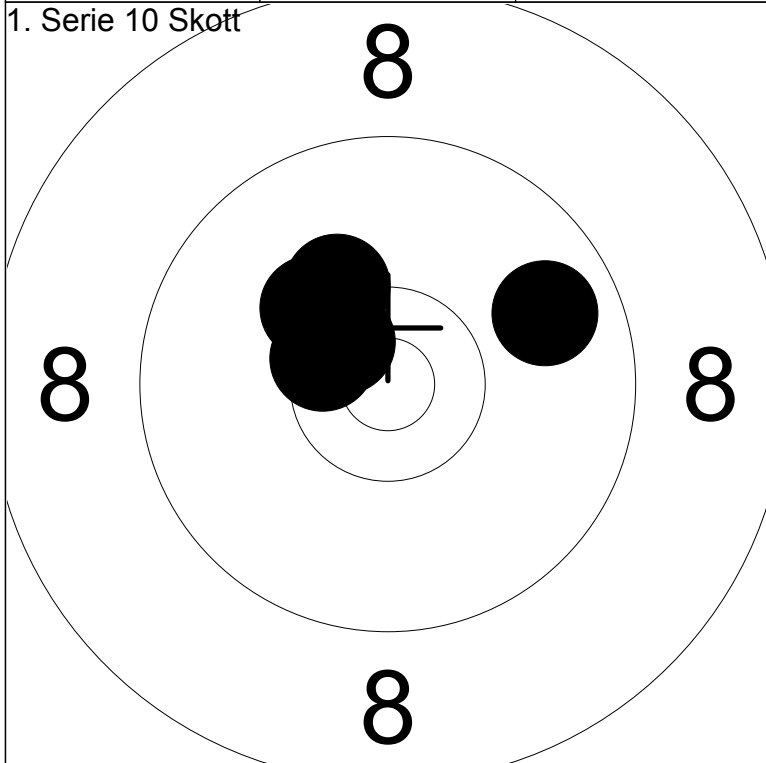

6: 9.8 ↗	Serie	49.0
7: 10.2 ↗		
8: *10.5 ↗	Total	289.0
9: 10.2 ↗		
10: *10.5 ↗		

1: *10.5 ↘	Serie	49.0
2: 10.0 ←		
3: 9.9 →	Total	338.0
4: *10.5 ↘		
5: 10.1 ↘		

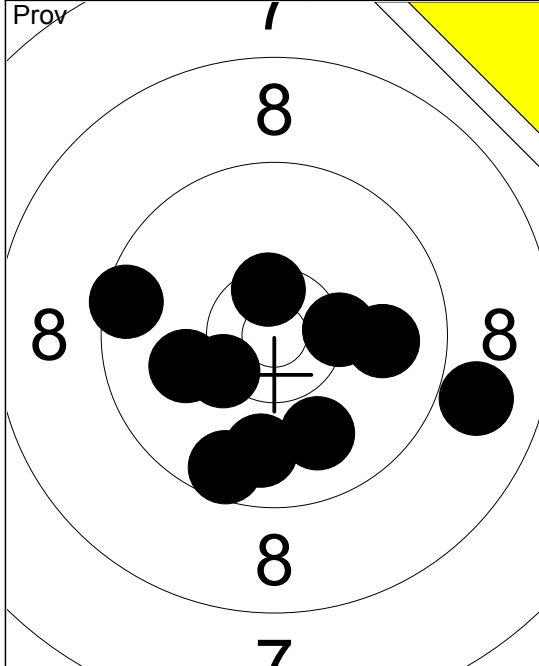

1:	8.9	→
2:	*10.3	↙
3:	9.9	↘
4:	9.9	→
5:	10.1	↙
6:	9.6	↘
7:	9.5	↙
8:	9.8	↘
9:	*10.3	→
10:	*10.5	↑
Serie		93.0
Total		192.0

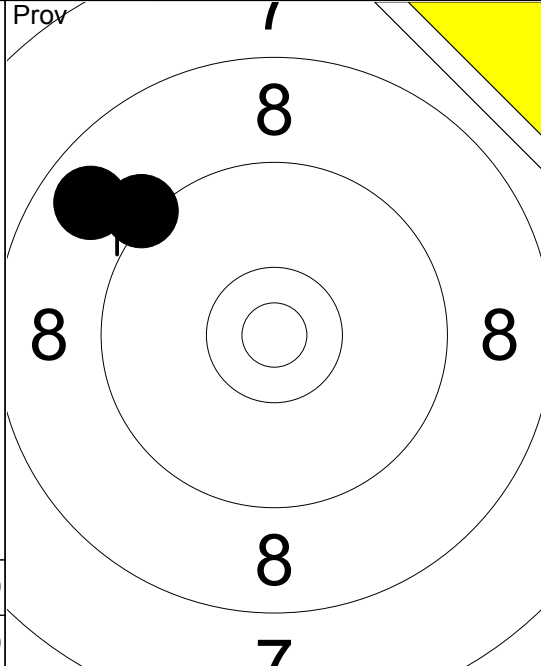

11:	9.2	↖
12:	8.8	↖
Serie		17.0
Total		192.0

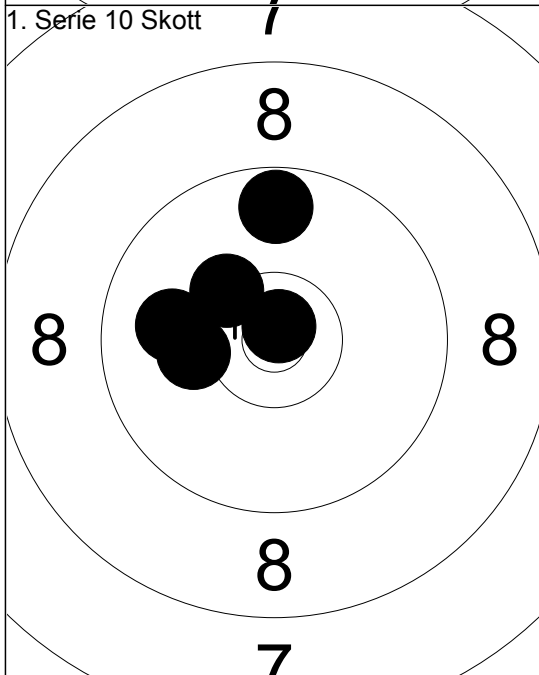

1:	*10.8	↖
2:	*10.3	↖
3:	10.0	↙
4:	9.7	↑
5:	10.2	↙
Serie		49.0
Total		241.0

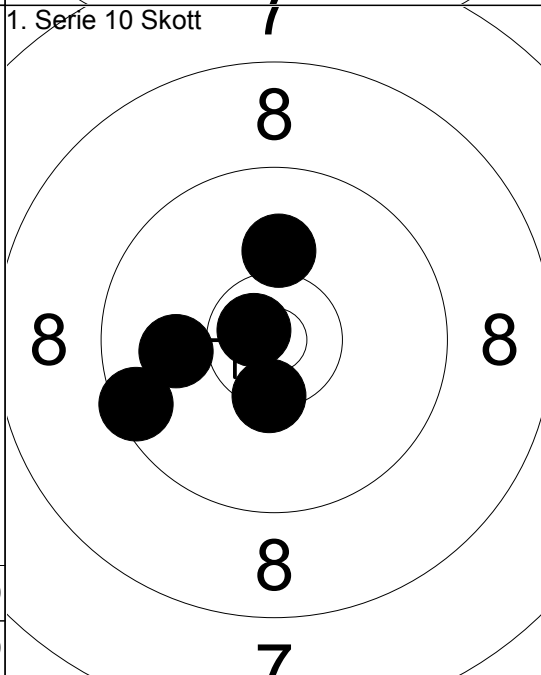

6:	*10.7	↖
7:	9.5	↙
8:	10.0	↙
9:	*10.4	↘
10:	10.1	↑
Serie		49.0
Total		290.0

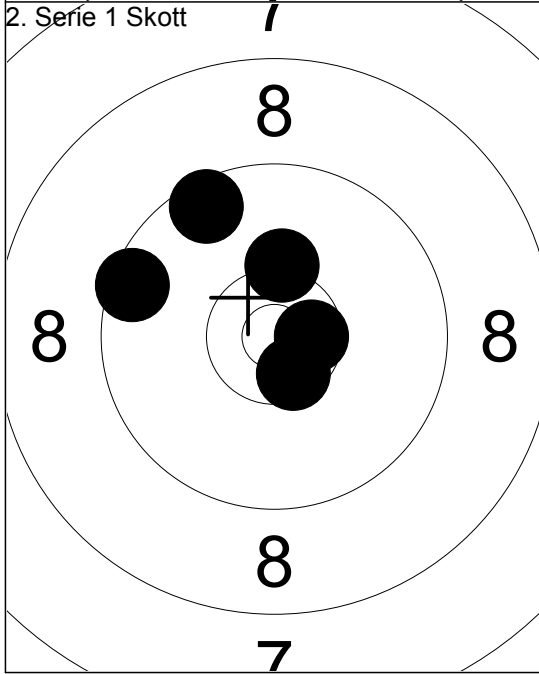

1:	*10.6	↘
2:	10.3	↑
3:	9.5	↙
4:	*10.6	→
5:	9.6	↖
Serie		48.0
Total		338.0

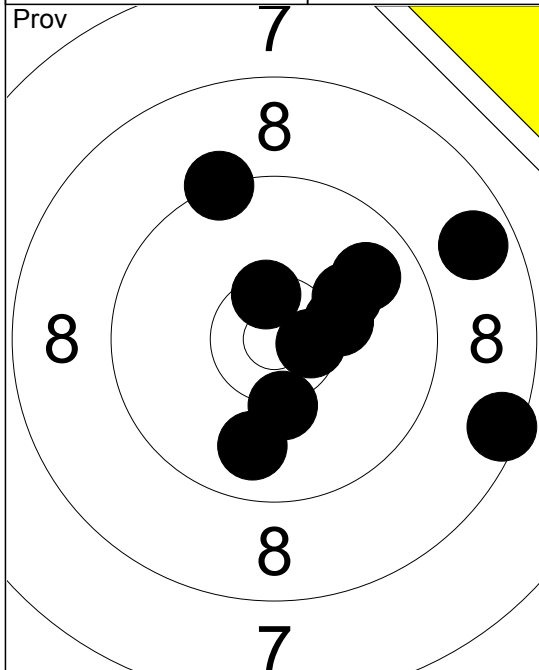

1:	9.8	↗
2:	10.3	→
3:	8.5	→
4:	*10.5	↑
5:	10.1	↗
6:	8.7	↗
7:	*10.6	→
8:	10.3	↓
9:	9.3	↑
10:	9.8	↓
Serie	93.0	
Total	192.0	

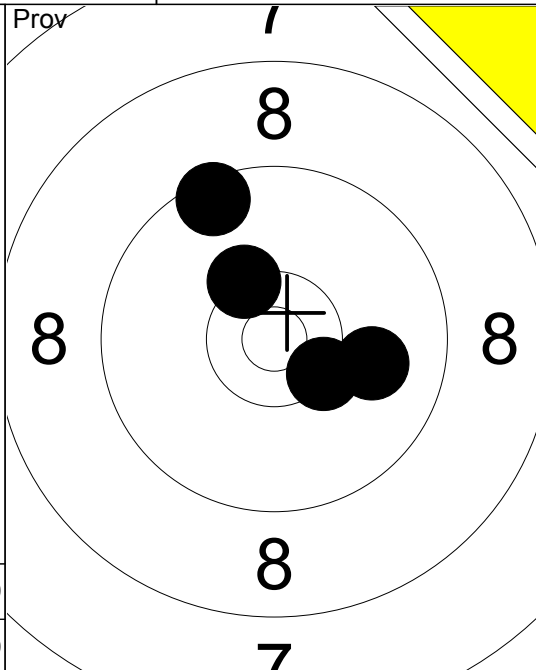

11:	*10.3	↗
12:	9.5	↑
13:	*10.4	↘
14:	10.0	→
Serie	39.0	
Total	192.0	

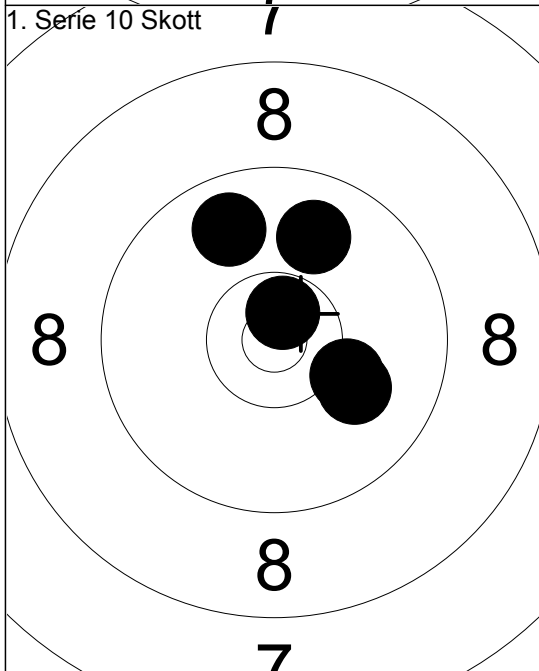

1:	9.8	↑
2:	10.1	↘
3:	*10.7	↑
4:	10.2	↘
5:	9.9	↑
Serie	48.0	
Total	240.0	

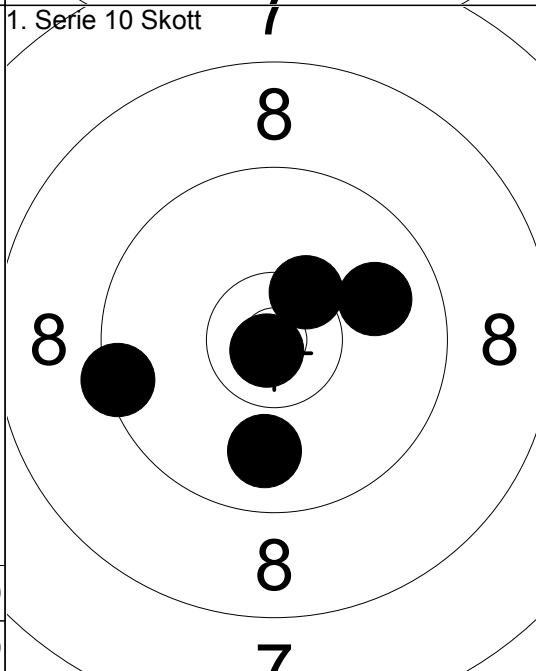

6:	*10.8	↘
7:	9.4	←
8:	9.9	→
9:	9.9	↓
10:	*10.4	↗
Serie	47.0	
Total	287.0	

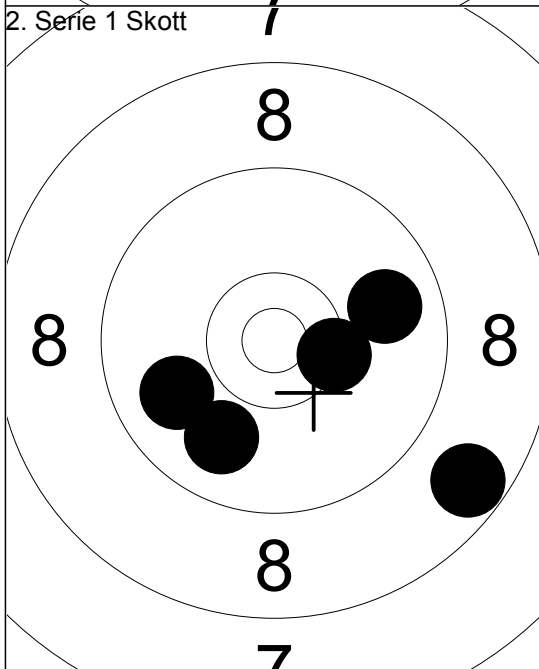

1:	8.7	↘
2:	*10.4	→
3:	9.9	→
4:	9.9	←
5:	9.9	↘
Serie	45.0	
Total	332.0	

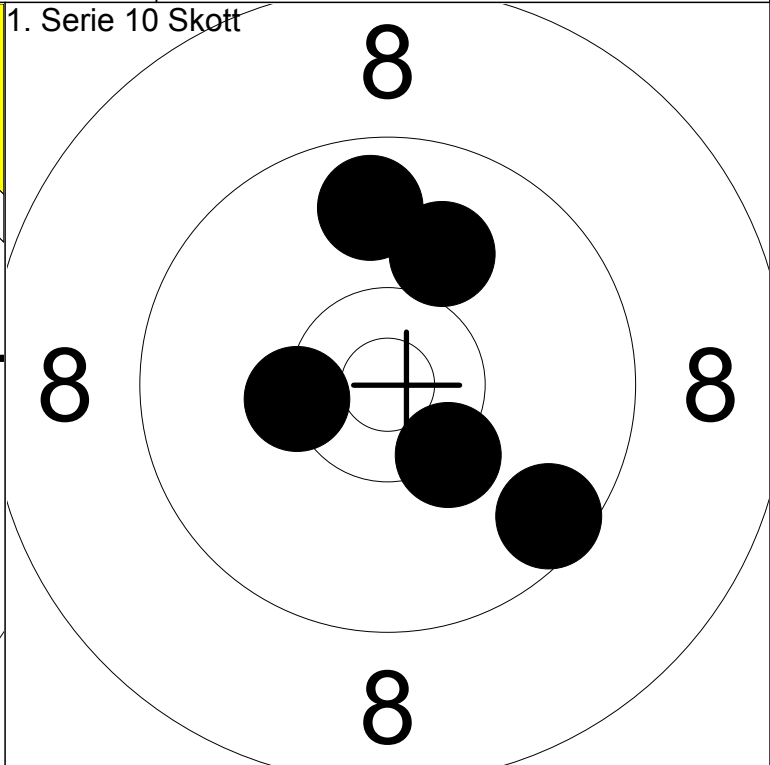
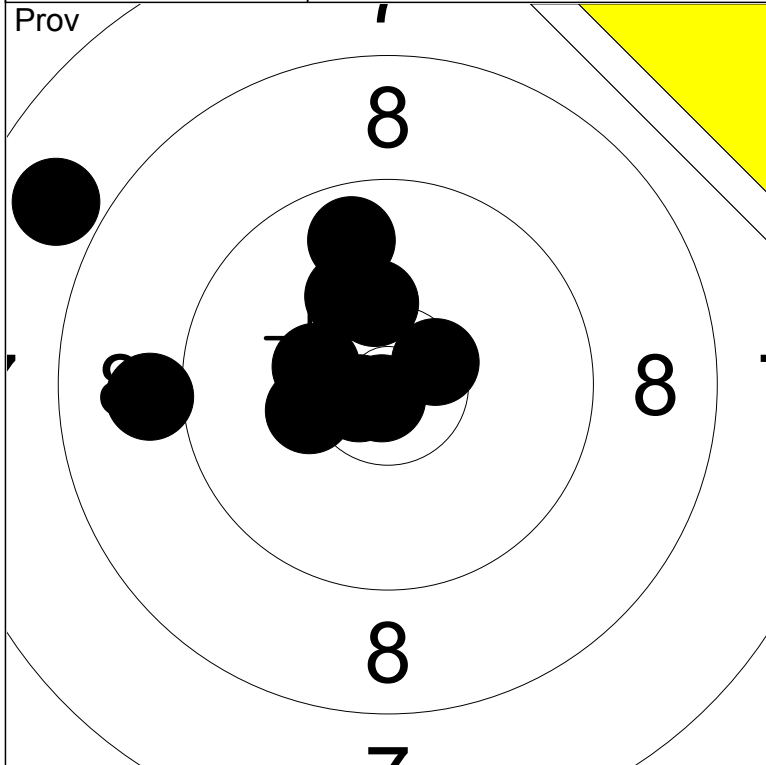

1: *10.4 ←	6: *10.7 ←	Serie	95.0
2: 9.0 ←	7: 10.3 ←		
3: 7.9 ↖	8: 10.2 ↗	Total	191.0
4: *10.8 ↘	9: 10.3 ↗		
5: 9.8 ↗	10: *10.5 ↗		

1: 9.8 ↗	Serie	48.0
2: *10.3 ←		
3: 10.0 ↗	Total	239.0
4: *10.3 ↘		
5: 9.6 ↘		

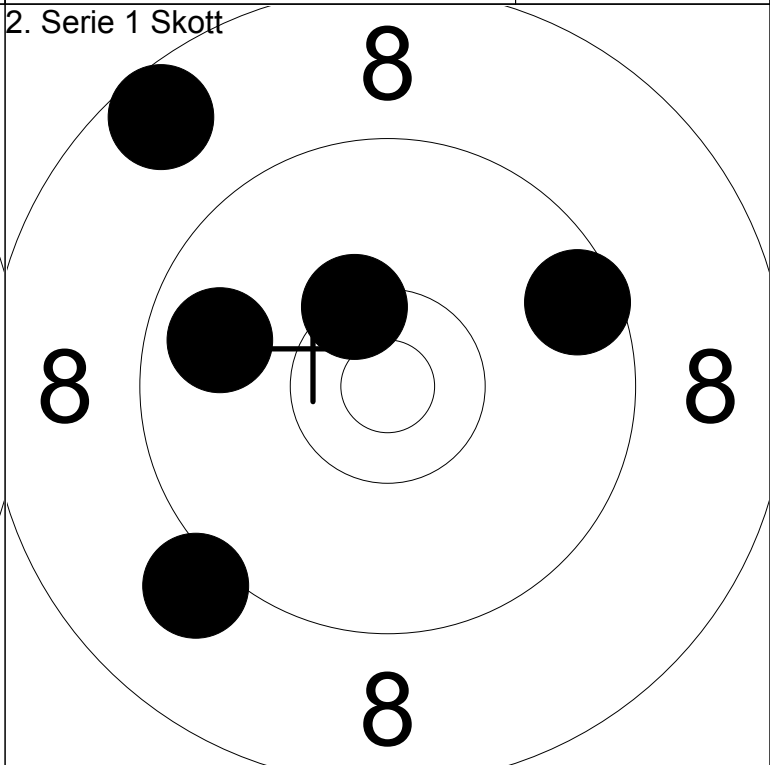
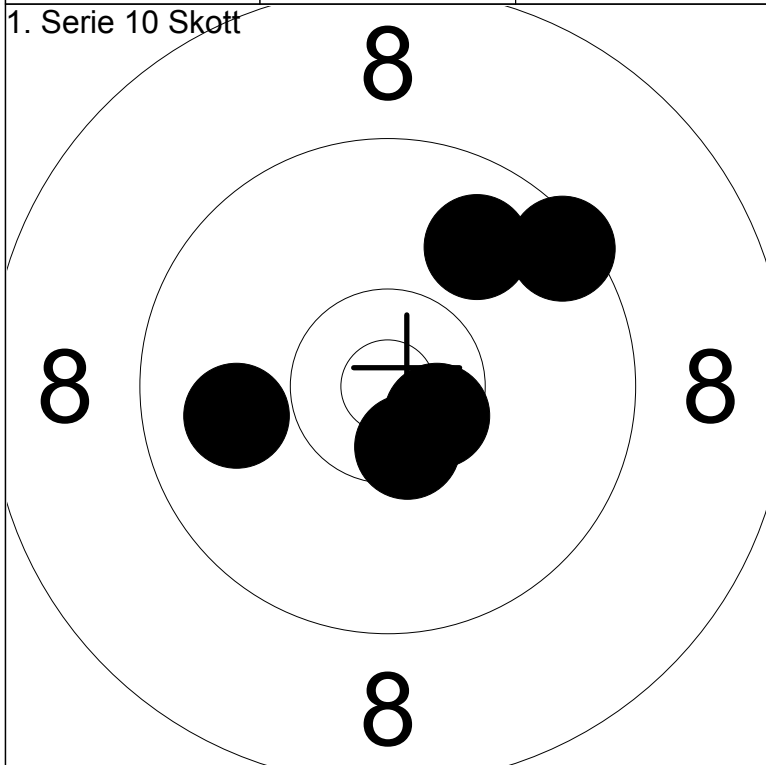

6: *10.5 ↘	Serie	47.0
7: 9.9 ←		
8: *10.6 ↘	Total	286.0
9: 9.5 ↗		
10: 9.9 ↗		

1: 9.8 ←	Serie	45.0
2: *10.4 ↗		
3: 9.6 ↗	Total	331.0
4: 9.1 ↘		
5: 8.6 ↗		

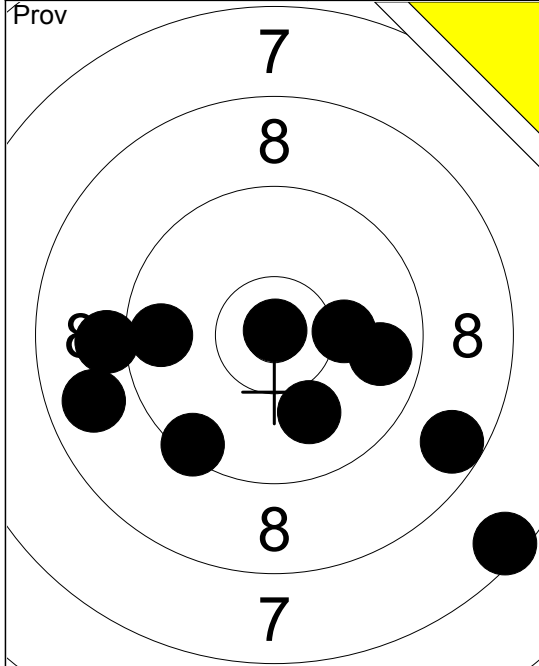

1:	7.5	↘
2:	9.8	→
3:	8.7	↘
4:	9.1	←
5:	9.4	↙
6:	9.7	←
7:	8.8	←
8:	10.0	↘
9:	10.2	→
10:	*10.9	↑
Serie		89.0
Total		191.0

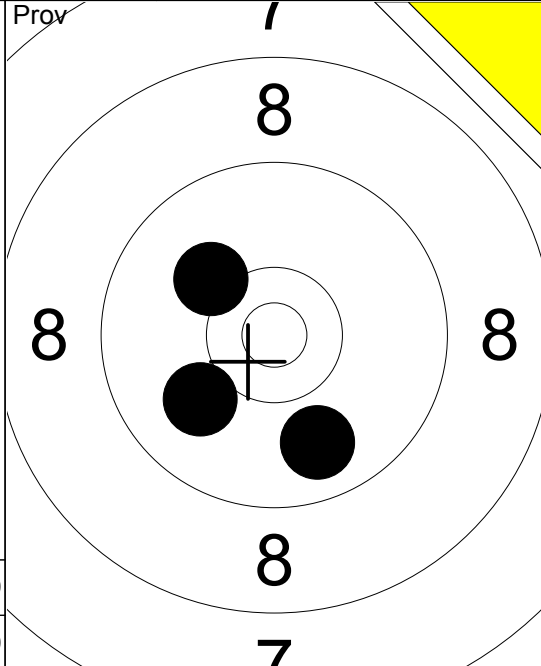

11:	10.1	↖
12:	9.8	↘
13:	10.0	↙
Serie		29.0
Total		191.0

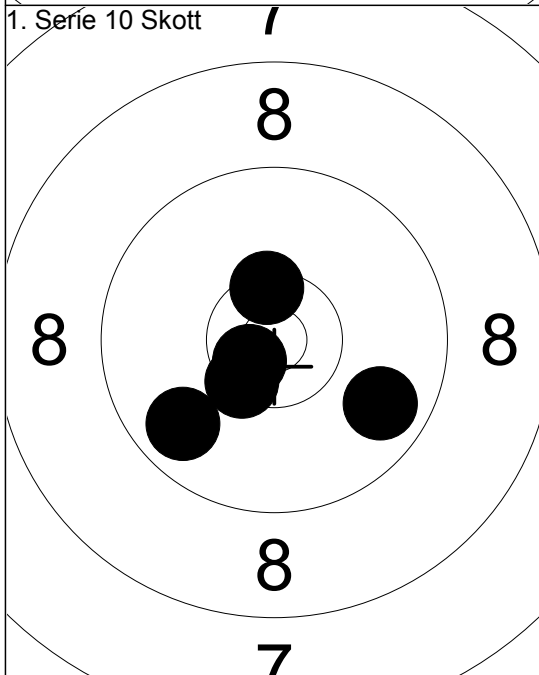

1:	9.8	↘
2:	9.8	↙
3:	*10.4	↘
4:	*10.6	↙
5:	*10.4	↑
Serie		48.0
Total		239.0

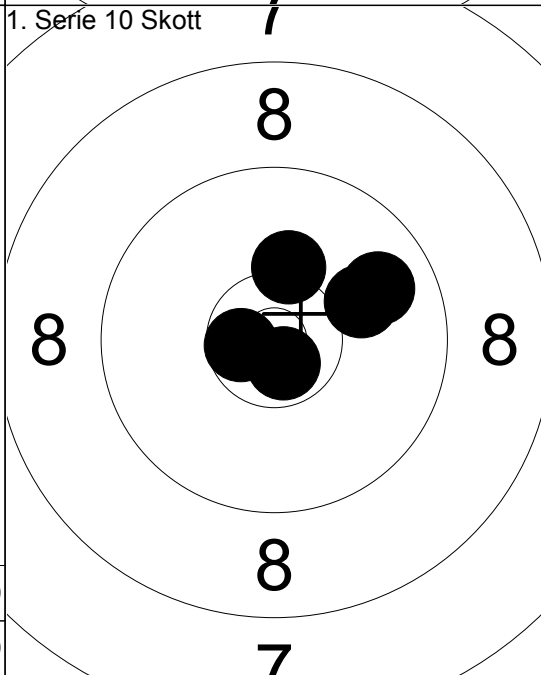

6:	*10.7	↘
7:	10.2	↑
8:	9.9	↗
9:	10.0	↗
10:	*10.6	←
Serie		49.0
Total		288.0

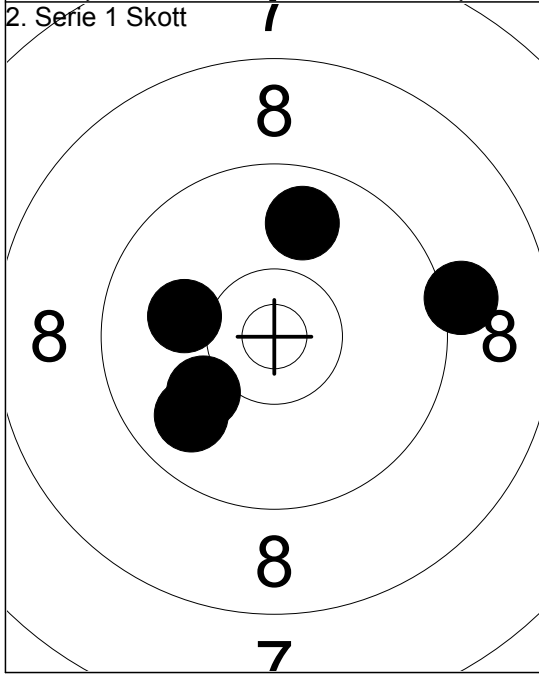

1:	9.1	→
2:	10.1	↙
3:	10.1	←
4:	9.9	↙
5:	9.8	↑
Serie		47.0
Total		335.0

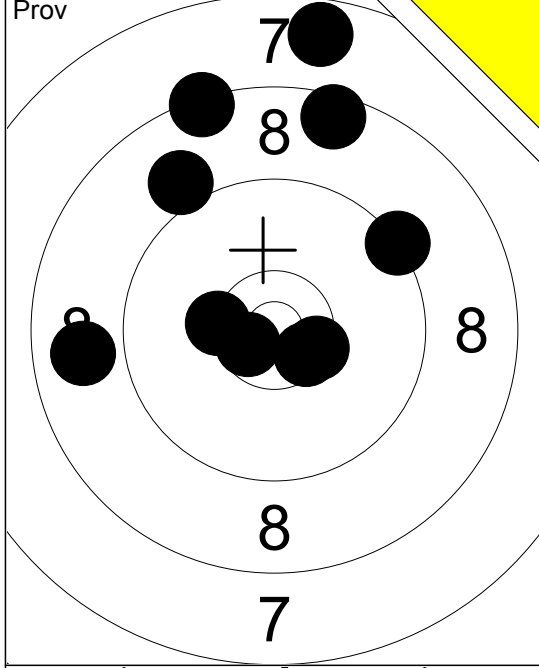

1:	*10.3	←
2:	*10.6	↙
3:	*10.5	↘
4:	8.9	←
5:	9.3	↗
6:	8.5	↑
7:	*10.5	↘
8:	9.0	↗
9:	8.4	↑
10:	7.7	↑
Serie		89.0
Total		191.0

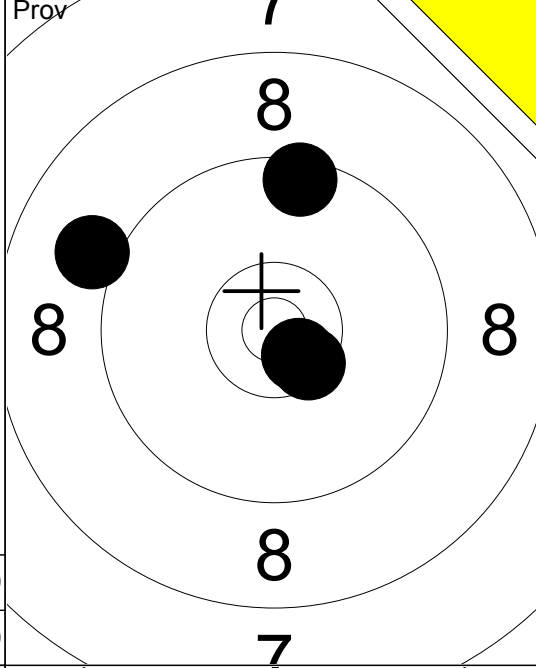

11:	9.1	↖
12:	*10.5	↘
13:	9.5	↑
14:	*10.6	↘
Serie		38.0
Total		191.0

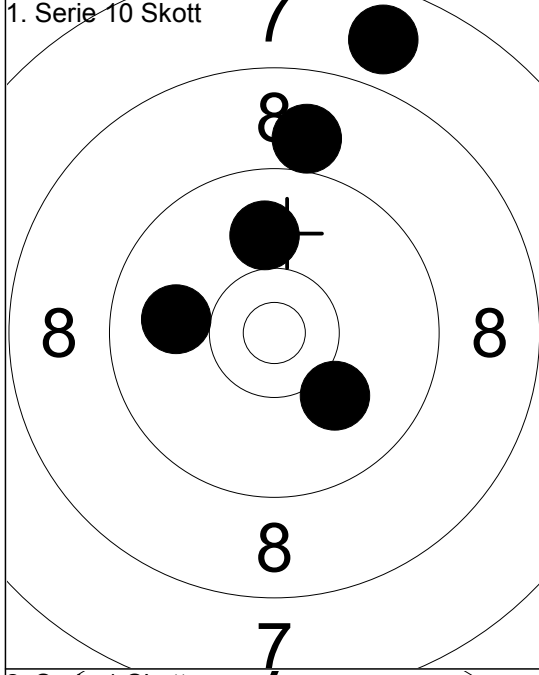

1:	10.0	←
2:	9.0	↑
3:	7.8	↗
4:	10.1	↘
5:	10.0	↑
Serie		46.0
Total		237.0

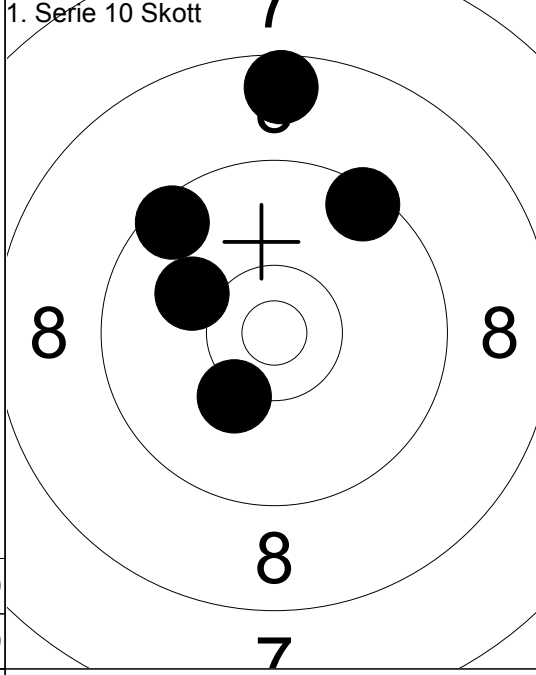

6:	9.5	↗
7:	10.2	↘
8:	9.5	↖
9:	10.1	↖
10:	8.6	↑
Serie		46.0
Total		283.0

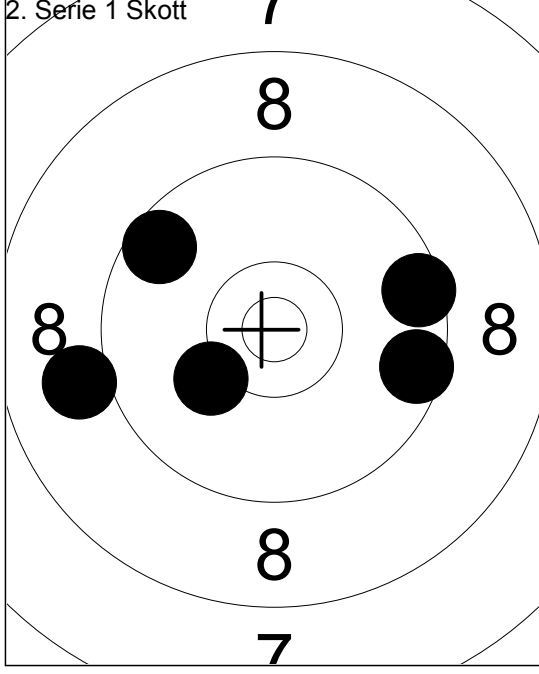

1:	9.5	→
2:	9.6	→
3:	10.2	↙
4:	9.0	←
5:	9.6	↖
Serie		46.0
Total		329.0

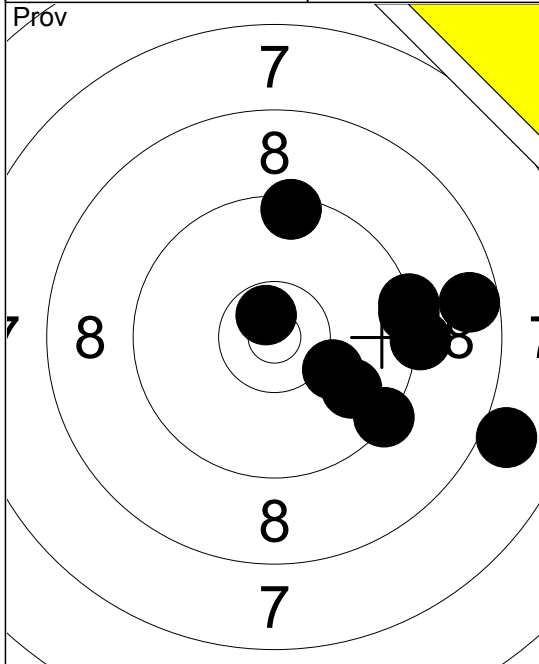

1:	8.6	→
2:	9.3	→
3:	9.4	↑
4:	9.3	→
5:	9.4	↘
6:	9.9	↘
7:	8.0	↘
8:	9.4	→
9:	10.2	↘
10:	*10.7	↑
Serie		90.0
Total		190.0

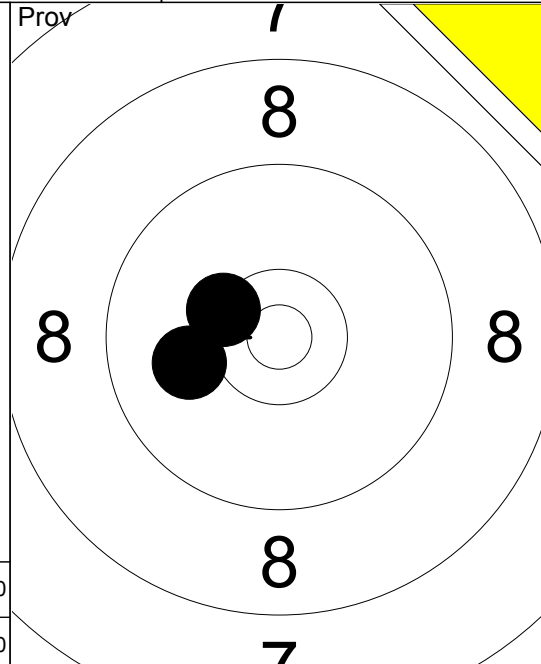

11:	*10.4	↖
12:	10.1	←
Serie		20.0
Total		190.0

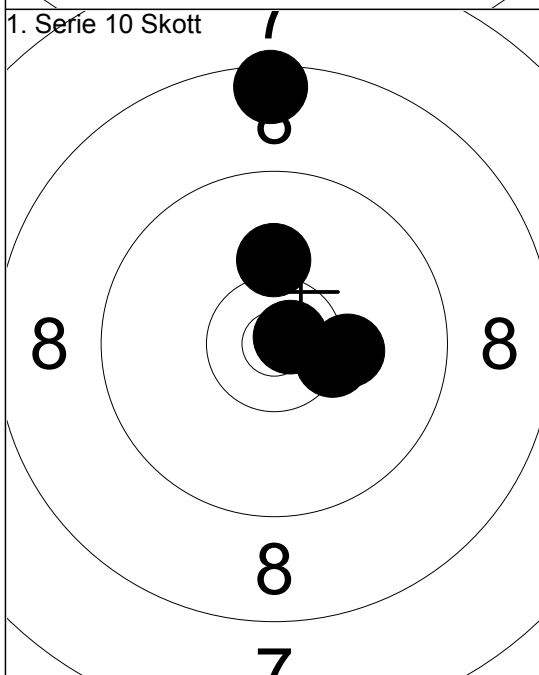

1:	*10.8	→
2:	10.2	→
3:	*10.4	→
4:	8.5	↑
5:	10.1	↑
Serie		48.0
Total		238.0

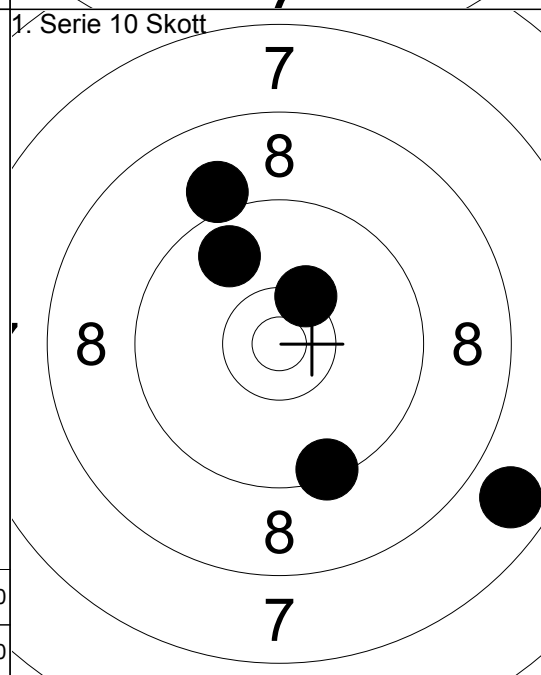

6:	7.8	↘
7:	9.4	↘
8:	9.1	↑
9:	*10.3	↗
10:	9.8	↗
Serie		44.0
Total		282.0

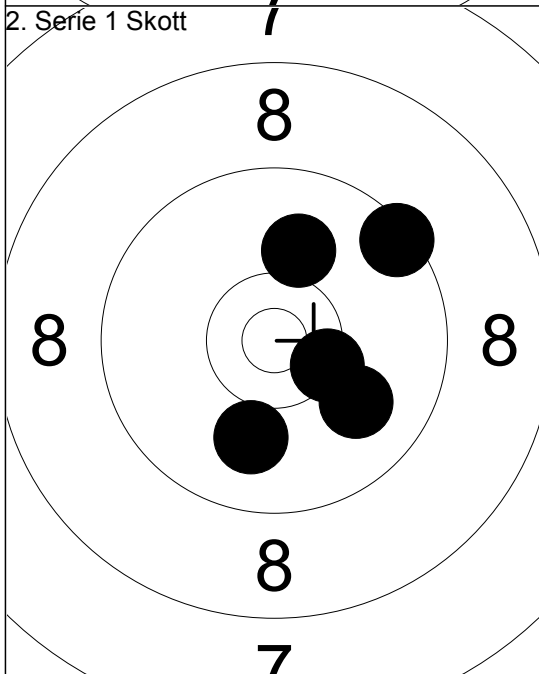

1:	10.0	↘
2:	9.4	↗
3:	*10.4	↘
4:	10.1	↑
5:	10.0	↘
Serie		49.0
Total		331.0

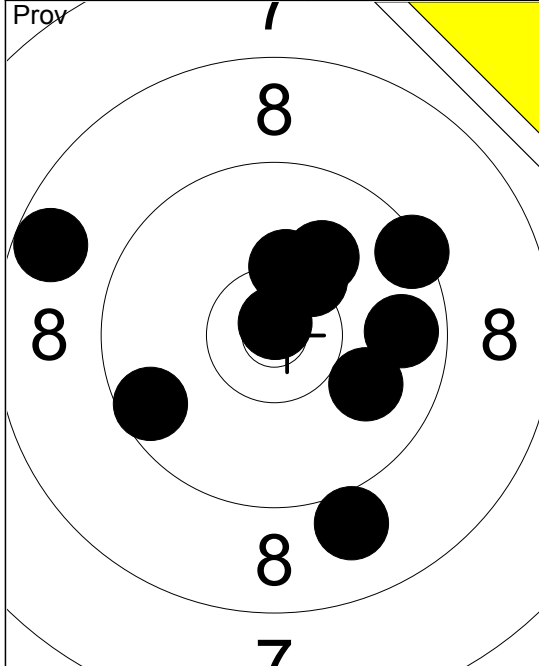

1:	9.0	↘
2:	9.6	↙
3:	10.3	↑
4:	9.7	→
5:	10.1	↗
6:	9.4	↘
7:	*10.3	↗
8:	10.0	↘
9:	8.7	↙
10:	*10.8	↑
Serie		94.0
Total		190.0

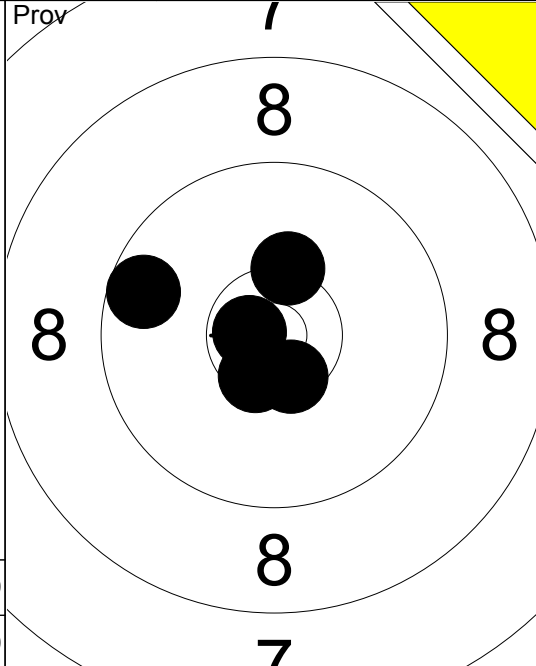

11:	*10.3	↑
12:	*10.5	↘
13:	9.6	↙
14:	*10.7	↙
15:	*10.5	↘
Serie		49.0
Total		190.0

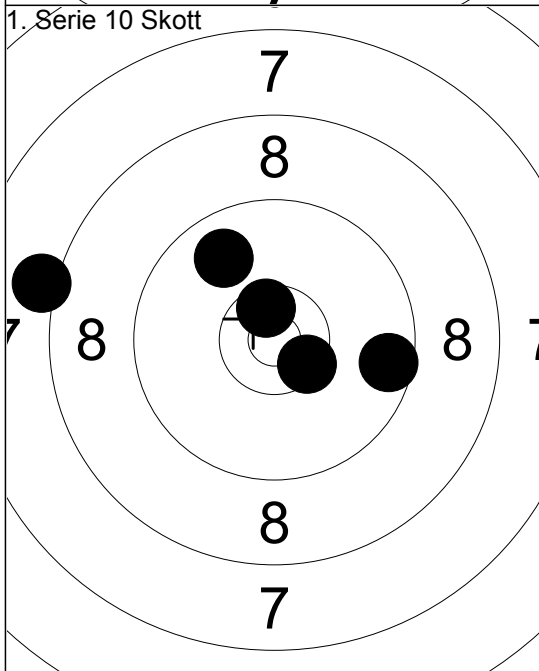

1:	8.1	↙
2:	*10.6	↑
3:	9.8	↗
4:	*10.5	↘
5:	9.6	→
Serie		46.0
Total		236.0

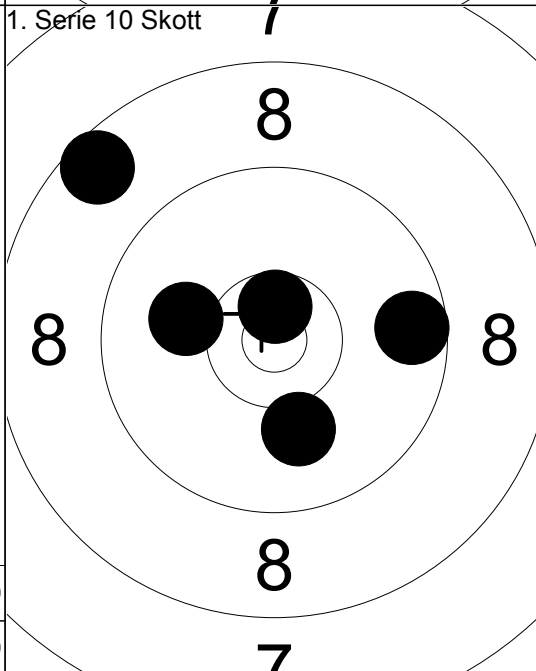

6:	9.6	→
7:	10.1	↙
8:	8.6	↗
9:	*10.6	↑
10:	10.1	↘
Serie		47.0
Total		283.0

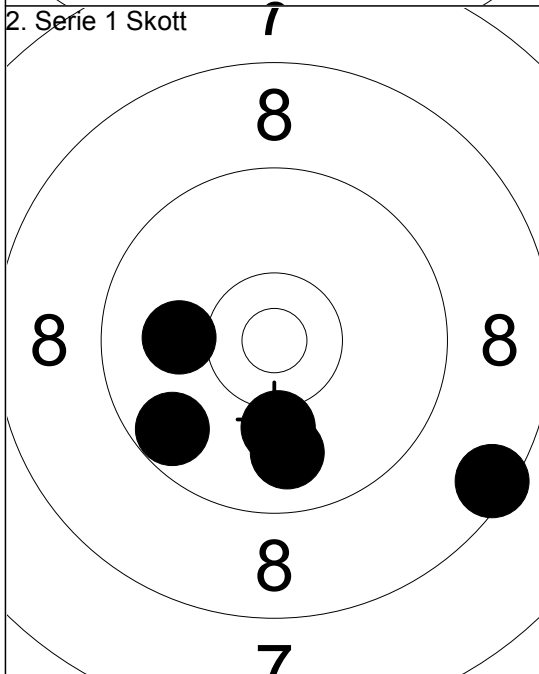

1:	10.0	↙
2:	9.7	↙
3:	9.9	↘
4:	10.1	↘
5:	8.5	↘
Serie		46.0
Total		329.0

Total		190.0
-------	--	-------

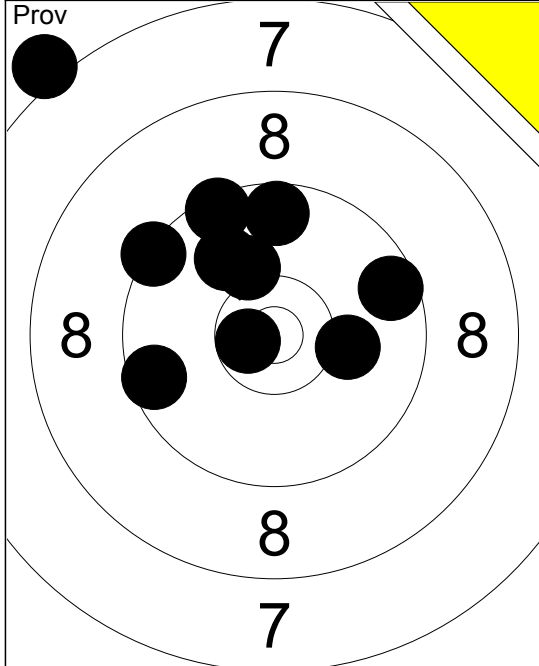

1:	10.0	↗
2:	7.1	↗
3:	10.2	↗
4:	9.6	↖
5:	9.4	↗
6:	*10.7	↖
7:	9.6	↑
8:	9.6	↗
9:	9.5	↗
10:	10.1	→
Serie		92.0
Total		190.0

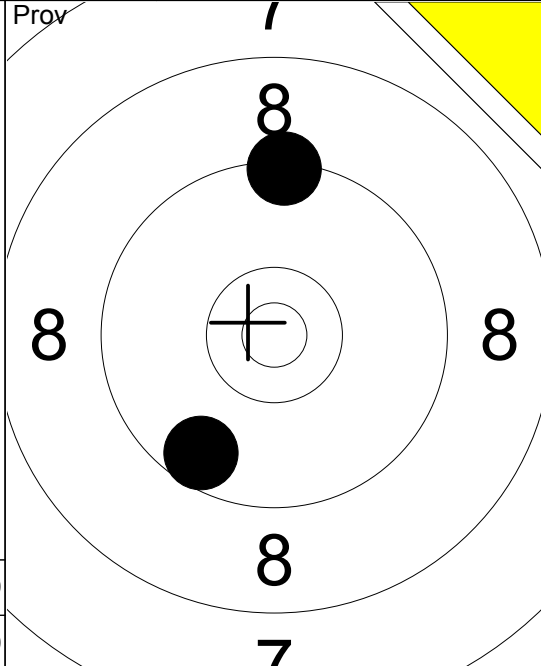

11:	9.6	↘
12:	9.4	↑
Serie		18.0
Total		190.0

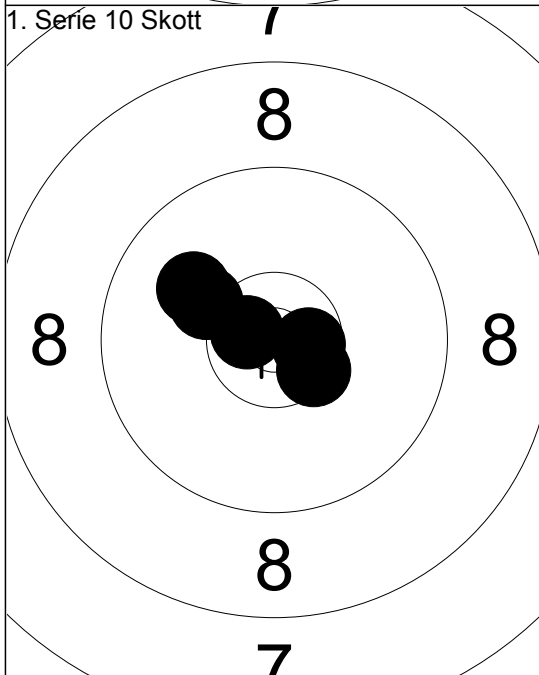

1:	10.0	↗
2:	10.2	↗
3:	*10.6	→
4:	*10.7	↖
5:	*10.5	↘
Serie		50.0
Total		240.0

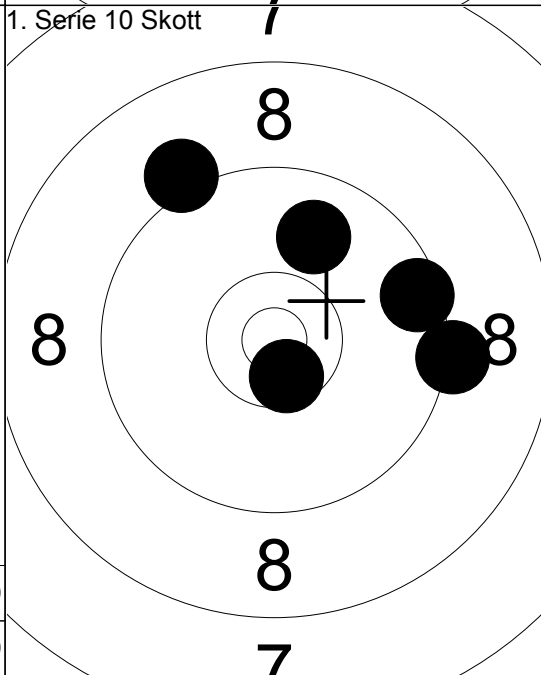

6:	9.2	→
7:	9.2	↗
8:	9.9	↗
9:	9.5	↗
10:	*10.6	↘
Serie		46.0
Total		286.0

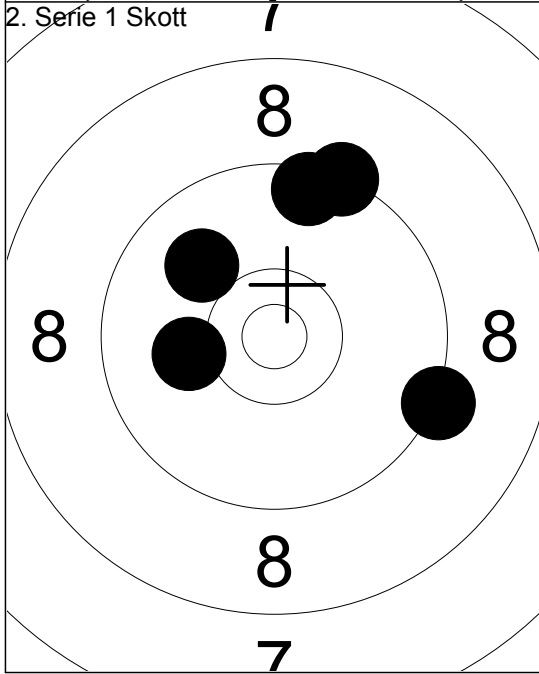

1:	9.3	↗
2:	9.5	↑
3:	9.3	↗
4:	10.1	↖
5:	10.0	↗
Serie		47.0
Total		333.0

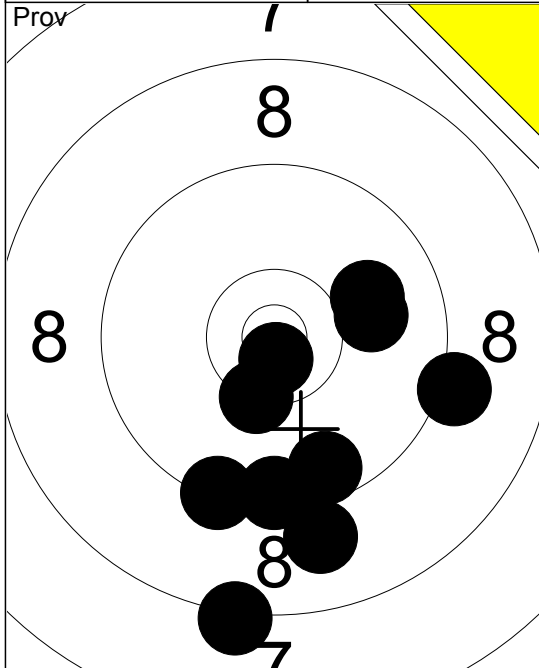

Prov

1:	8.2	↓
2:	9.5	↓
3:	*10.4	↓
4:	9.0	↓
5:	9.6	↓
6:	9.4	↓
7:	10.0	→
8:	9.2	→
9:	10.0	→
10:	*10.7	↓
Serie	93.0	
Total	192.0	

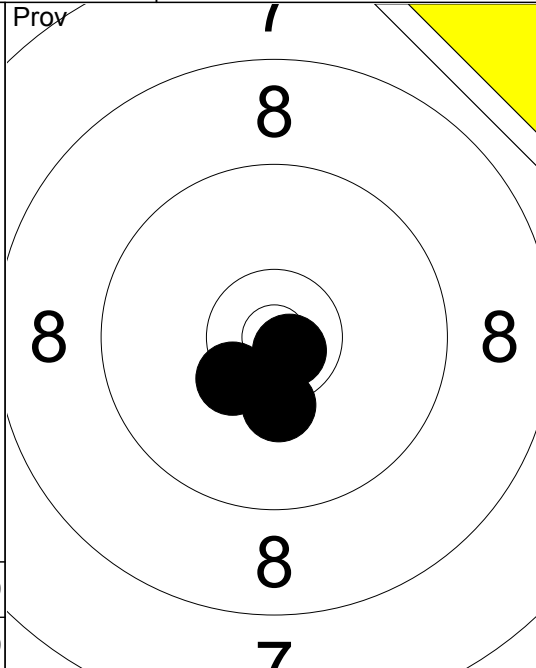

Prov

11:	*10.8	↘
12:	*10.3	↓
13:	*10.4	↙
Serie	30.0	
Total	192.0	

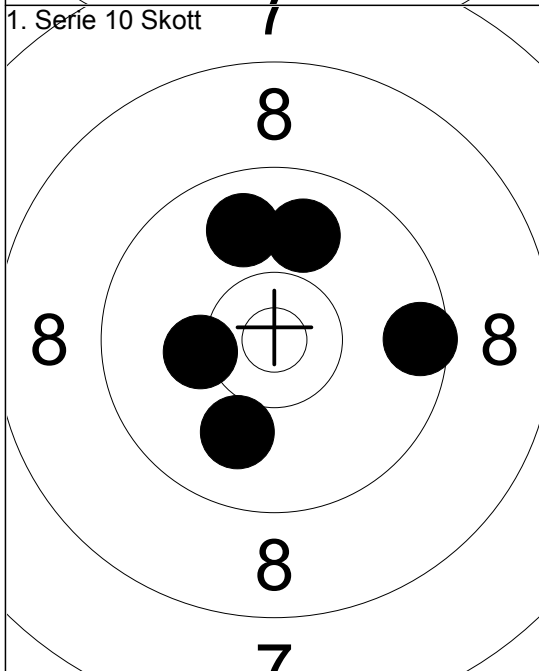

1:	10.0	↓
2:	9.9	↑
3:	10.2	←
4:	9.6	→
5:	9.9	↑
Serie	47.0	
Total	239.0	

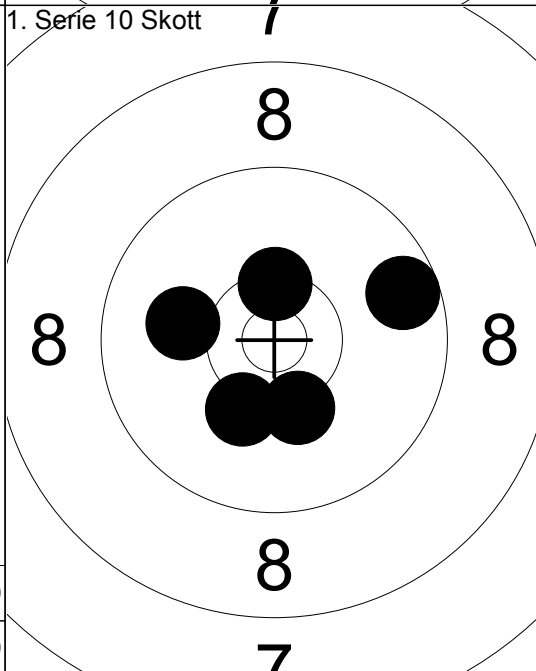

6:	9.6	→
7:	10.3	↓
8:	*10.4	↑
9:	10.2	↓
10:	10.1	←
Serie	49.0	
Total	288.0	

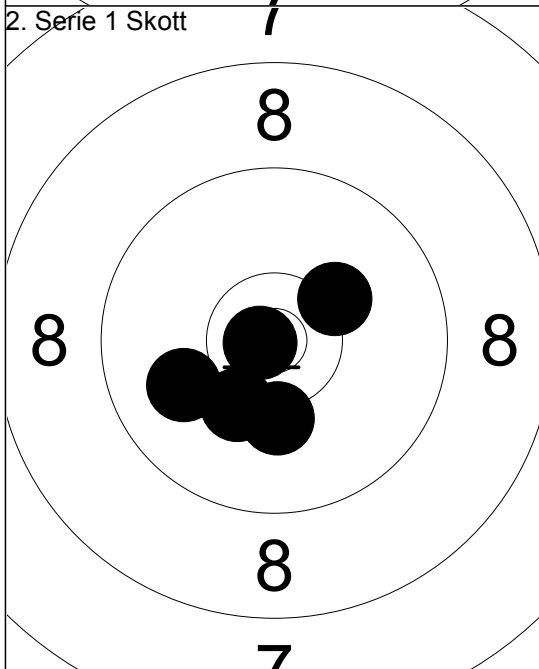

1:	10.2	↗
2:	10.2	↓
3:	*10.8	←
4:	10.0	↙
5:	10.2	↘
Serie	50.0	
Total	338.0	

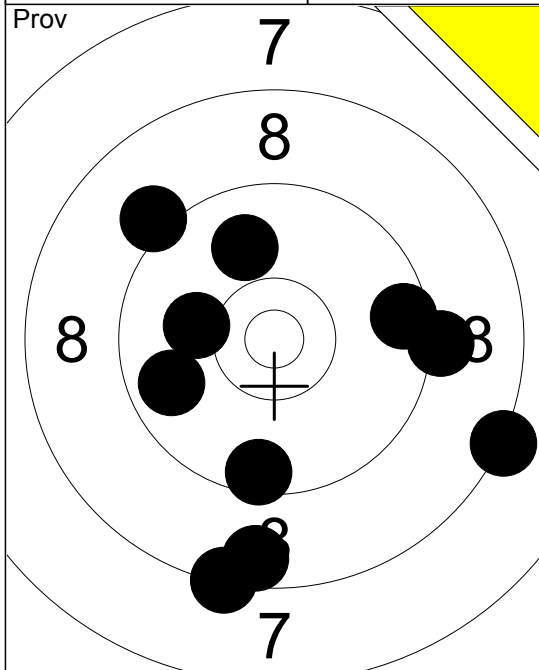

- 1: 8.3 ↓
- 2: 8.6 ↓
- 3: 9.8 ←
- 4: 9.1 ↗
- 5: 10.1 ←
- 6: 9.5 ↓
- 7: 9.6 →
- 8: 9.2 →
- 9: 8.3 ↘
- 10: 9.9 ↗

Serie 88.0
Total 191.0

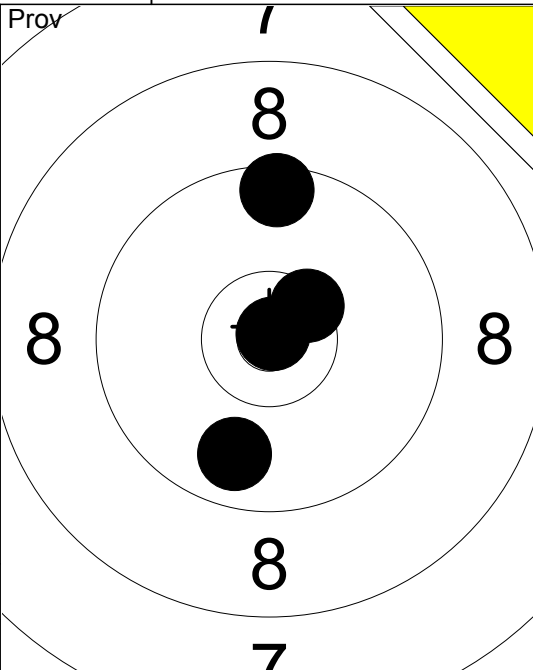

- 11: 9.8 ↓
- 12: *10.9 ↗
- 13: *10.5 ↗
- 14: 9.5 ↑

Serie 38.0
Total 191.0

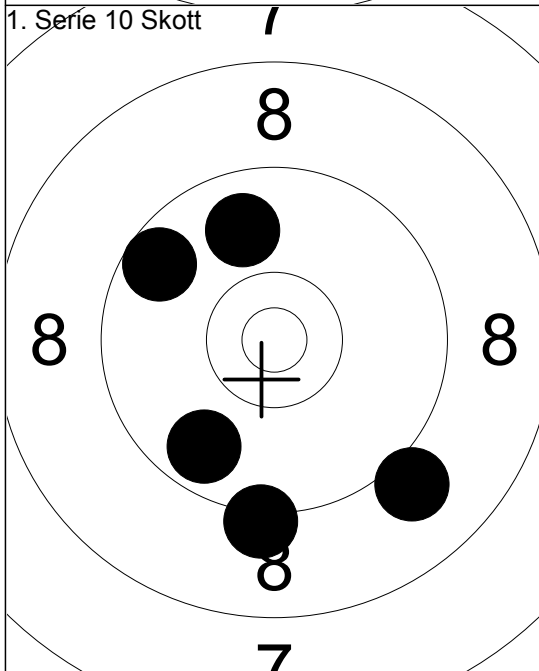

- 1: 9.7 ↓
- 2: 9.6 ↗
- 3: 9.2 ↓
- 4: 9.9 ↗
- 5: 9.1 ↓

Serie 45.0
Total 236.0

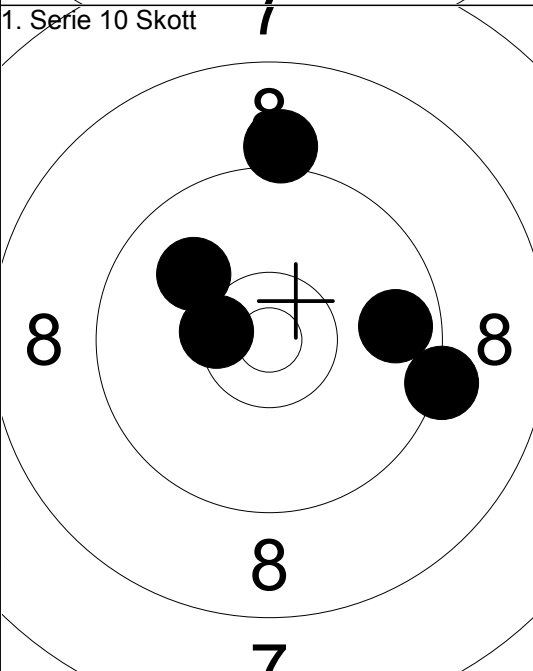

- 6: 9.7 →
- 7: 9.3 →
- 8: *10.4 ←
- 9: 10.0 ↗
- 10: 9.1 ↑

Serie 47.0
Total 283.0

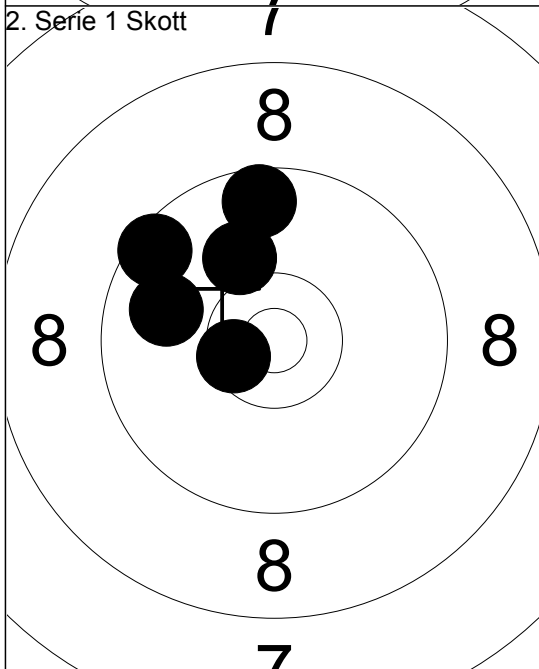

- 1: *10.5 ←
- 2: 9.9 ←
- 3: 9.5 ↗
- 4: 10.1 ↗
- 5: 9.6 ↑

Serie 47.0
Total 330.0

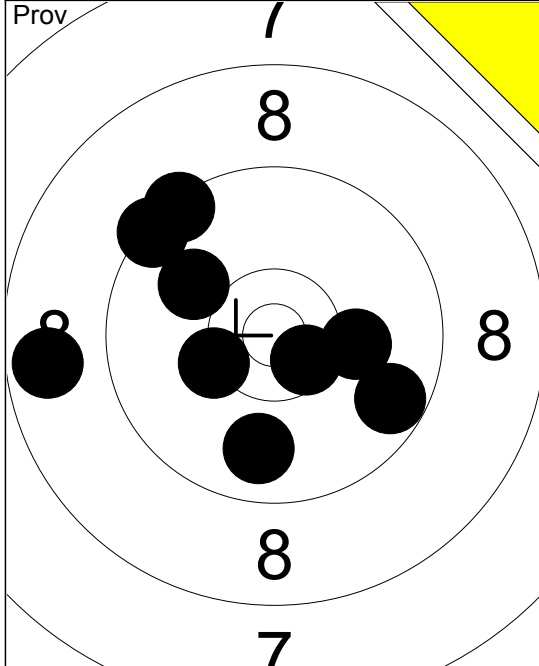

1:	*10.3	↙
2:	9.7	↘
3:	9.4	↗
4:	9.8	↘
5:	9.4	↗
6:	10.1	→
7:	10.0	↗
8:	*10.6	↘
9:	8.7	←
Serie		84.0
Total		186.0

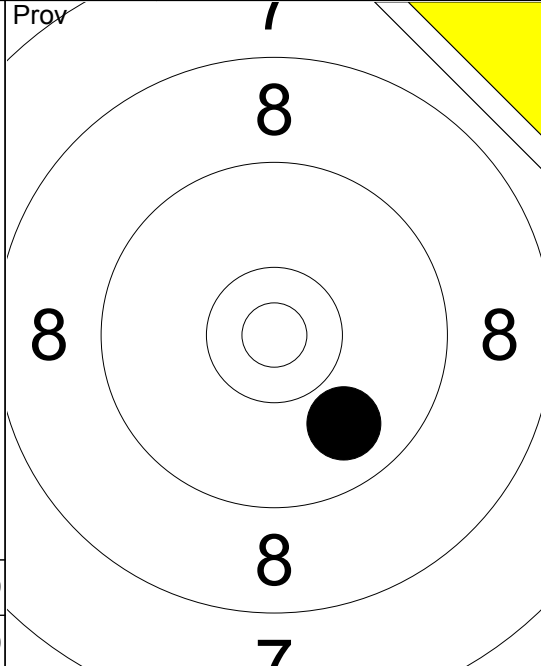

11:	9.9	↘
Serie		9.0
Total		186.0

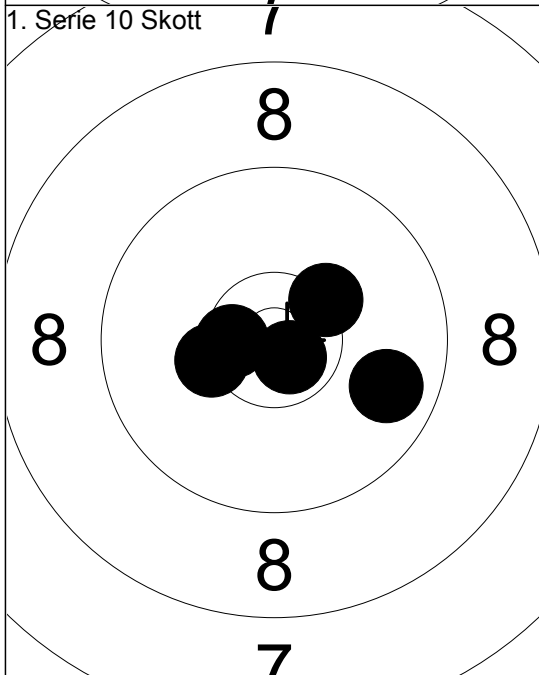

1:	*10.5	←
2:	*10.3	←
3:	*10.3	↗
4:	9.8	↘
5:	*10.7	↘
Serie		49.0
Total		235.0

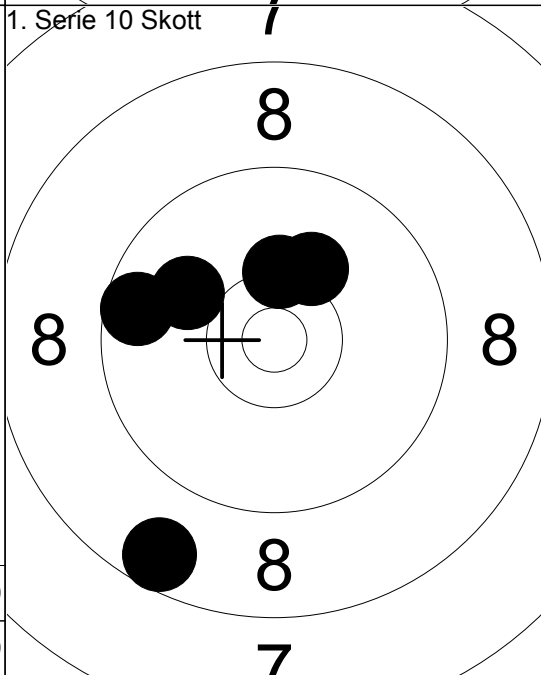

6:	10.0	↖
7:	*10.3	↑
8:	8.6	↘
9:	10.2	↗
10:	9.6	←
Serie		47.0
Total		282.0

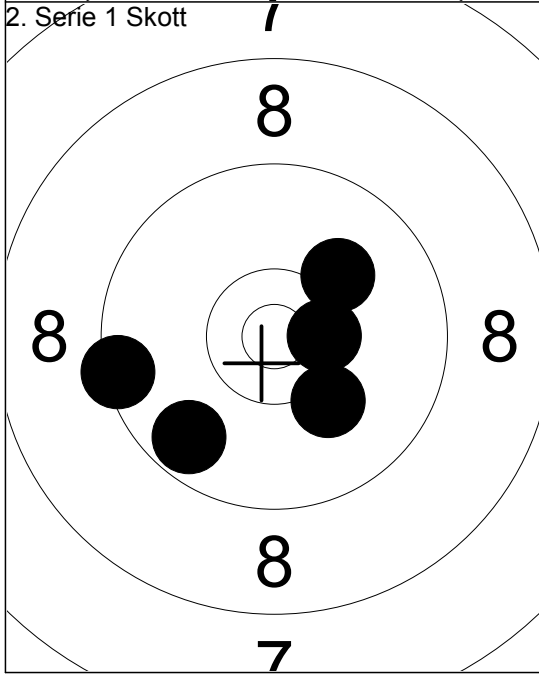

1:	10.1	↗
2:	*10.5	→
3:	10.2	↘
4:	9.7	↘
5:	9.4	←
Serie		48.0
Total		330.0

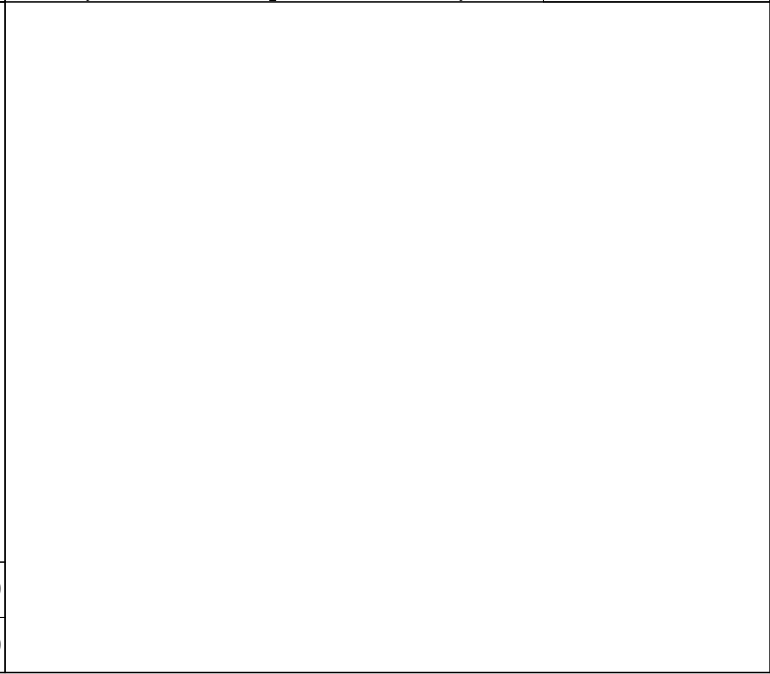

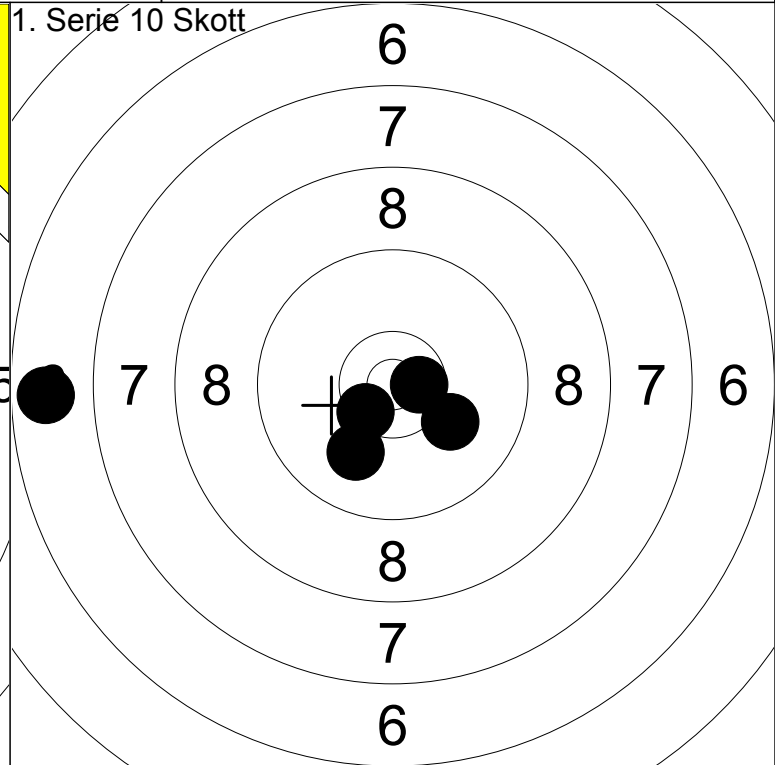
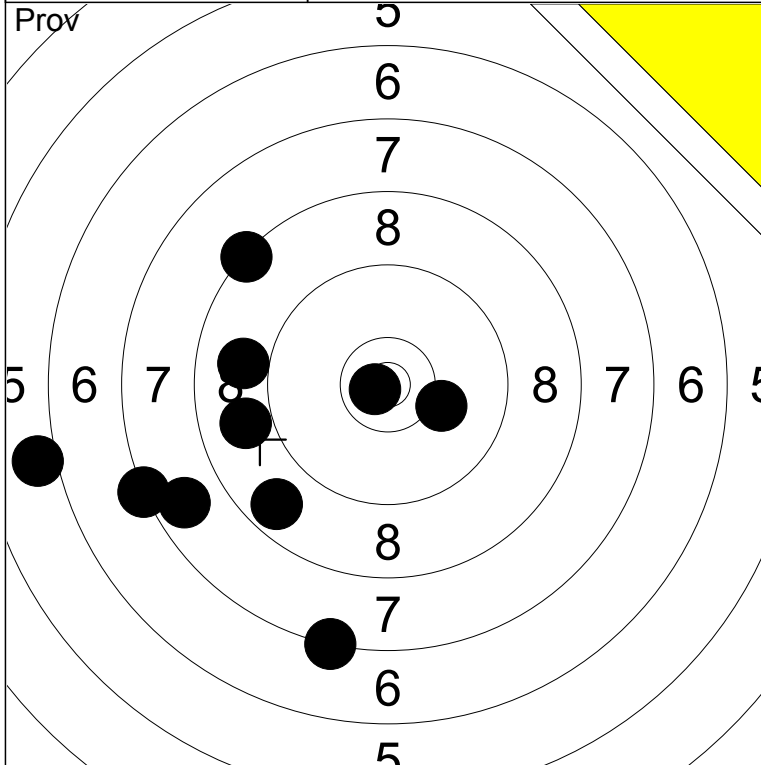

1: 7.3 ↓	6: 10.2 →	Serie	80.0
2: 8.3 ↗	7: 9.0 ←		
3: 7.7 ↙	8: 8.9 ←	Total	179.0
4: 6.0 ←	9: *10.8 ←		
5: 7.3 ←	10: 8.7 ↙		

1: *10.5 ↙	Serie	46.0
2: *10.6 →		
3: 10.1 ↘	Total	225.0
4: 6.7 ←		
5: 10.0 ↙		

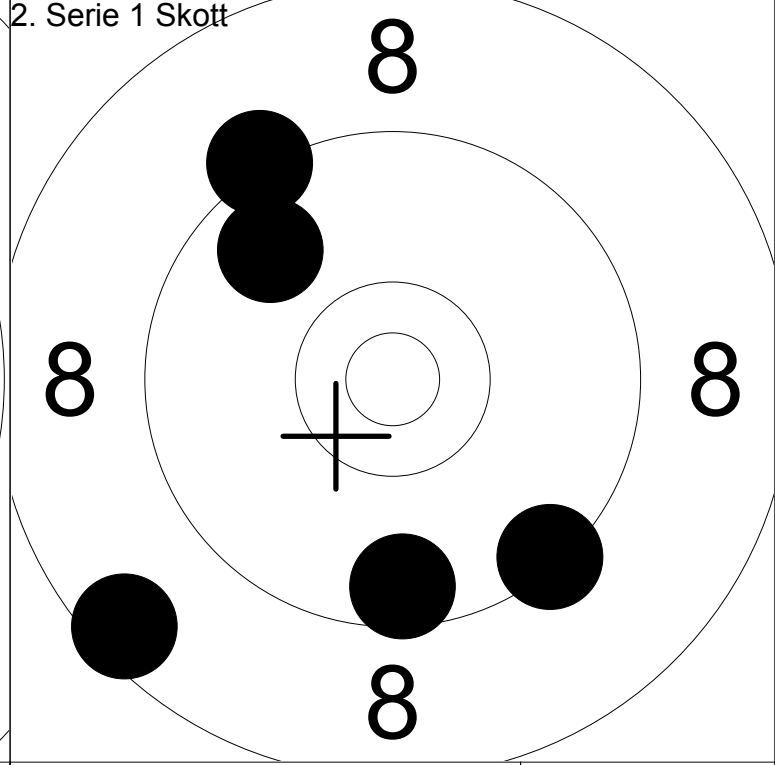
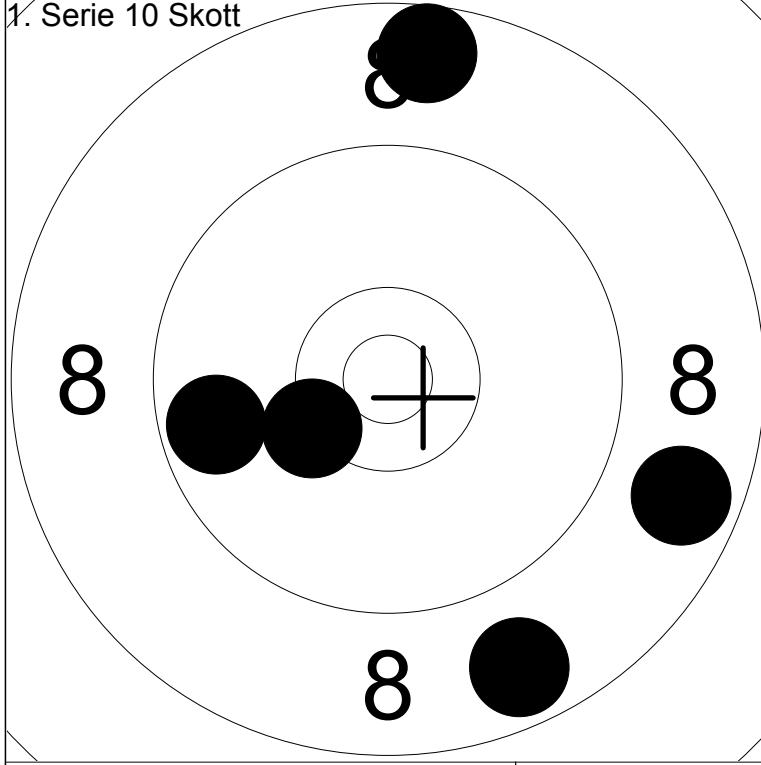

6: 8.7 ↓	Serie	43.0
7: 8.7 →		
8: 8.6 ↑	Total	268.0
9: 9.7 ←		
10: *10.3 ↙		

1: 9.8 ↗	Serie	44.0
2: 8.5 ↙		
3: 9.4 ↘	Total	312.0
4: 9.3 ↗		
5: 9.6 ↓		

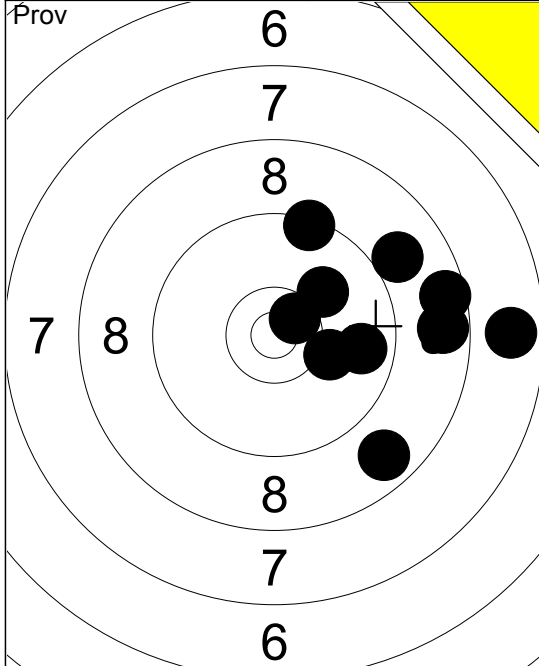

- 1: 8.7 ↘
- 2: 8.6 →
- 3: 10.1 ↗
- 4: 7.8 →
- 5: 8.7 →
- 6: 9.4 ↑
- 7: *10.6 ↗
- 8: 9.8 →
- 9: 9.0 ↗
- 10: 10.2 ↘

Serie 88.0

Total 193.0

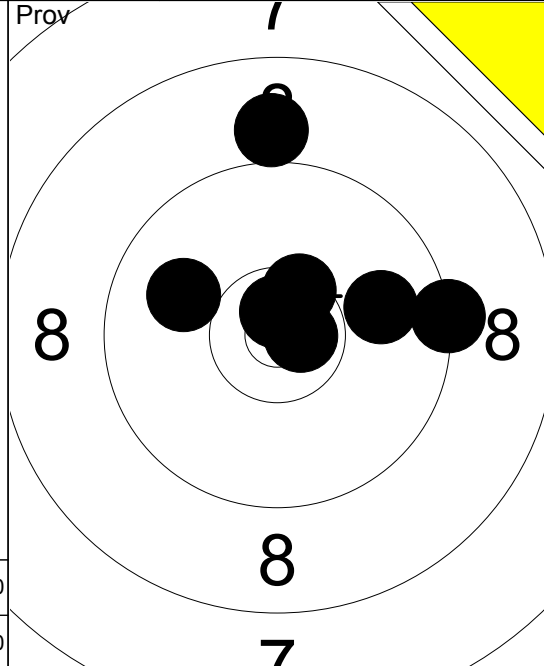

- 11: 10.0 ↖
- 12: 9.0 ↑
- 13: 9.3 →
- 14: 9.9 →
- 15: *10.7 ↑
- 16: *10.5 ↗
- 17: *10.7 →

Serie 67.0

Total 193.0

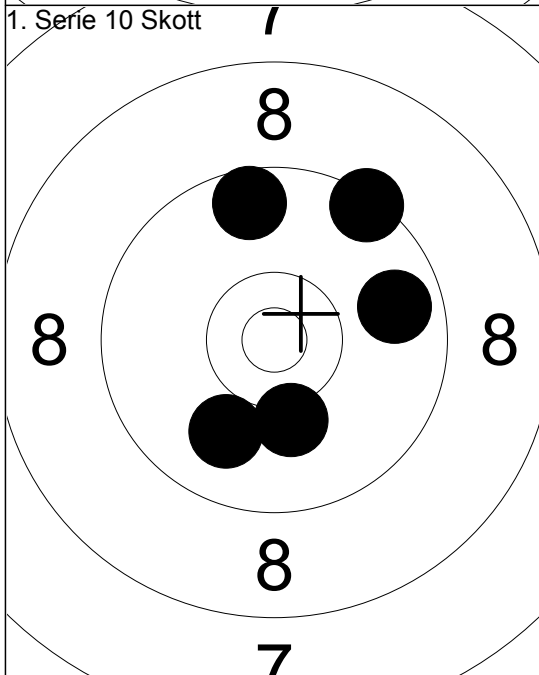

- 1: 10.2 ↓
- 2: 9.4 ↗
- 3: 9.6 ↑
- 4: 10.0 ↓
- 5: 9.8 →

Serie 47.0

Total 240.0

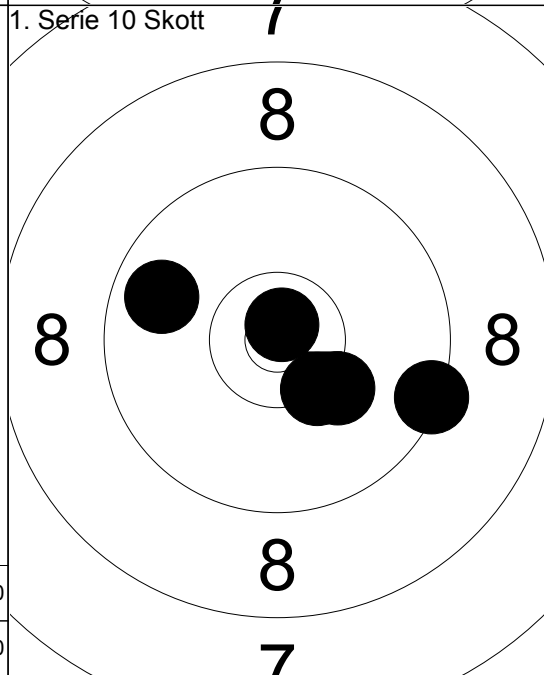

- 6: 10.2 ↘
- 7: 9.4 ↘
- 8: 9.8 ↖
- 9: *10.8 ↑
- 10: *10.3 ↘

Serie 48.0

Total 288.0

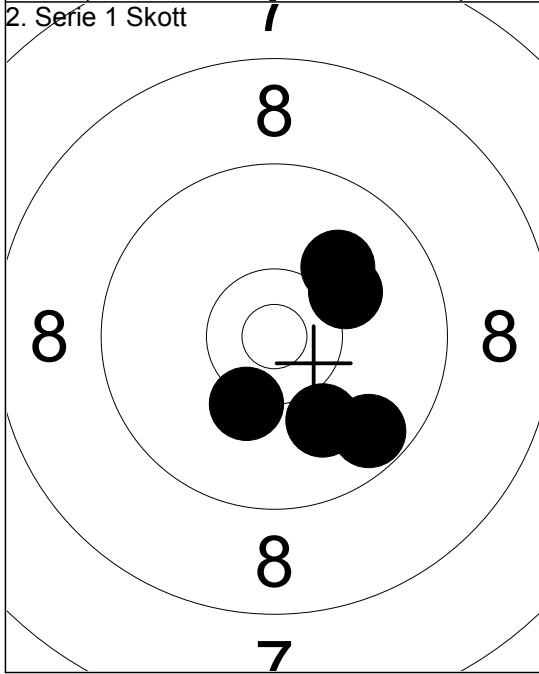

- 1: 10.3 ↓
- 2: 10.0 ↓
- 3: 9.7 ↘
- 4: 10.1 ↗
- 5: 10.1 ↗

Serie 49.0

Total 337.0

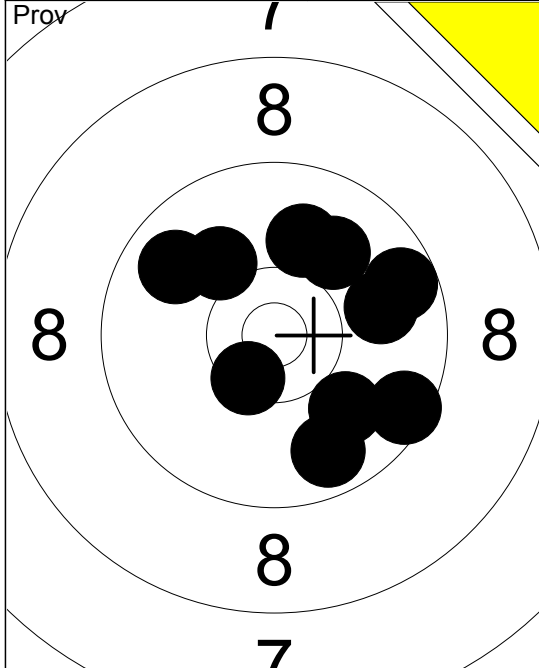

1:	10.0	↗
2:	9.7	↘
3:	10.0	↘
4:	9.7	→
5:	10.0	↗
6:	*10.5	↘
7:	9.9	→
8:	9.5	↘
9:	10.1	↗
10:	9.8	↗
Serie	95.0	
Total	191.0	

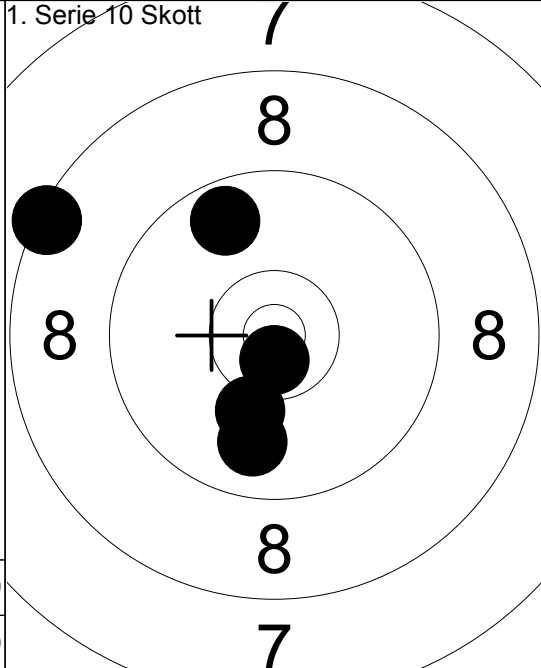

1:	9.7	↗
2:	10.2	↘
3:	9.9	↘
4:	*10.7	↘
5:	8.4	↖
Serie	46.0	
Total	237.0	

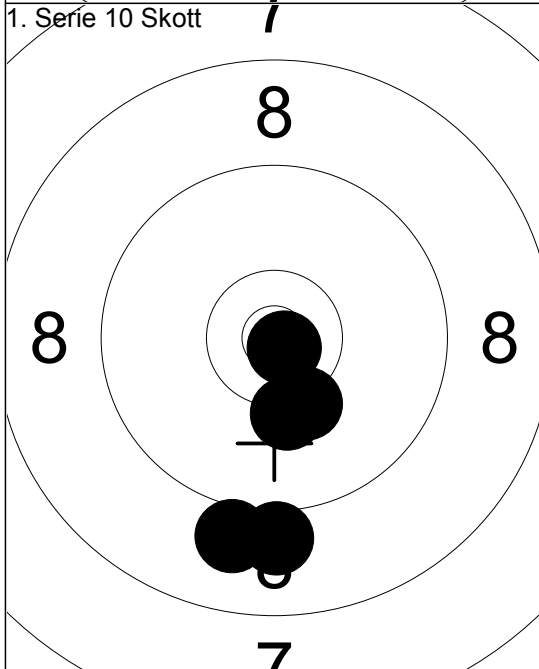

6:	10.3	↘
7:	9.0	↘
8:	10.2	↘
9:	9.0	↘
10:	*10.8	↘
Serie	48.0	
Total	285.0	

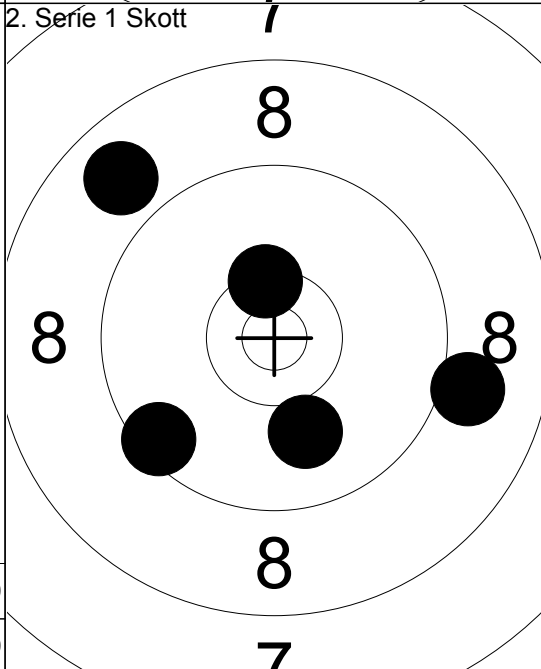

1:	9.0	→
2:	10.0	↘
3:	9.5	↖
4:	8.8	↗
5:	*10.4	↗
Serie	46.0	
Total	331.0	

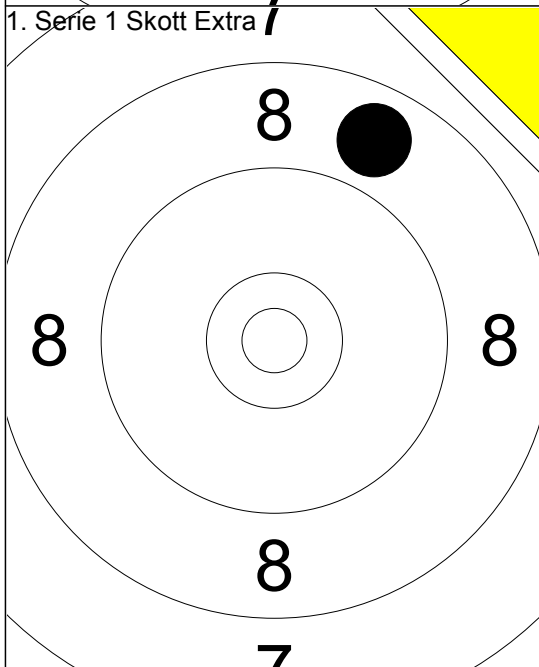

1:	8.8	↗
Serie	8.0	
Total	331.0	

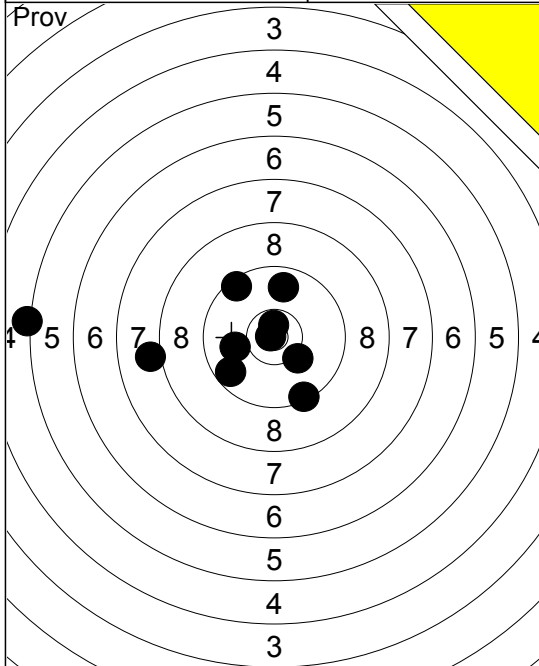

1:	8.1	←
2:	5.2	←
3:	9.5	↗
4:	9.8	↑
5:	10.2	↘
6:	9.4	↘
7:	9.7	↙
8:	*10.9	←
9:	10.0	←
10:	*10.7	↑
Serie	89.0	
Total	191.0	

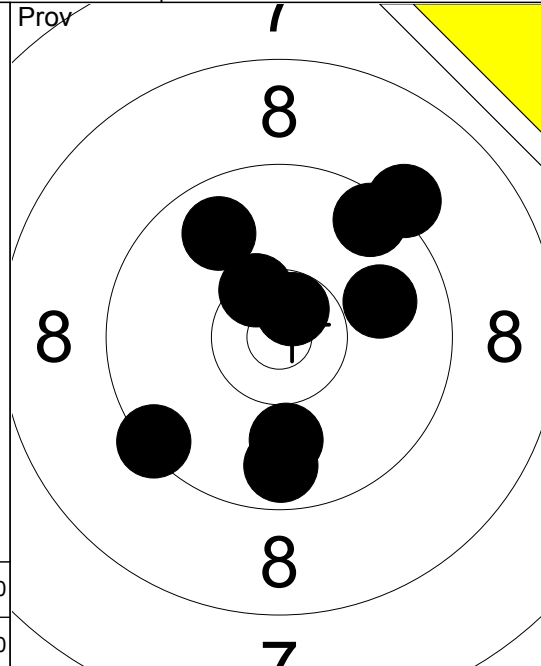

11:	9.9	↗
12:	9.7	↓
13:	10.0	↓
14:	9.5	↗
15:	9.8	↖
16:	*10.7	↗
17:	*10.5	↖
18:	9.4	↙
19:	9.2	↗
Serie	84.0	
Total	191.0	

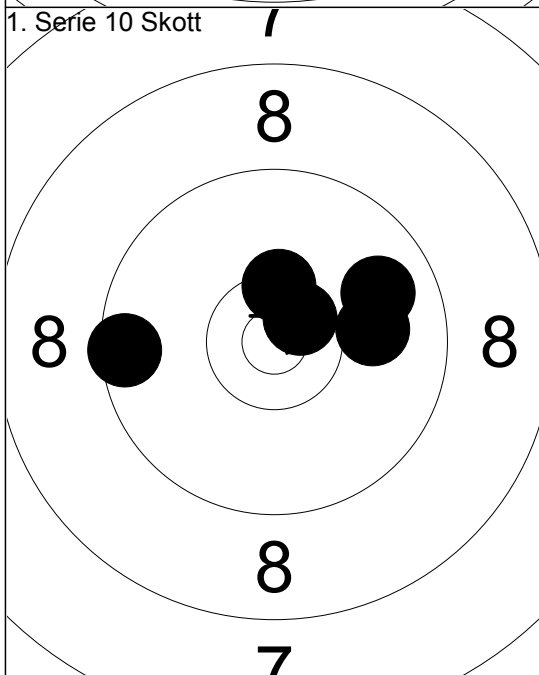

1:	10.0	→
2:	9.5	←
3:	*10.4	↑
4:	9.9	↗
5:	*10.6	↗
Serie	48.0	
Total	239.0	

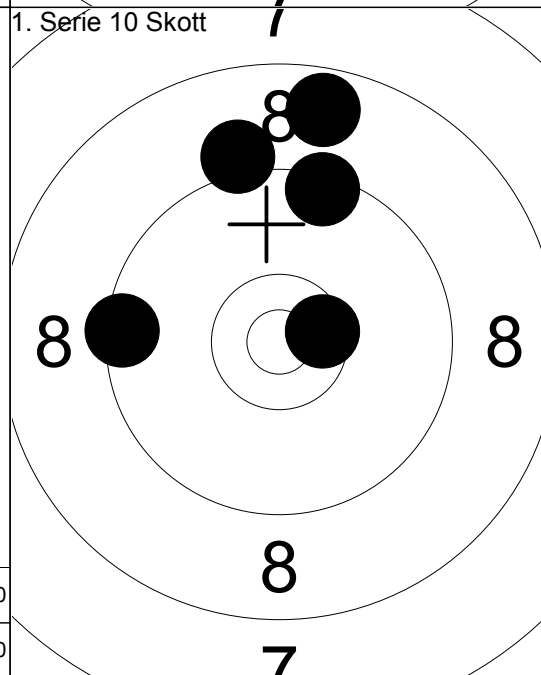

6:	9.1	↑
7:	*10.5	→
8:	8.7	↑
9:	9.4	↑
10:	9.4	←
Serie	45.0	
Total	284.0	

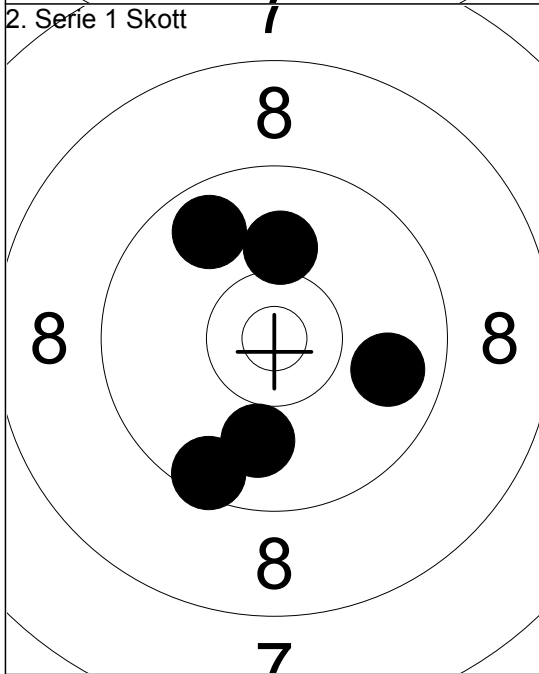

1:	9.8	→
2:	9.8	↗
3:	9.5	↘
4:	10.0	↘
5:	10.1	↑
Serie	47.0	
Total	331.0	

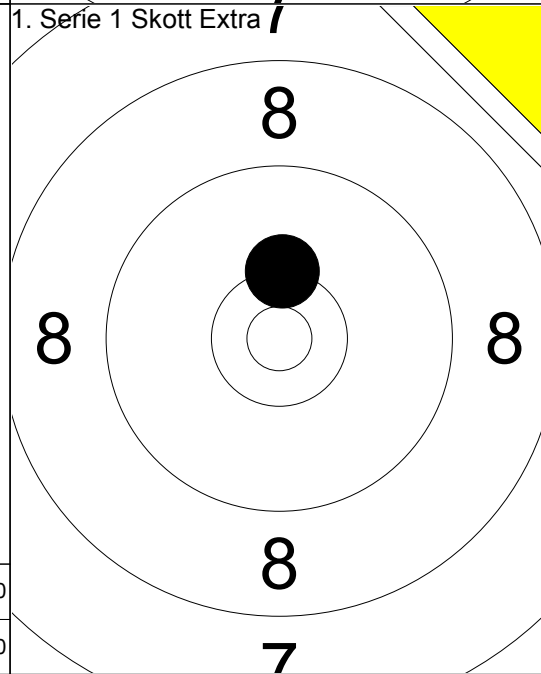

1:	*10.3	↑
Serie	10.0	
Total	331.0	

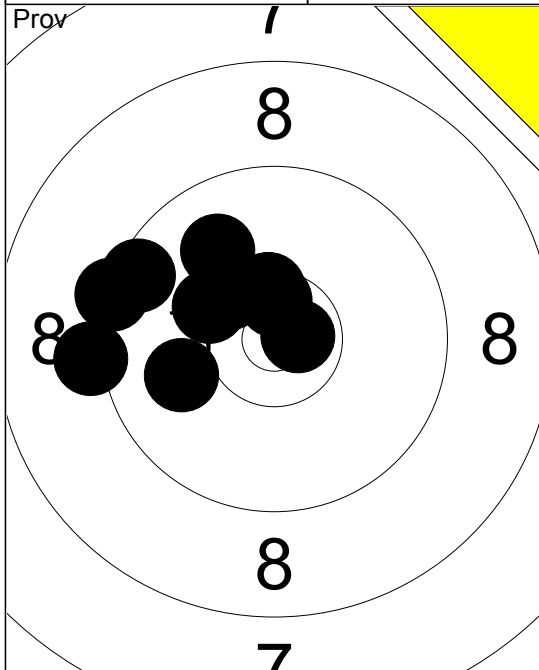

1:	9.2	←
2:	*10.5	↑
3:	10.0	←
4:	*10.6	↑
5:	*10.7	→
6:	9.5	↖
7:	9.3	←
8:	9.9	↗
9:	*10.3	↗
10:	10.3	↖
Serie		96.0
Total		190.0

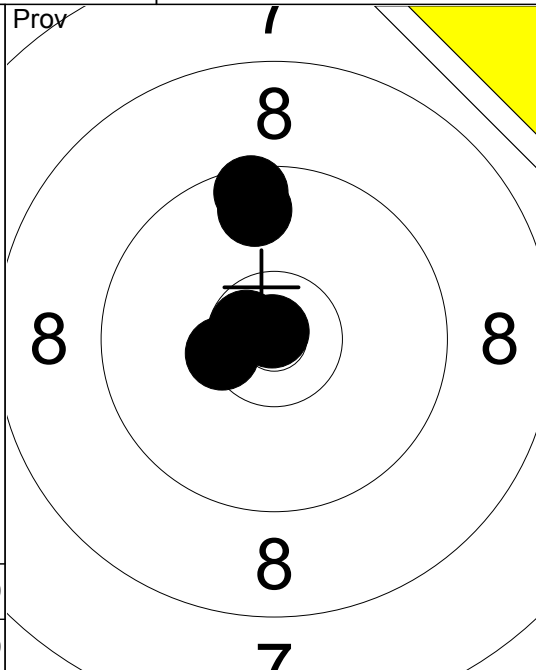

11:	9.5	↑
12:	*10.9	↑
13:	9.7	↑
14:	*10.4	←
15:	*10.7	↖
Serie		48.0
Total		190.0

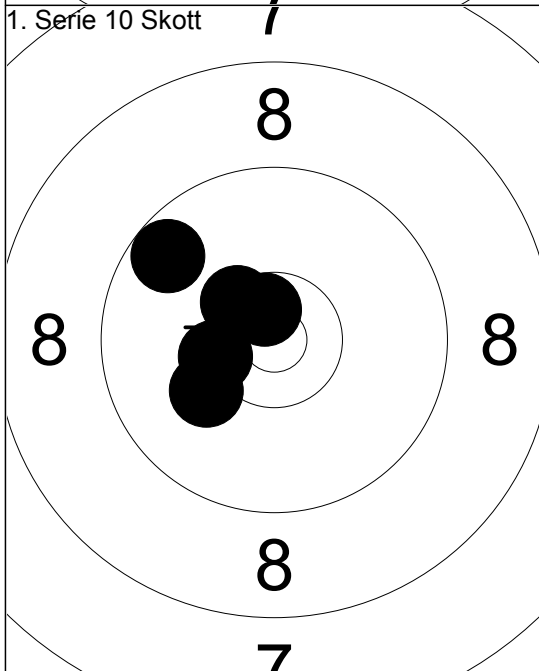

1:	*10.4	←
2:	*10.4	↖
3:	*10.7	↑
4:	9.7	↖
5:	10.1	↙
Serie		49.0
Total		239.0

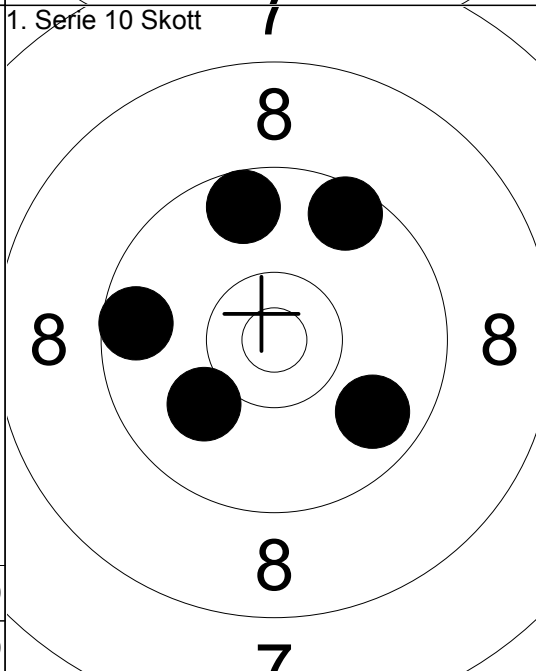

6:	9.7	↑
7:	9.6	↗
8:	9.8	↘
9:	10.0	↙
10:	9.6	←
Serie		46.0
Total		285.0

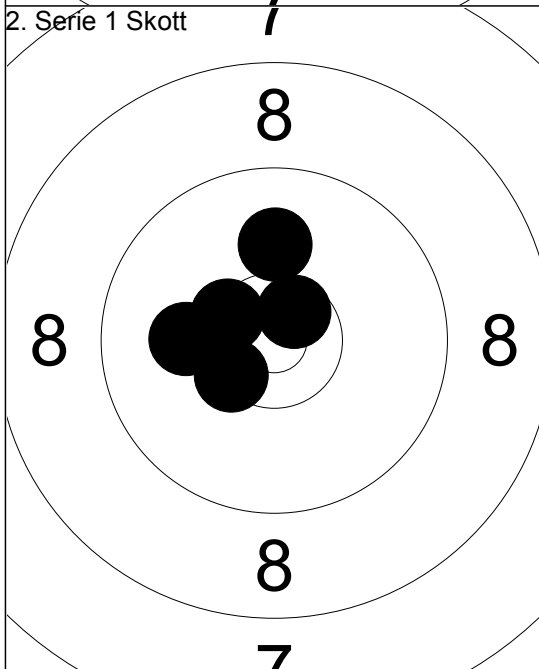

1:	10.1	←
2:	10.0	↑
3:	*10.4	↖
4:	*10.4	↙
5:	*10.6	↗
Serie		50.0
Total		335.0

Serie		48.0
Total		190.0

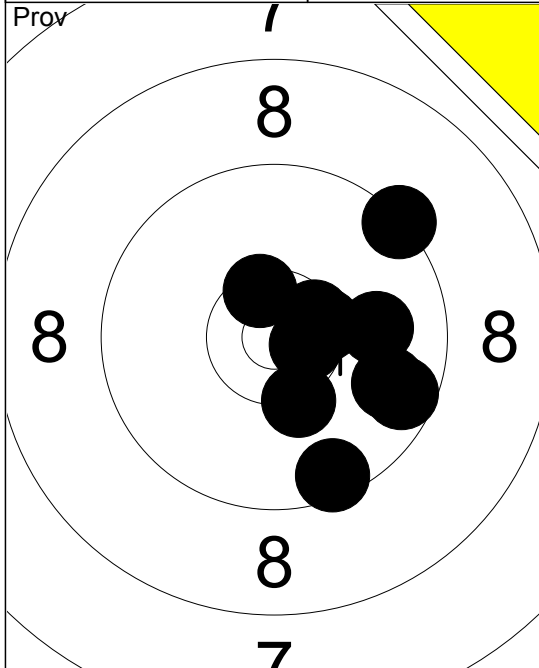

1:	9.6	→
2:	*10.5	→
3:	*10.3	↓
4:	*10.5	→
5:	9.8	→
6:	9.5	↓
7:	10.0	→
8:	9.3	↗
9:	*10.5	↑
10:	*10.6	→
Serie		96.0
Total		189.0

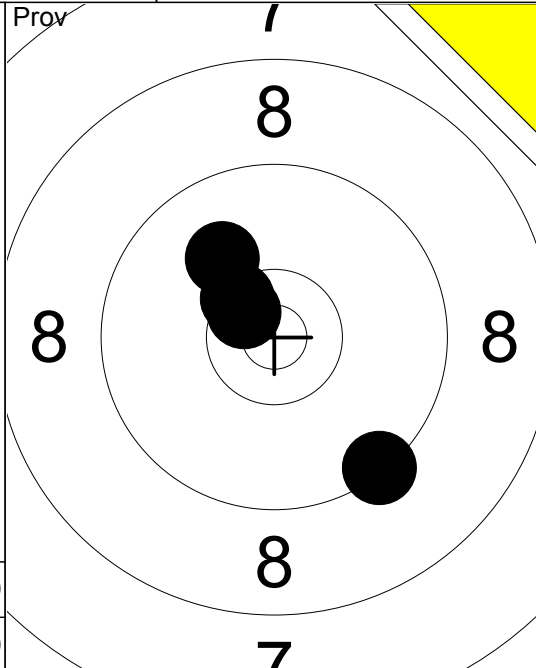

11:	*10.6	↖
12:	*10.4	↗
13:	10.1	↗
14:	9.4	↘
Serie		39.0
Total		189.0

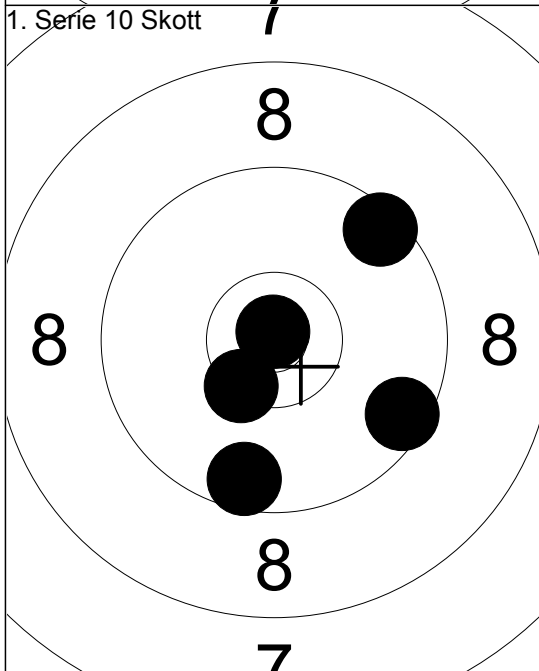

1:	9.5	↗
2:	9.5	→
3:	9.6	↓
4:	*10.9	↑
5:	*10.4	↘
Serie		47.0
Total		236.0

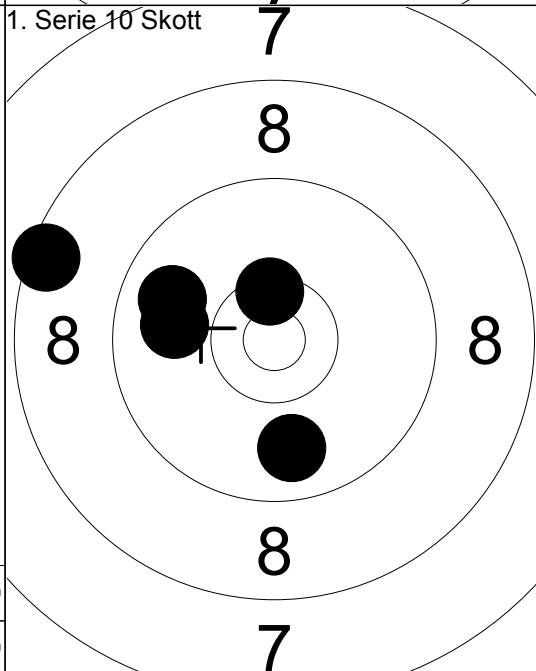

6:	8.5	←
7:	*10.5	↑
8:	9.8	↓
9:	9.9	←
10:	9.8	↖
Serie		45.0
Total		281.0

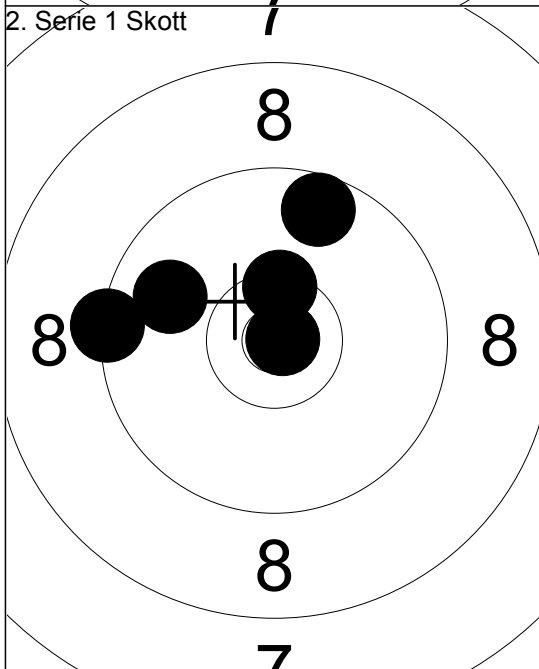

1:	9.6	↗
2:	9.9	←
3:	*10.4	↑
4:	9.4	←
5:	*10.9	→
Serie		47.0
Total		328.0



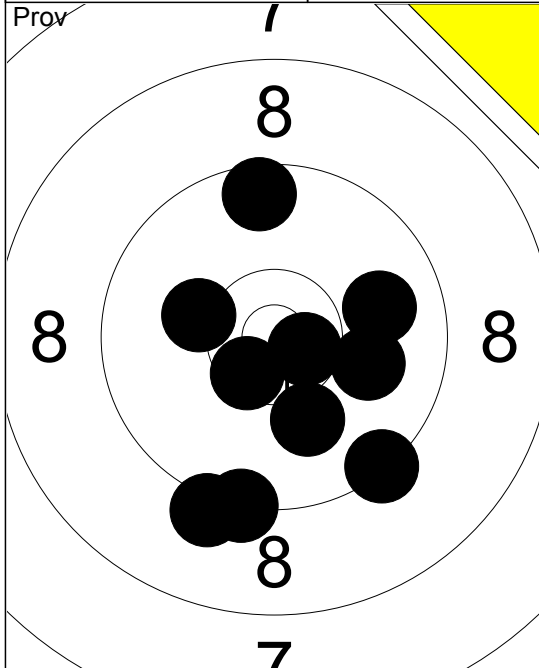

1:	9.9	→
2:	10.1	↓
3:	*10.6	↓
4:	9.3	↓
5:	10.0	→
6:	9.3	↓
7:	*10.5	↙
8:	9.6	↑
9:	10.2	←
10:	9.2	↓
Serie		95.0
Total		188.0

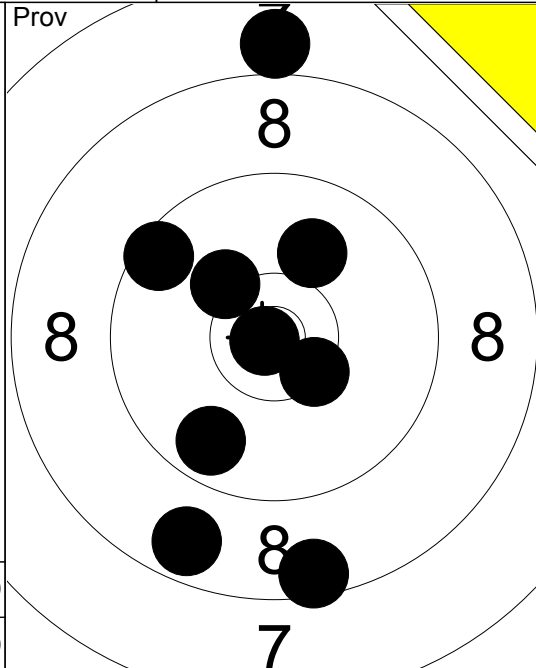

11:	9.5	↖
12:	8.7	↓
13:	8.5	↓
14:	10.0	↗
15:	10.2	↖
16:	*10.8	←
17:	*10.4	↘
18:	8.0	↑
19:	9.7	↘
Serie		82.0
Total		188.0

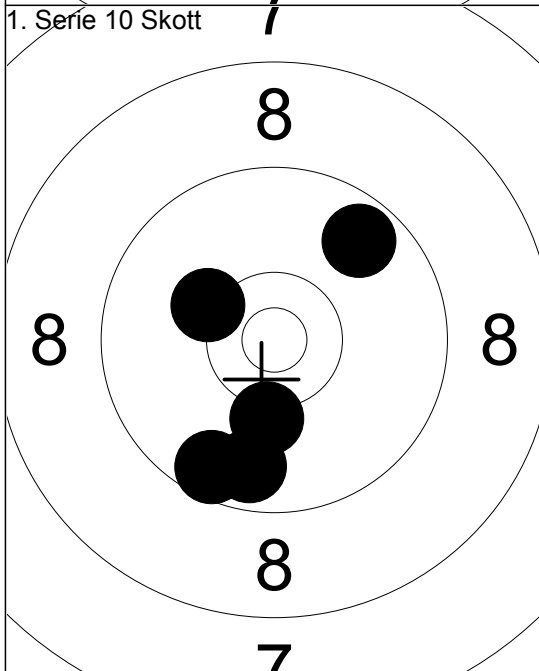

1:	9.7	↗
2:	9.7	↓
3:	9.6	↓
4:	10.2	↖
5:	10.2	↓
Serie		47.0
Total		235.0

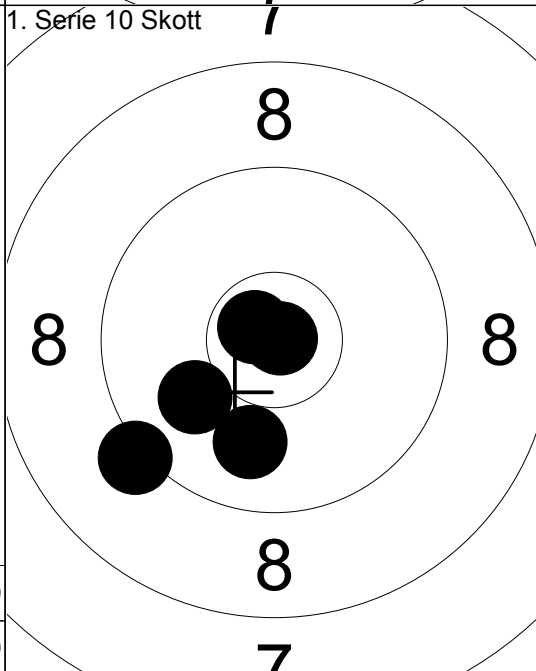

6:	10.0	↖
7:	9.9	↓
8:	9.2	↖
9:	*10.7	↖
10:	*10.9	→
Serie		48.0
Total		283.0

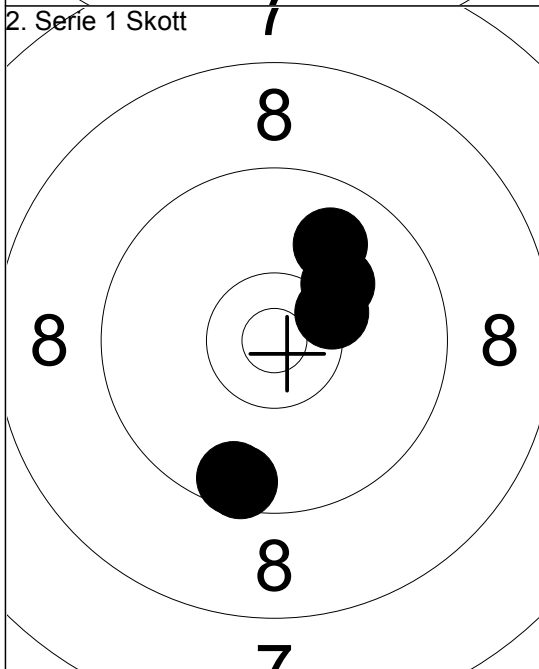

1:	*10.3	↗
2:	9.9	↗
3:	9.6	↓
4:	10.1	↗
5:	9.6	↓
Serie		47.0
Total		330.0

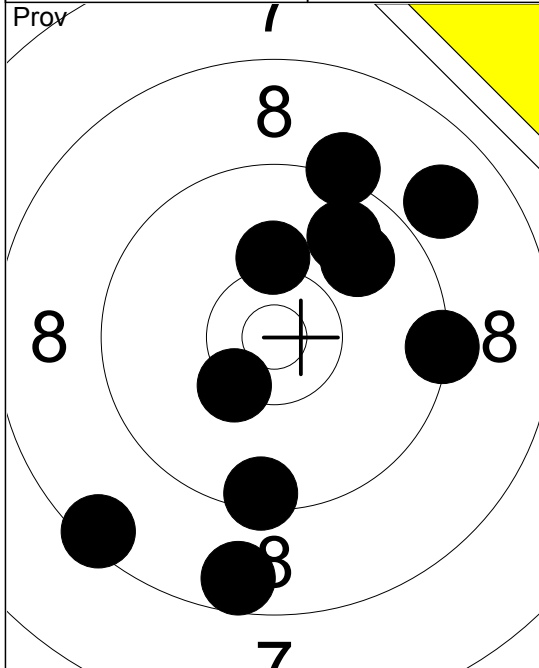

- 1: 8.9 ↗
- 2: 10.2 ↑
- 3: 9.8 ↗
- 4: 9.9 ↗
- 5: 9.2 ↑
- 6: 8.4 ↙
- 7: 8.6 ↓
- 8: 9.5 ↓
- 9: *10.4 ↙
- 10: 9.3 →

Serie	89.0
Total	185.0

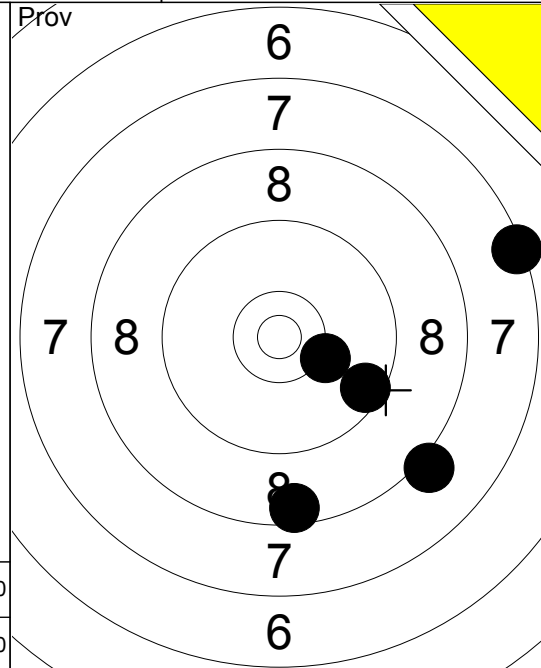

- 11: 8.5 ↓
- 12: 9.5 ↘
- 13: 7.4 →
- 14: 10.2 ↘
- 15: 8.2 ↘

Serie	42.0
Total	185.0

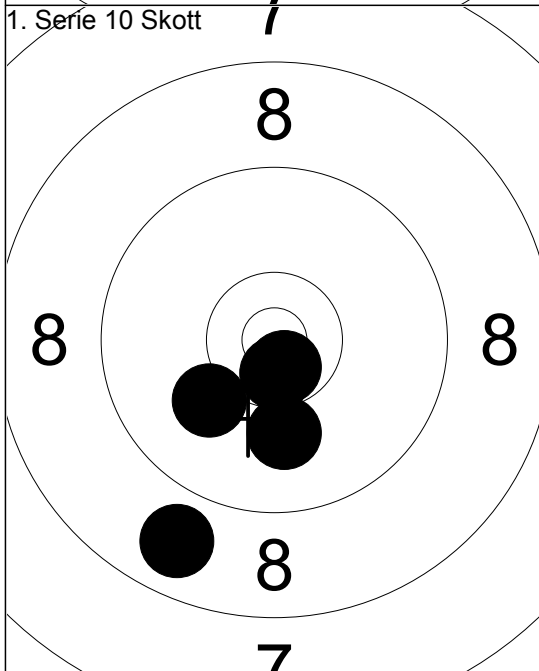

- 1: *10.6 ↓
- 2: 8.8 ↘
- 3: *10.7 ↘
- 4: 10.1 ↓
- 5: 10.1 ↙

Serie	48.0
Total	233.0

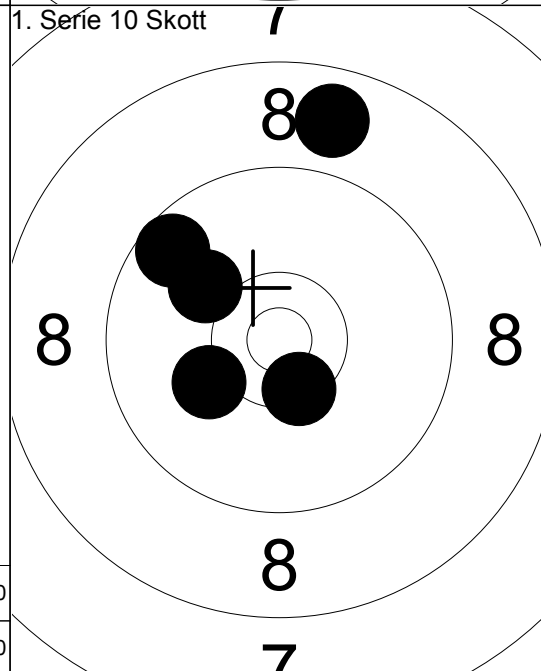

- 6: 10.1 ↖
- 7: 9.6 ↖
- 8: *10.4 ↓
- 9: 10.2 ↖
- 10: 8.8 ↑

Serie	47.0
Total	280.0

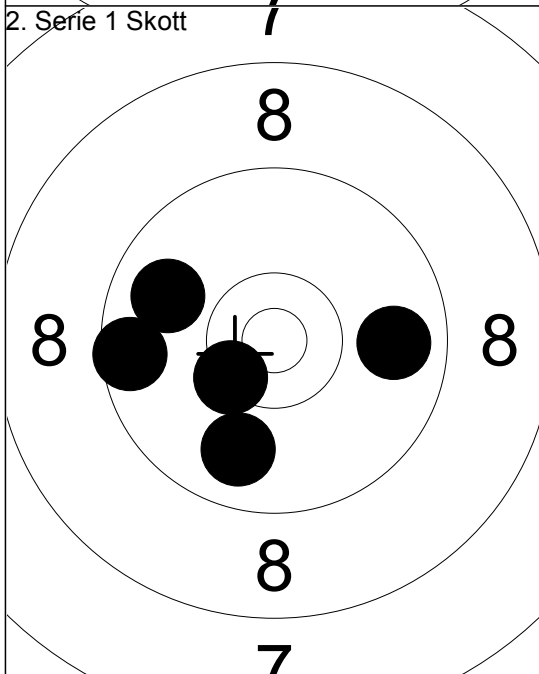

- 1: 9.8 ←
- 2: *10.4 ↙
- 3: 9.8 →
- 4: 9.6 ←
- 5: 9.9 ↓

Serie	46.0
Total	326.0

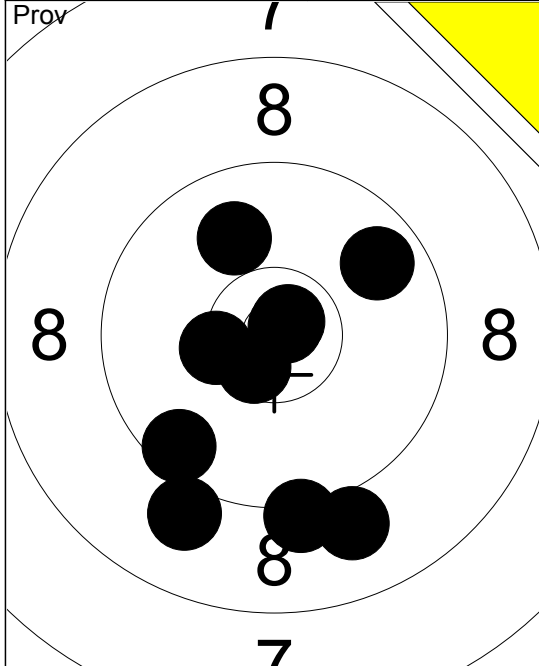

1:	9.2	↓
2:	*10.6	↙
3:	9.0	↙
4:	9.0	↙
5:	*10.8	↗
6:	10.0	↑
7:	9.8	↗
8:	*10.8	↗
9:	*10.4	←
10:	9.6	↙
Serie		95.0
Total		183.0

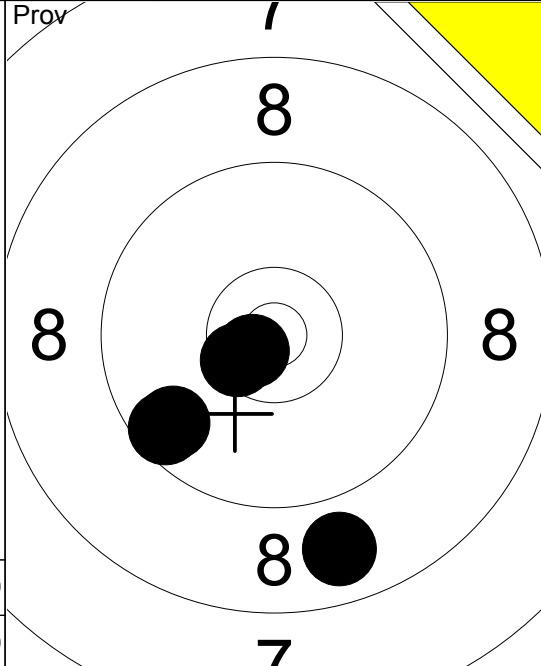

11:	*10.7	↙
12:	8.8	↓
13:	*10.5	↙
14:	9.7	↙
15:	9.6	↙
Serie		46.0
Total		183.0

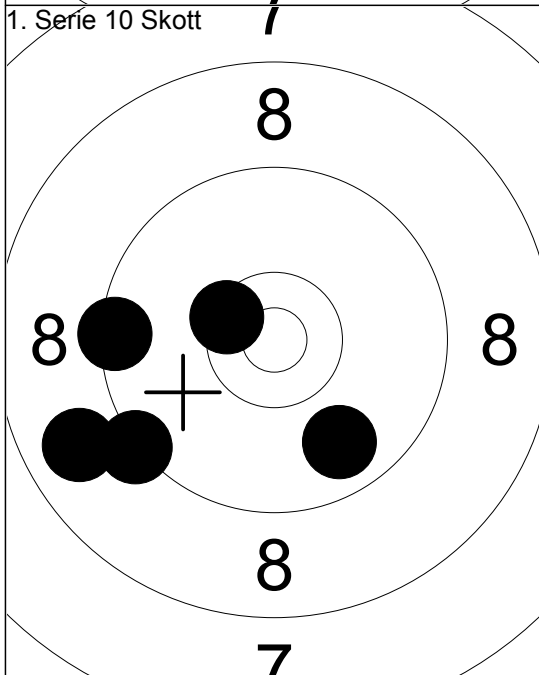

1:	9.8	↓
2:	8.8	←
3:	*10.4	↙
4:	9.3	←
5:	9.4	←
Serie		45.0
Total		228.0

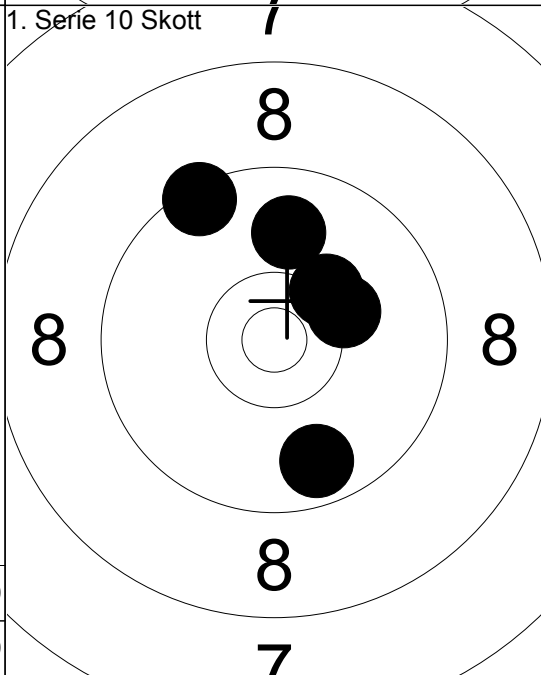

6:	9.4	↗
7:	9.7	↓
8:	10.2	↗
9:	10.3	↗
10:	9.9	↑
Serie		47.0
Total		275.0

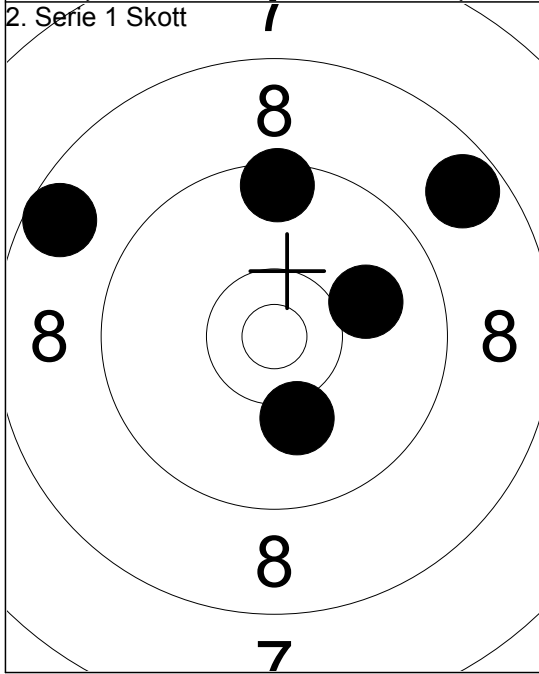

1:	10.1	↓
2:	8.7	↗
3:	9.5	↑
4:	10.0	↗
5:	8.6	↙
Serie		45.0
Total		320.0

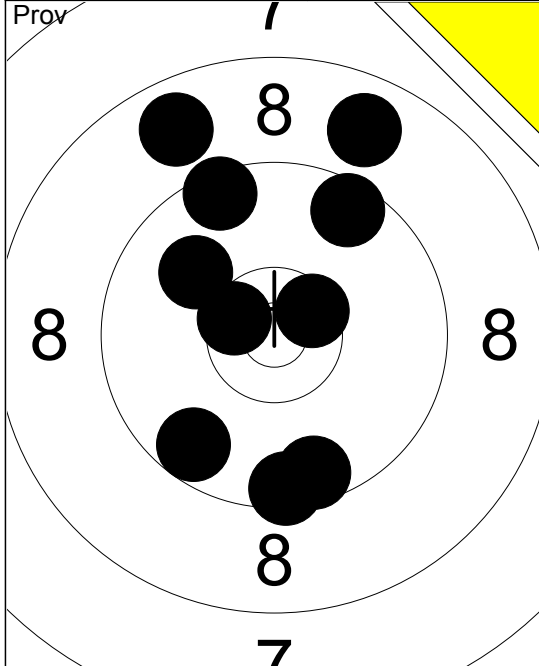

1:	9.7	↙
2:	9.6	↓
3:	9.5	↓
4:	10.0	↗
5:	*10.5	↖
6:	9.6	↗
7:	9.5	↗
8:	8.8	↗
9:	*10.5	↗
10:	8.8	↗
Serie		91.0
Total		181.0

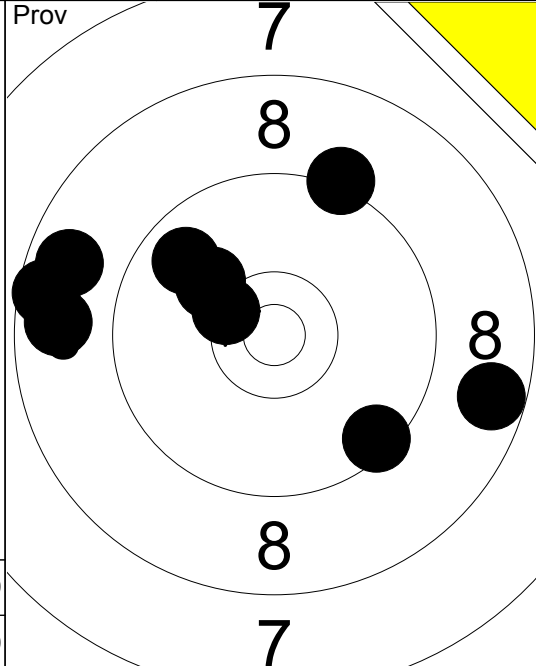

11:	10.1	↗
12:	*10.4	↖
13:	8.6	↖
14:	8.6	↘
15:	9.5	↘
16:	9.8	↗
17:	8.7	↖
18:	10.1	↗
19:	8.7	↖
20:	9.2	↗
Serie		89.0
Total		181.0

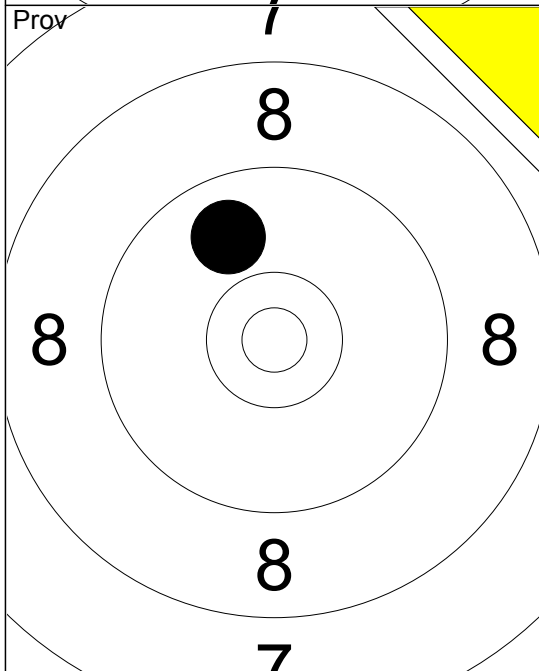

21:	9.9	↗
Serie		9.0
Total		181.0

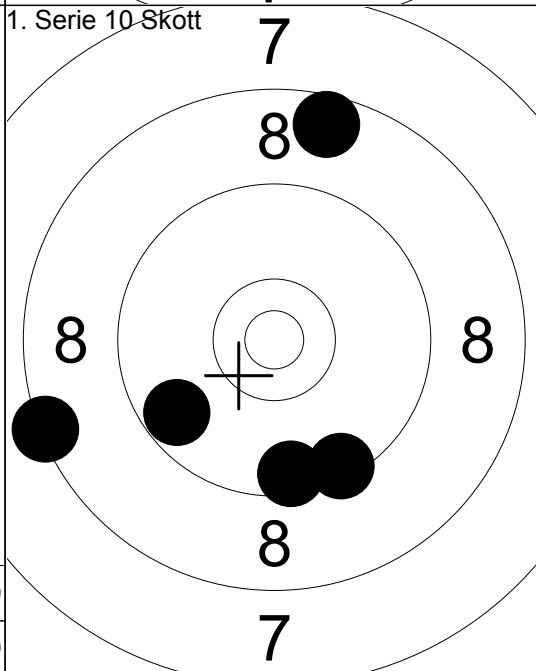

1:	8.4	↖
2:	9.5	↓
3:	9.7	↖
4:	8.6	↗
5:	9.4	↘
Serie		43.0
Total		224.0

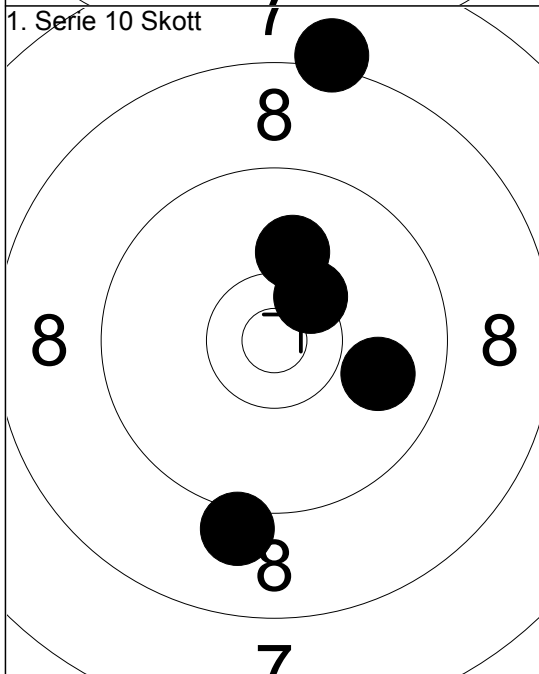

6:	8.2	↗
7:	9.9	→
8:	*10.4	↗
9:	10.1	↗
10:	9.1	↓
Serie		46.0
Total		270.0

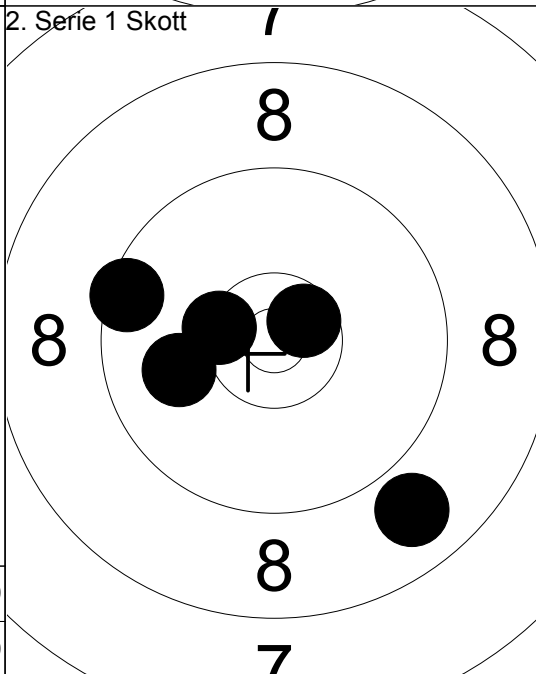

1:	10.0	↖
2:	8.9	↘
3:	*10.4	↖
4:	*10.6	↗
5:	9.5	↖
Serie		47.0
Total		317.0

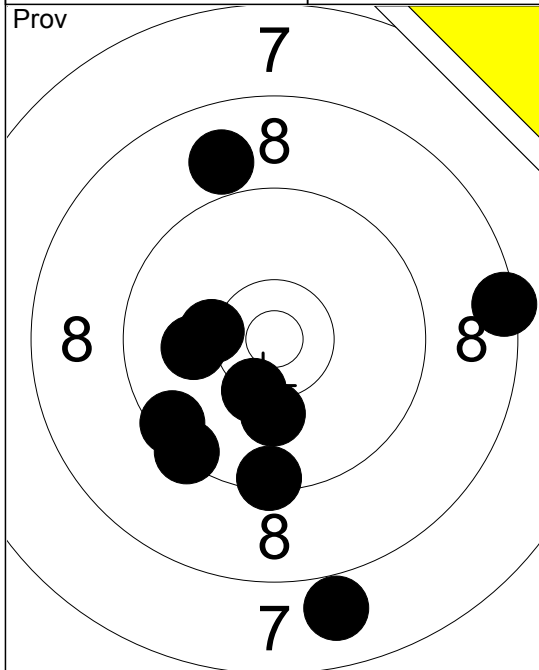

- 1: 10.1 ←
- 2: 10.1 ↓
- 3: 9.4 ↓
- 4: 10.3 ←
- 5: 9.4 ↙
- 6: 8.4 →
- 7: 7.9 ↓
- 8: *10.3 ↓
- 9: 9.5 ↙
- 10: 8.9 ↗

Serie 90.0

Total 178.0

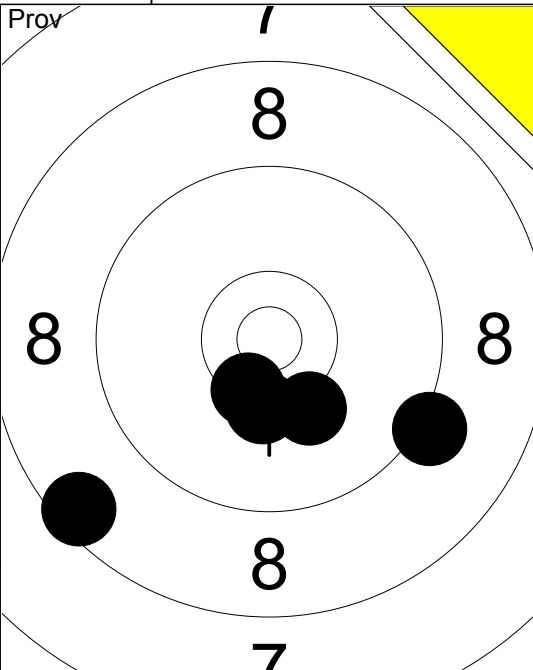

- 11: 8.5 ↙
- 12: *10.4 ↓
- 13: *10.3 ↓
- 14: 9.2 ↗
- 15: 10.2 ↓

Serie 47.0

Total 178.0

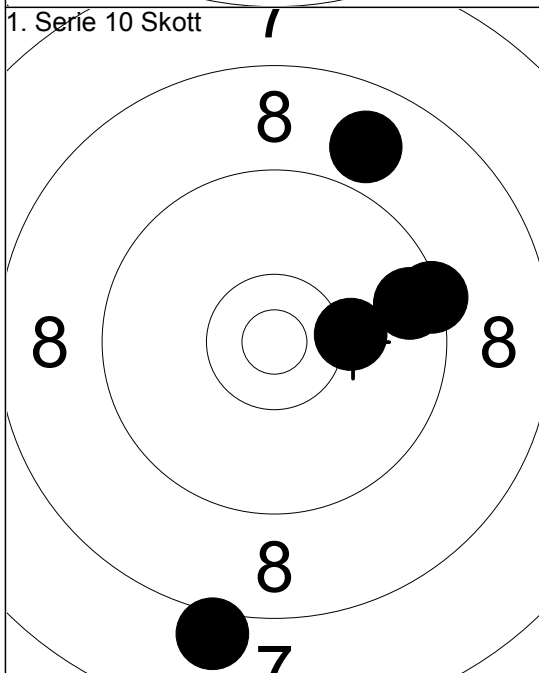

- 1: 9.6 →
- 2: 8.1 ↓
- 3: 10.2 →
- 4: 8.9 ↗
- 5: 9.4 →

Serie 44.0

Total 222.0

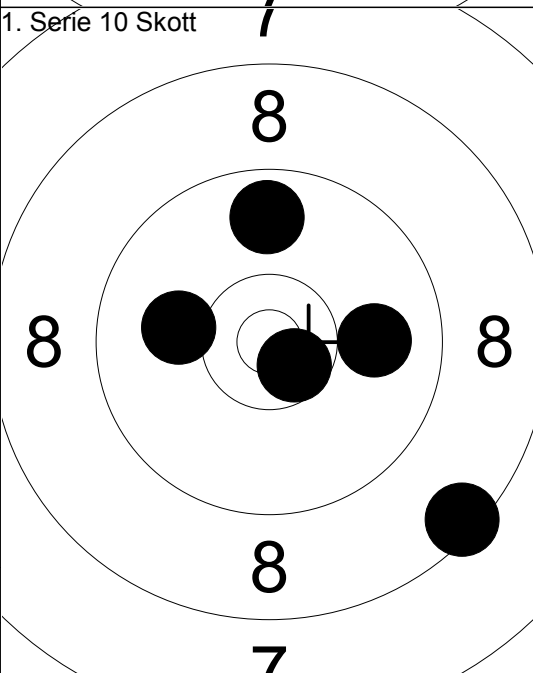

- 6: 10.1 ←
- 7: 9.8 ↑
- 8: *10.6 ↓
- 9: 9.9 →
- 10: 8.5 ↓

Serie 46.0

Total 268.0

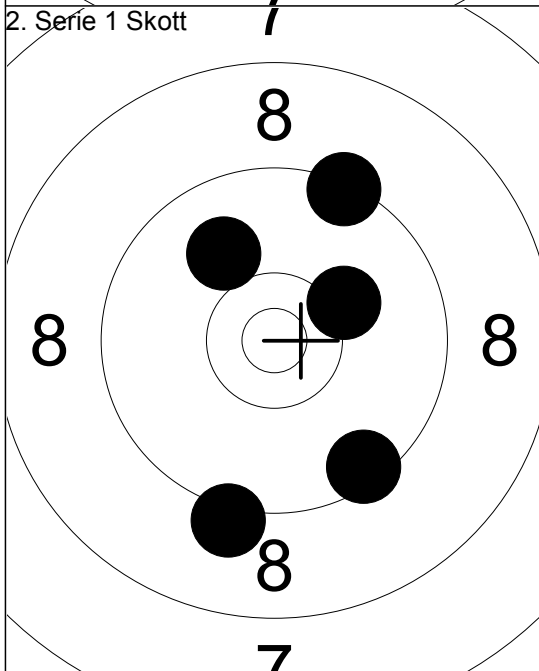

- 1: 9.2 ↓
- 2: 9.5 ↓
- 3: 10.0 ↗
- 4: 9.4 ↗
- 5: 10.2 ↗

Serie 47.0

Total 315.0

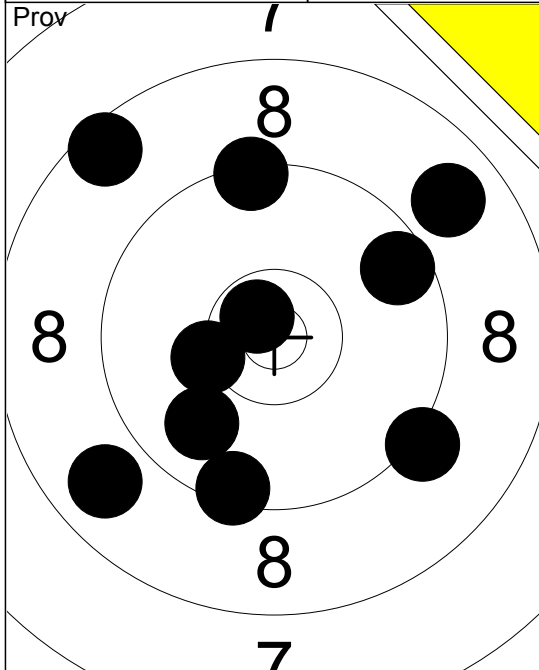

1:	8.8	↙
2:	8.5	↗
3:	*10.3	↖
4:	*10.7	↗
5:	8.8	↗
6:	9.5	↘
7:	9.6	↗
8:	9.2	↘
9:	9.9	↙
10:	9.4	↑
Serie	89.0	
Total	175.0	

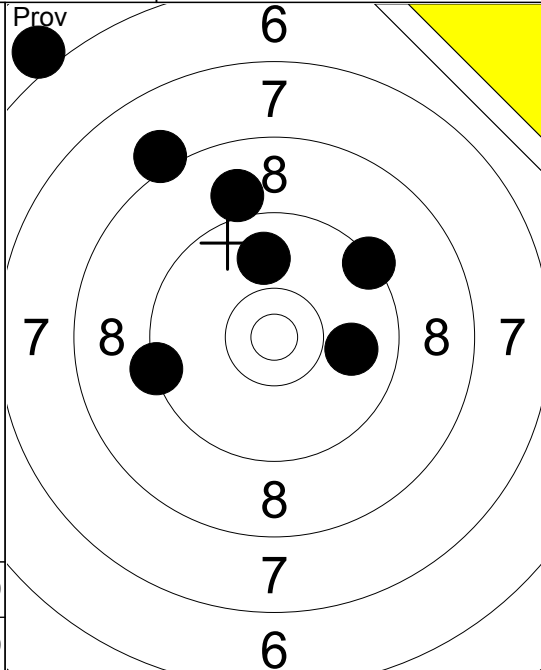

11:	6.1	↖
12:	9.0	↑
13:	9.9	↑
14:	9.9	→
15:	9.4	↗
16:	9.3	↖
17:	8.1	↗
Serie	59.0	
Total	175.0	

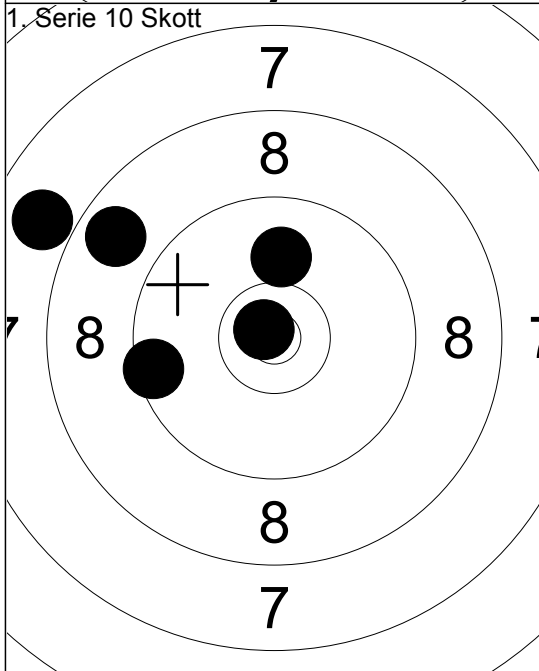

1:	10.0	↑
2:	7.9	↖
3:	9.5	↖
4:	8.8	↖
5:	*10.8	↗
Serie	44.0	
Total	219.0	

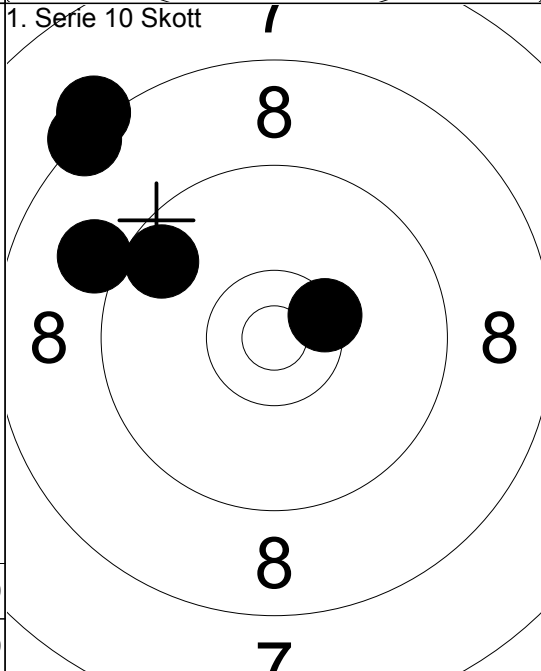

6:	9.6	↖
7:	8.3	↗
8:	*10.4	↗
9:	8.2	↗
10:	9.1	↖
Serie	44.0	
Total	263.0	

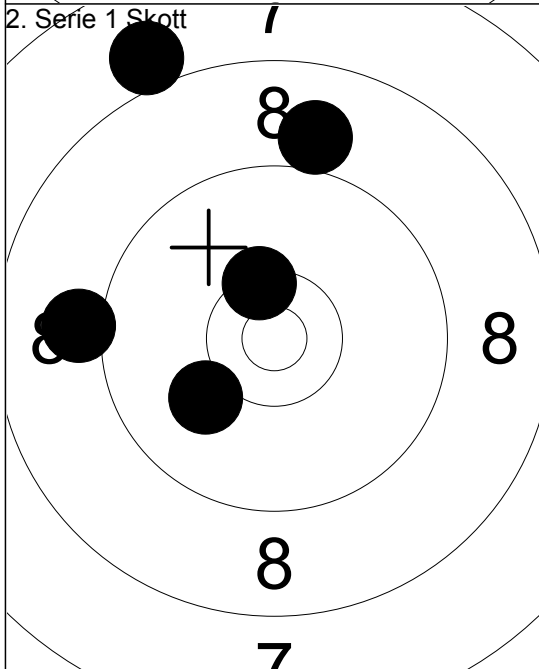

1:	9.0	↑
2:	*10.4	↑
3:	9.1	↖
4:	10.1	↖
5:	8.0	↗
Serie	46.0	
Total	309.0	

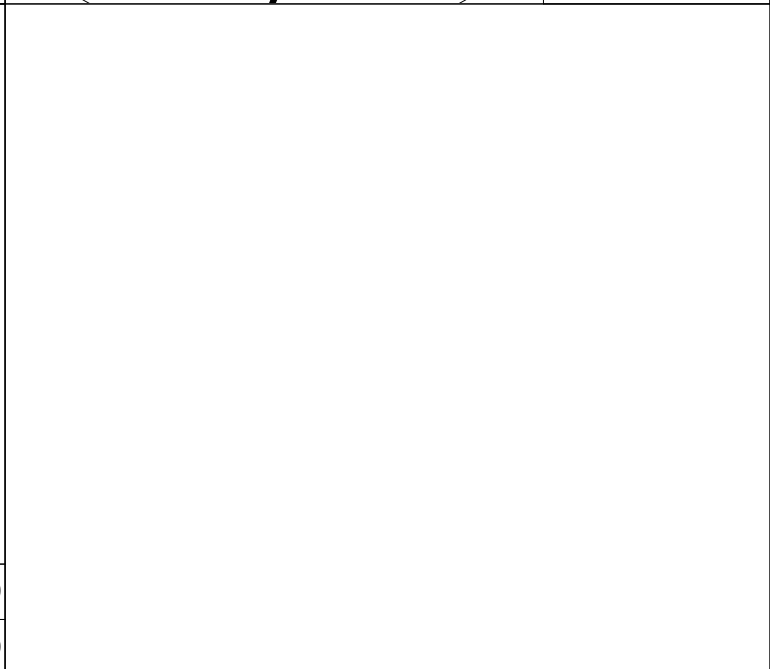

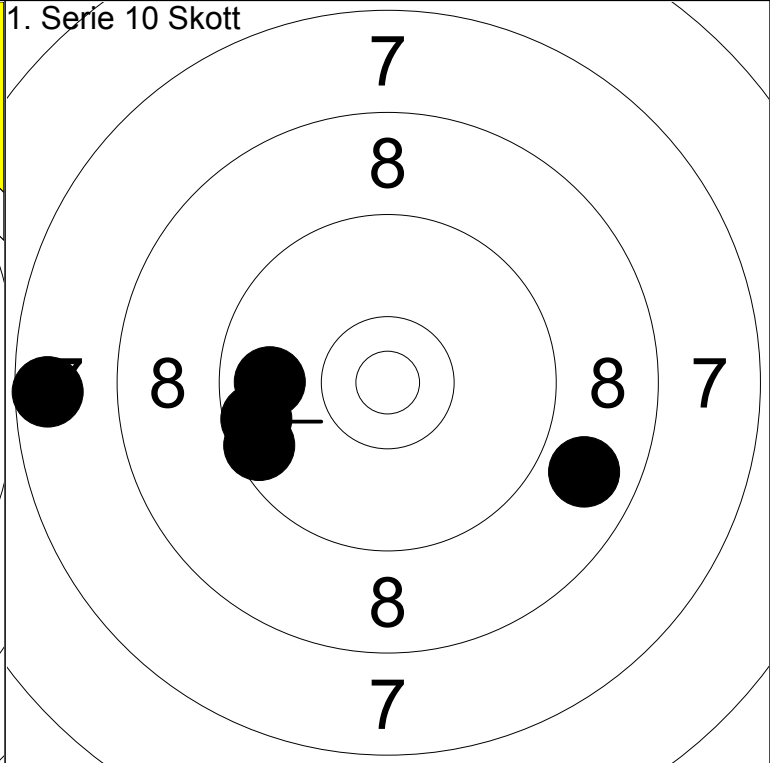
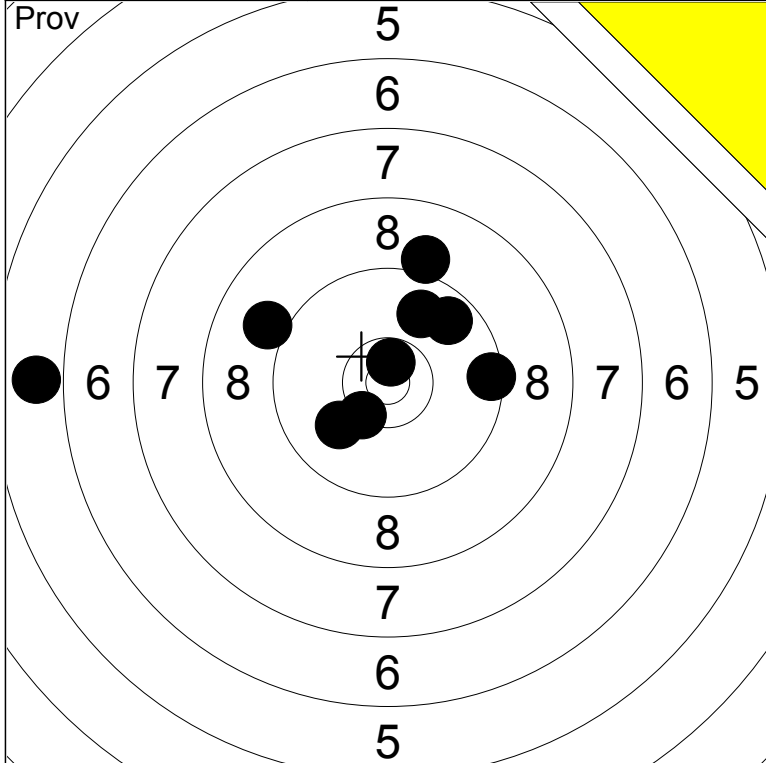

1: *10.4 ↙	6: 10.0 ↙	Serie	80.0
2: 9.1 ↑	7: 9.7 ↗		
3: 9.5 →	8: 9.0 ↖	Total	197.0
4: 9.9 ↗	9: 5.9 ←		
5: *10.7 ↑			

1: 7.6 ←	Serie	42.0
2: 9.6 ←		
3: 9.8 ←	Total	239.0
4: 9.5 ←		
5: 8.8 ↘		

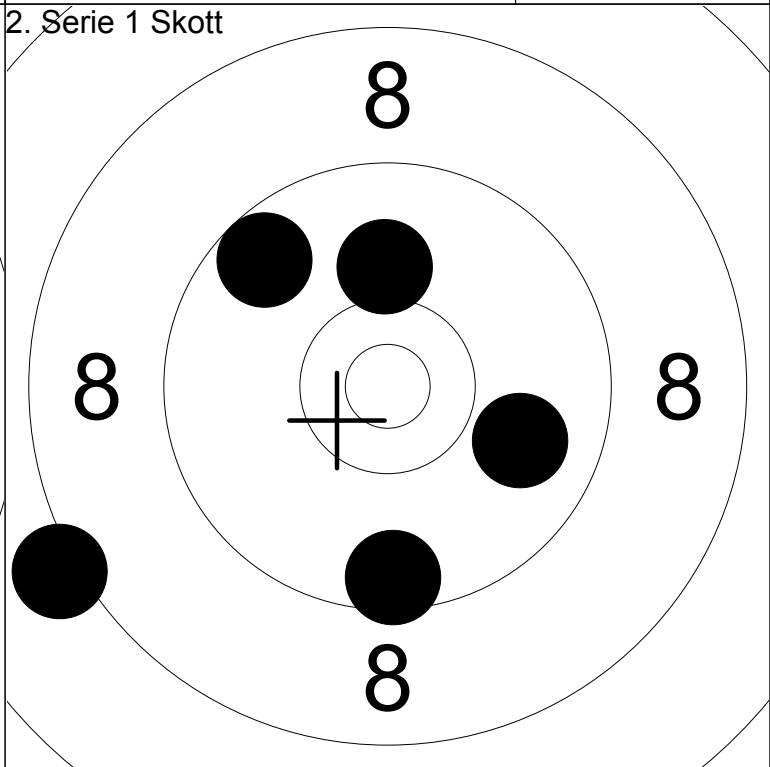
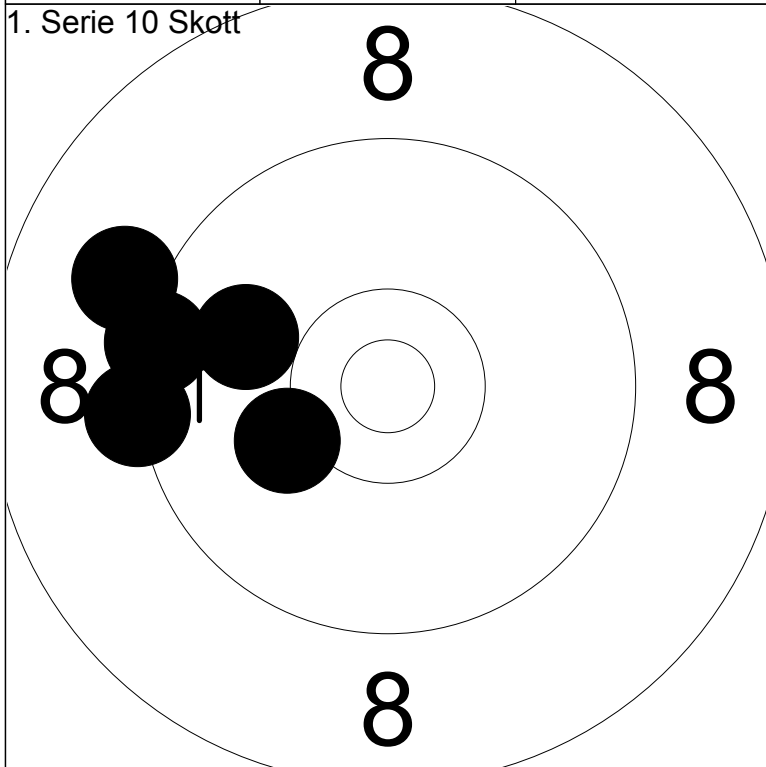

6: 9.9 ←	Serie	46.0
7: 9.4 ←		
8: 9.1 ←	Total	285.0
9: 10.2 ←		
10: 9.3 ←		

1: 9.9 →	Serie	45.0
2: 9.6 ↗		
3: 10.1 ↑	Total	330.0
4: 8.2 ↖		
5: 9.5 ↓		

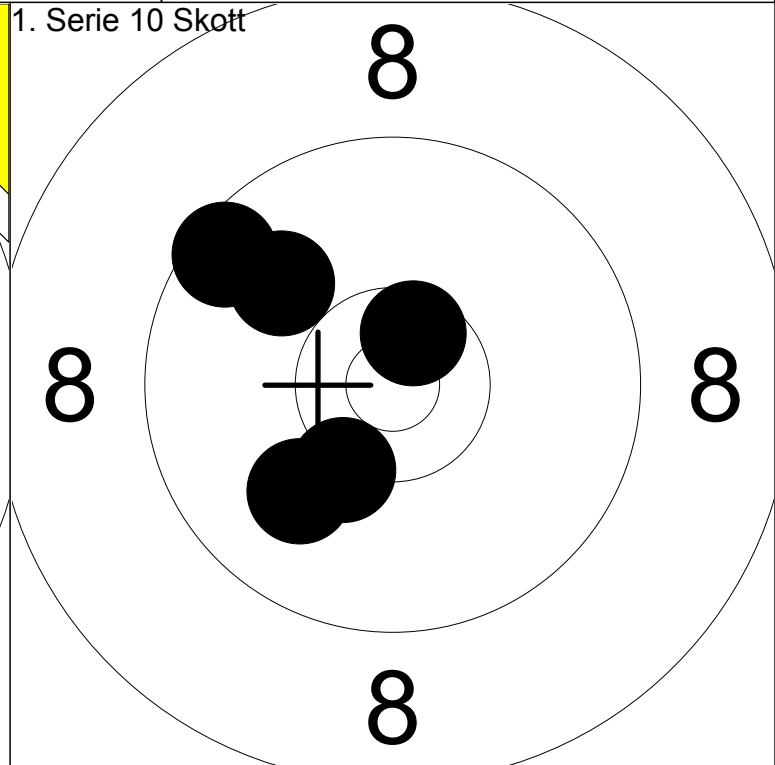
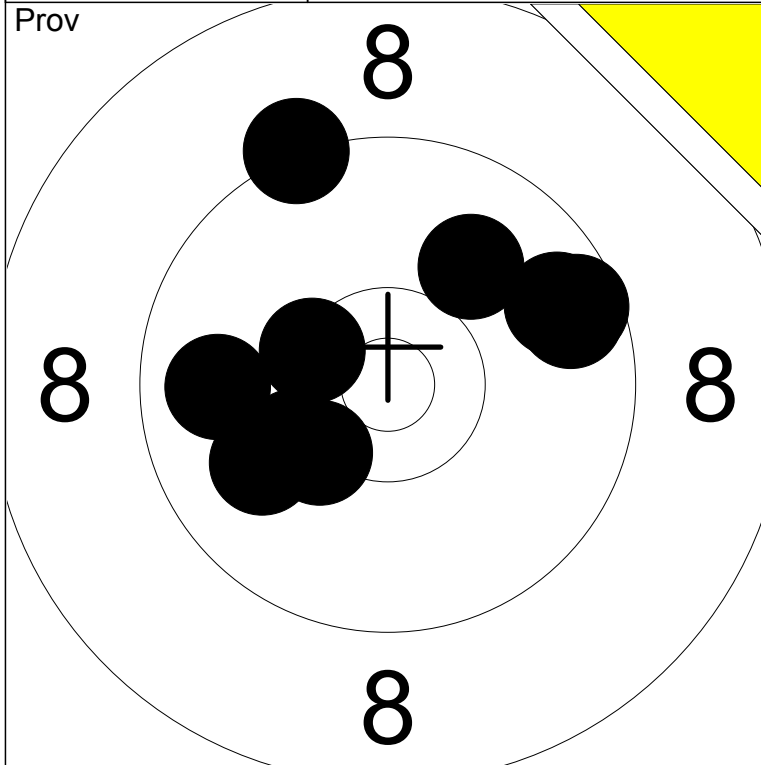

1: 9.3 ↗	6: 9.7 ↘	Serie	95.0
2: 10.0 ↖	7: *10.4 ↖		
3: 10.2 ↖	8: 10.0 ↗	Total	194.0
4: 9.8 ←	9: 9.6 ↘		
5: 9.7 →	10: *10.3 ↖		

1: 9.5 ↖	Serie	48.0
2: *10.6 ↗		
3: *10.3 ↘	Total	242.0
4: 9.9 ↖		
5: 10.0 ↘		

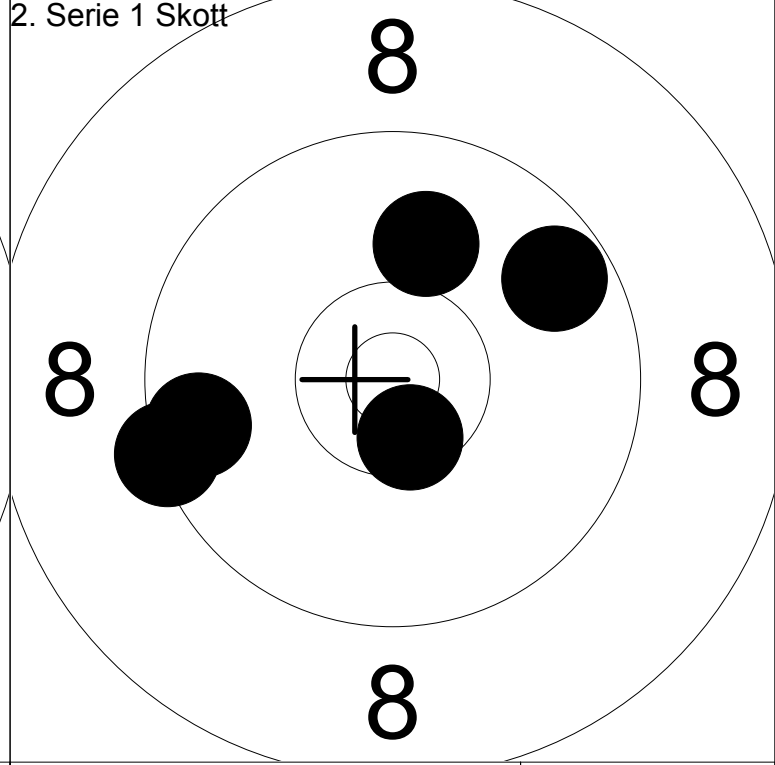
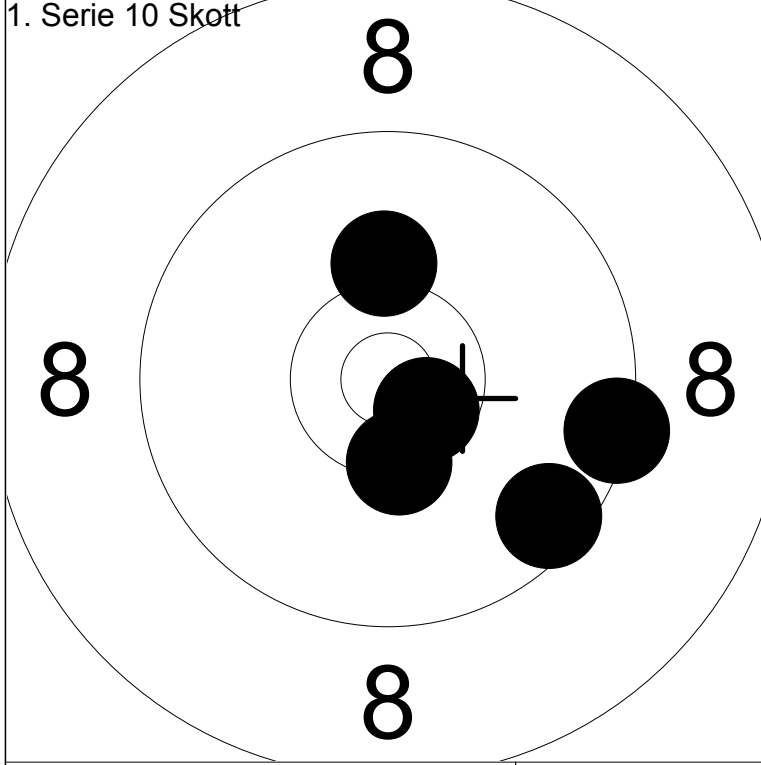

6: 10.2 ↑	Serie	48.0
7: 9.4 →		
8: 9.5 ↘	Total	290.0
9: *10.6 ↘		
10: *10.4 ↓		

1: 9.7 ↘	Serie	47.0
2: 9.6 ←		
3: 10.0 ↑	Total	337.0
4: 9.4 ←		
5: *10.5 ↓		

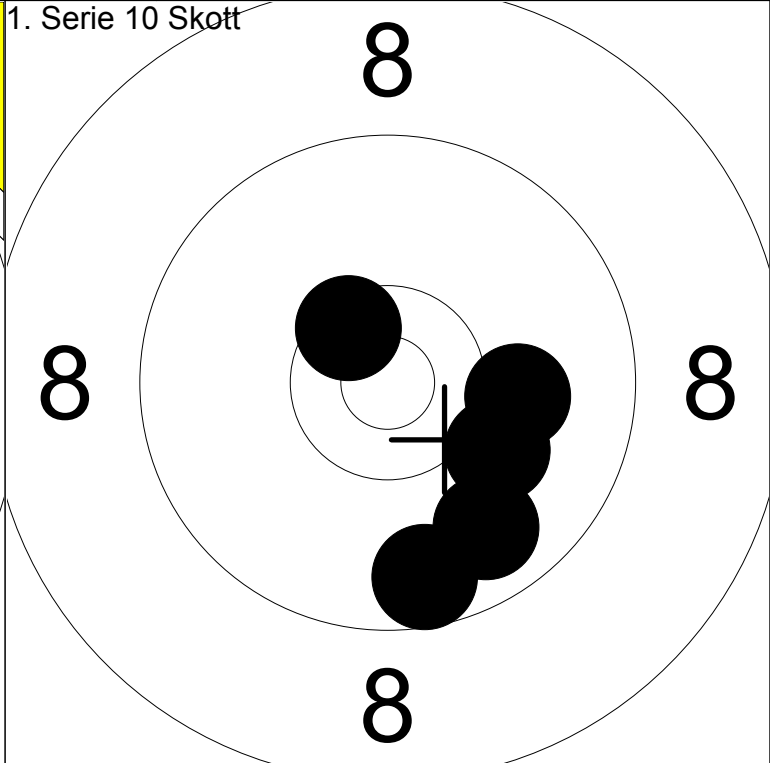
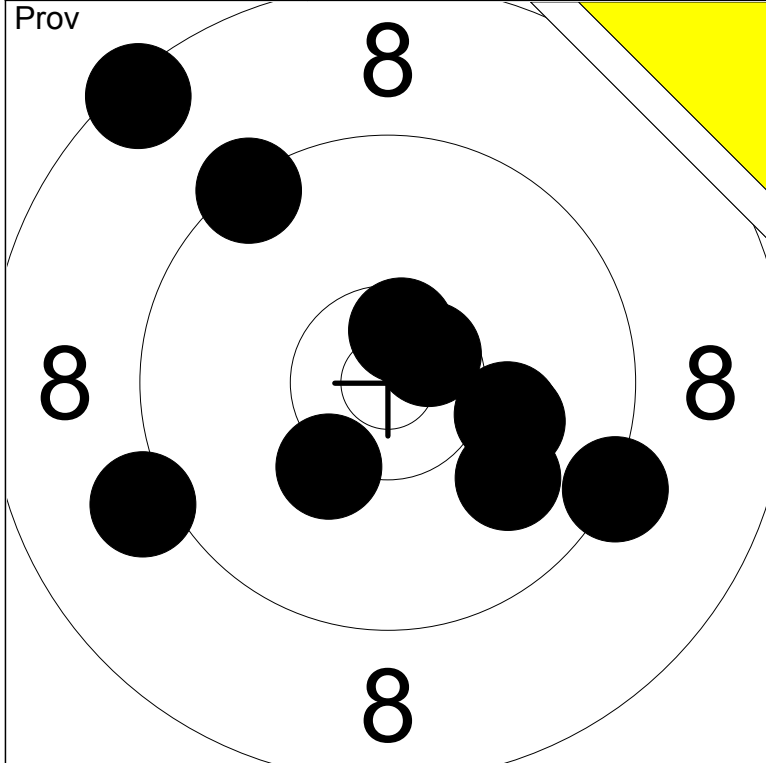

1: 8.4 ↗	6: 10.3 ↘	Serie	94.0
2: 9.4 ↗	7: 9.9 ↘		
3: *10.6 ↗	8: 10.1 →	Total	194.0
4: 10.1 →	9: 9.1 ←		
5: 9.3 ↘	10: *10.6 ↗		

1: 10.1 →	Serie	48.0
2: 10.1 ↘		
3: *10.5 ↗	Total	242.0
4: 9.6 ↘		
5: 9.8 ↘		

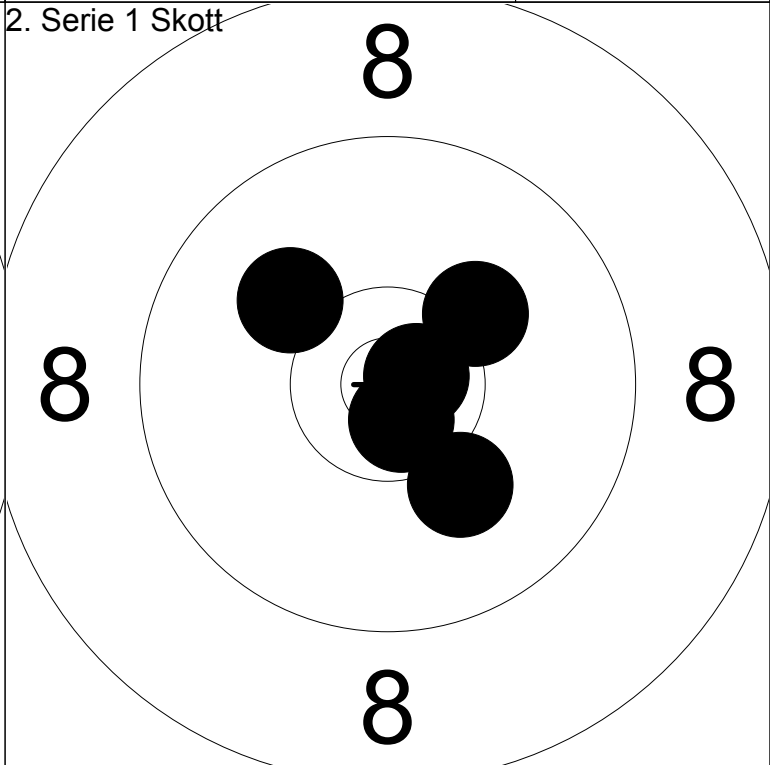
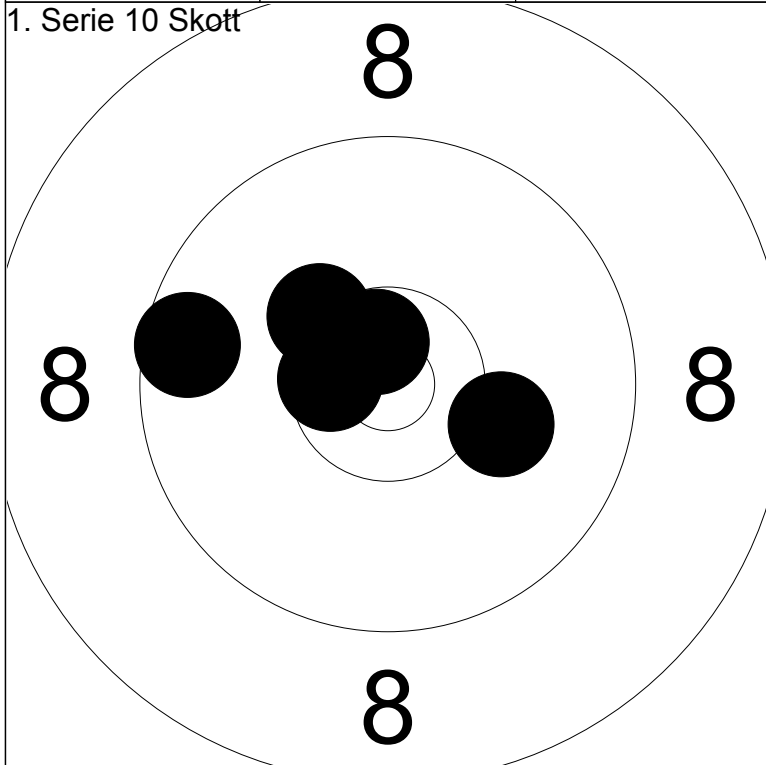

6: *10.3 ↗	Serie	49.0
7: 9.6 ←		
8: 10.2 →	Total	291.0
9: *10.7 ↗		
10: *10.6 ←		

1: 10.2 ↗	Serie	50.0
2: *10.7 ↘		
3: 10.1 ↗	Total	341.0
4: 10.1 ↘		
5: *10.8 →		

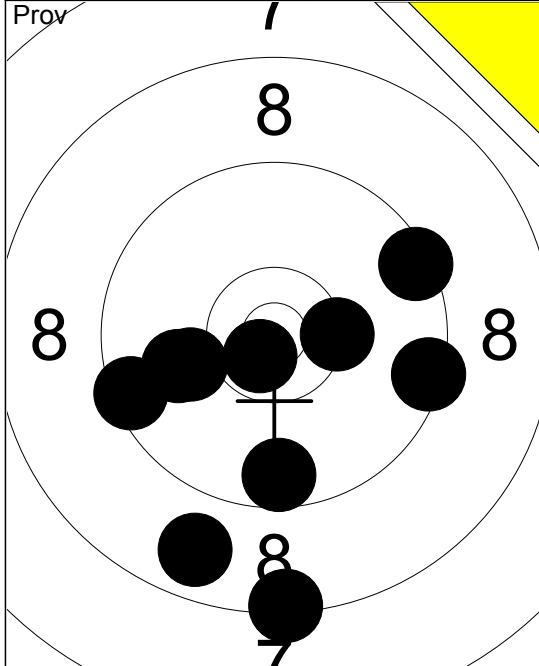

1:	10.0	←
2:	9.4	→
3:	8.4	↓
4:	9.5	←
5:	9.6	↓
6:	*10.4	→
7:	10.1	←
8:	*10.7	↙
9:	9.4	↗
10:	8.8	↘
Serie		92.0
Total		190.0

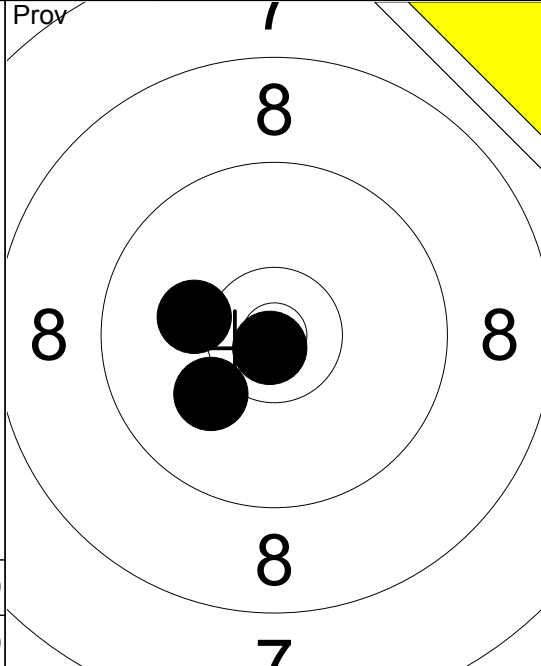

11:	10.1	↙
12:	10.2	←
13:	*10.8	↘
Serie		30.0
Total		190.0

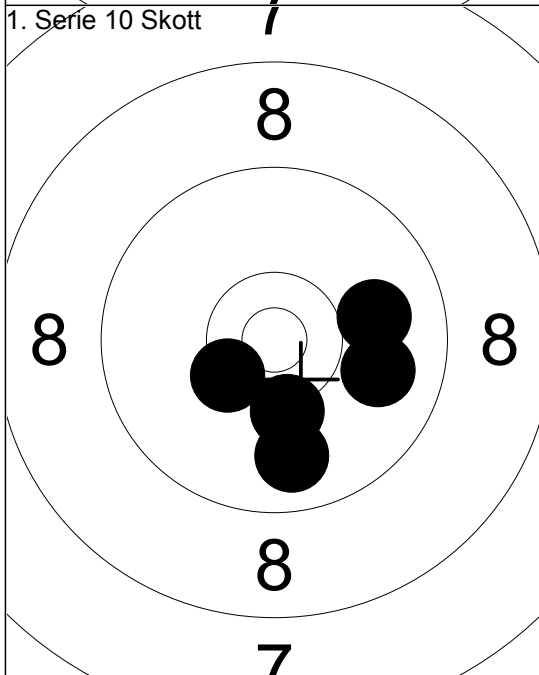

1. Serie 10 Skott		
1:	9.8	↓
2:	*10.4	↙
3:	10.3	↓
4:	9.9	→
5:	10.0	→
Serie		48.0
Total		238.0

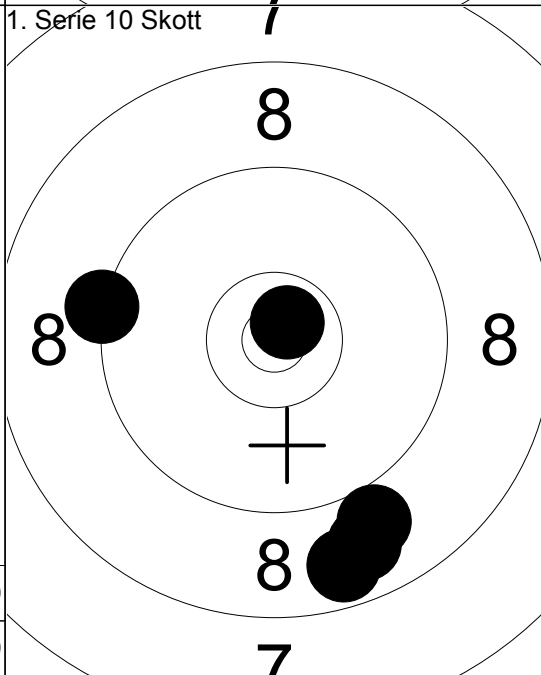

1. Serie 10 Skott		
6:	8.7	↘
7:	*10.7	↗
8:	8.8	↘
9:	9.0	↘
10:	9.3	←
Serie		44.0
Total		282.0

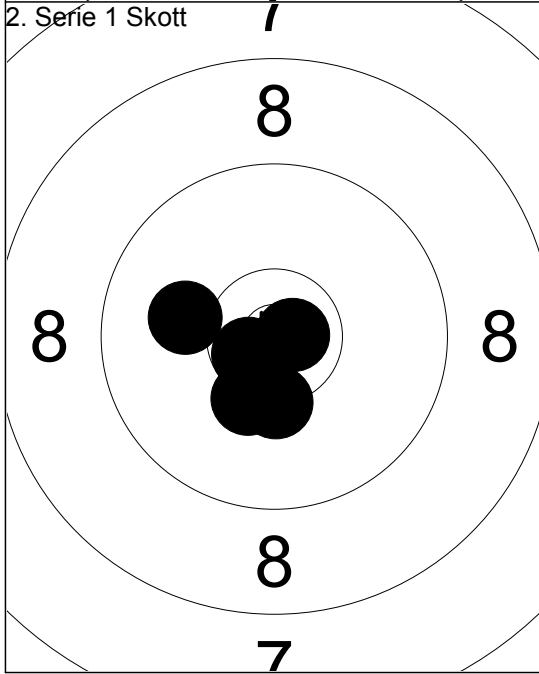

2. Serie 1 Skott		
1:	*10.3	↓
2:	*10.3	↘
3:	10.1	←
4:	*10.8	→
5:	*10.7	↙
Serie		50.0
Total		332.0

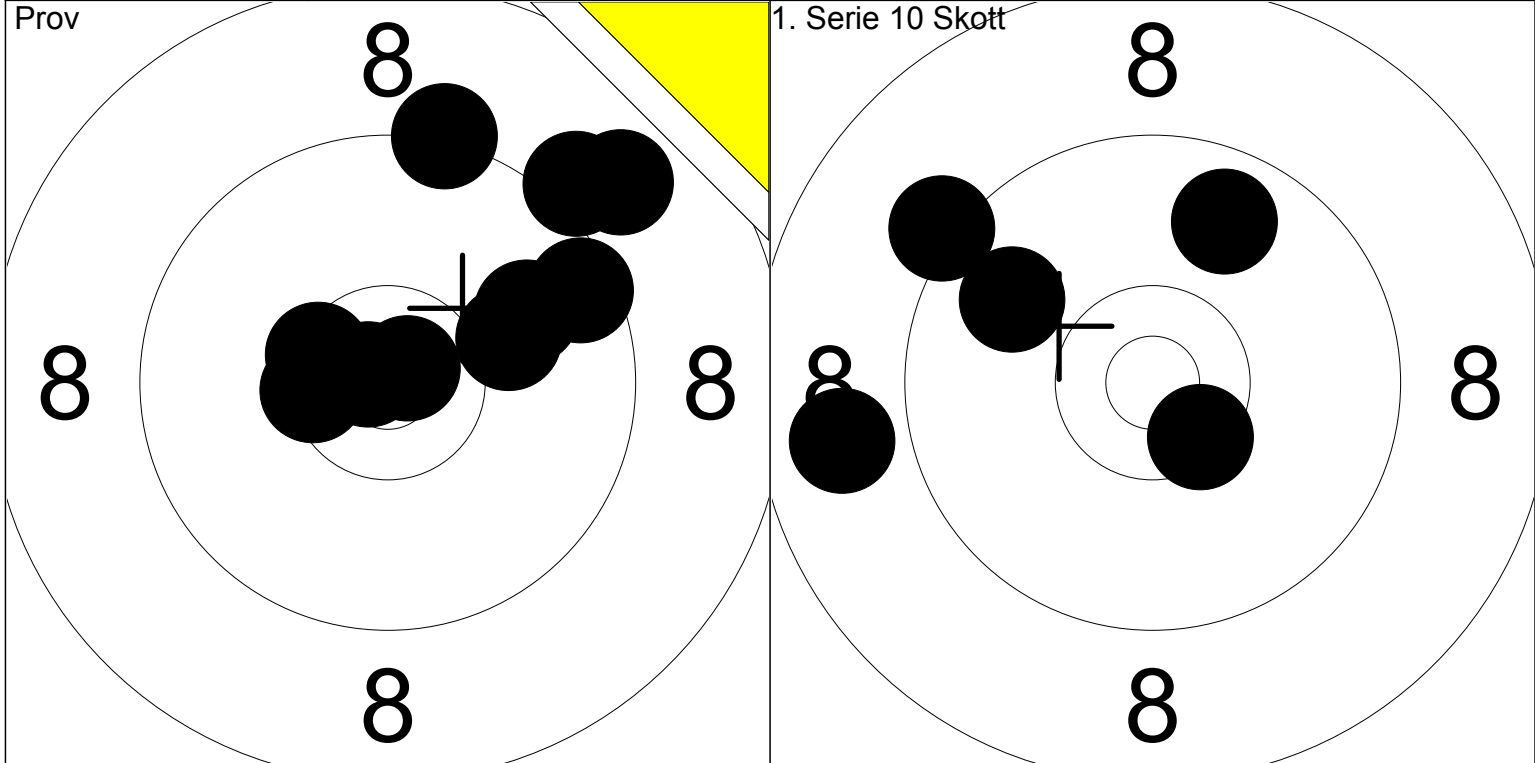

1: 9.9 →	6: 8.9 ↗	Serie 94.0	1: 9.8 ↗	Serie 45.0
2: 9.3 ↑	7: 9.5 →		2: 8.8 ←	
3: *10.8 ←	8: 10.1 →	Total 189.0	3: 9.9 ↗	Total 234.0
4: *10.8 ↗	9: *10.5 ←		4: 9.2 ↗	
5: 9.1 ↗	10: *10.5 ←		5: *10.5 ↘	

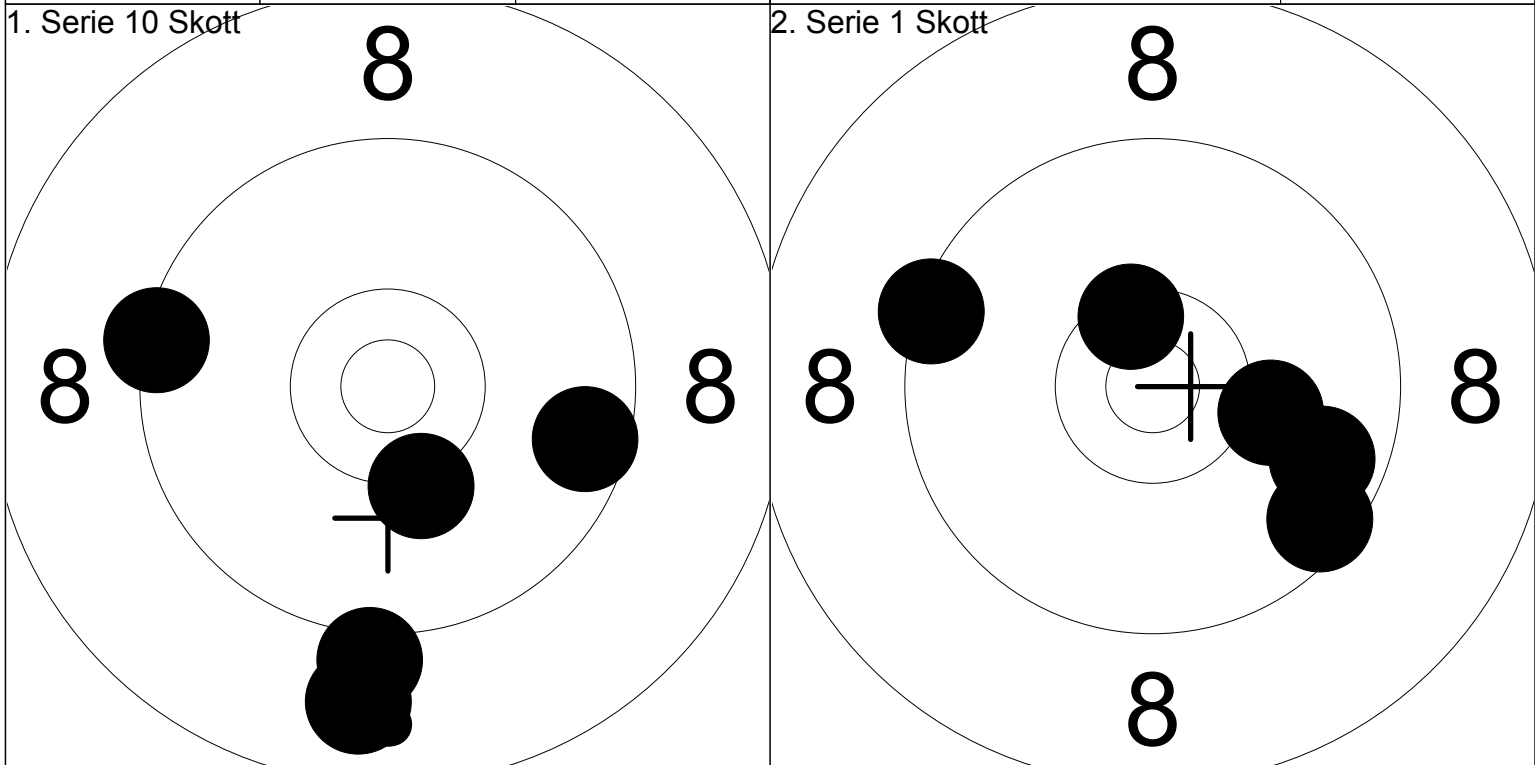

6: 9.6 →	Serie 45.0	1: 9.4 ←	Serie 47.0
7: 9.4 ←		2: 10.1 →	
8: 8.8 ↓	Total 279.0	3: *10.5 ↗	Total 326.0
9: 9.1 ↓		4: 9.7 ↘	
10: 10.2 ↓		5: 9.5 ↘	

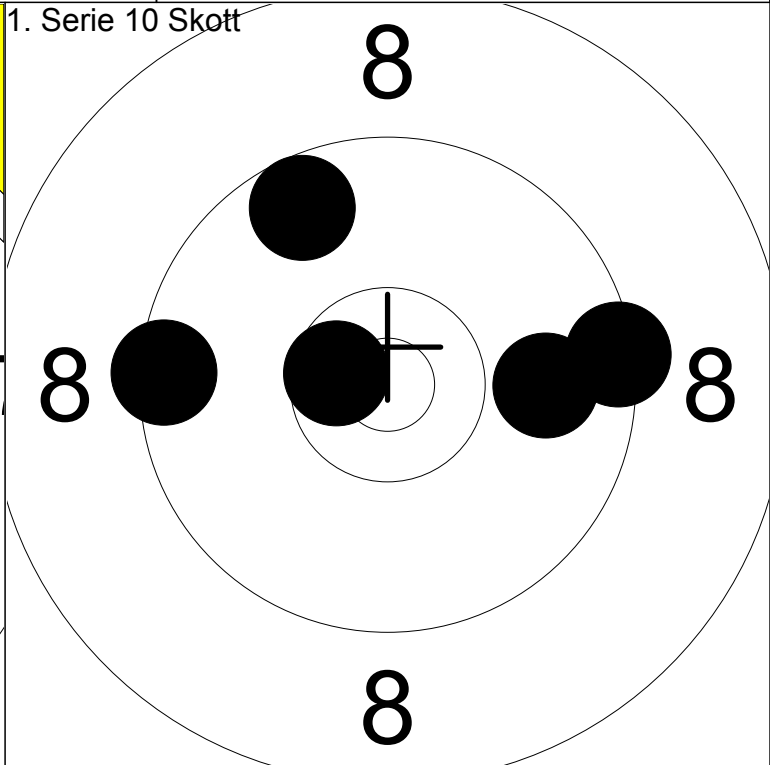
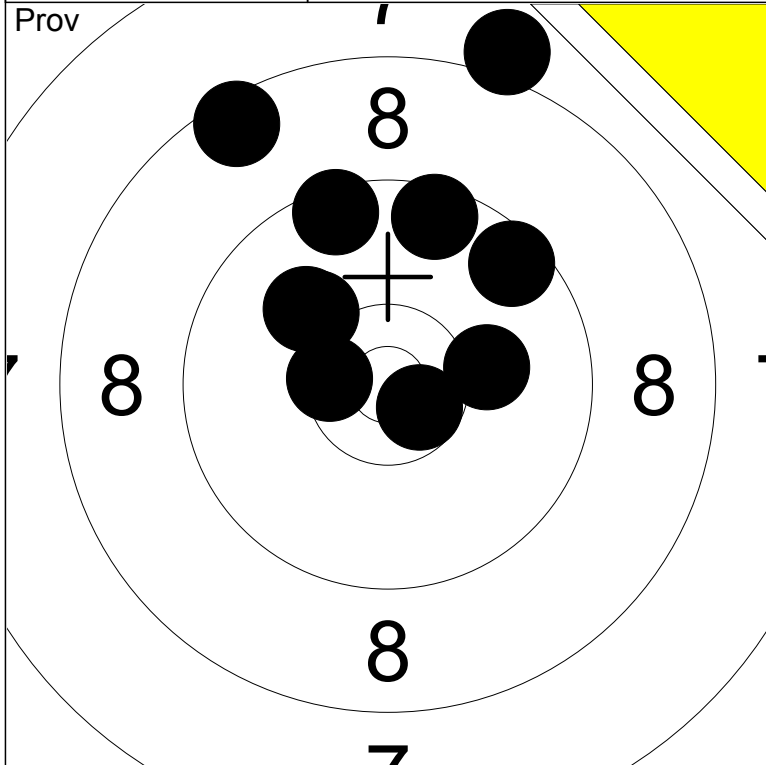

1: 8.5 ↗	6: *10.6 ↘	Serie	93.0
2: 9.5 ↑	7: 9.5 ↑		
3: 10.1 →	8: 10.1 ↗	Total	189.0
4: 8.1 ↑	9: *10.5 ←		
5: 9.6 ↗	10: 10.1 ↗		

1: 9.5 ←	Serie	46.0
2: 9.6 ↗		
3: *10.6 ←	Total	235.0
4: 9.4 →		
5: 9.9 →		

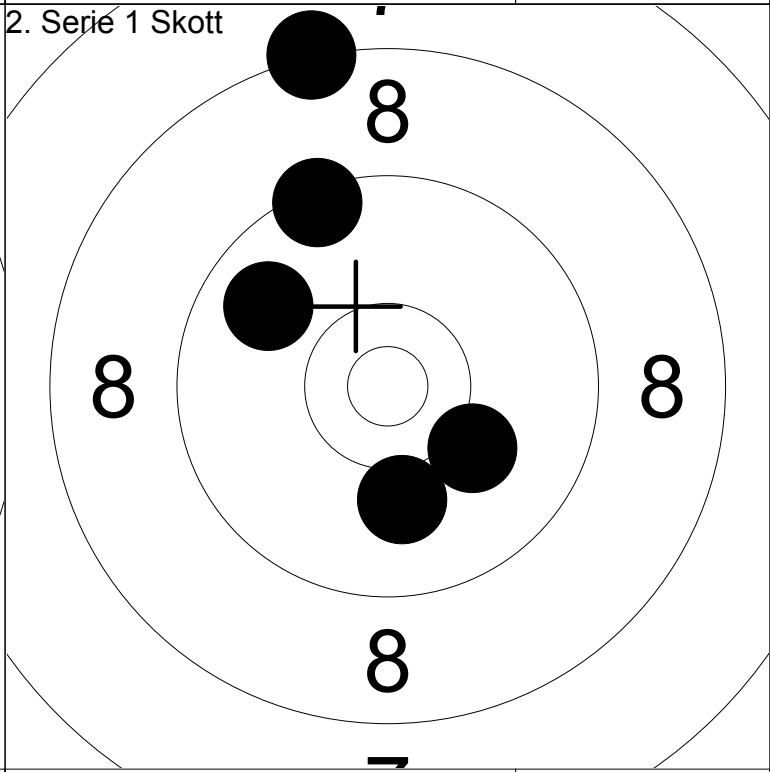
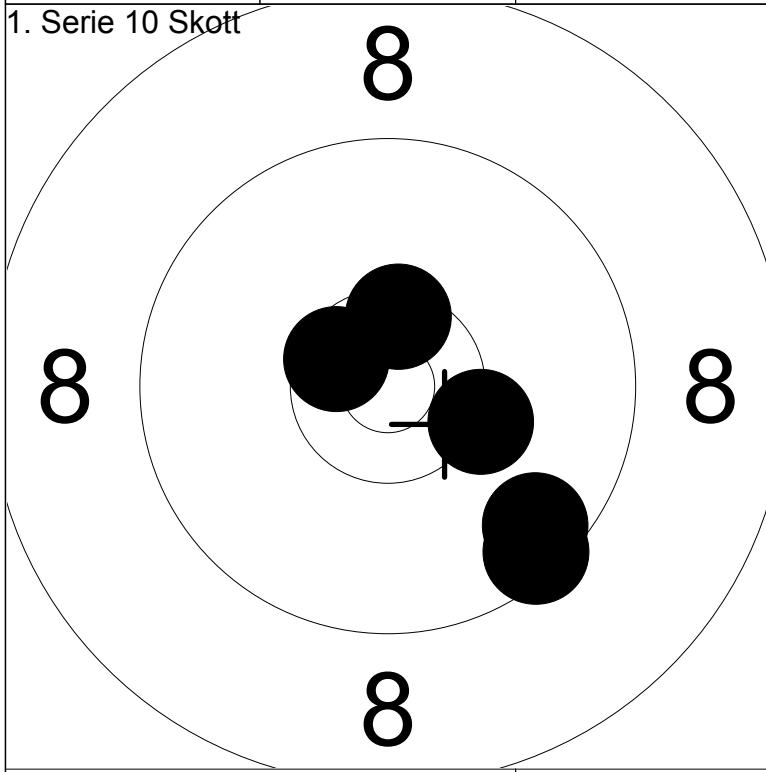

6: 10.3 →	Serie	48.0
7: 9.6 ↘		
8: *10.6 ↗	Total	283.0
9: 9.5 ↘		
10: *10.5 ↑		

1: 10.1 ↘	Serie	46.0
2: 10.1 ↘		
3: 9.8 ↗	Total	329.0
4: 8.3 ↑		
5: 9.4 ↗		

Skjutlag
7

Tavla
18

Lars-Göran Lundqvist

50m

Ununge

7, Vet-L

St

18.07.2015

Tavelträffen KH 2015

Ramselefors SKF

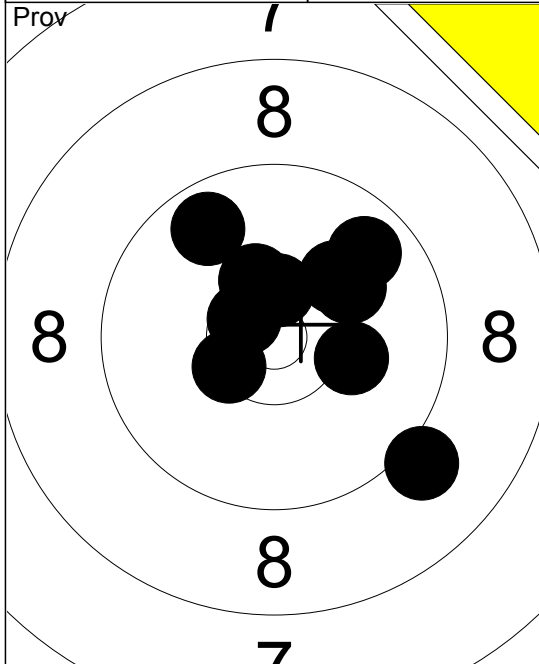

1:	9.7	↖
2:	*10.6	↙
3:	*10.4	↙
4:	*10.4	↖
5:	9.8	↗
6:	*10.5	↑
7:	10.1	↗
8:	10.1	↗
9:	9.1	↘
10:	10.2	→
Serie		97.0
Total		189.0

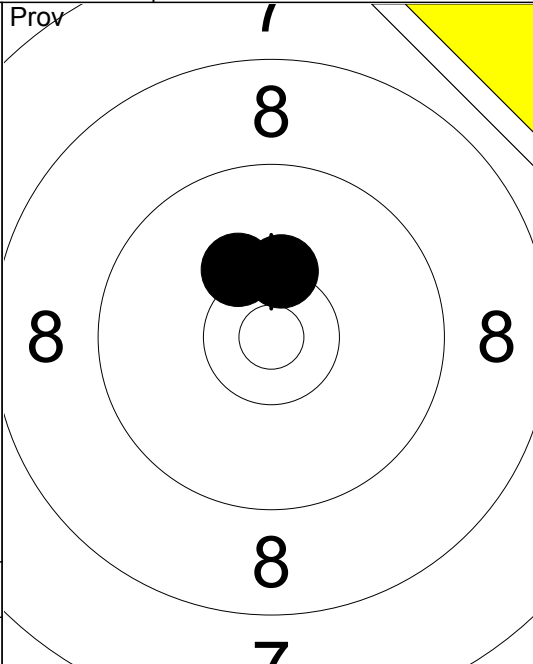

11:	*10.3	↑
12:	10.2	↖
Serie		20.0
Total		189.0

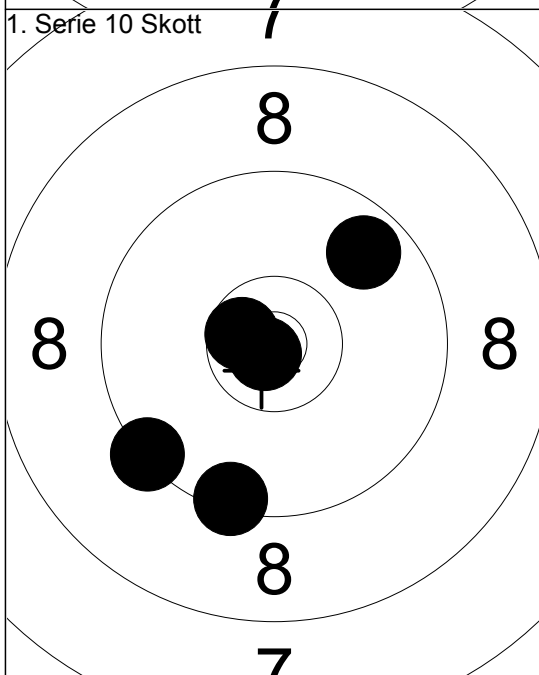

1:	9.3	↙
2:	*10.6	↙
3:	9.4	↘
4:	9.7	↗
5:	*10.8	↙
Serie		47.0
Total		236.0

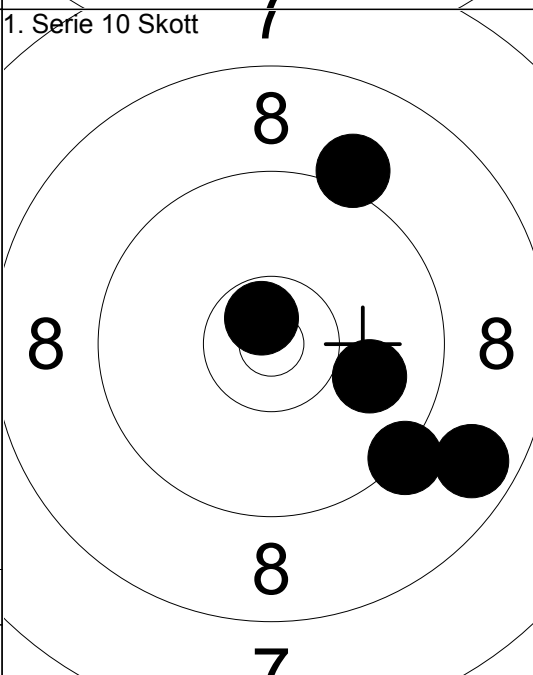

6:	8.7	↘
7:	*10.7	↗
8:	9.1	↗
9:	9.3	↘
10:	10.0	↘
Serie		46.0
Total		282.0

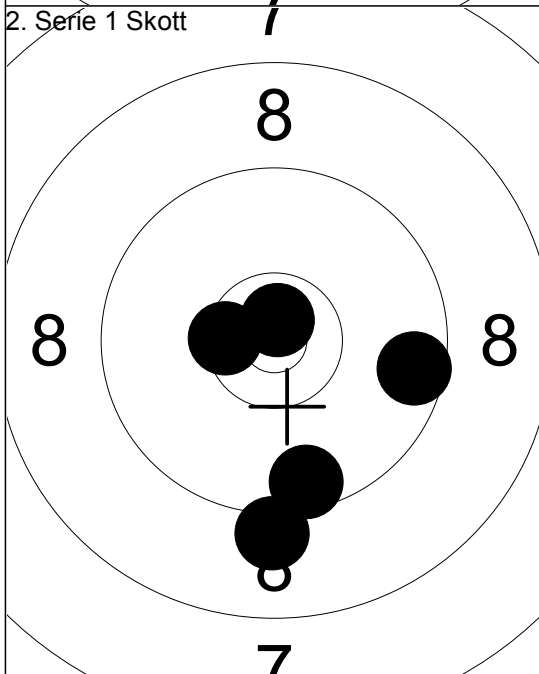

1:	9.6	→
2:	9.1	↓
3:	9.6	↓
4:	*10.5	←
5:	*10.8	↑
Serie		47.0
Total		329.0

Serie		46.0
Total		282.0

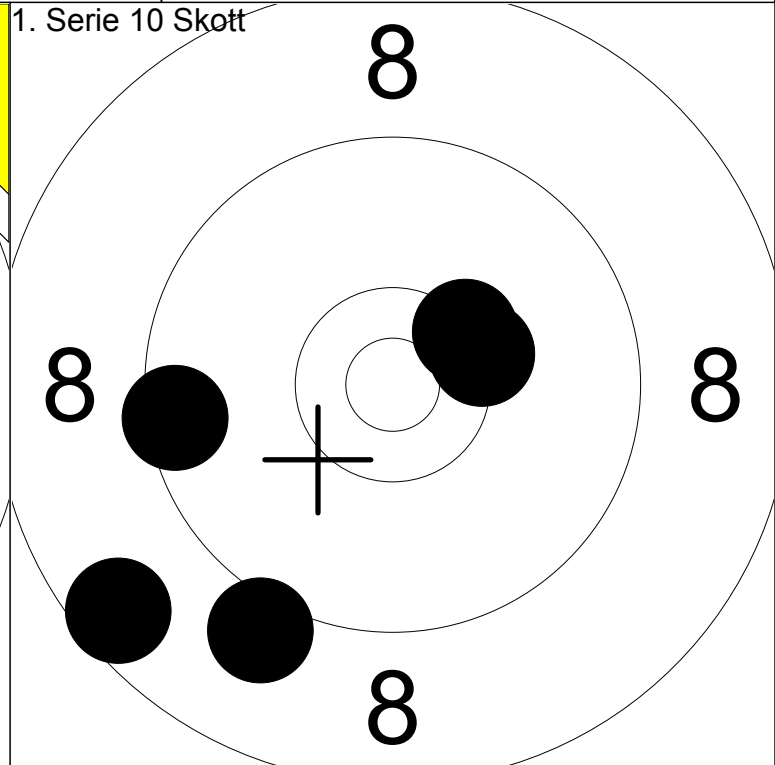
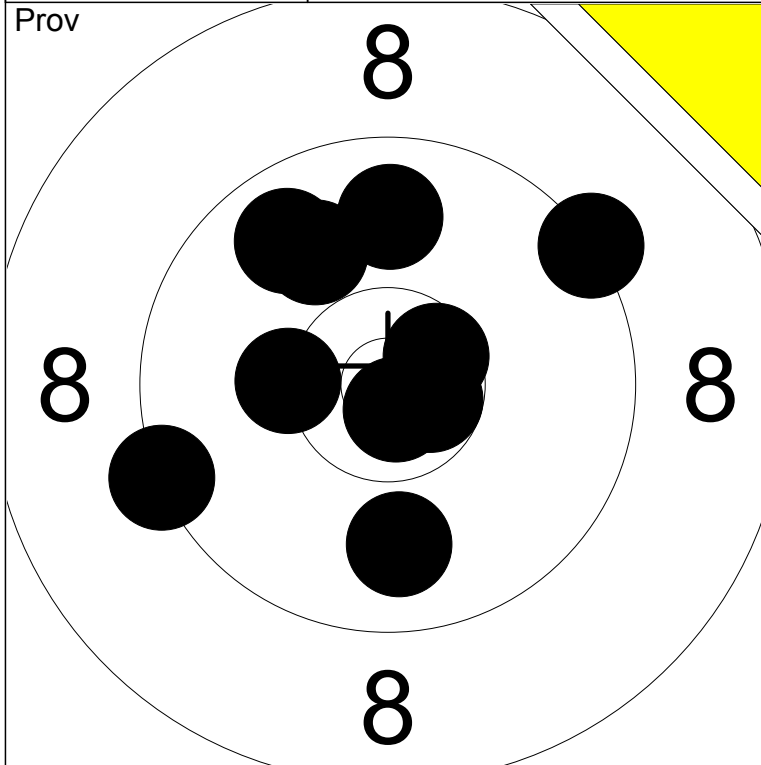

1: 9.3 ↗	6: 10.3 ←	Serie	94.0
2: *10.8 ↓	7: 9.3 ←		
3: 9.8 ↗	8: 9.9 ↓	Total	188.0
4: 9.8 ↑	9: *10.6 ↗		
5: 9.9 ↘	10: *10.7 →		

1: 8.6 ↙	Serie	46.0
2: 9.1 ↓		
3: 9.5 ←	Total	234.0
4: *10.4 ↗		
5: *10.3 →		

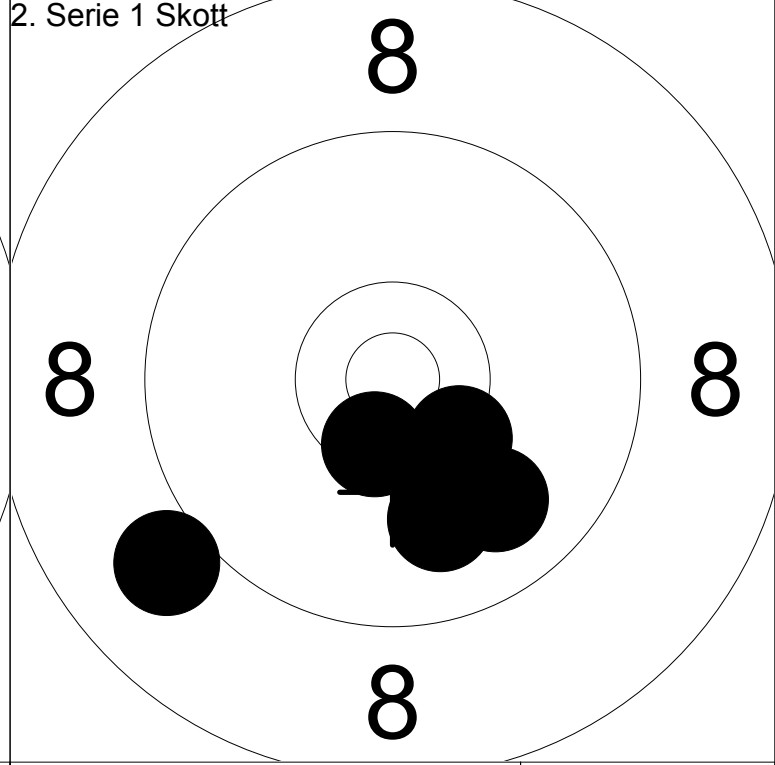
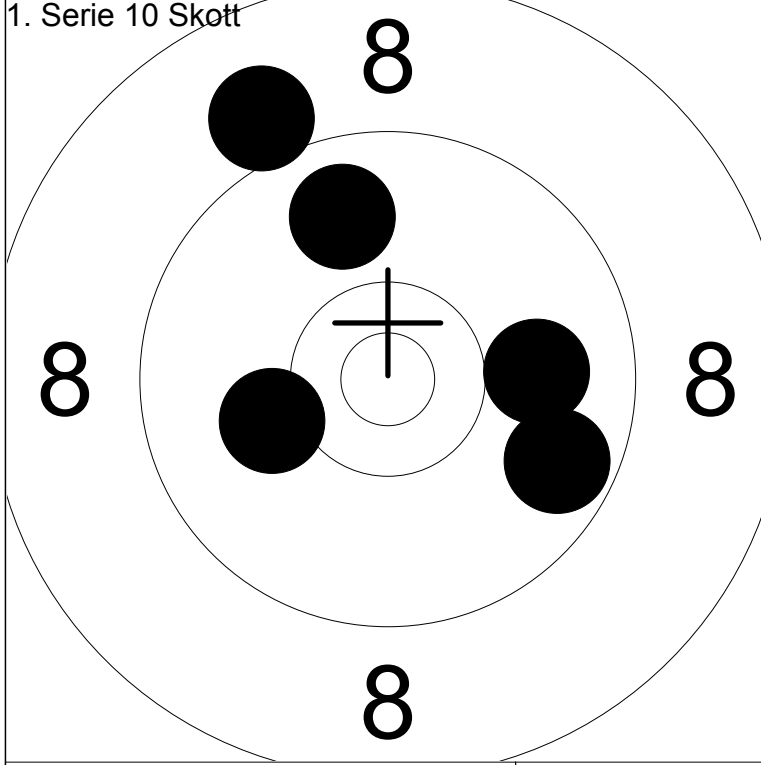

6: 9.7 ↘	Serie	47.0
7: 10.0 →		
8: 9.0 ↗	Total	281.0
9: 9.8 ↑		
10: 10.1 ←		

1: 9.0 ↙	Serie	48.0
2: *10.4 ↓		
3: 9.9 ↓	Total	329.0
4: *10.5 ↓		
5: 10.0 ↓		

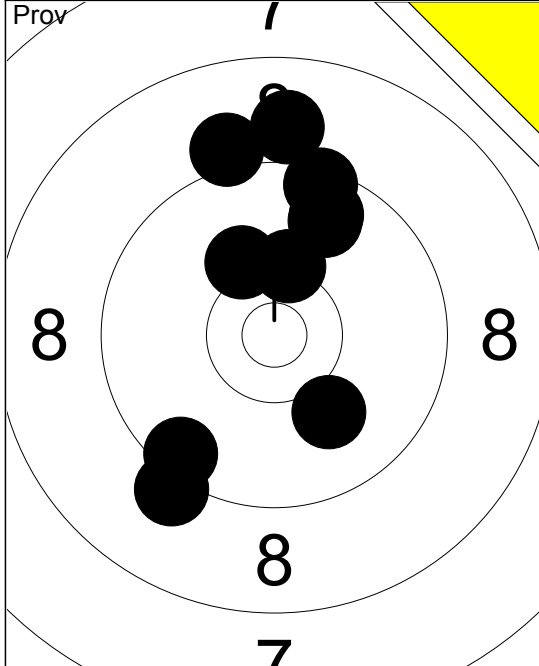

1:	10.3	↗
2:	9.0	↑
3:	9.1	↗
4:	9.7	↗
5:	9.8	↗
6:	10.2	↗
7:	9.5	↘
8:	9.2	↘
9:	10.1	↘
10:	9.4	↗
Serie		93.0
Total		187.0

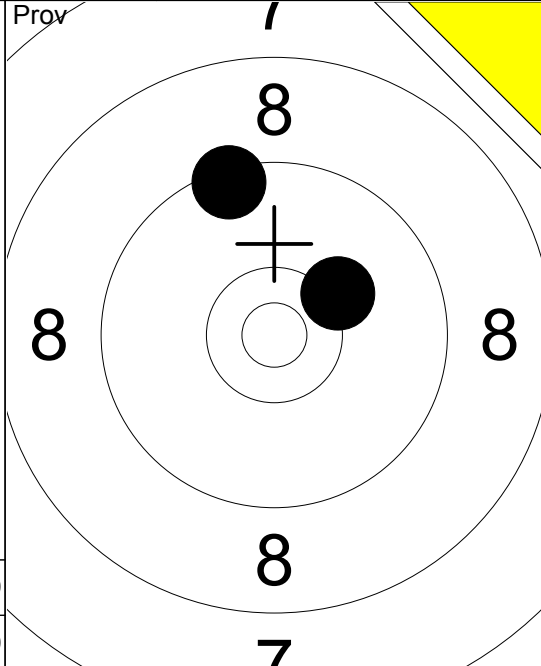

11:	9.4	↗
12:	10.2	↗
Serie		19.0
Total		187.0

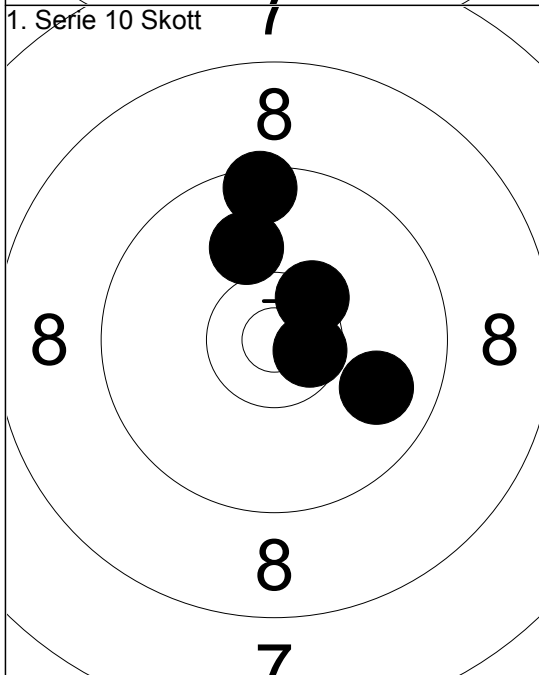

1:	9.5	↑
2:	10.0	↑
3:	*10.6	→
4:	9.9	→
5:	*10.4	↗
Serie		48.0
Total		235.0

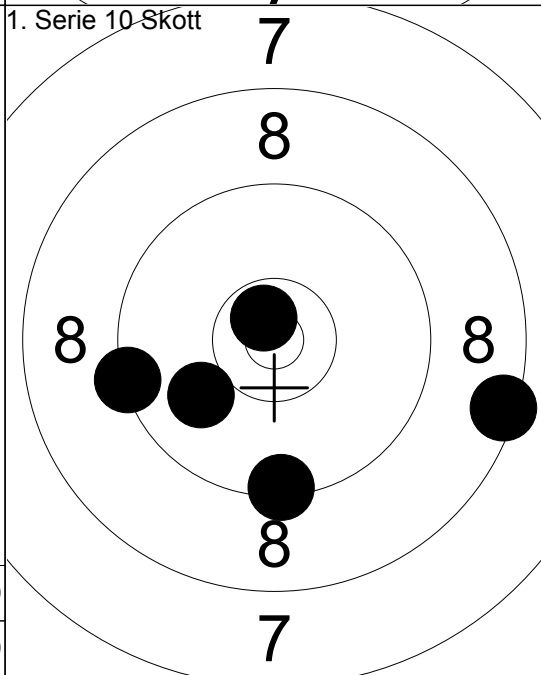

6:	8.4	→
7:	9.3	←
8:	9.4	↓
9:	10.0	↖
10:	*10.7	↗
Serie		46.0
Total		281.0

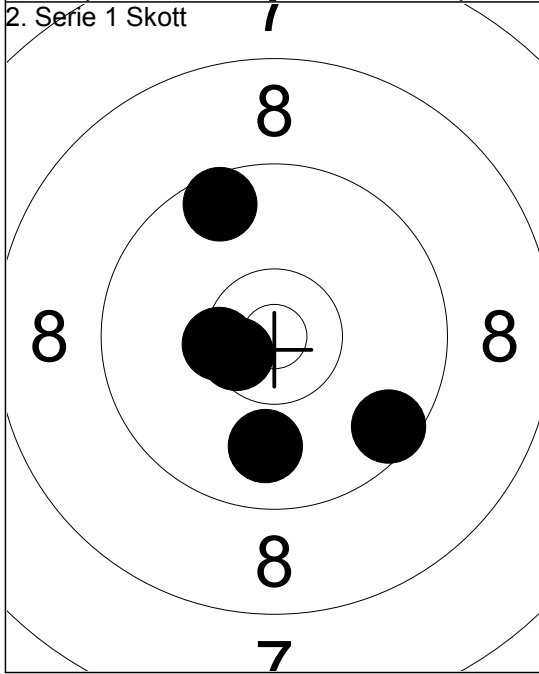

1:	*10.4	←
2:	*10.6	↖
3:	9.9	↓
4:	9.6	↘
5:	9.6	↗
Serie		47.0
Total		328.0

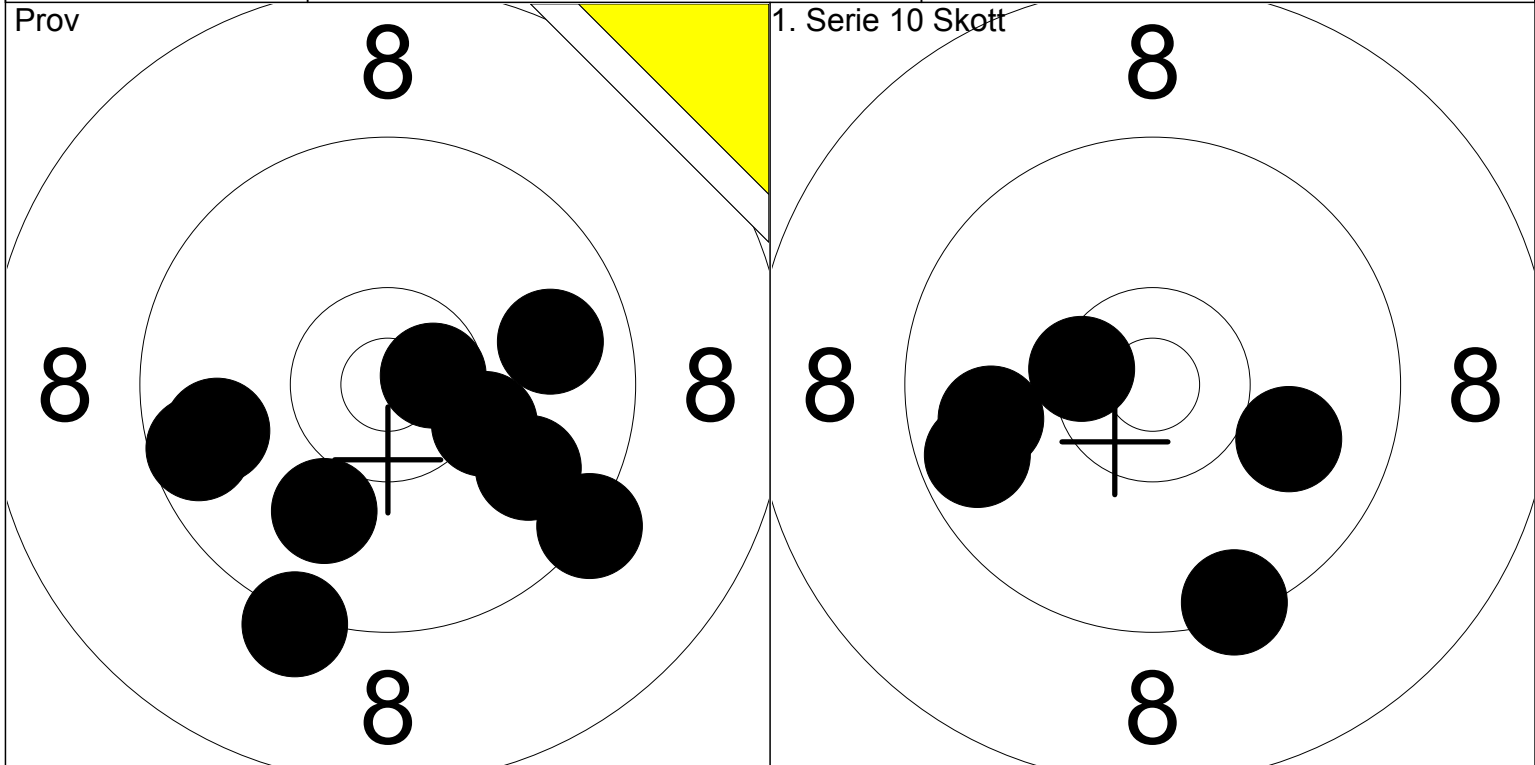

1: 9.3 ↘	6: 9.6 ←	Serie 84.0	1: 9.7 ←	Serie 47.0
2: *10.6 →	7: 10.3 ↘		2: 9.9 ←	
3: 9.9 ↘	8: 9.8 →	Total 186.0	3: 10.0 ↘	Total 233.0
4: 9.2 ↓	9: 10.0 ↓		4: *10.5 ←	
5: 9.8 ←			5: 9.4 ↓	

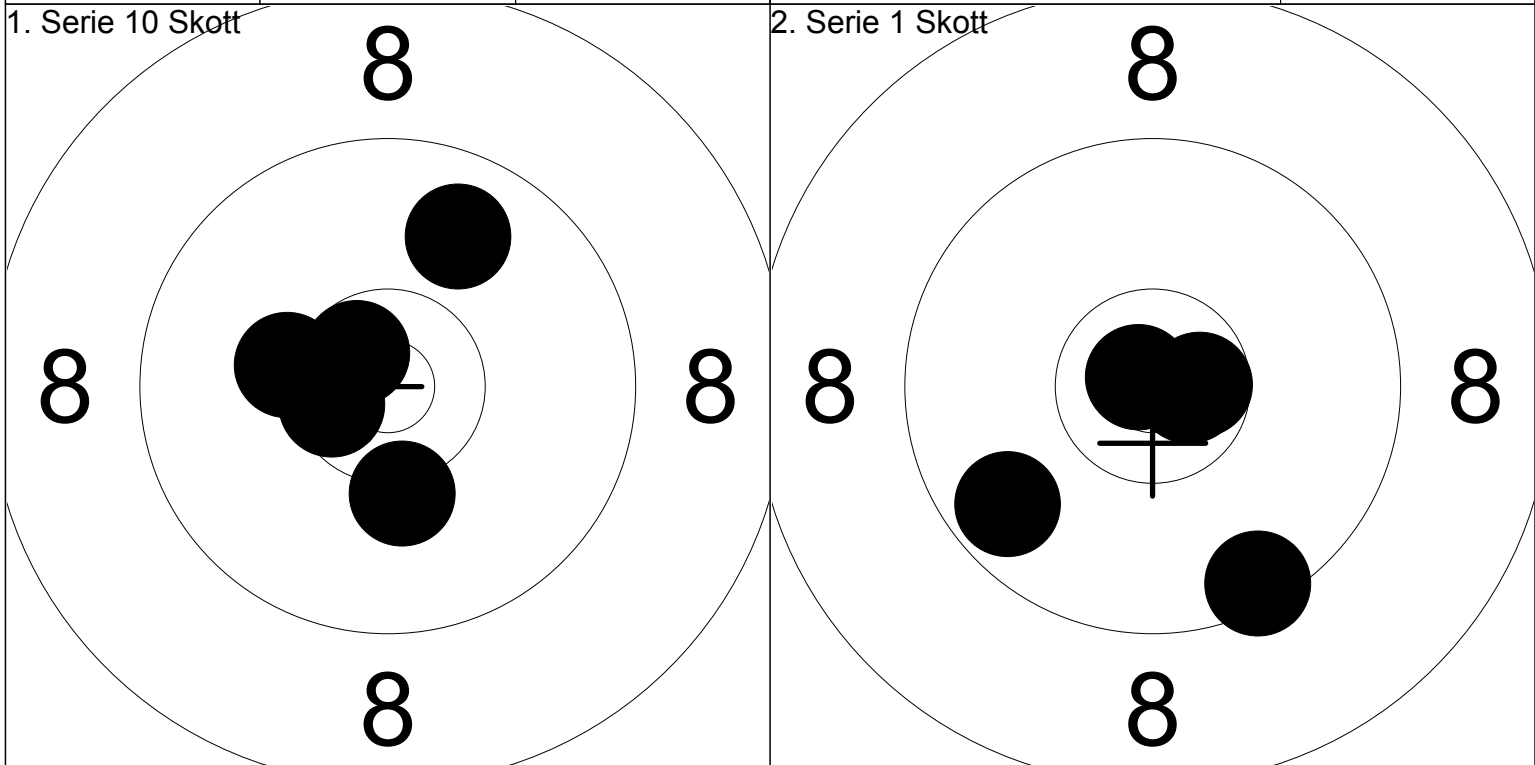

6: 10.3 ←	Serie 49.0	1: *10.7 →	Serie 48.0
7: *10.6 ←		2: 9.5 ↓	
8: 10.2 ↓	Total 282.0	3: *10.8 ↖	Total 330.0
9: 9.8 ↗		4: *10.6 →	
10: *10.6 ↖		5: 9.7 ↓	

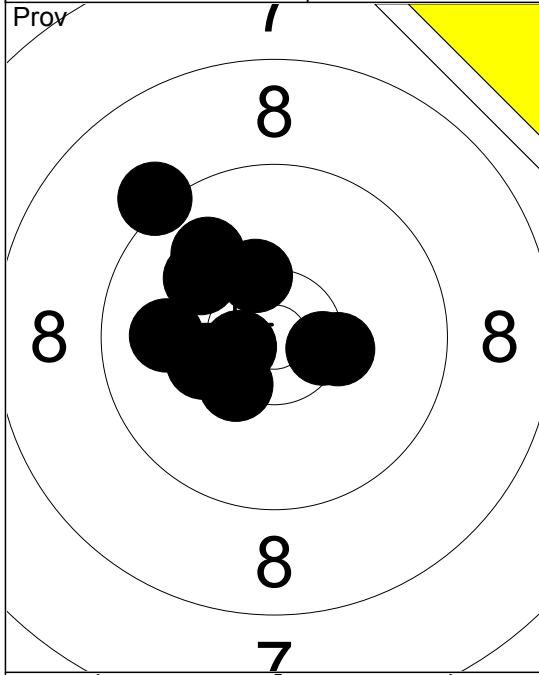

Prov

1:	9.2	↖
2:	*10.3	↖
3:	10.0	↖
4:	10.2	↖
5:	*10.5	→
6:	*10.4	↙
7:	9.9	↖
8:	*10.3	→
9:	*10.6	↖
10:	9.9	↖
Serie	97.0	
Total	185.0	

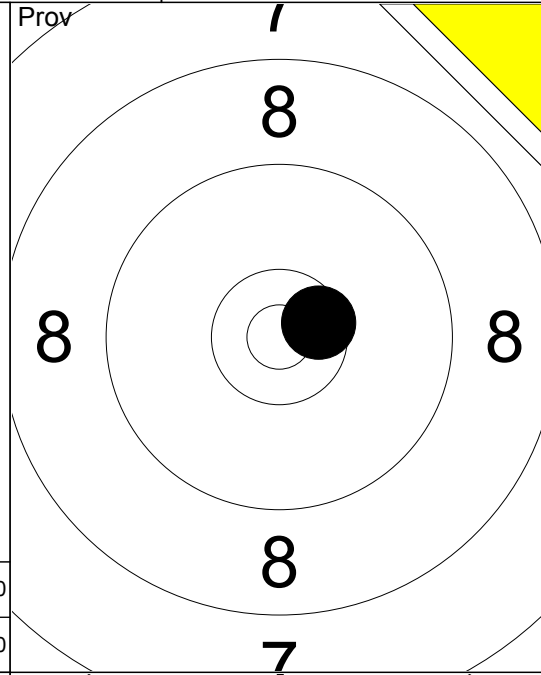

Prov

11:	*10.6	→
Serie	10.0	
Total	185.0	

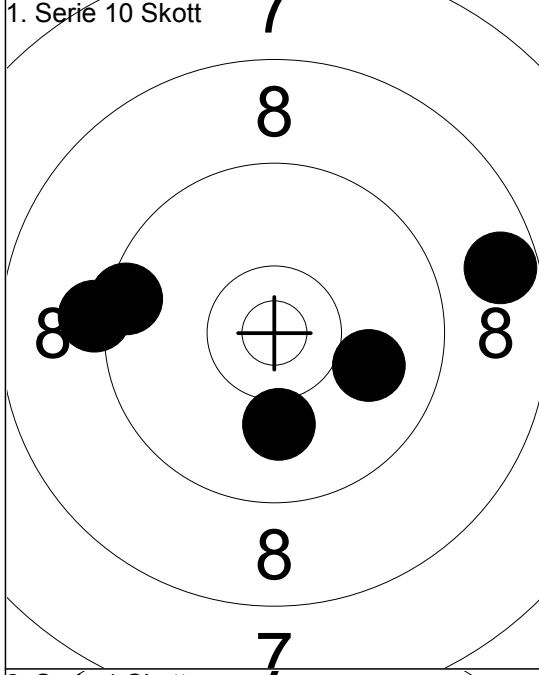

1:	9.5	↖
2:	9.2	↖
3:	10.1	↓
4:	8.7	→
5:	10.0	→
Serie	46.0	
Total	231.0	

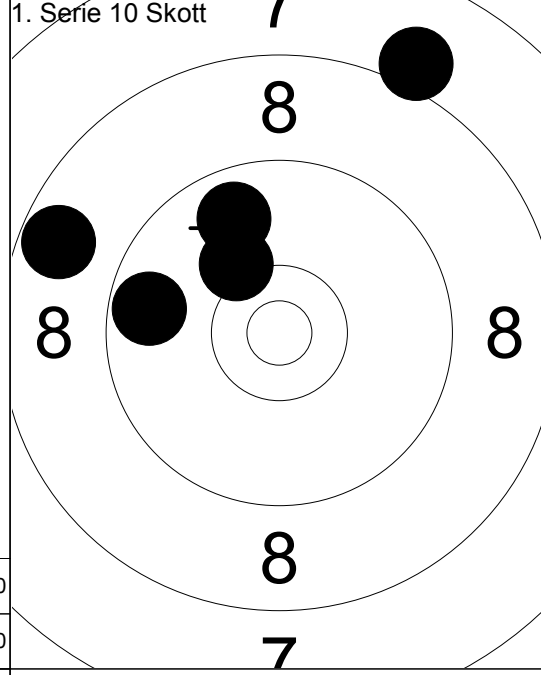

6:	8.7	↖
7:	10.2	↖
8:	9.8	↖
9:	9.7	↖
10:	8.1	↖
Serie	44.0	
Total	275.0	

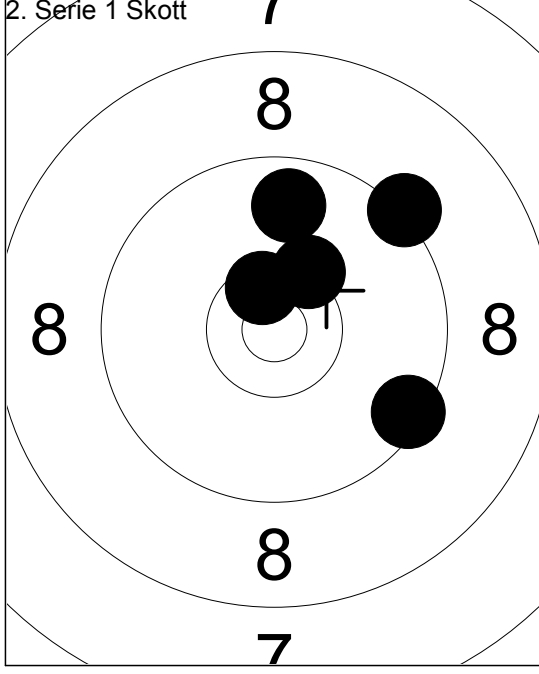

1:	9.8	↖
2:	9.3	↖
3:	*10.5	↖
4:	9.5	↖
5:	*10.3	↖
Serie	47.0	
Total	322.0	

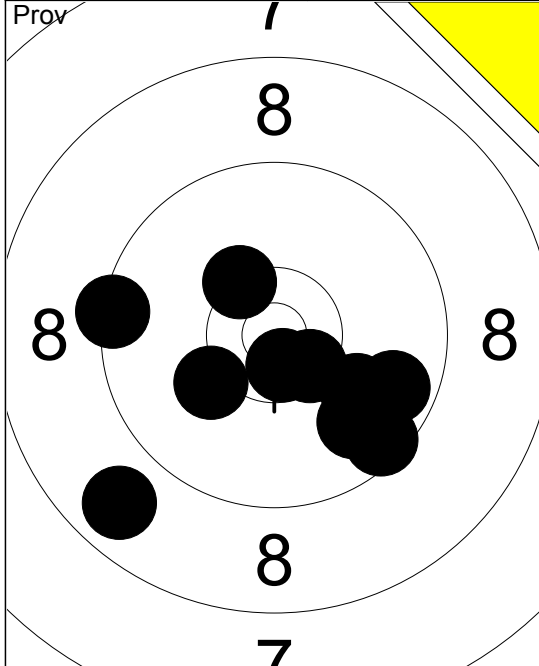

1:	8.8	↙
2:	10.0	↘
3:	9.8	↘
4:	9.5	↘
5:	9.4	←
6:	*10.7	↘
7:	*10.5	↘
8:	9.7	↘
9:	10.2	↙
10:	*10.3	↖
Serie		94.0
Total		180.0

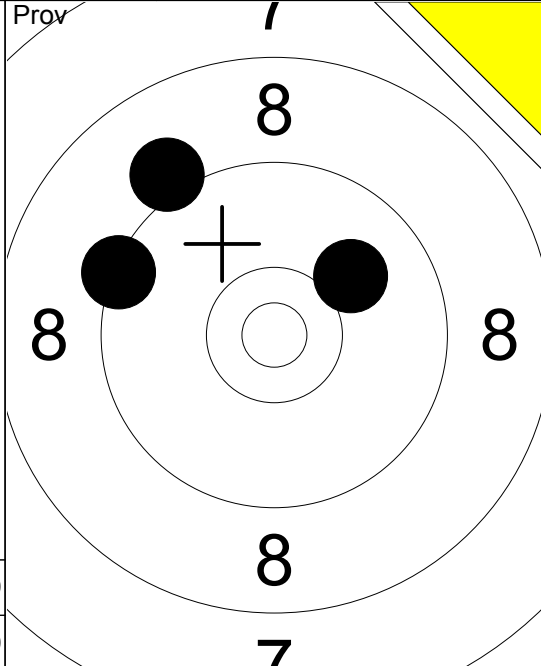

11:	9.4	↖
12:	10.0	↗
13:	9.1	↖
Serie		28.0
Total		180.0

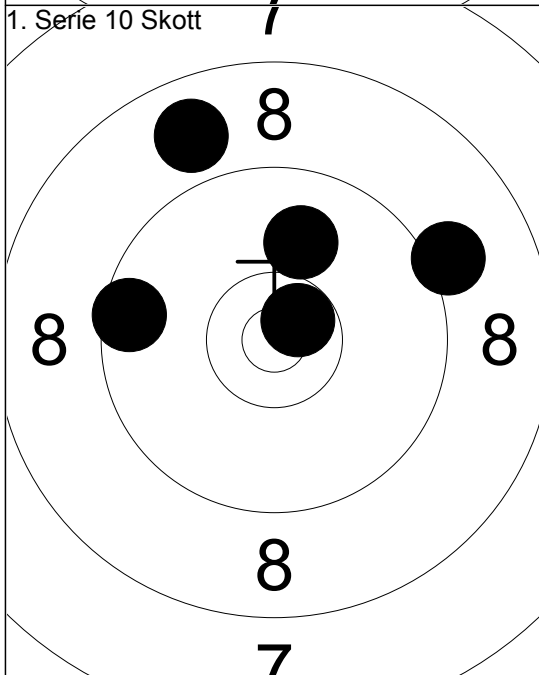

1:	8.9	↖
2:	9.5	←
3:	10.0	↖
4:	*10.7	↗
5:	9.1	↗
Serie		46.0
Total		226.0

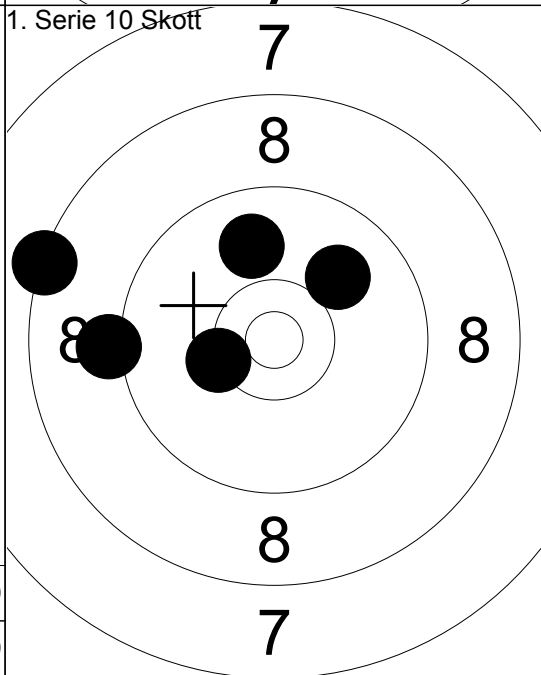

6:	9.9	↖
7:	8.3	←
8:	10.0	↗
9:	9.2	←
10:	*10.3	←
Serie		46.0
Total		272.0

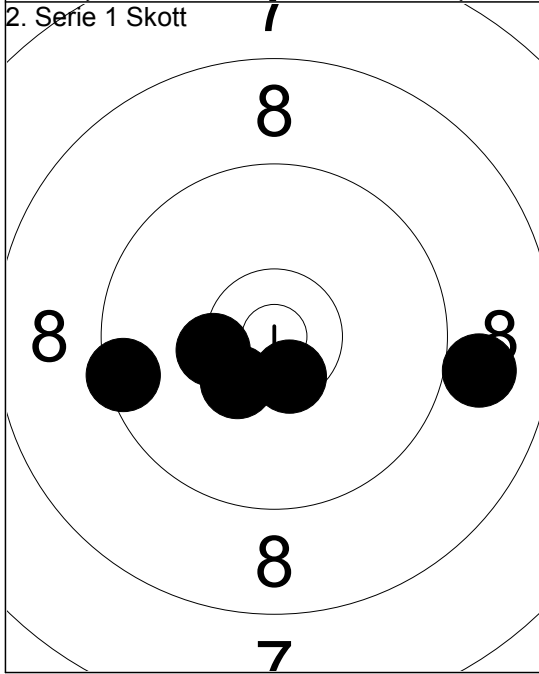

1:	*10.4	↘
2:	9.5	←
3:	*10.5	↘
4:	9.0	→
5:	*10.3	←
Serie		48.0
Total		320.0

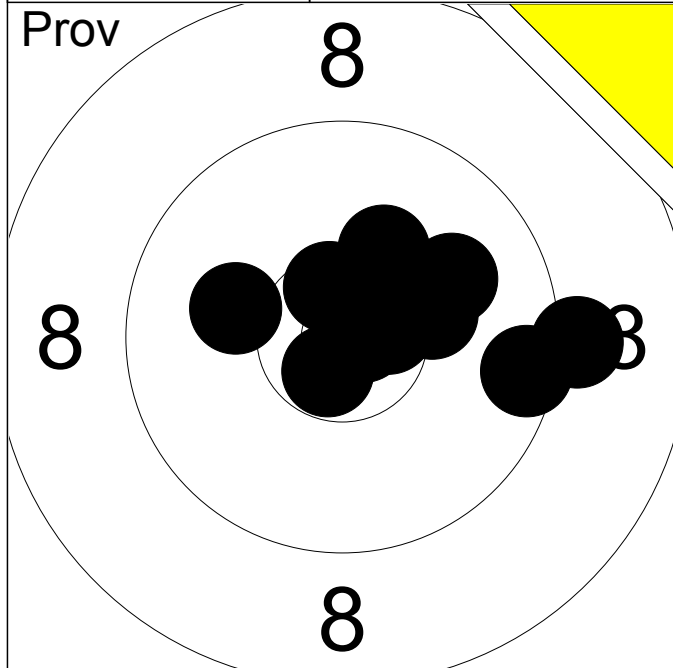

1:	9.5	→
2:	9.2	→
3:	*10.6	↑
4:	*10.6	→
5:	10.2	↑
6:	10.2	→
7:	10.0	↗
8:	10.1	←
9:	*10.8	→
10:	*10.7	↓

Serie	98.0
-------	------

Total	191.0
-------	-------

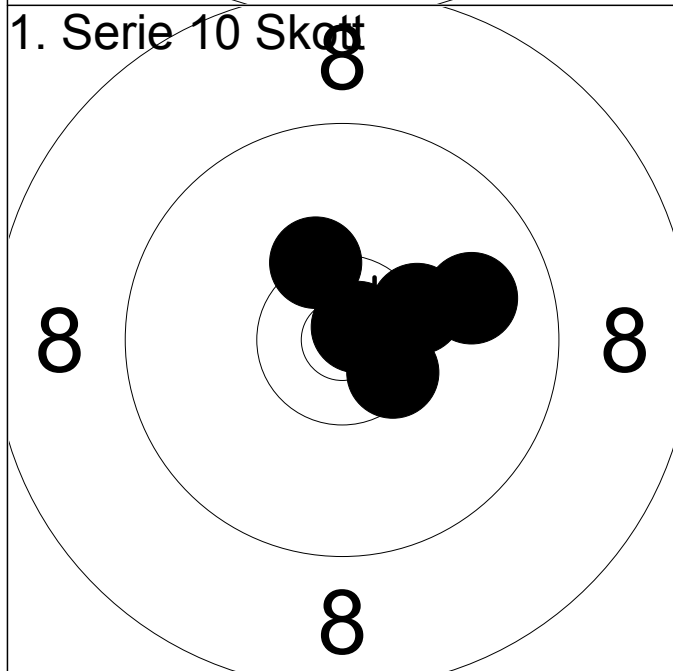

1:	9.9	→
2:	*10.8	↗
3:	*10.5	↘
4:	*10.3	↗
5:	*10.3	↑

Serie	49.0
-------	------

Total	240.0
-------	-------

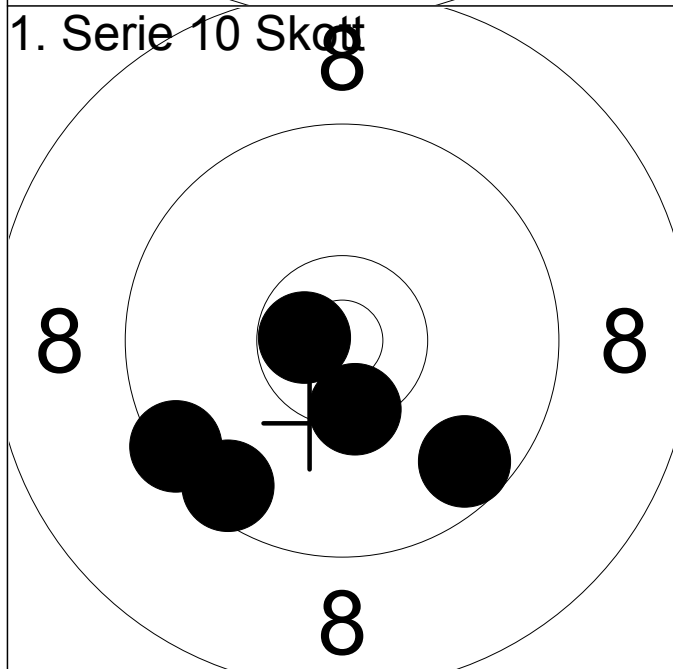

6:	*10.4	↓
7:	9.6	↘
8:	9.4	←
9:	9.5	↘
10:	*10.7	←

Serie	47.0
-------	------

Total	287.0
-------	-------

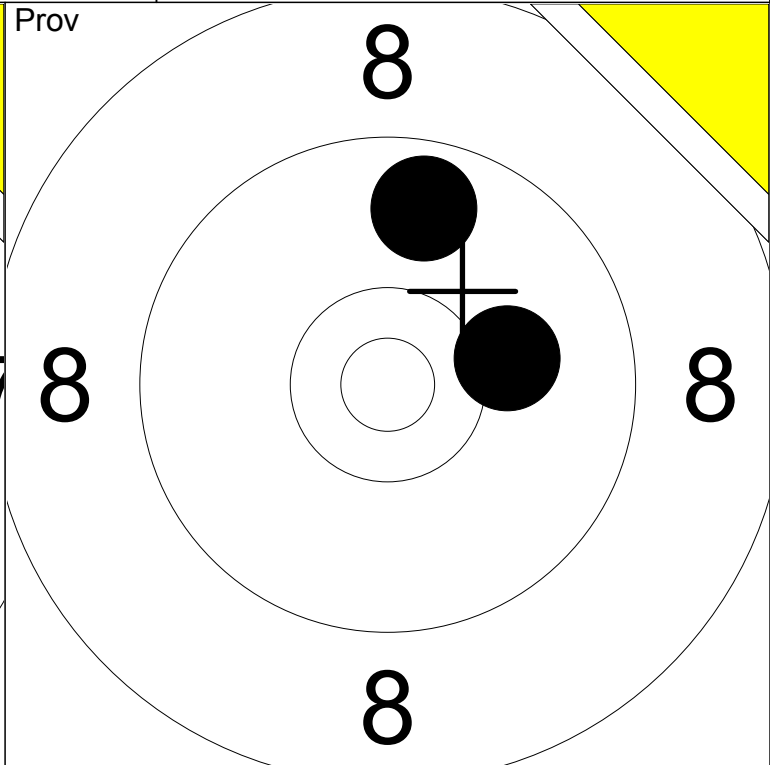
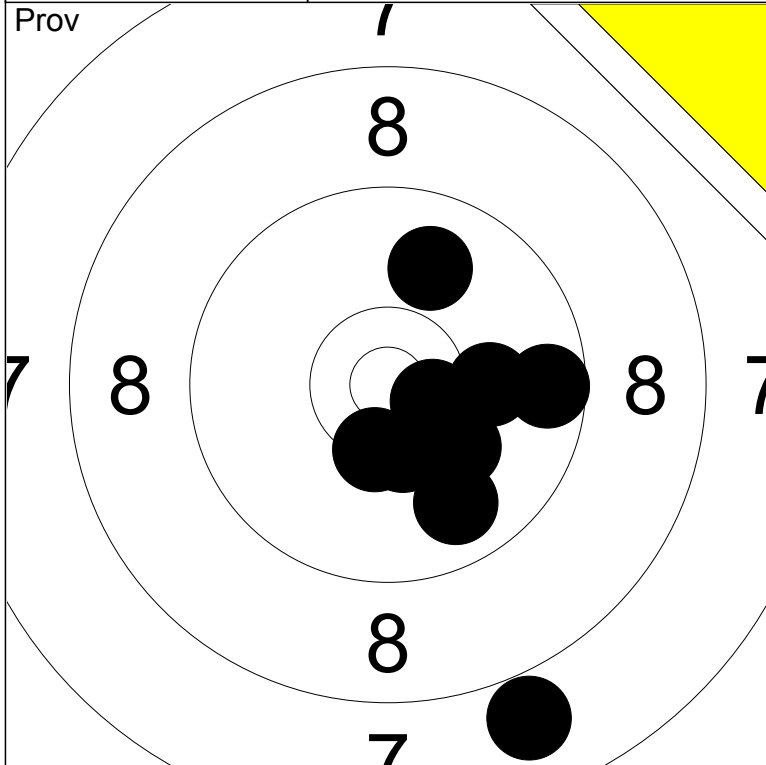

1: 10.2 ↘	6: 9.6 →	Serie 94.0
2: 10.1 →	7: 9.8 ↘	
3: 7.9 ↘	8: *10.6 ↘	Total 189.0
4: 9.9 ↗	9: *10.4 ↘	
5: *10.4 ↘	10: *10.4 ↘	

11: 9.8 ↗	Serie 19.0
12: 10.1 →	
Total 189.0	

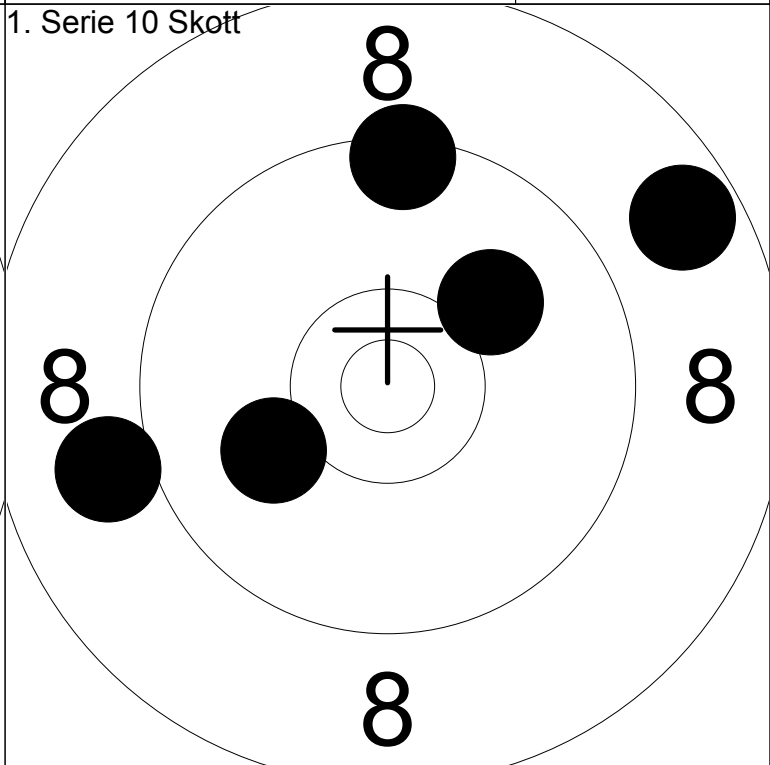
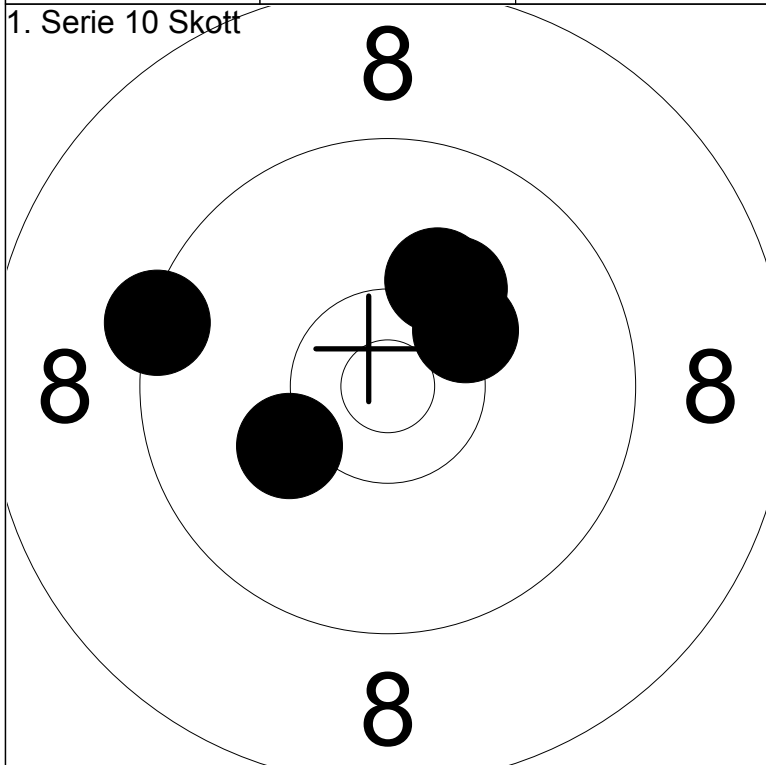

1: 9.4 ←	Serie 49.0
2: 10.2 ↗	
3: 10.2 ←	Total 238.0
4: 10.2 ↗	
5: *10.3 ↗	

6: 10.1 ↗	Serie 46.0
7: 9.0 ←	
8: 9.4 ↗	Total 284.0
9: 8.7 ↗	
10: 10.1 ←	

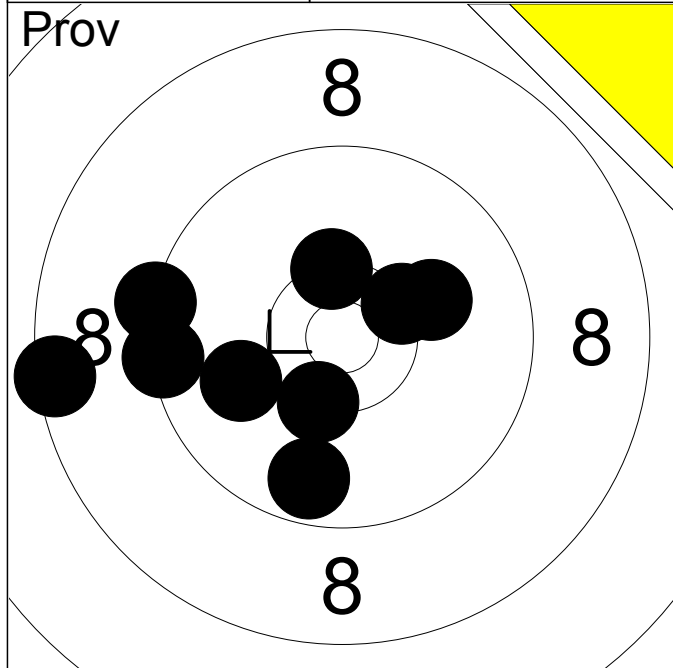

1:	8.4	←
2:	9.3	←
3:	9.7	↓
4:	10.0	←
5:	9.4	←
6:	*10.4	↓
7:	10.1	↗
8:	*10.4	↗
9:	*10.4	↑

Serie	85.0
-------	------

Total	189.0
-------	-------

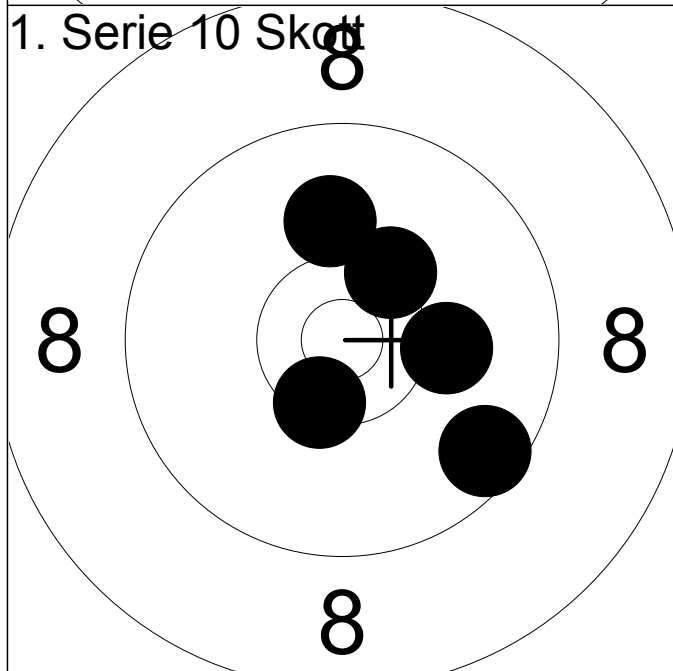

1:	*10.3	↗
2:	9.6	↘
3:	10.0	↑
4:	*10.4	↓
5:	10.2	→

Serie	49.0
-------	------

Total	238.0
-------	-------

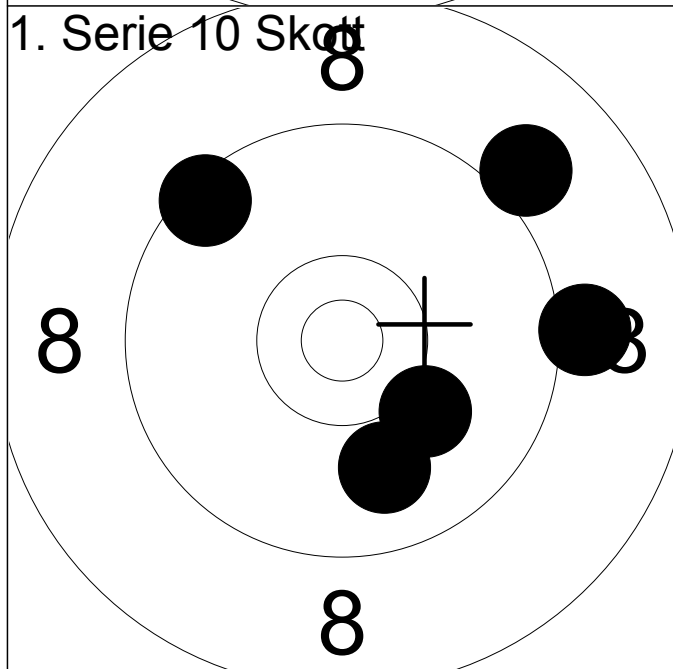

6:	9.1	→
7:	9.0	↗
8:	10.1	↘
9:	9.9	↘
10:	9.5	↗

Serie	46.0
-------	------

Total	284.0
-------	-------

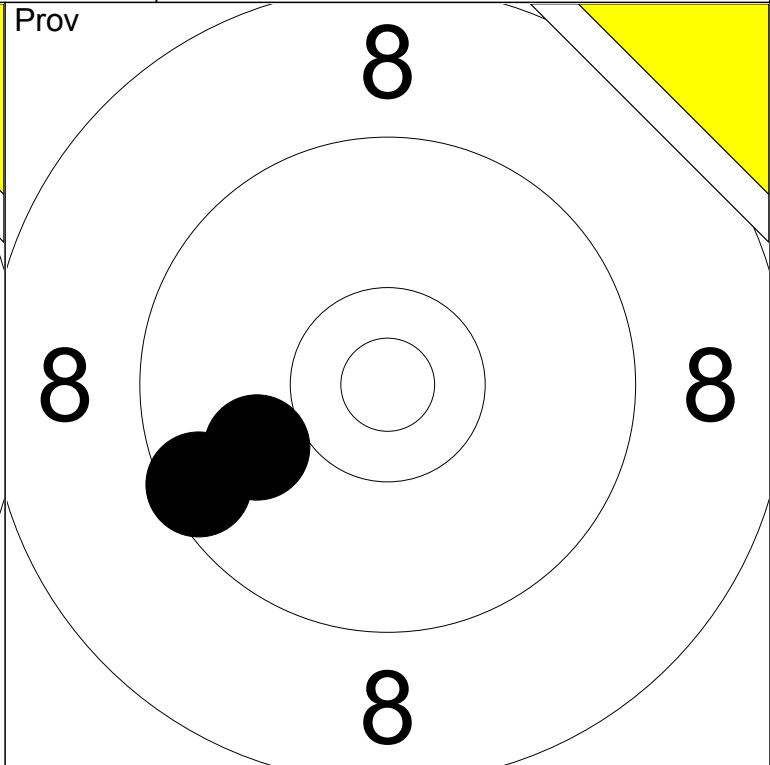
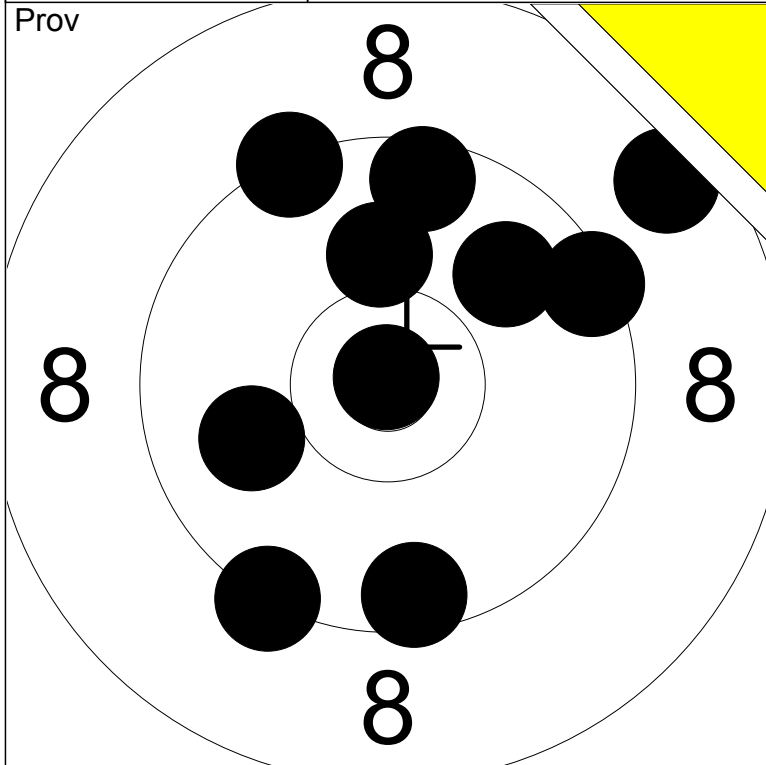

1: 9.5 ↓	6: 10.1 ↑	Serie 92.0
2: 8.7 ↗	7: 9.9 ↗	
3: 9.6 ↑	8: 10.0 ←	Total 188.0
4: 9.4 ↗	9: 9.3 ↑	
5: *10.9 ↑	10: 9.3 ↓	

11: 9.5 ↙	Serie 19.0
12: 10.0 ↙	
Total 188.0	

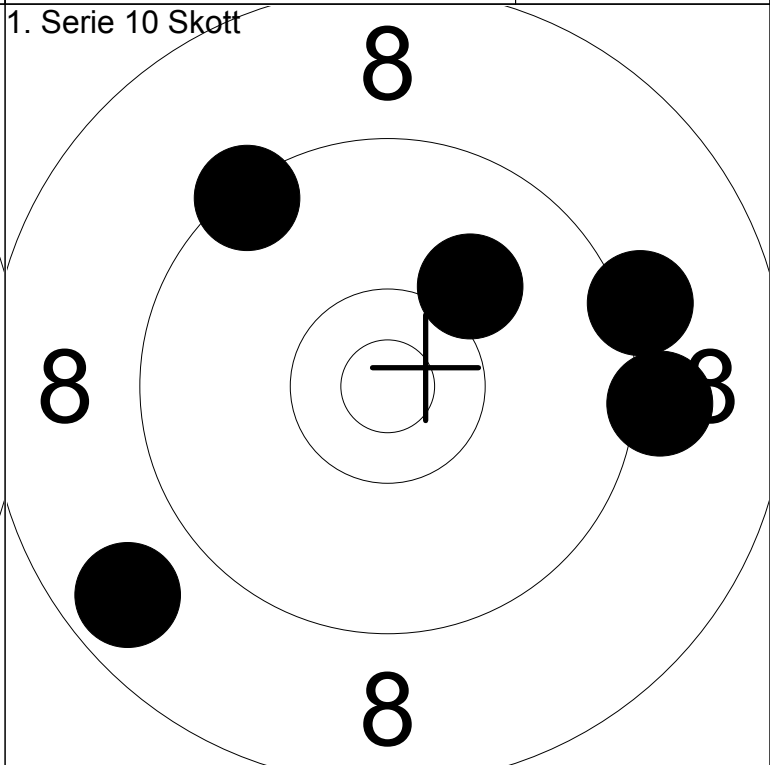
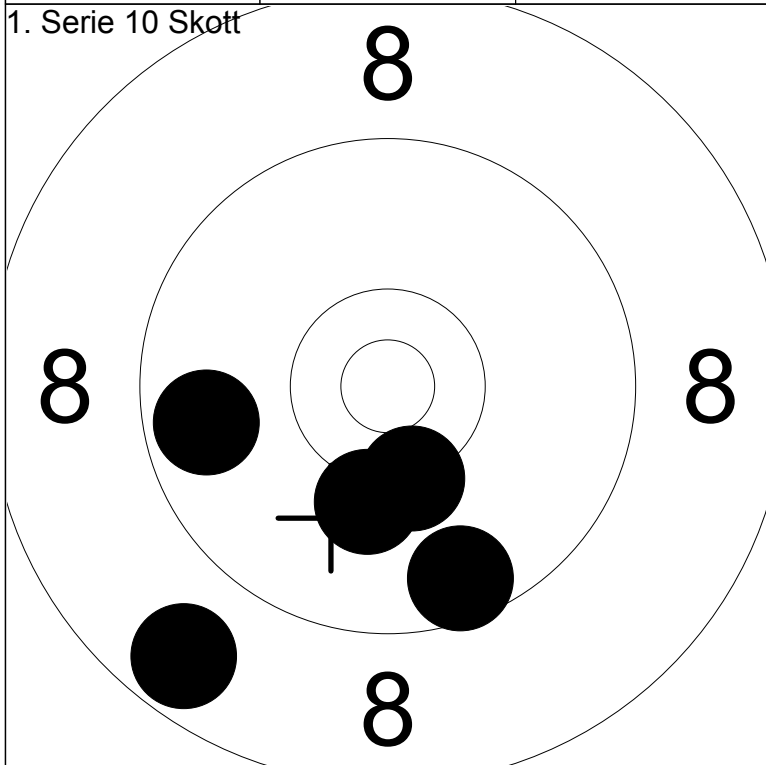

1: 10.2 ↓	Serie 46.0
2: *10.3 ↓	
3: 9.7 ←	Total 234.0
4: 8.7 ↙	
5: 9.6 ↓	

6: 10.1 ↗	Serie 45.0
7: 8.7 ↙	
8: 9.2 →	Total 279.0
9: 9.1 →	
10: 9.4 ↗	

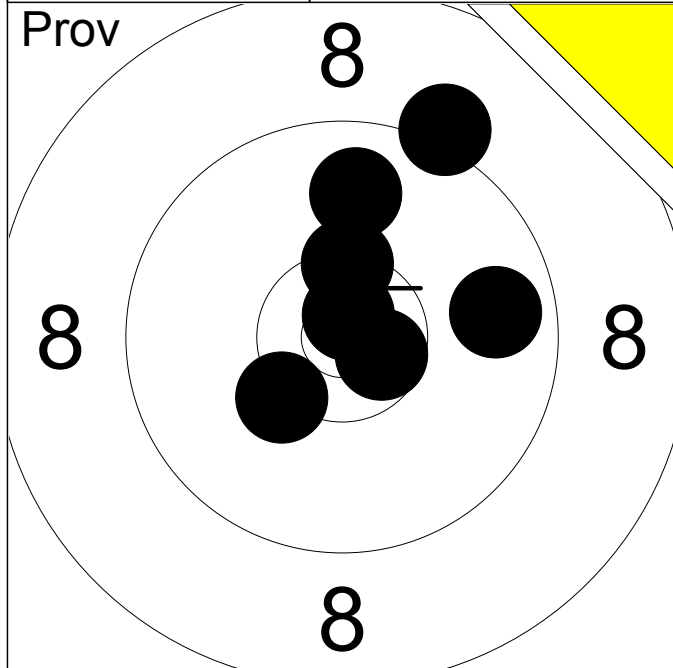

1:	9.8	→
2:	*10.6	↘
3:	*10.4	↑
4:	*10.8	↗
5:	9.9	↑
6:	9.2	↗
7:	*10.3	↙

Serie	67.0
-------	------

Total	186.0
-------	-------

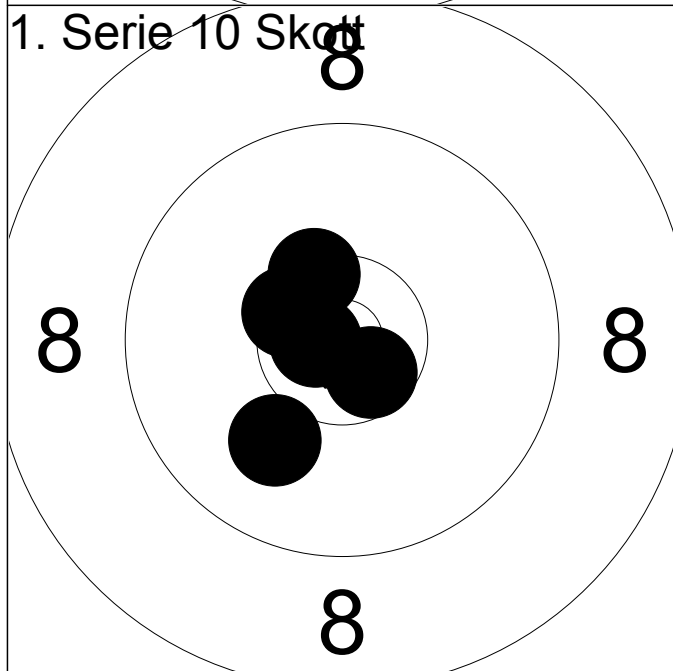

1:	*10.4	↗
2:	*10.6	↘
3:	*10.5	↗
4:	10.0	↘
5:	*10.7	←

Serie	50.0
-------	------

Total	236.0
-------	-------

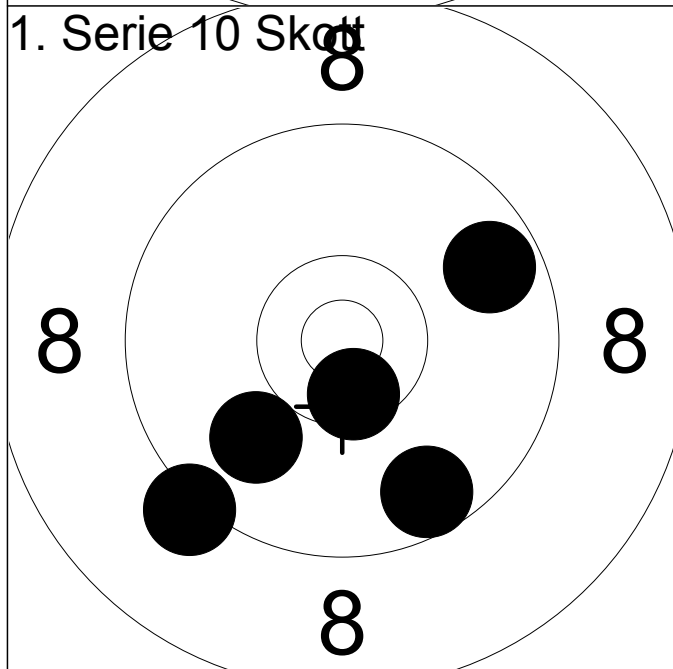

6:	9.6	↘
7:	9.7	↗
8:	9.2	↘
9:	*10.5	↘
10:	10.0	↘

Serie	47.0
-------	------

Total	283.0
-------	-------

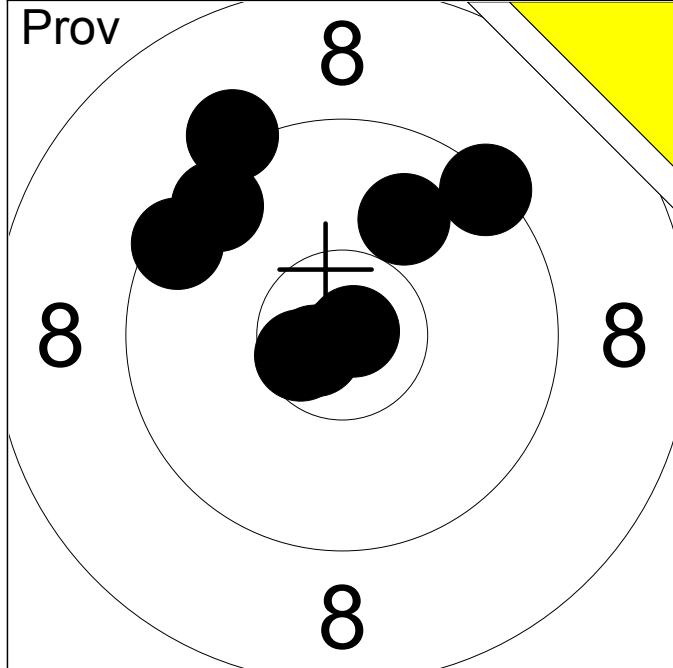

1:	9.2	↗
2:	9.4	↗
3:	*10.6	↖
4:	*10.7	↖
5:	*10.9	↗
6:	9.6	↗
7:	9.9	↗
8:	9.5	↖
Serie		75.0
Total		186.0

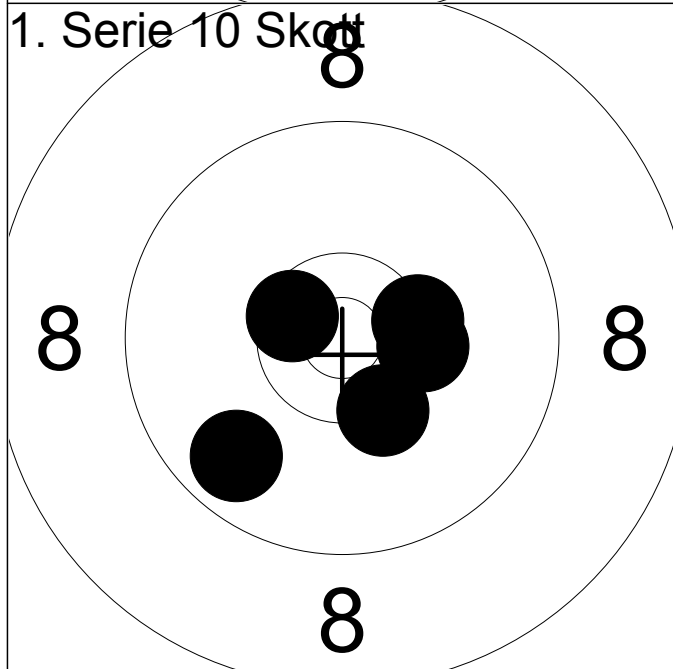

1:	*10.4	→
2:	*10.3	→
3:	*10.5	↖
4:	9.7	↖
5:	*10.3	↘
Serie		49.0
Total		235.0

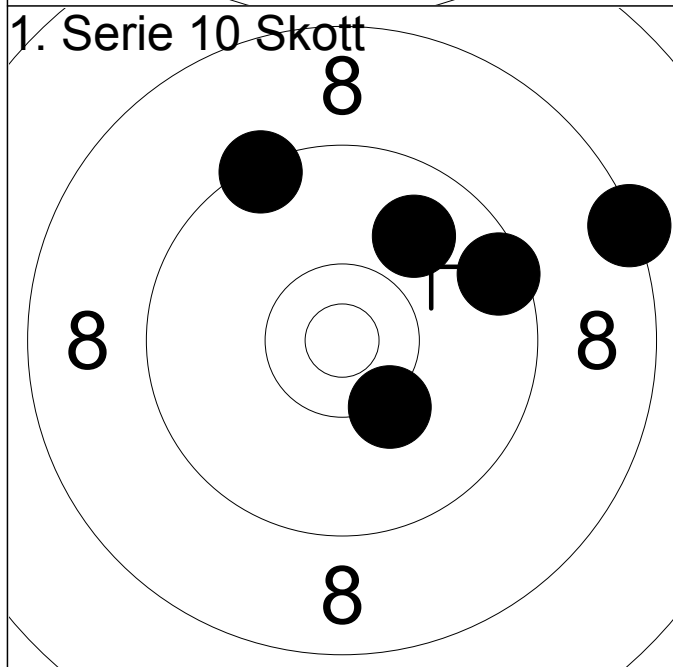

6:	9.5	↗
7:	9.9	↗
8:	9.4	↗
9:	8.3	↗
10:	10.3	↘
Serie		45.0
Total		280.0

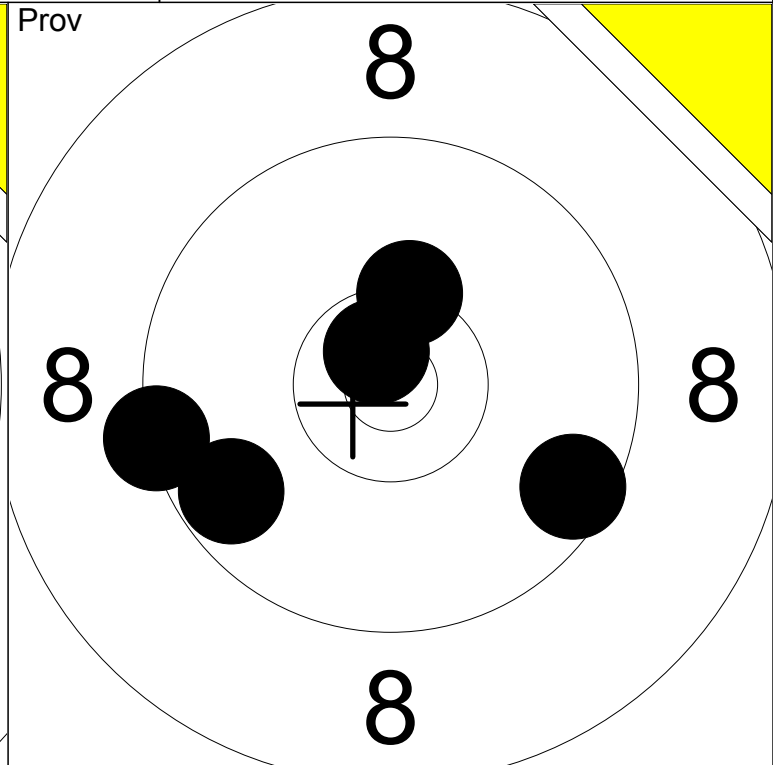
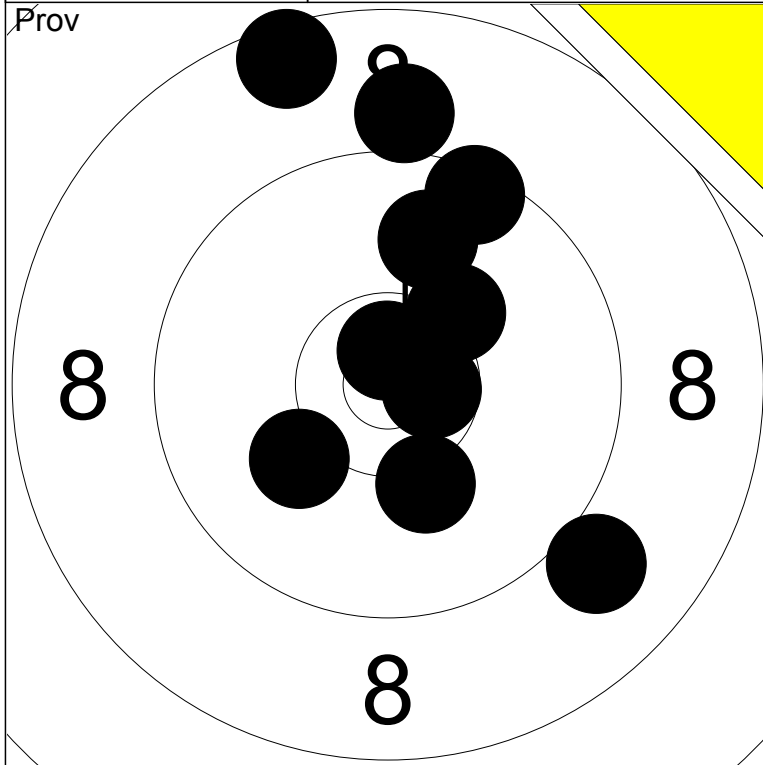

1: 8.5	↑	6: 10.3	↗	Serie	94.0
2: 9.9	↑	7: 10.1	↙		
3: 9.5	↗	8: 9.0	↘		
4: 9.0	↑	9: *10.7	↑		
5: *10.6	→	10: 10.2	↘		

11: 9.6	→	Serie	47.0
12: 9.7	↙		
13: *10.7	↑		
14: 9.4	←		
15: *10.3	↑		

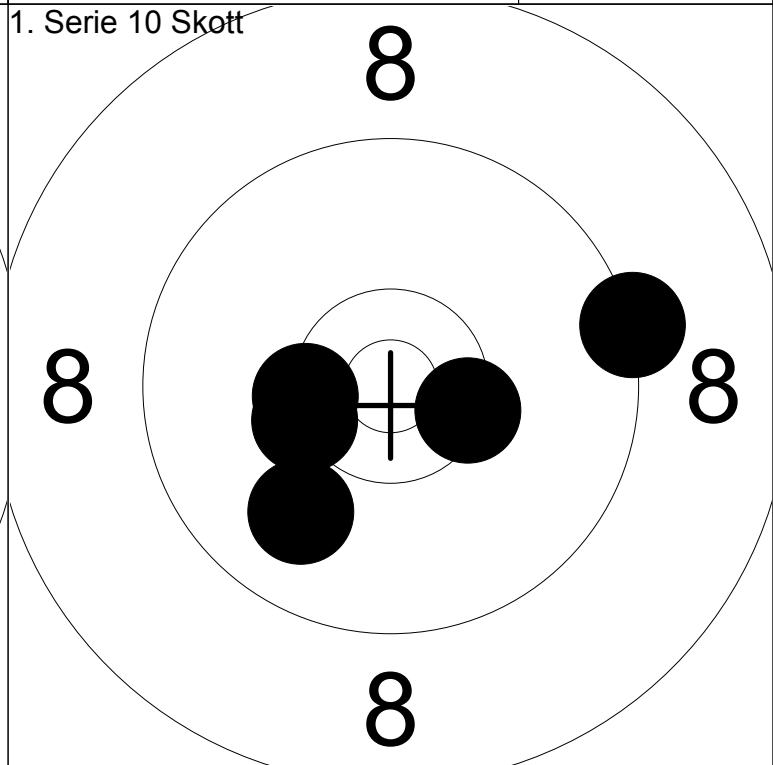
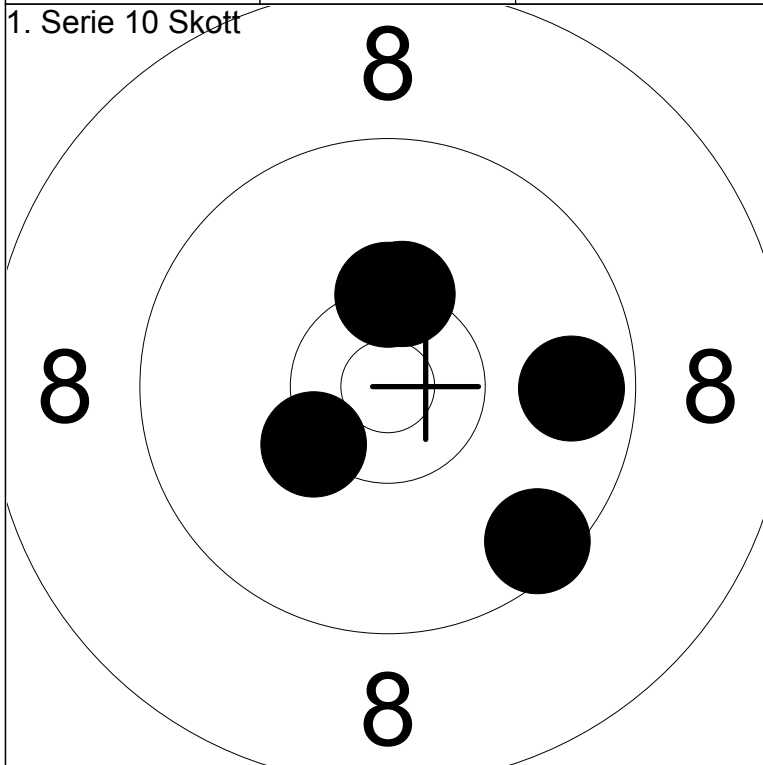

1: *10.3	↑	Serie	48.0
2: *10.3	↙		
3: 9.5	↘		
4: *10.3	↑		
5: 9.7	→		

6: *10.4	→	Serie	48.0
7: *10.3	↙		
8: 9.3	→		
9: 9.9	↘		
10: *10.4	←		

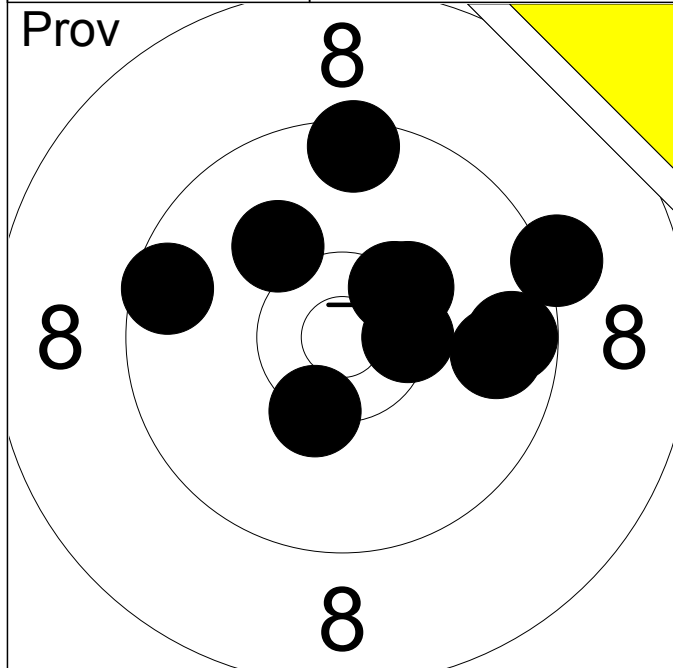

1:	9.5	↑
2:	9.8	→
3:	9.7	→
4:	9.2	→
5:	*10.3	↘
6:	10.1	↗
7:	*10.3	↗
8:	*10.4	↗
9:	9.6	←
10:	*10.5	→
Serie		95.0
Total		184.0

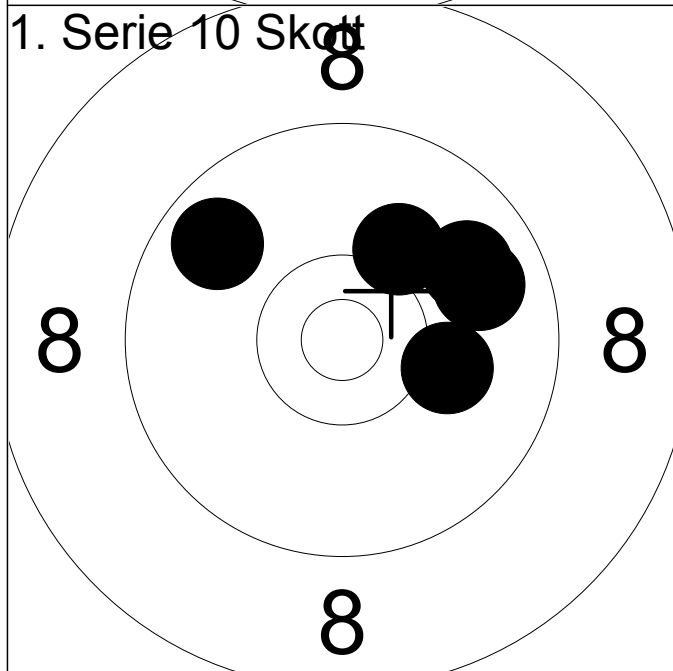

1:	9.8	↗
2:	10.1	→
3:	9.8	↗
4:	9.8	↖
5:	10.1	↗
Serie		47.0
Total		231.0

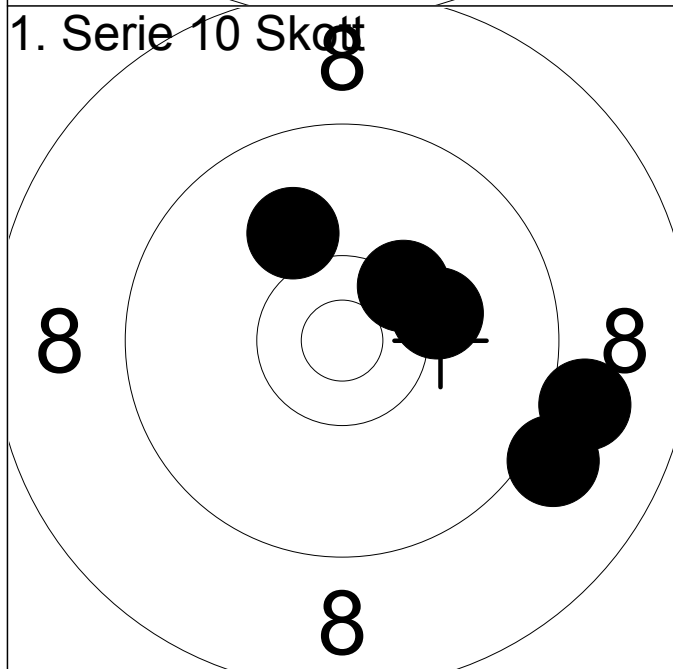

6:	9.0	→
7:	*10.3	↗
8:	10.1	↗
9:	9.1	↘
10:	10.2	→
Serie		48.0
Total		279.0

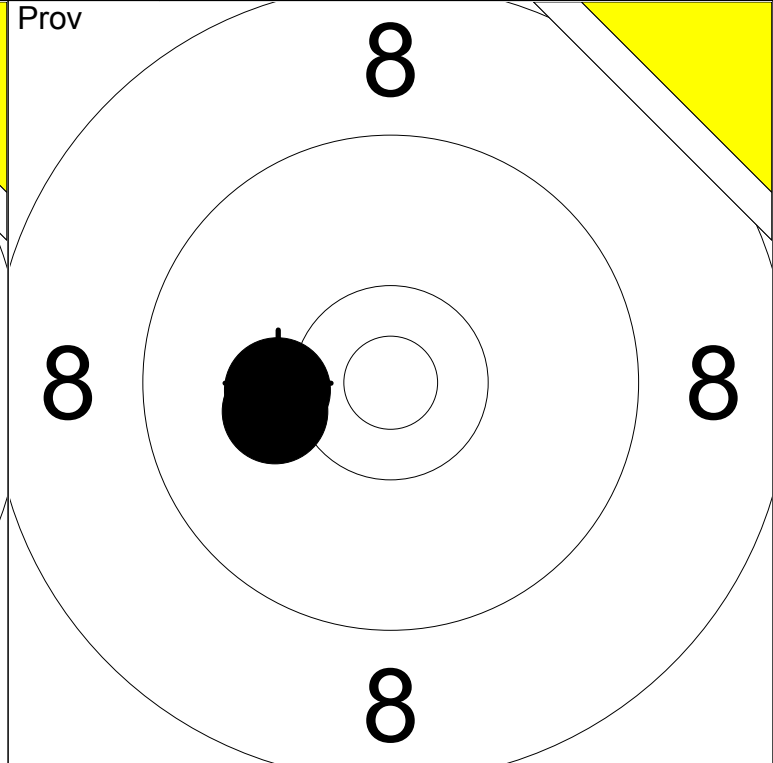
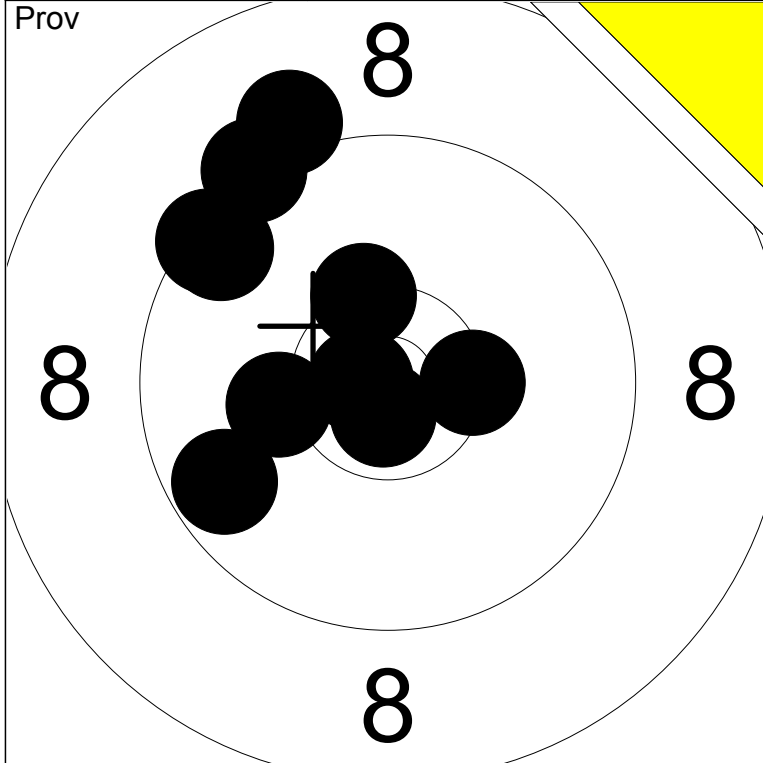

1: 9.1 ↗	6: *10.3 ↗	Serie	95.0
2: 10.2 ←	7: 9.5 ↘		
3: *10.8 ←	8: *10.7 ↓	Total	183.0
4: 9.4 ↗	9: *10.4 →		
5: 9.3 ↗	10: 9.7 ↙		

11: 10.2 ←	Serie	20.0
12: 10.2 ←		
Total		183.0

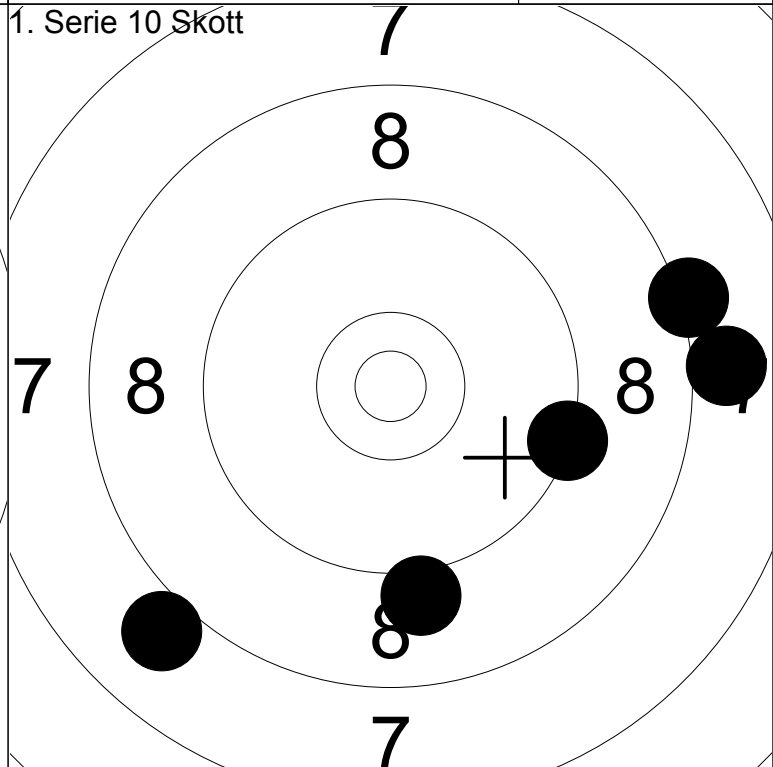
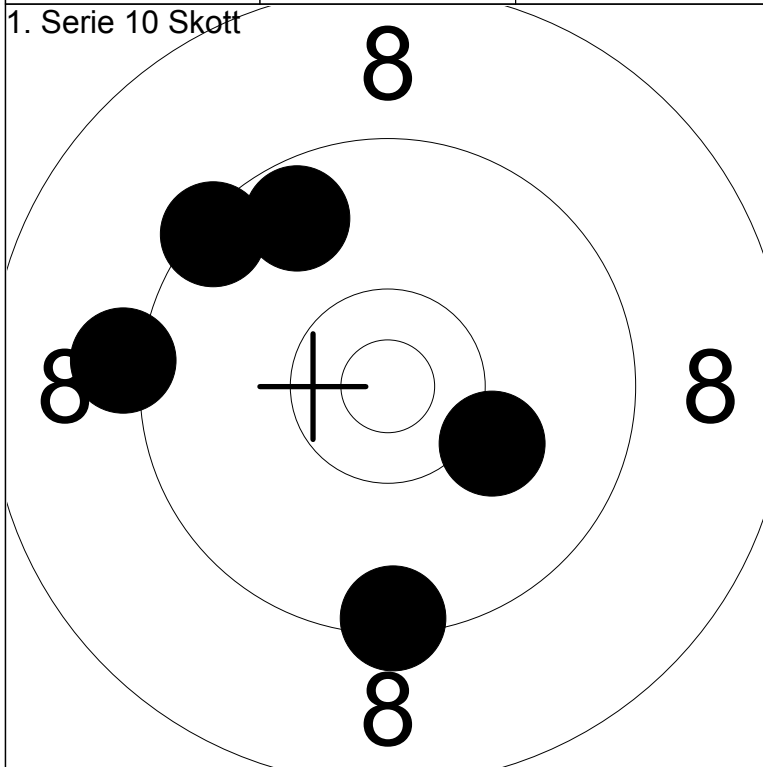

1: 9.2 ←	Serie	46.0
2: 9.4 ↓		
3: 10.2 ↘	Total	229.0
4: 9.7 ↗		
5: 9.4 ↗		

6: 8.2 →	Serie	42.0
7: 9.3 →		
8: 9.1 ↓	Total	271.0
9: 8.0 →		
10: 8.0 ↙		

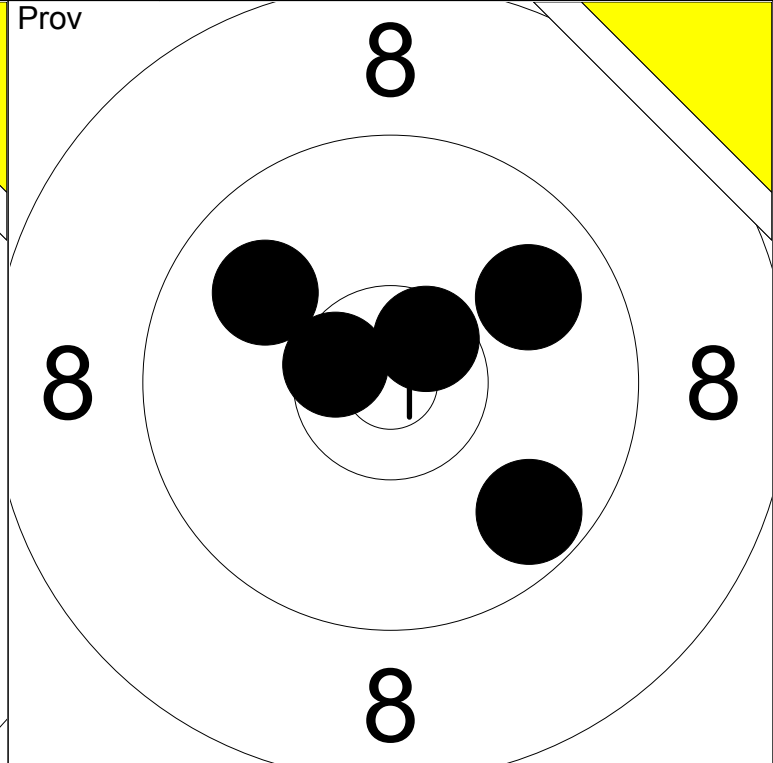
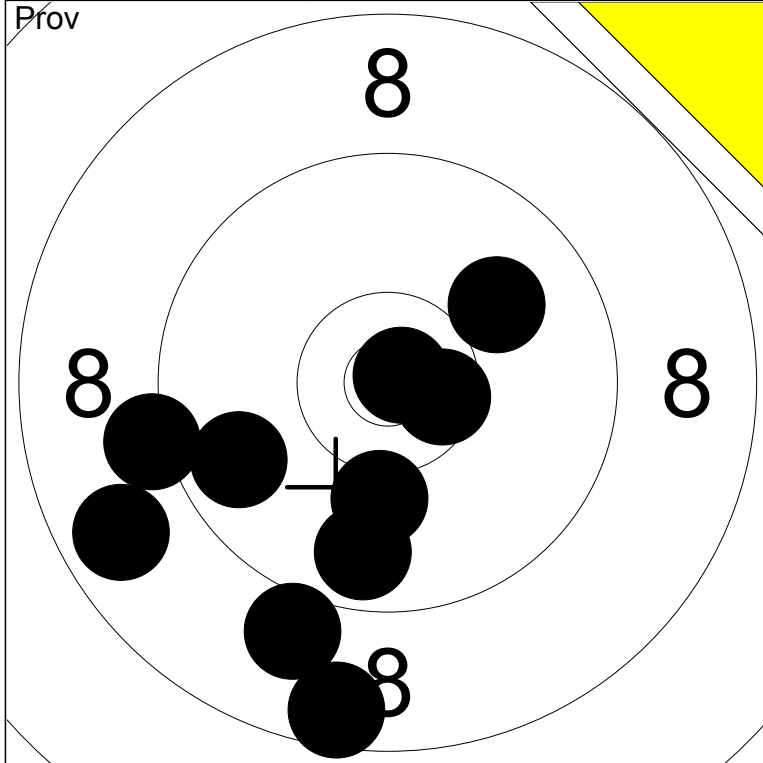

1: 9.2 ←	6: *10.8 ↗	Serie	92.0
2: 8.6 ↓	7: 9.7 ←		
3: 10.1 ↓	8: 9.0 ↓	Total	183.0
4: 9.7 ↓	9: 10.0 ↗		
5: *10.5 →	10: 8.8 ←		

11: 9.7 ↘	Serie	47.0
12: *10.6 ←		
13: *10.6 ↗	Total	183.0
14: 9.9 ↖		
15: 9.9 ↗		

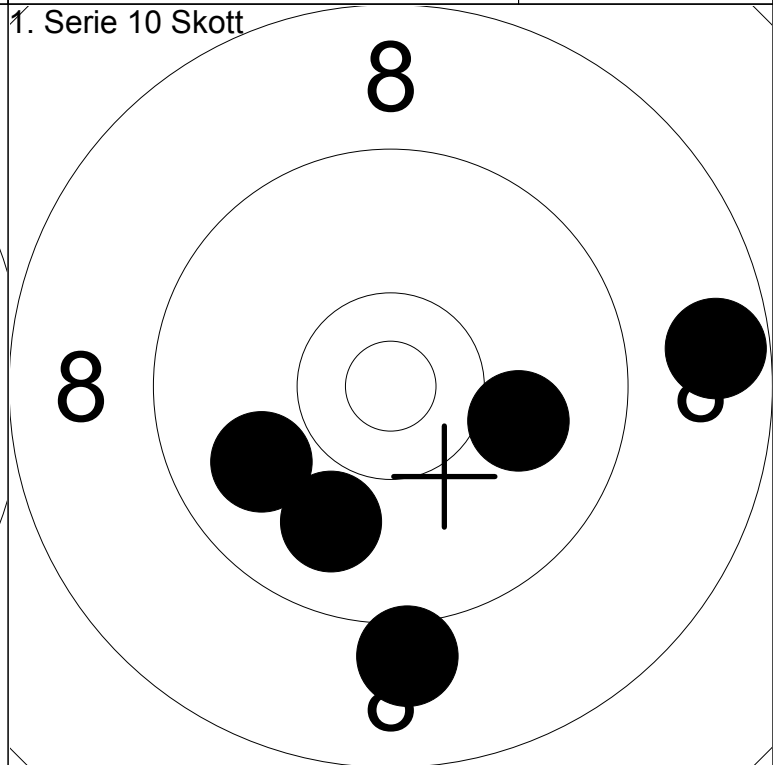
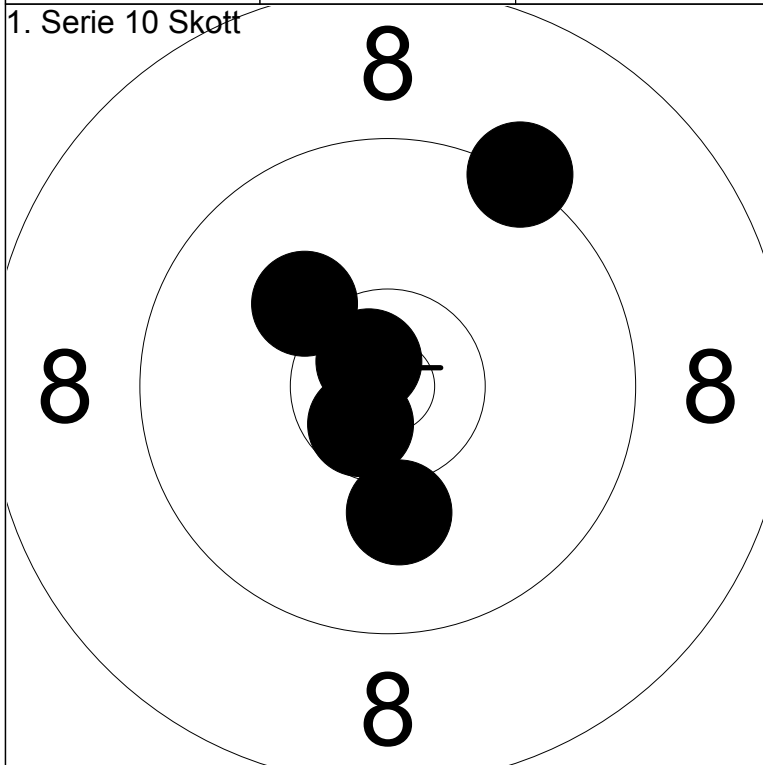

1: 10.2 ↖	Serie	49.0
2: *10.7 ↖		
3: *10.6 ↘	Total	232.0
4: 10.1 ↓		
5: 9.3 ↗		

6: 8.7 →	Serie	45.0
7: 9.1 ↓		
8: 9.9 ↓	Total	277.0
9: 9.9 ←		
10: 10.0 →		

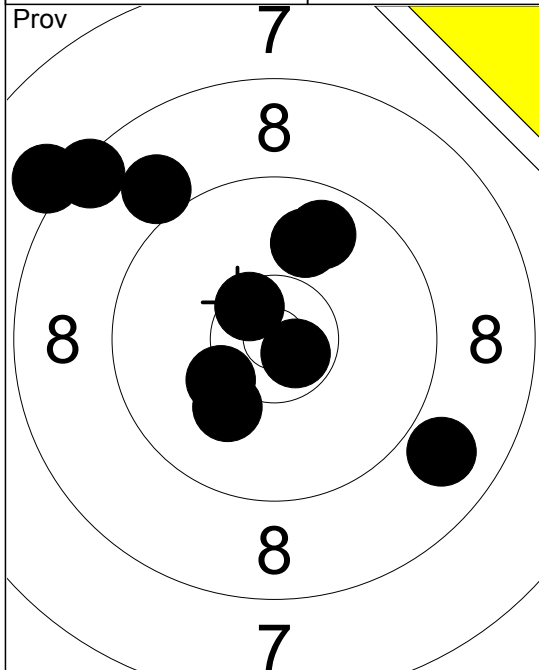

1:	8.1	↖
2:	10.1	↘
3:	9.0	↗
4:	8.4	↗
5:	9.8	↗
6:	9.9	↗
7:	10.3	↖
8:	8.9	↘
9:	*10.5	↗
10:	*10.7	↘
Serie	91.0	
Total	183.0	

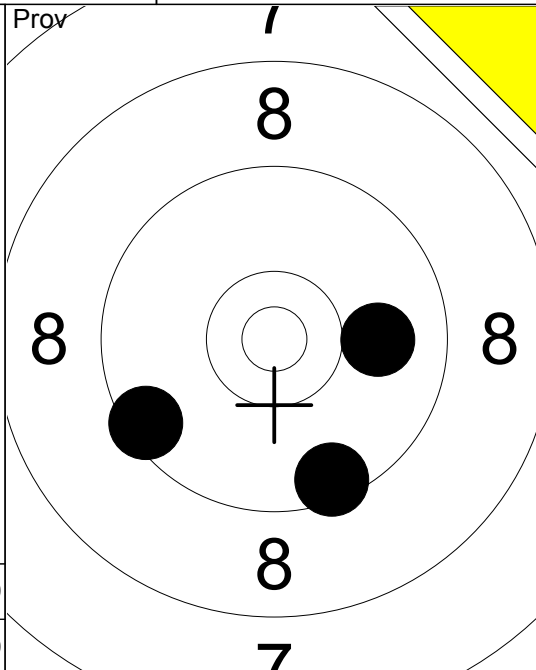

11:	10.0	→
12:	9.5	↘
13:	9.5	↖
Serie	28.0	
Total	183.0	

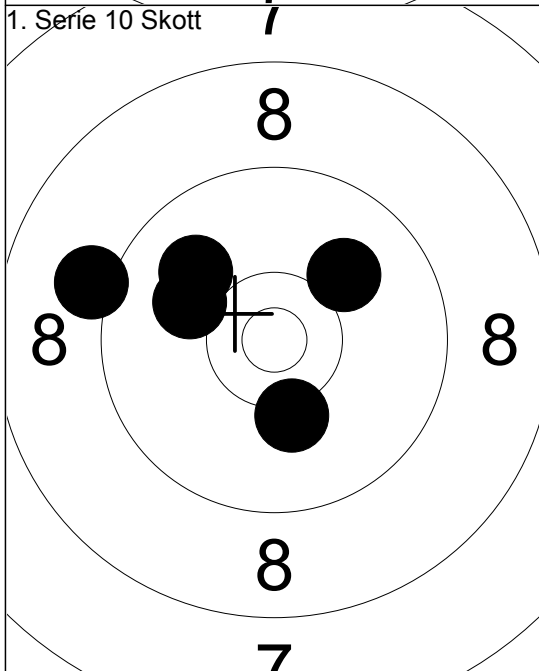

1:	9.1	↖
2:	10.0	↗
3:	10.0	↗
4:	10.1	↖
5:	10.2	↘
Serie	49.0	
Total	232.0	

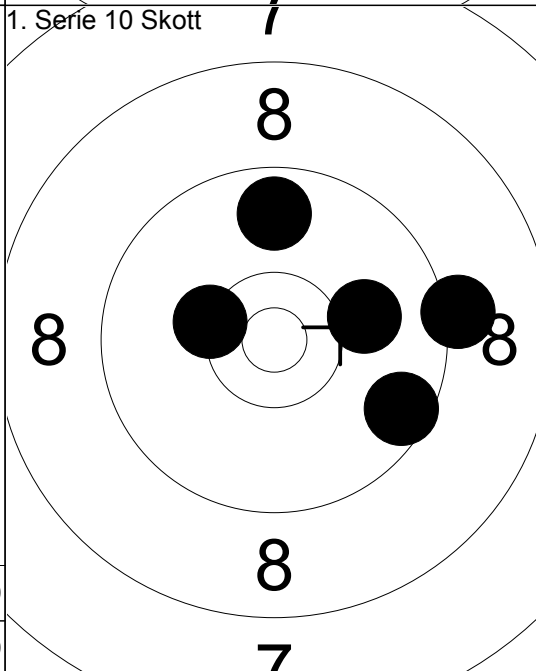

6:	9.6	↘
7:	9.7	↑
8:	10.1	→
9:	*10.3	↖
10:	9.2	→
Serie	47.0	
Total	279.0	

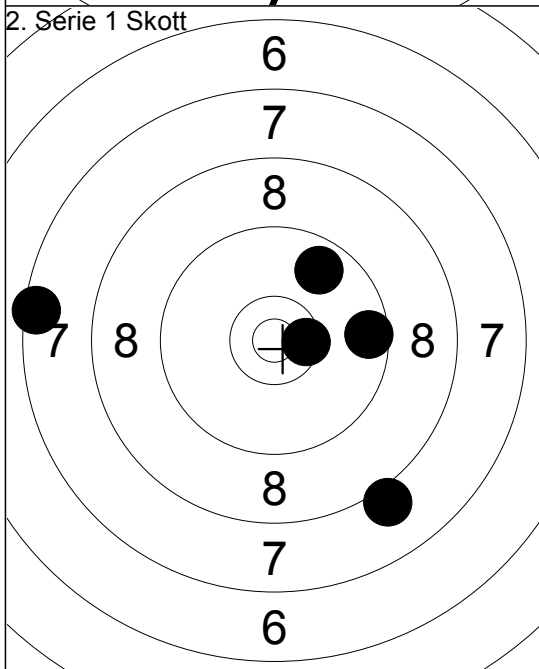

1:	7.5	←
2:	*10.5	→
3:	9.6	→
4:	9.7	↗
5:	8.1	↘
Serie	43.0	
Total	322.0	

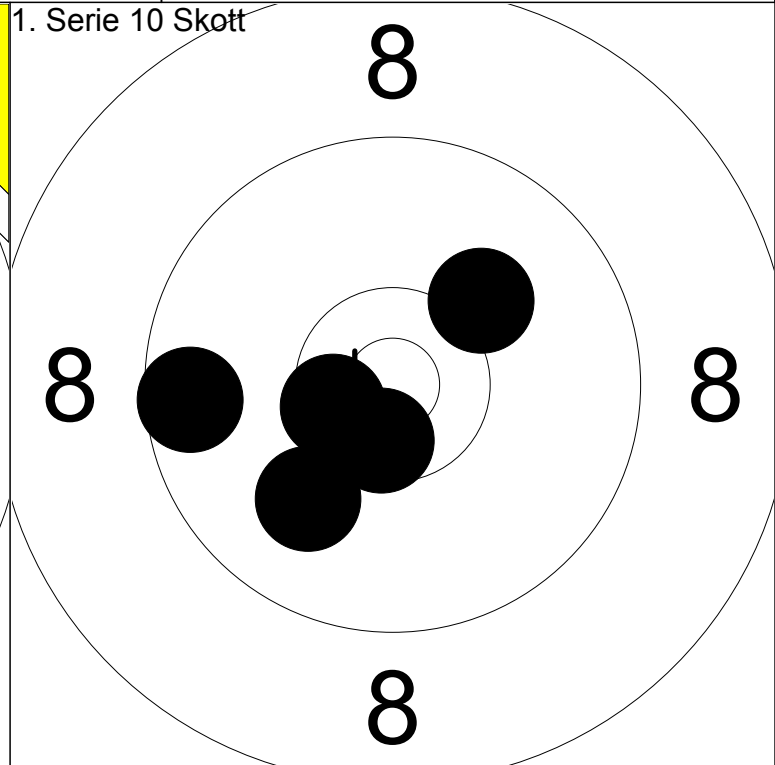
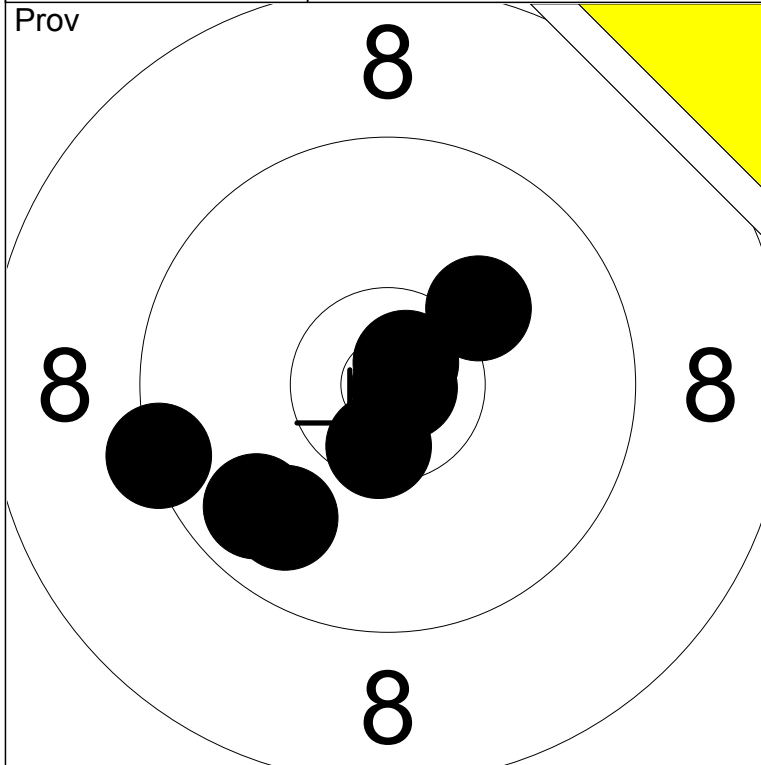

1: 9.4 ←	6: 9.8 ↘	Serie	67.0
2: *10.8 →	7: *10.5 ↓		
3: 9.8 ↙		Total	181.0
4: 10.2 ↗			
5: *10.8 ↗			

1: 9.6 ←	Serie	49.0
2: *10.5 ←		
3: 10.0 ↙	Total	230.0
4: 10.1 ↗		
5: *10.6 ↓		

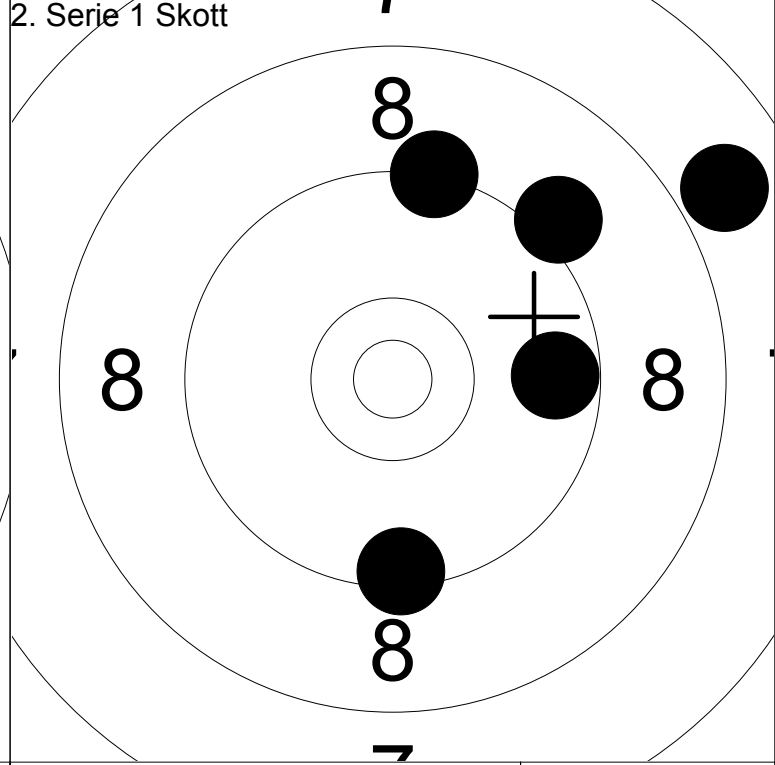
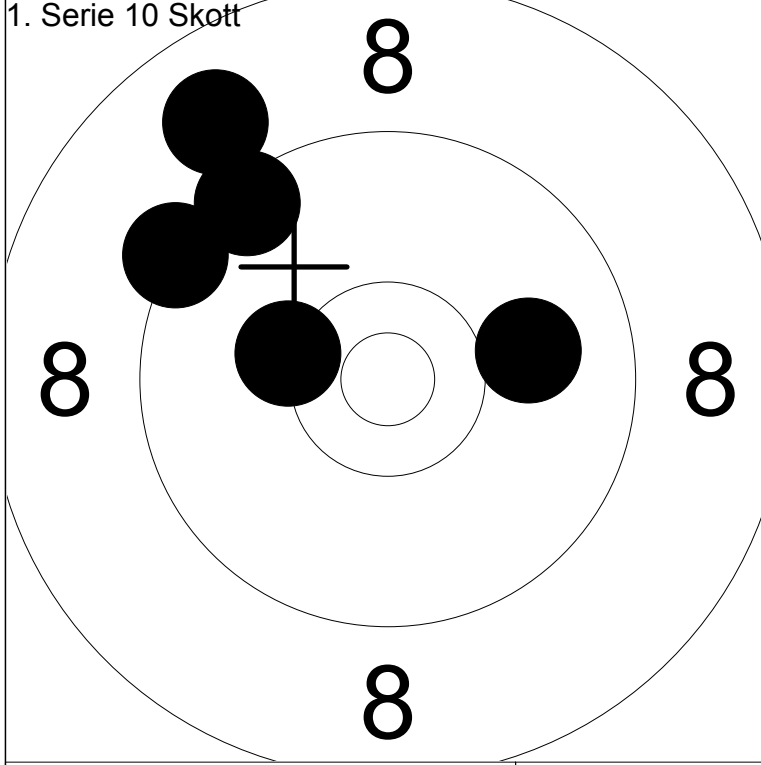

6: 8.9 ↗	Serie	46.0
7: 10.0 →		
8: 9.4 ↗	Total	276.0
9: 9.3 ↗		
10: 10.3 ←		

1: 7.9 ↗	Serie	43.0
2: 9.7 →		
3: 9.4 ↓	Total	319.0
4: 9.3 ↑		
5: 9.1 ↗		

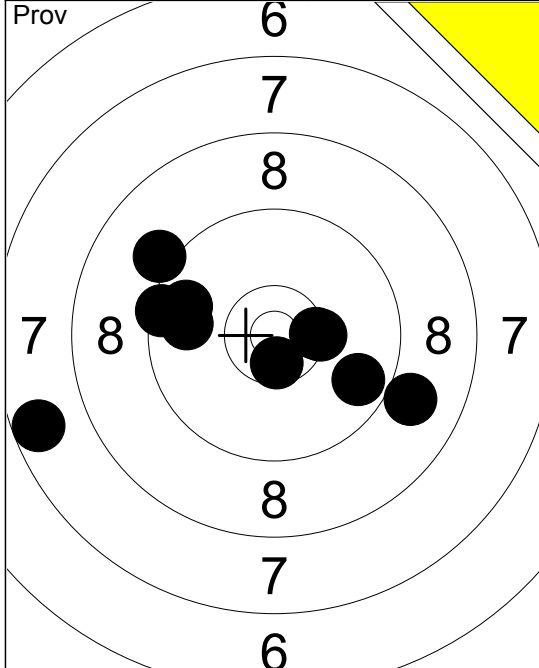

1:	9.7	↖
2:	9.7	↘
3:	9.8	↖
4:	9.4	↖
5:	7.6	↖
6:	*10.3	→
7:	9.0	↘
8:	*10.4	→
9:	*10.6	↓
10:	9.1	↖
Serie	91.0	
Total	178.0	

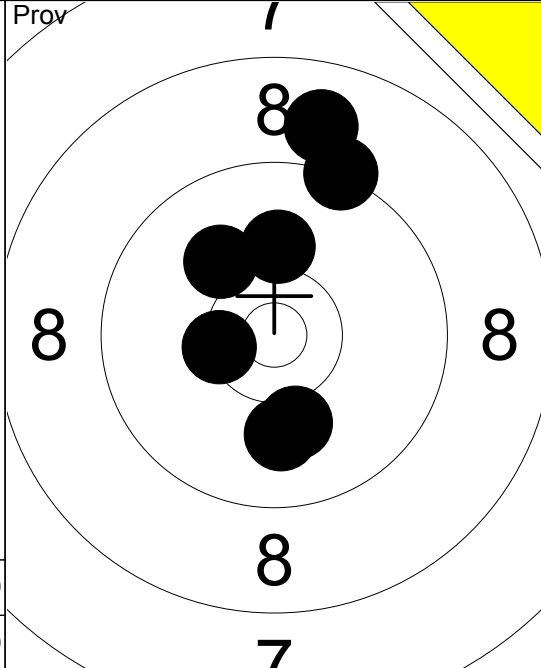

11:	10.1	↓
12:	9.3	↗
13:	10.0	↓
14:	*10.4	↖
15:	10.1	↗
16:	8.9	↗
17:	10.1	↖
Serie	67.0	
Total	178.0	

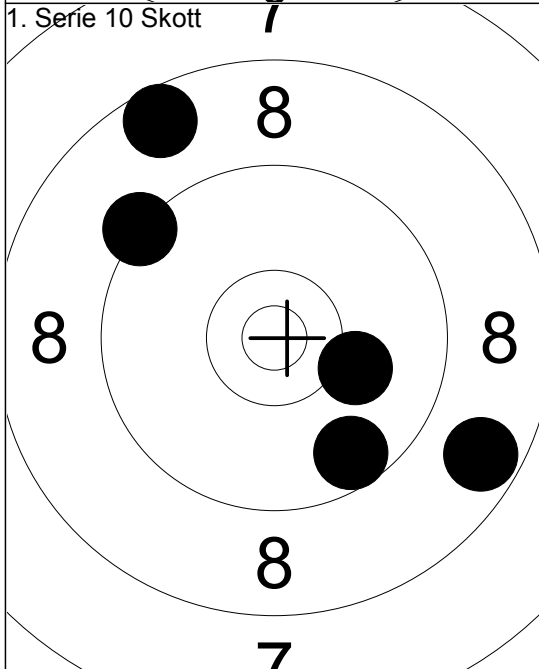

1:	9.3	↗
2:	8.6	↗
3:	8.7	↘
4:	10.1	↘
5:	9.6	↘
Serie	44.0	
Total	222.0	

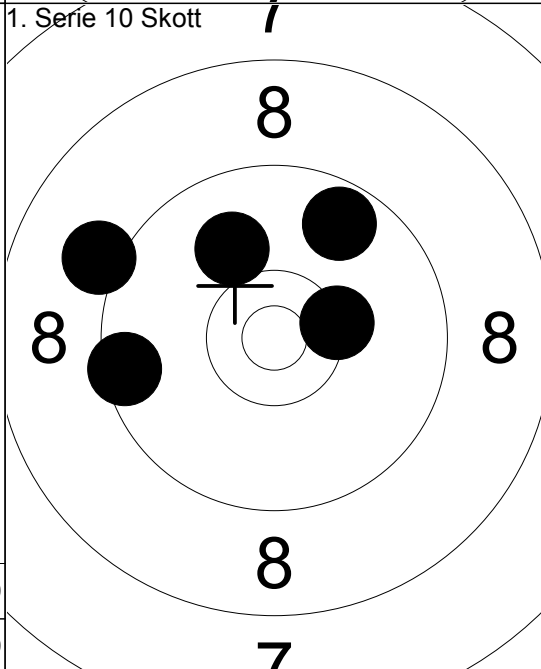

6:	9.7	↗
7:	9.5	↖
8:	*10.3	→
9:	9.1	↖
10:	10.0	↗
Serie	47.0	
Total	269.0	

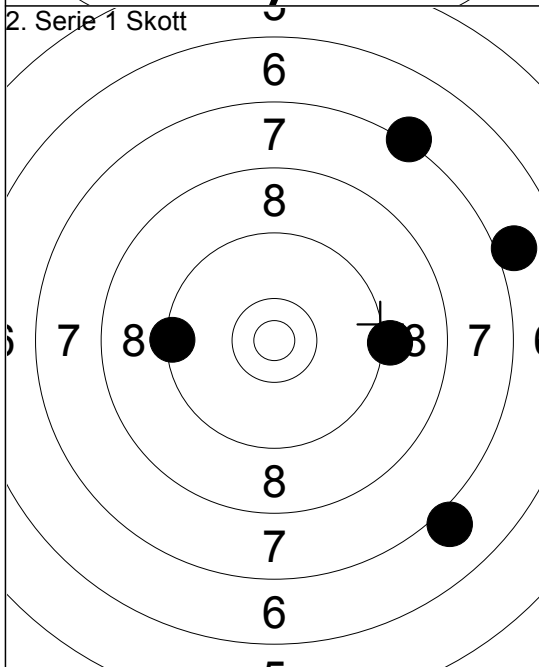

1:	7.2	↗
2:	7.0	→
3:	9.4	↖
4:	7.1	↘
5:	9.2	→
Serie	39.0	
Total	308.0	

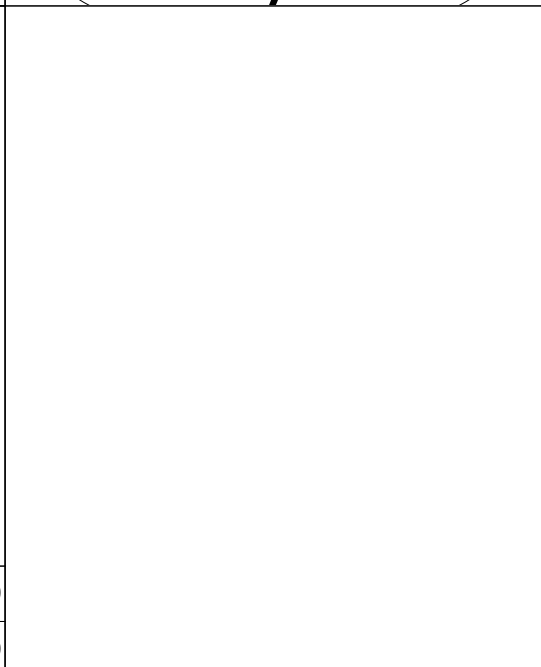

Serie		
Total		

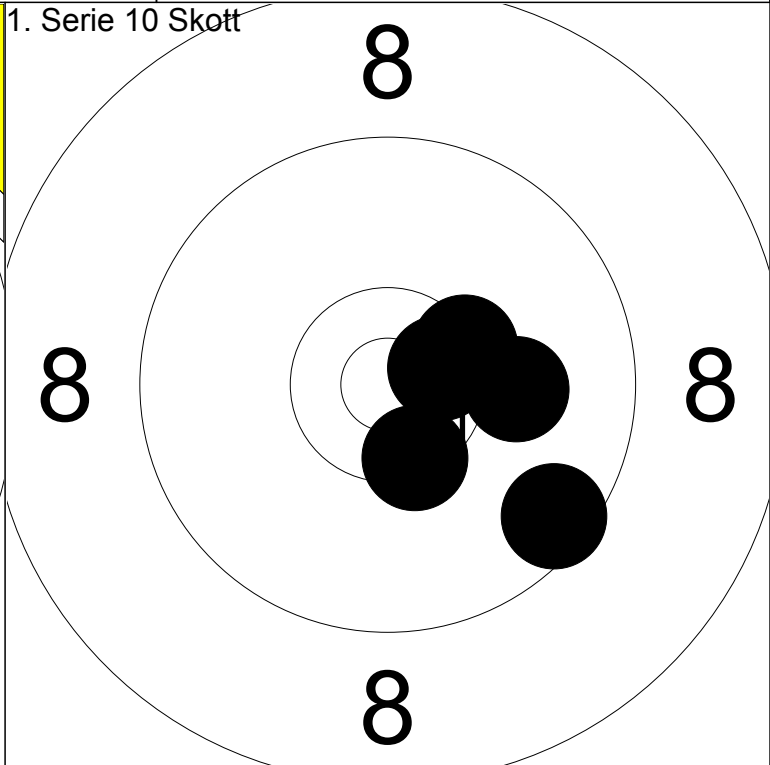
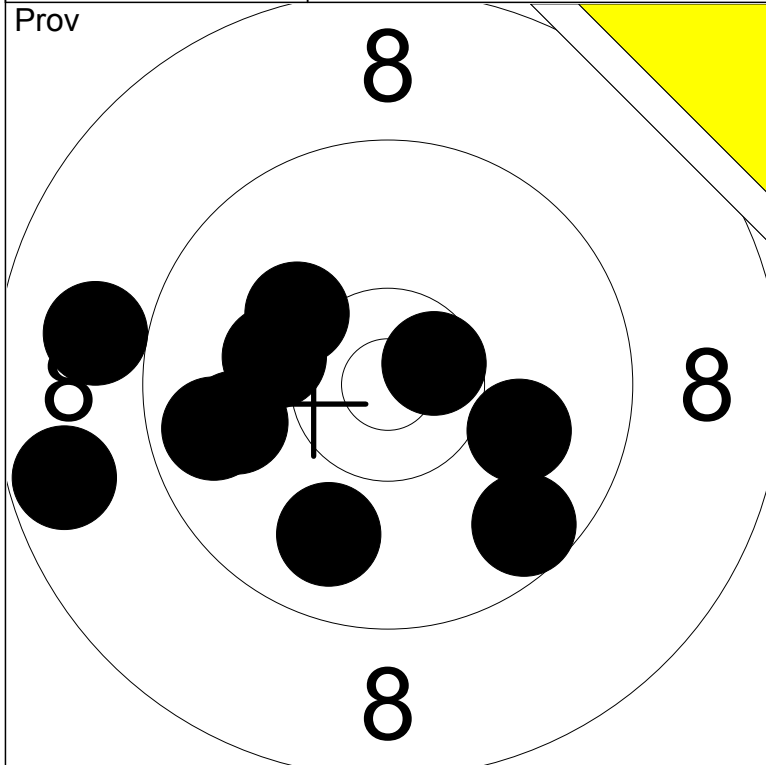

1: 10.2 ↖	6: 9.9 ↓	Serie	92.0
2: 9.7 ←	7: 8.9 ←		
3: *10.6 →	8: 9.9 ←	Total	178.0
4: 8.7 ←	9: 9.6 ↓		
5: 10.2 ←	10: 10.0 →		

1: 10.1 →	Serie	49.0
2: *10.6 →		
3: *10.4 →	Total	227.0
4: 9.5 ↓		
5: *10.4 ↓		

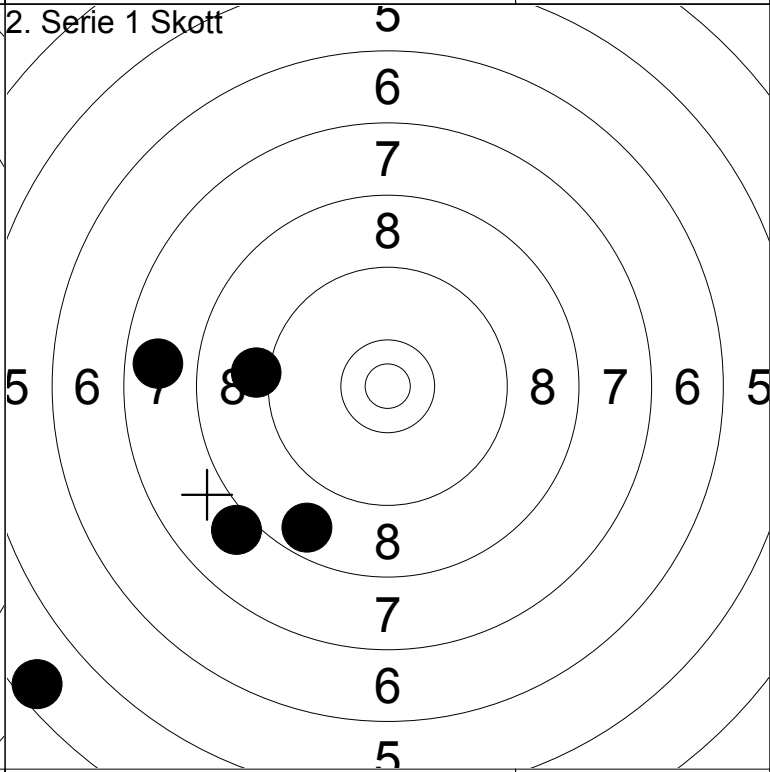
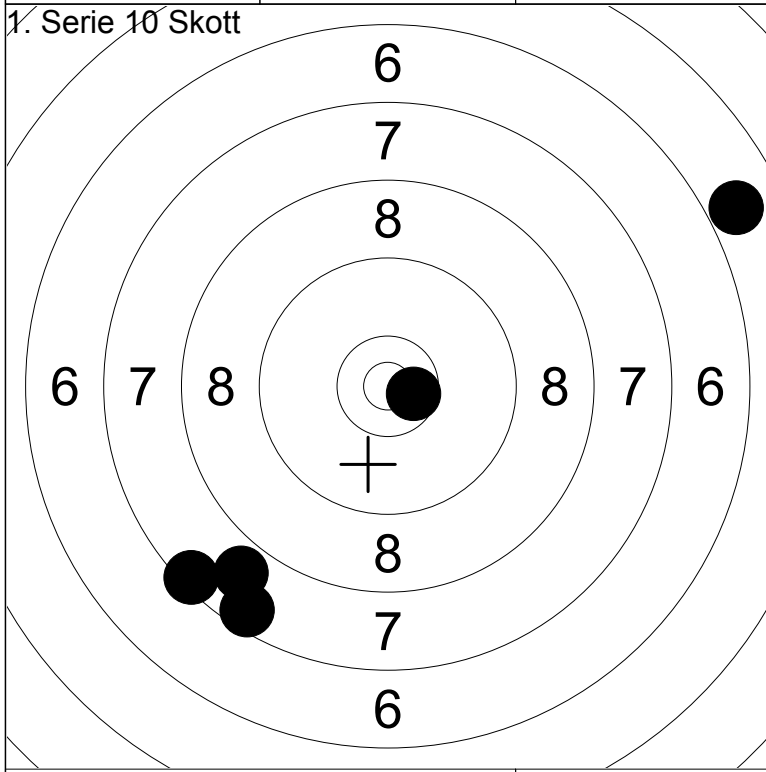

6: 5.9 ↗	Serie	36.0
7: 7.4 ↙		
8: *10.6 →	Total	263.0
9: 7.6 ↓		
10: 7.9 ↙		

1: 8.7 ↓	Serie	36.0
2: 9.1 ←		
3: 8.1 ↓	Total	299.0
4: 4.6 ↙		
5: 7.8 ←		

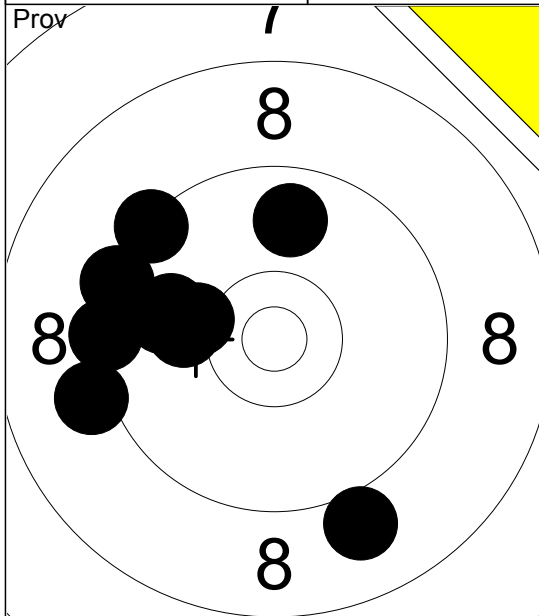

- 1: 9.9 ←
- 2: 9.9 ←
- 3: 9.0 ↘
- 4: 10.1 ←
- 5: 9.4 ↗
- 6: 9.4 ↗
- 7: 9.3 ←
- 8: 10.2 ←
- 9: 9.8 ↑
- 10: 9.1 ←

Serie 92.0
Total 169.0

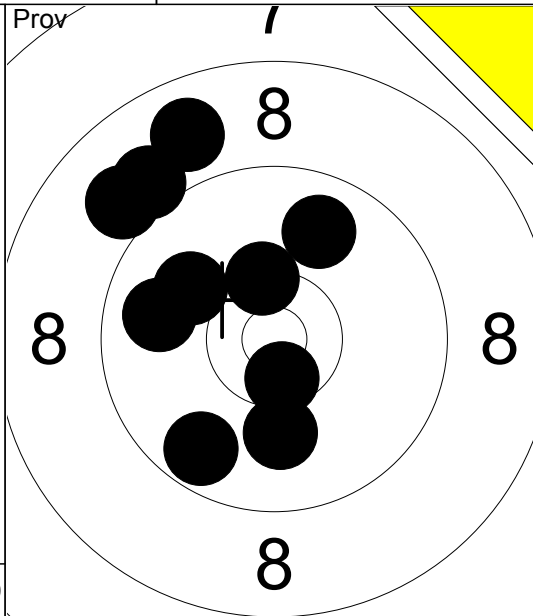

- 11: 10.1 ↓
- 12: 10.0 ↖
- 13: 9.0 ↗
- 14: *10.4 ↗
- 15: 9.7 ↘
- 16: 9.8 ↗
- 17: *10.6 ↓
- 18: 9.0 ↖
- 19: 9.8 ←
- 20: 8.8 ↗

Serie 93.0
Total 169.0

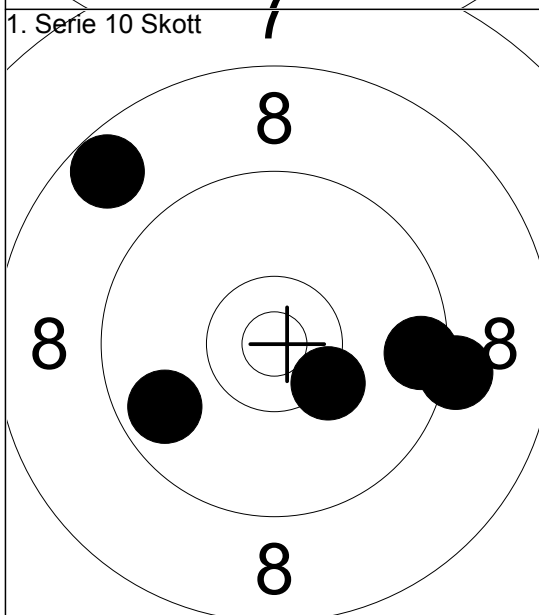

- 1: 8.7 ↗
- 2: 9.7 ↖
- 3: 9.5 →
- 4: 9.2 →
- 5: *10.3 ↘

Serie 45.0
Total 214.0

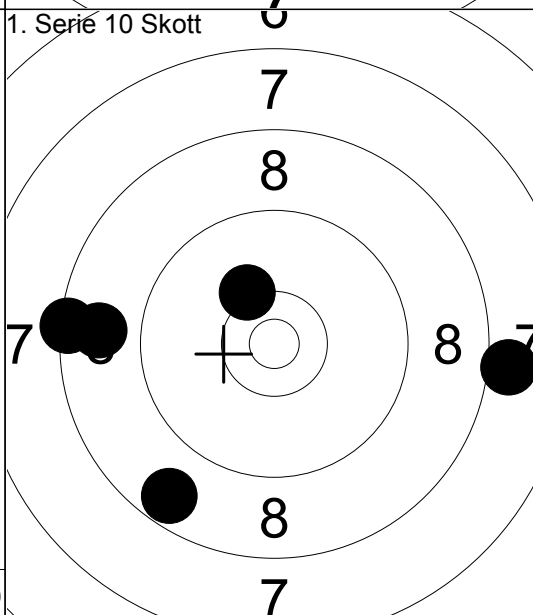

- 6: 8.0 →
- 7: 8.7 ↘
- 8: 10.2 ↗
- 9: 8.8 ←
- 10: 8.4 ←

Serie 42.0
Total 256.0

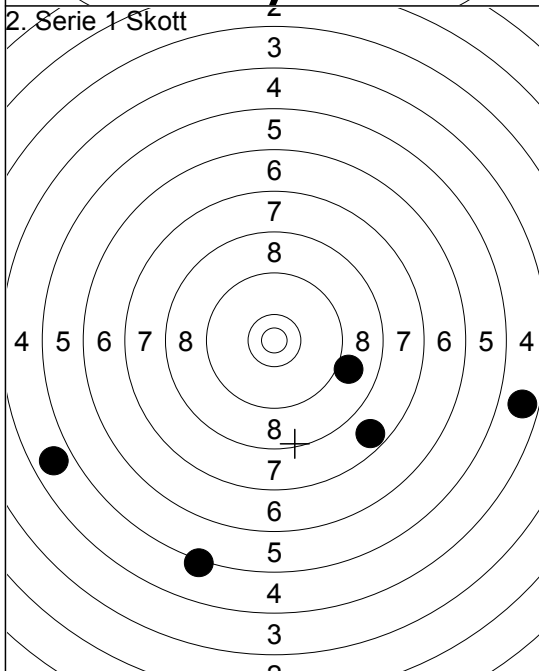

- 1: 4.8 ←
- 2: 5.2 ↘
- 3: 4.7 →
- 4: 9.0 ↘
- 5: 7.7 ↘

Serie 29.0
Total 285.0

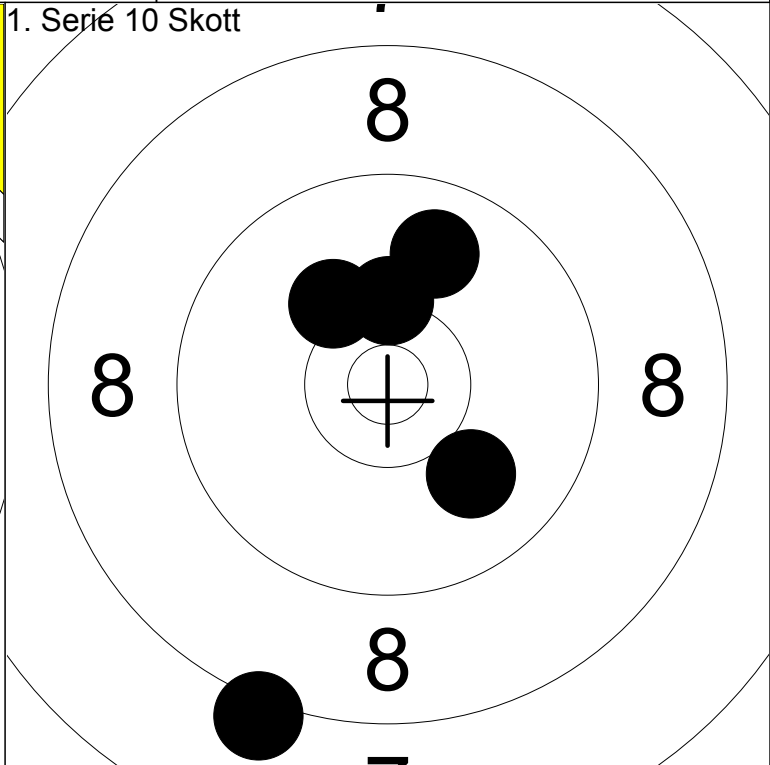
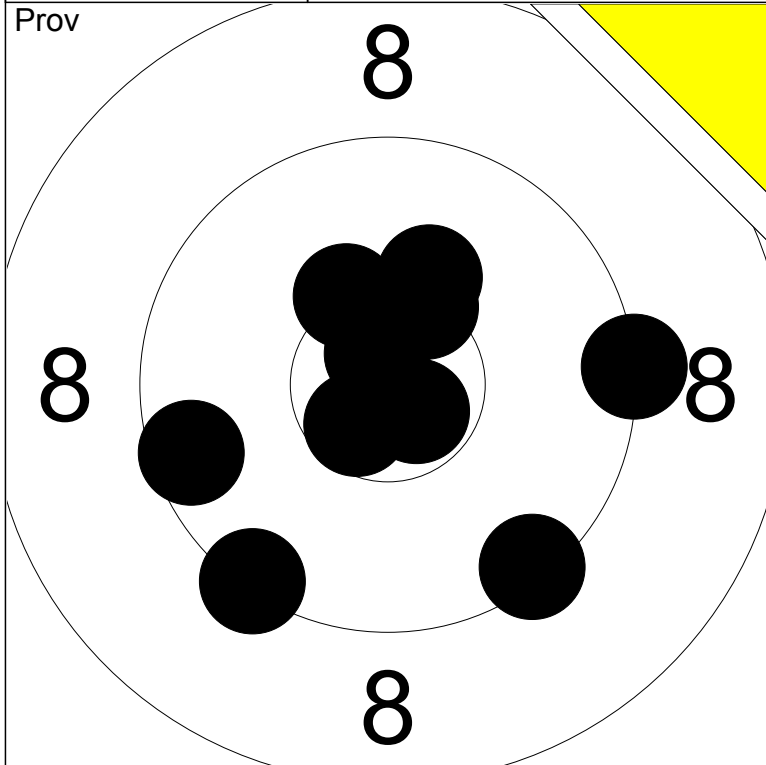

1: *10.7 ↘	6: *10.3 ↗	Serie	96.0
2: *10.4 ↗	7: 9.6 ←		
3: 10.2 ↗	8: 9.3 →	Total	162.0
4: *10.6 ↘	9: 9.4 ↘		
5: 9.4 ↘	10: *10.7 ↗		

1: 10.2 ↗	Serie	47.0
2: 8.2 ↘		
3: 10.0 ↘	Total	209.0
4: *10.3 ↗		
5: 9.9 ↗		

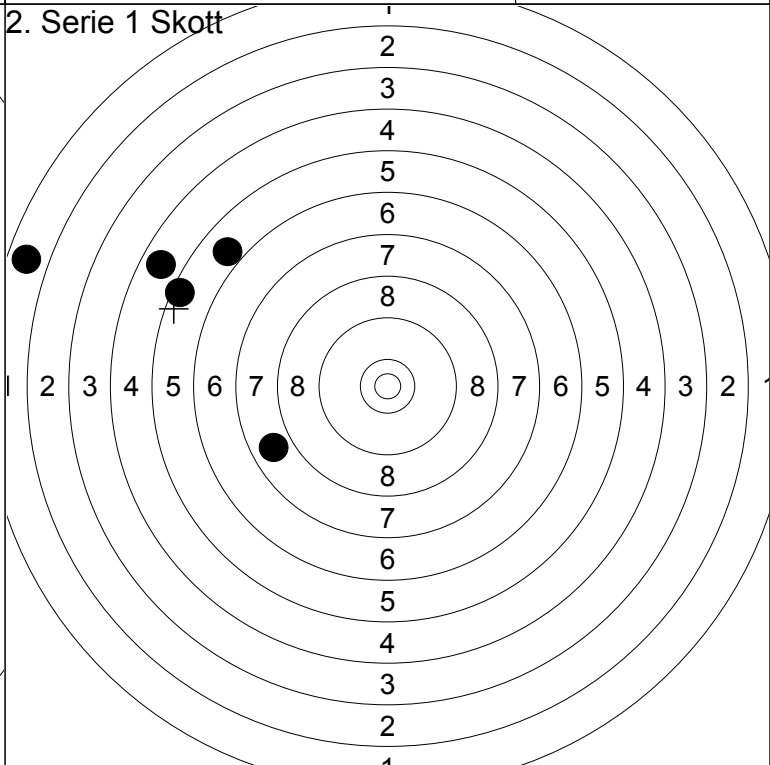
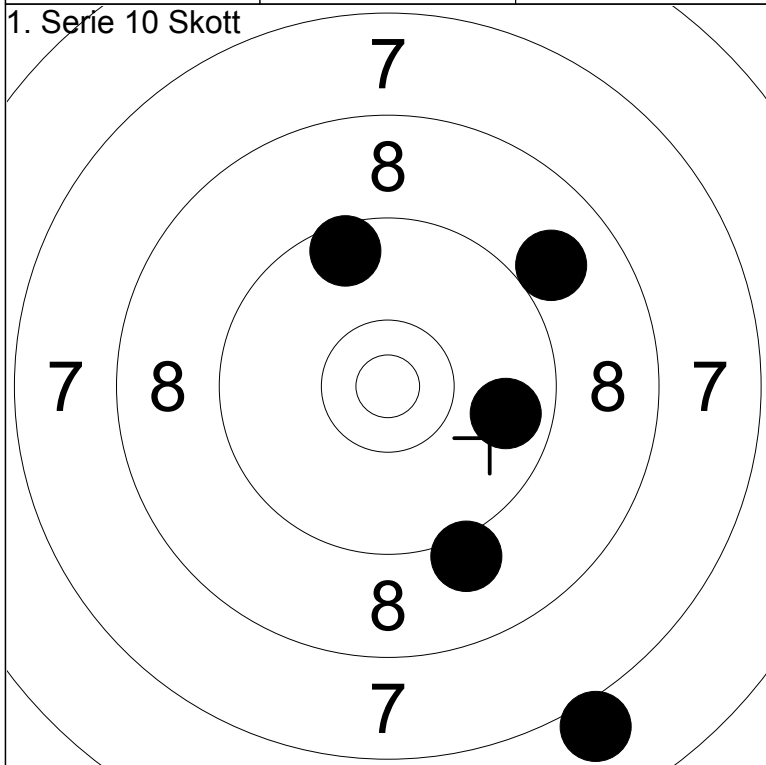

6: 9.1 ↘	Serie	43.0
7: 7.1 ↘		
8: 9.8 →	Total	252.0
9: 9.0 ↗		
10: 9.6 ↗		

1: 1.8 ←	Serie	22.0
2: 4.8 ←		
3: 5.5 ←	Total	274.0
4: 7.8 ←		
5: 5.9 ↗		

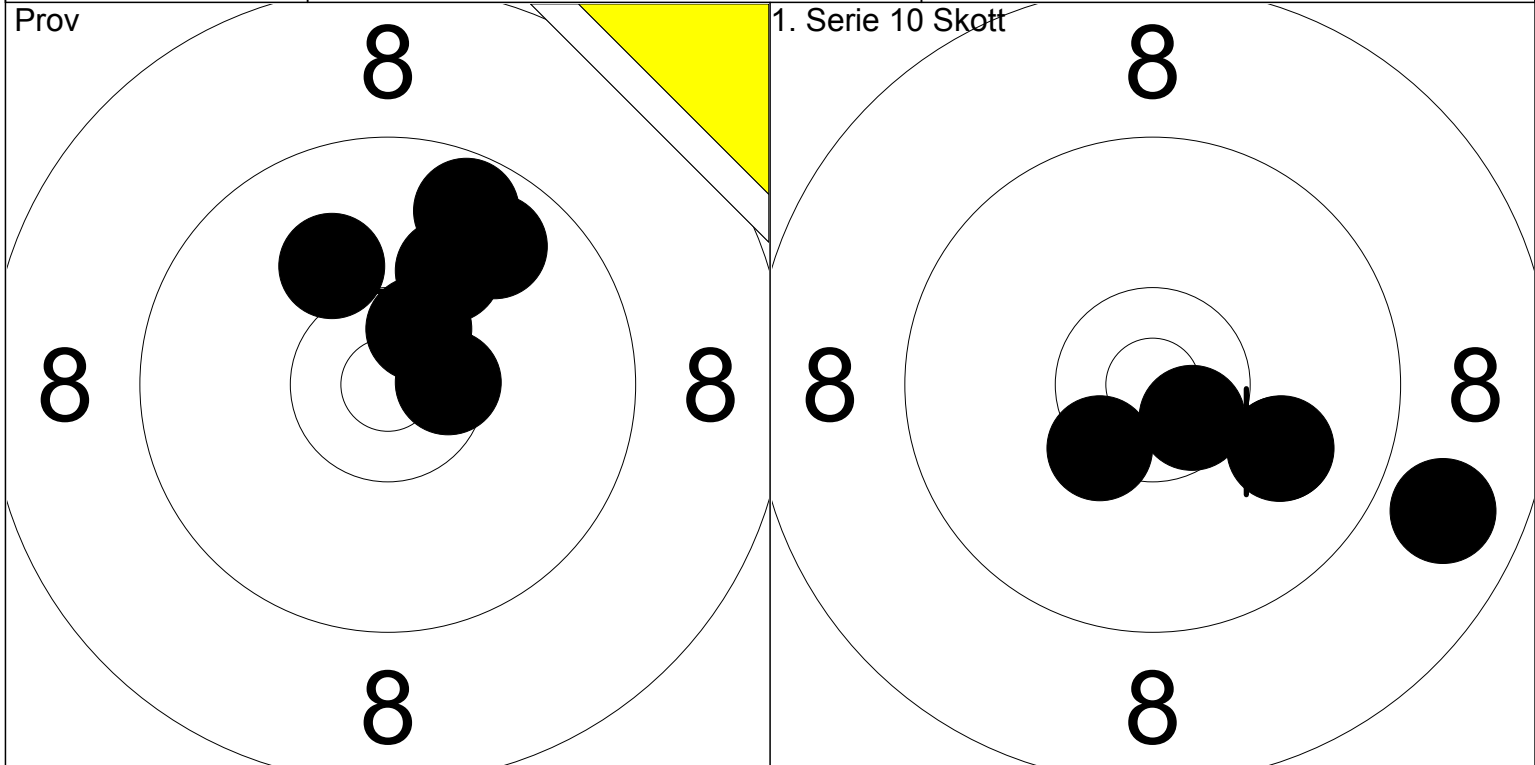

1: 10.1 ↖	6: 9.7 ↗	Serie	58.0	1: *10.4 ↘	Serie	48.0
2: *10.5 →		Total	188.0	2: 10.0 ↘	Total	236.0
3: *10.5 ↗				3: 10.0 ↘		
4: 10.1 ↗				4: 8.8 ↘		
5: 9.8 ↗				5: *10.6 ↘		

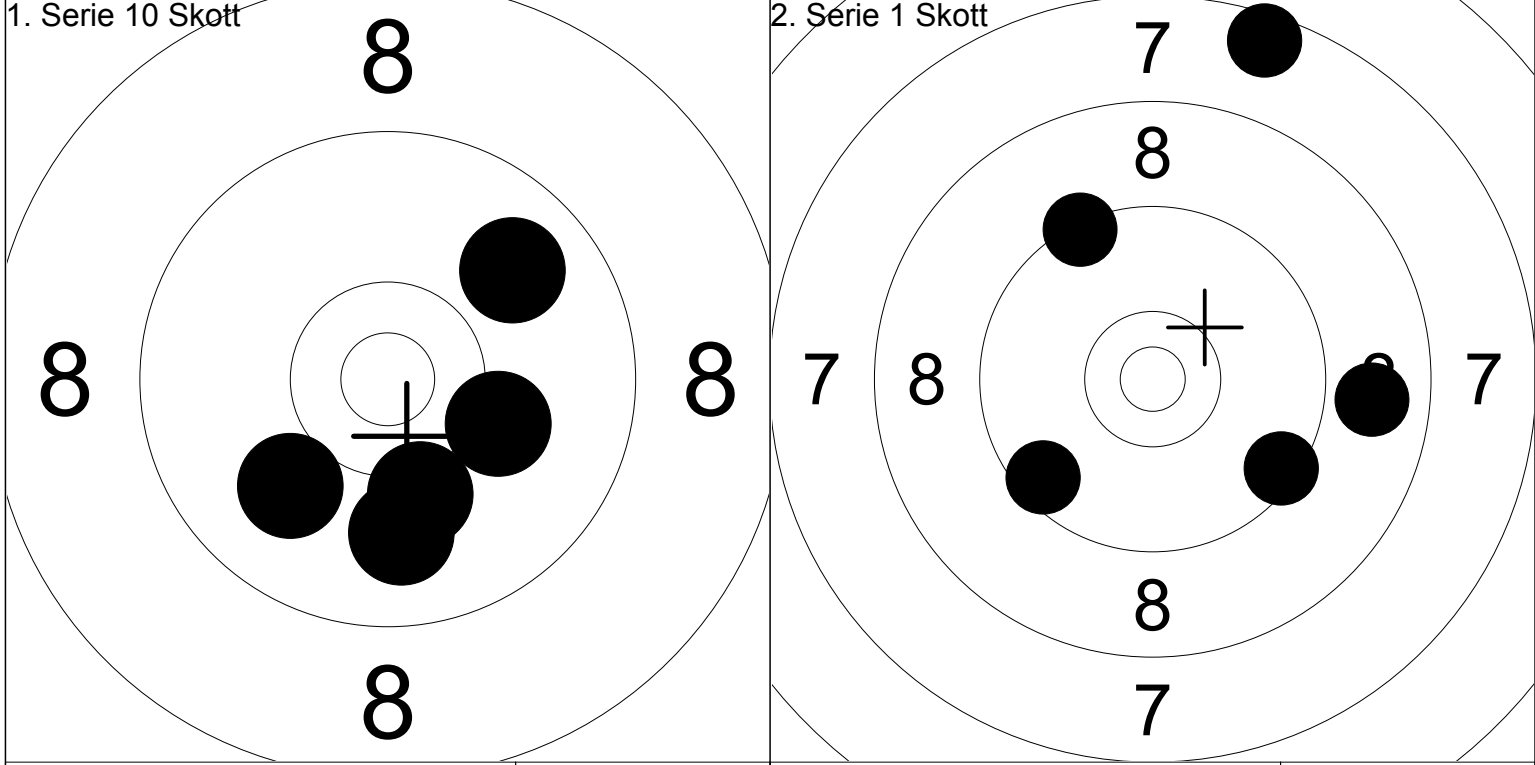

6: 10.2 →	1: 7.6 ↖	Serie	48.0	2: 8.9 →	Serie	42.0
7: 10.0 ↘		Total	284.0	3: 9.5 ↘	Total	326.0
8: 9.8 ↗				4: 9.4 ↗		
9: 9.9 ↘				5: 9.5 ↘		
10: 10.2 ↘						

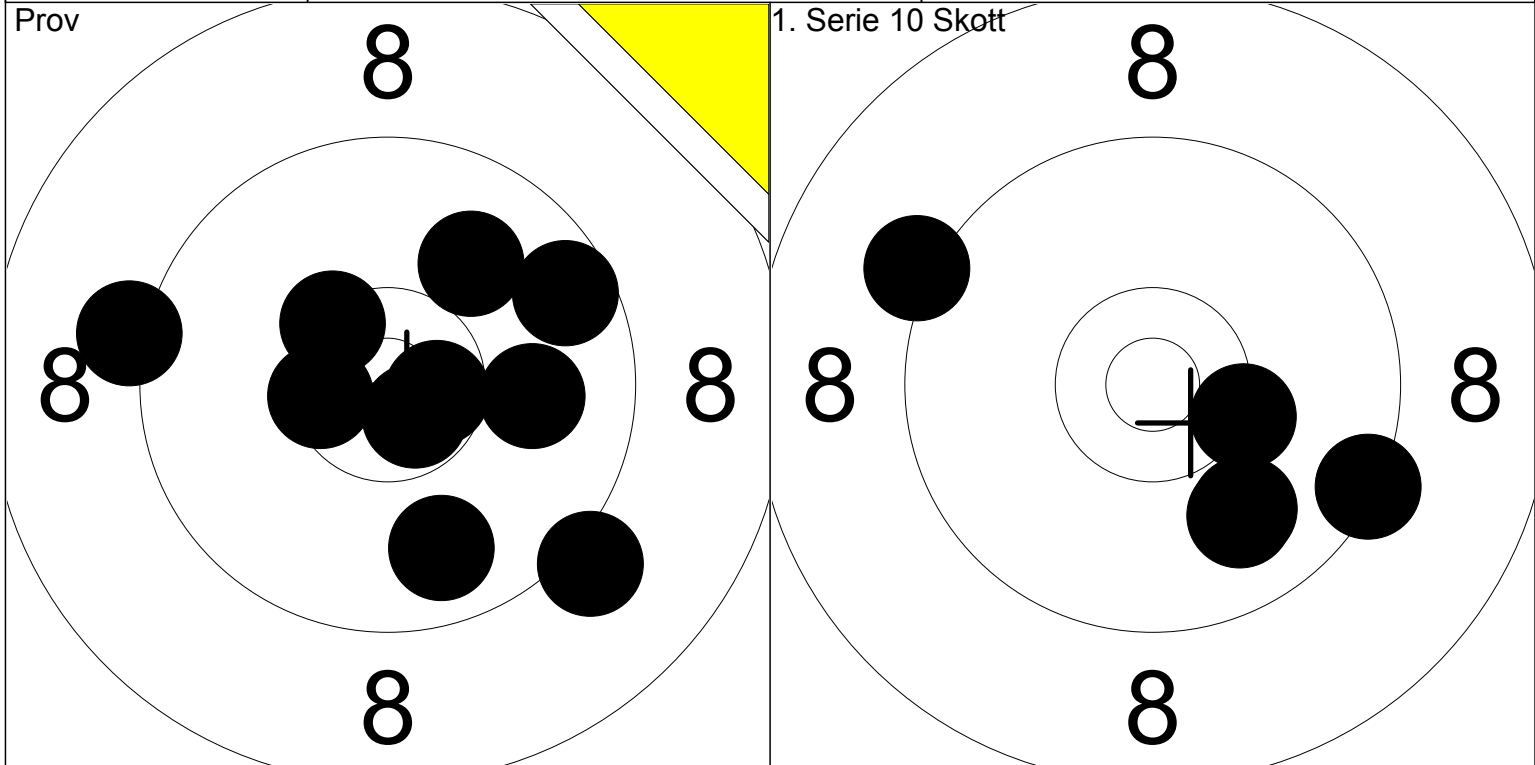

1: *10.5 ←	6: 10.0 ↗		1: 9.2 ↗	
2: 9.6 ↗	7: 9.2 ↘	Serie	2: *10.3 ↘	Serie
3: 10.0 →	8: *10.4 ↗		3: 9.4 ↘	
4: 9.8 ↓	9: *10.7 ↘	Total	4: 9.9 ↘	Total
5: *10.6 →	10: 9.2 ←	96.0	5: 9.9 ↘	46.0
		185.0		231.0

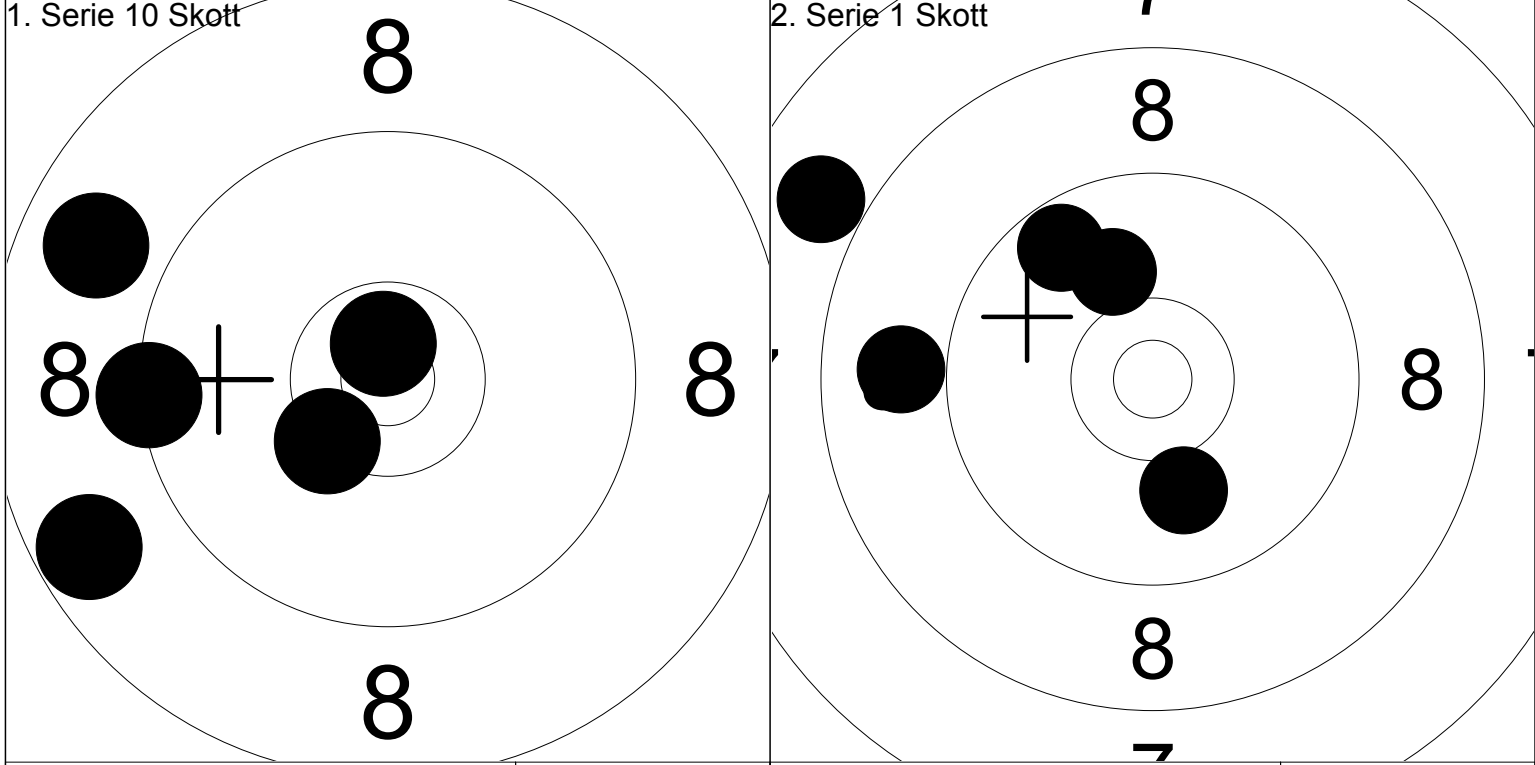

6: 8.8 ↖	1: 9.7 ↗		2: 10.0 ↘	
7: *10.4 ↘	2: 10.0 ↘	Serie	3: 10.0 ↗	Serie
8: 9.4 ←	3: 10.0 ↗		4: 7.9 ↗	
9: *10.7 ↑	4: 7.9 ↗	Total	5: 8.9 ←	Total
10: 8.7 ←	5: 8.9 ←	45.0		44.0
		276.0		320.0

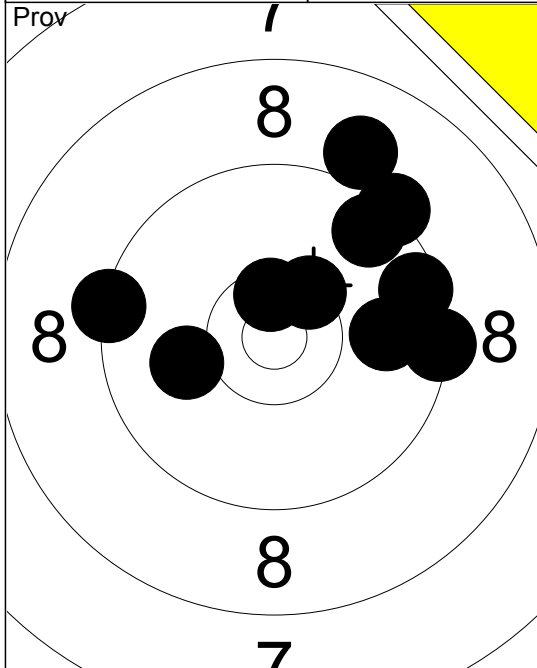

1:	9.9	→
2:	9.5	→
3:	9.4	→
4:	9.3	↗
5:	10.1	←
6:	9.6	↗
7:	*10.4	↗
8:	9.0	↗
9:	9.3	←
10:	*10.5	↑
Serie	93.0	
Total	180.0	

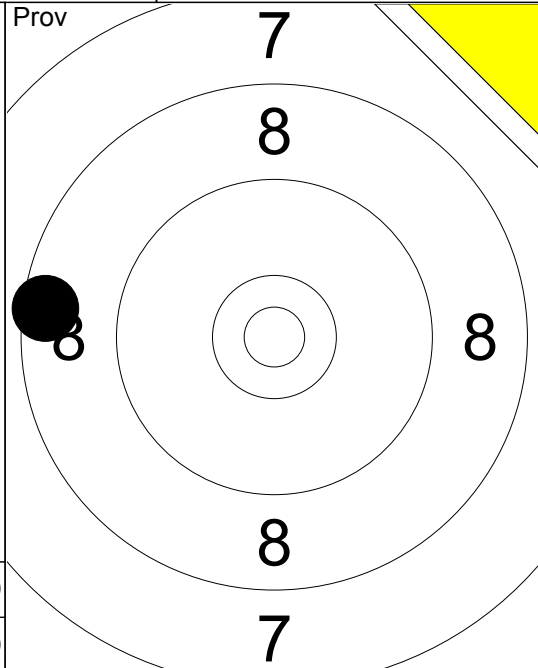

11:	8.5	←
Serie	8.0	
Total	180.0	

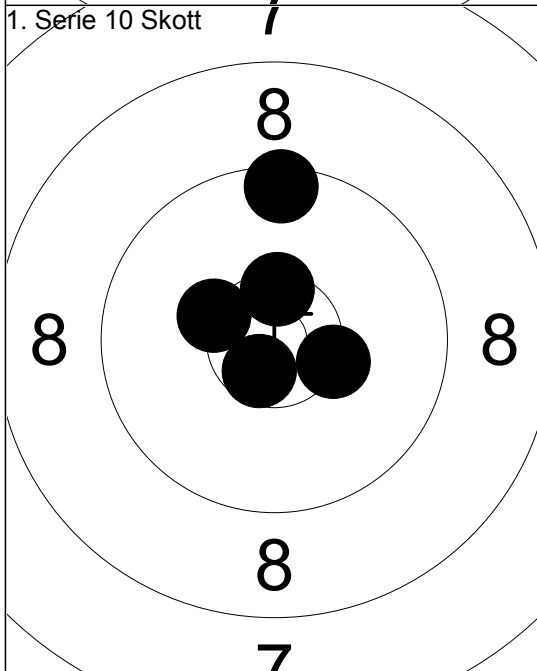

1:	*10.3	→
2:	*10.3	←
3:	*10.5	↑
4:	9.5	↑
5:	*10.6	↘
Serie	49.0	
Total	229.0	

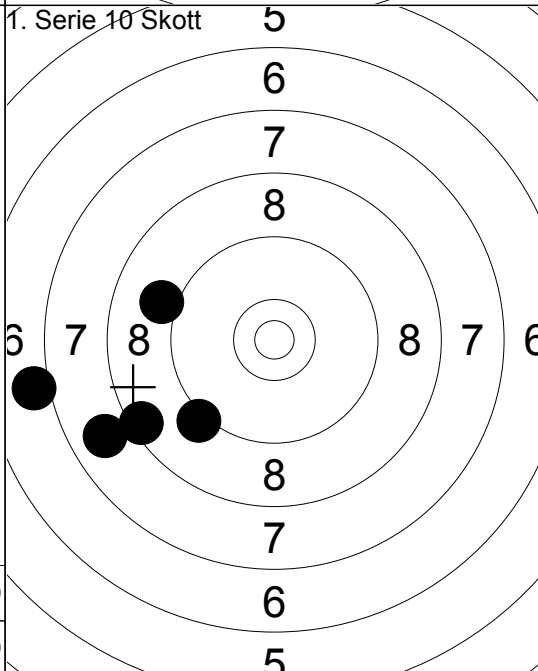

6:	7.9	←
7:	7.1	←
8:	8.5	←
9:	9.1	←
10:	9.2	↘
Serie	40.0	
Total	269.0	

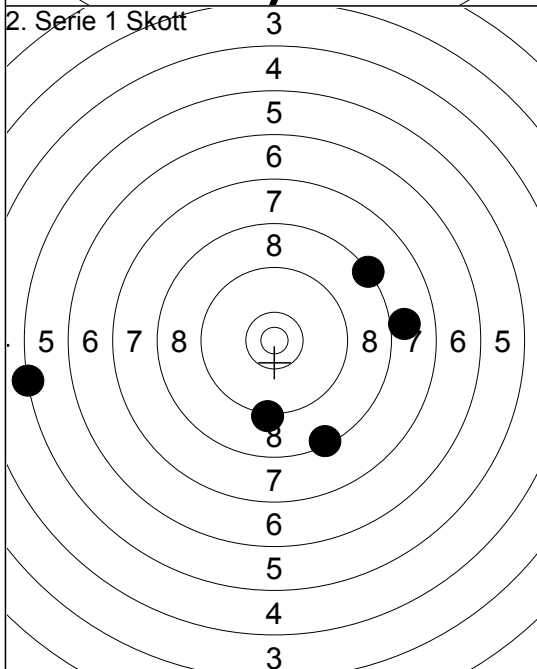

1:	5.3	←
2:	9.2	↓
3:	8.0	→
4:	8.3	↗
5:	8.4	↘
Serie	38.0	
Total	307.0	

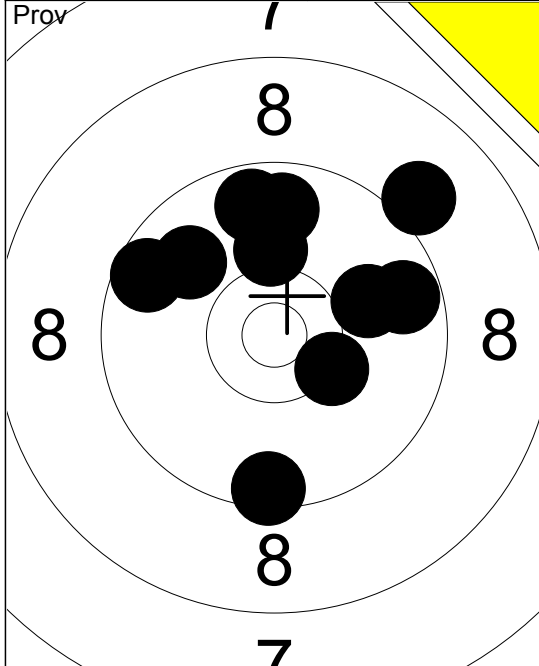

1:	10.0	→
2:	9.9	↖
3:	9.7	↑
4:	9.7	→
5:	9.1	↗
6:	10.1	↑
7:	9.6	↖
8:	9.5	↓
9:	*10.3	↘
10:	9.7	↑
Serie		93.0
Total		179.0

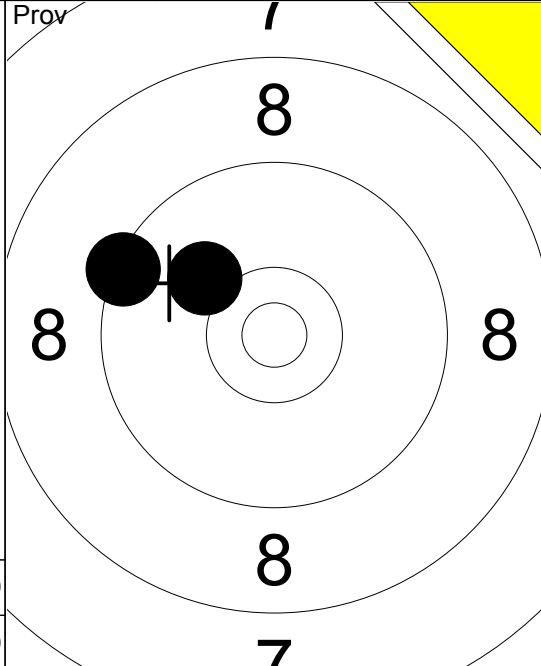

11:	9.4	↖
12:	10.1	↖
Serie		19.0
Total		179.0

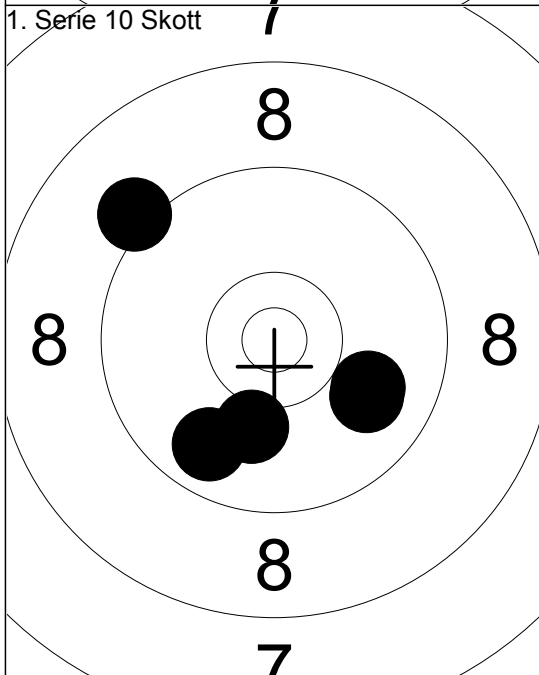

1:	9.2	↖
2:	9.8	↘
3:	10.1	↘
4:	9.9	↘
5:	9.9	↘
Serie		46.0
Total		225.0

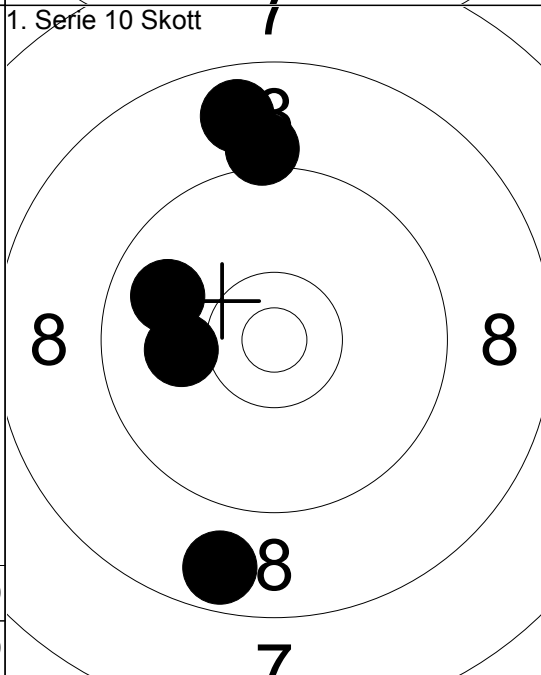

6:	8.7	↓
7:	9.9	↖
8:	8.8	↑
9:	10.1	↖
10:	9.1	↑
Serie		44.0
Total		269.0

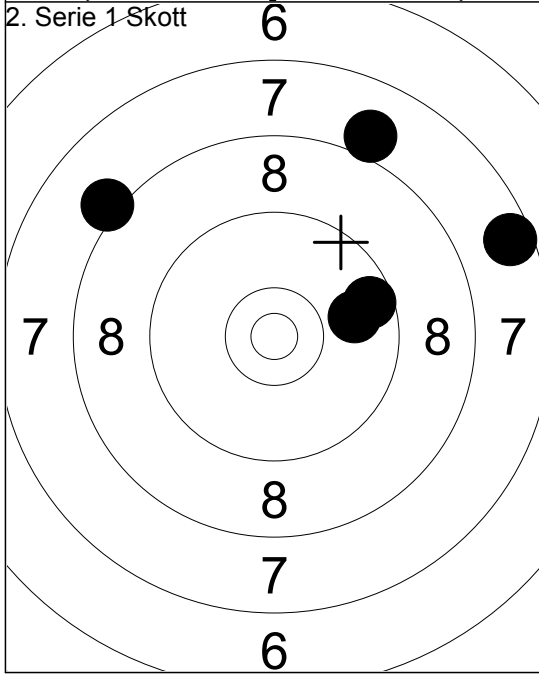

1:	9.6	→
2:	8.0	↗
3:	9.9	→
4:	8.1	↖
5:	7.6	→
Serie		41.0
Total		310.0

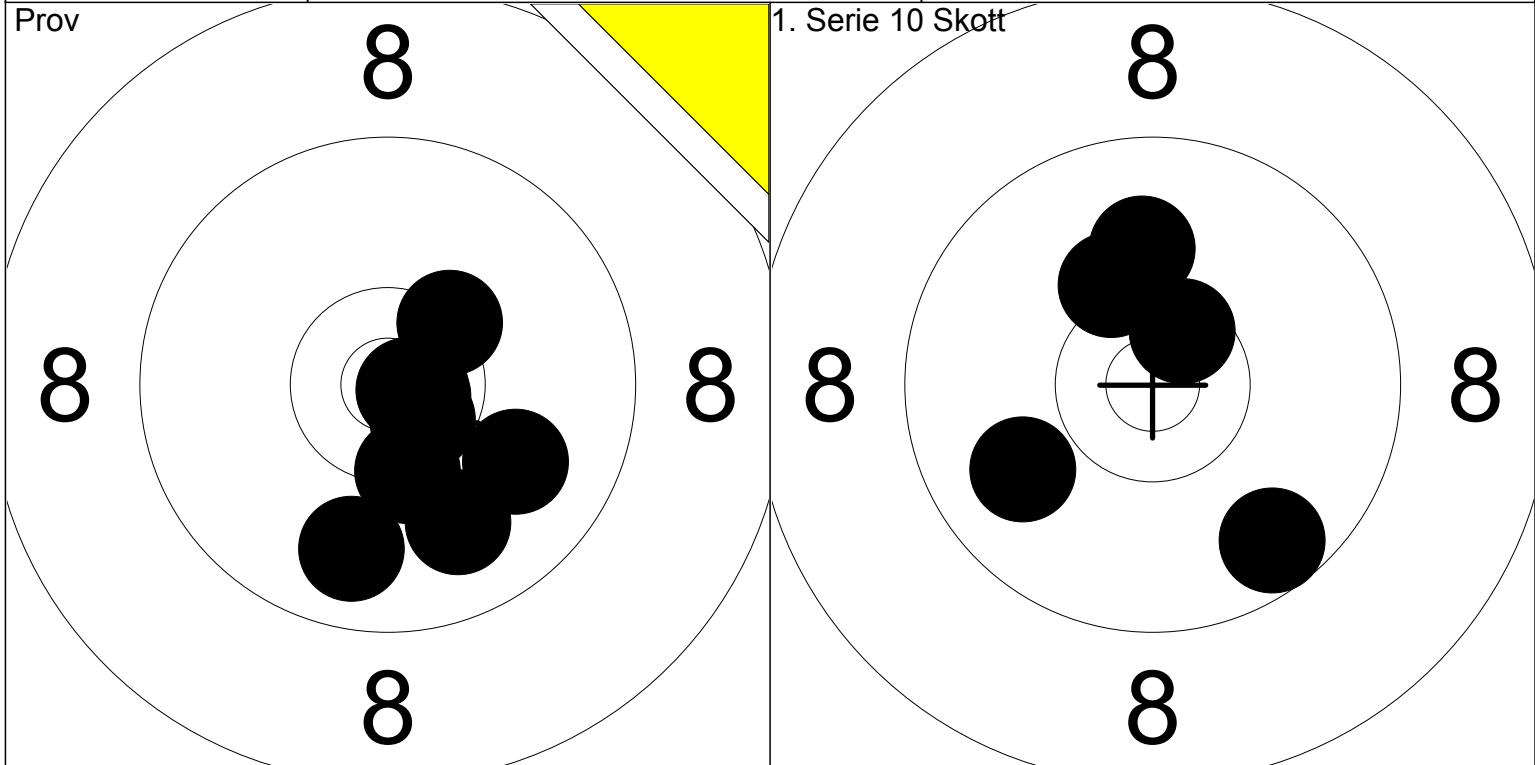

1: *10.7 →	6: *10.8 →		1: 9.9 ↙	
2: *10.6 ↘	7: 10.0 ↘	Serie 88.0	2: 10.0 ↑	Serie 48.0
3: 9.8 ↓	8: *10.8 →	Total 177.0	3: 10.2 ↗	Total 225.0
4: *10.4 ↓	9: 9.9 ↓		4: *10.5 ↗	
5: *10.4 ↗			5: 9.6 ↘	

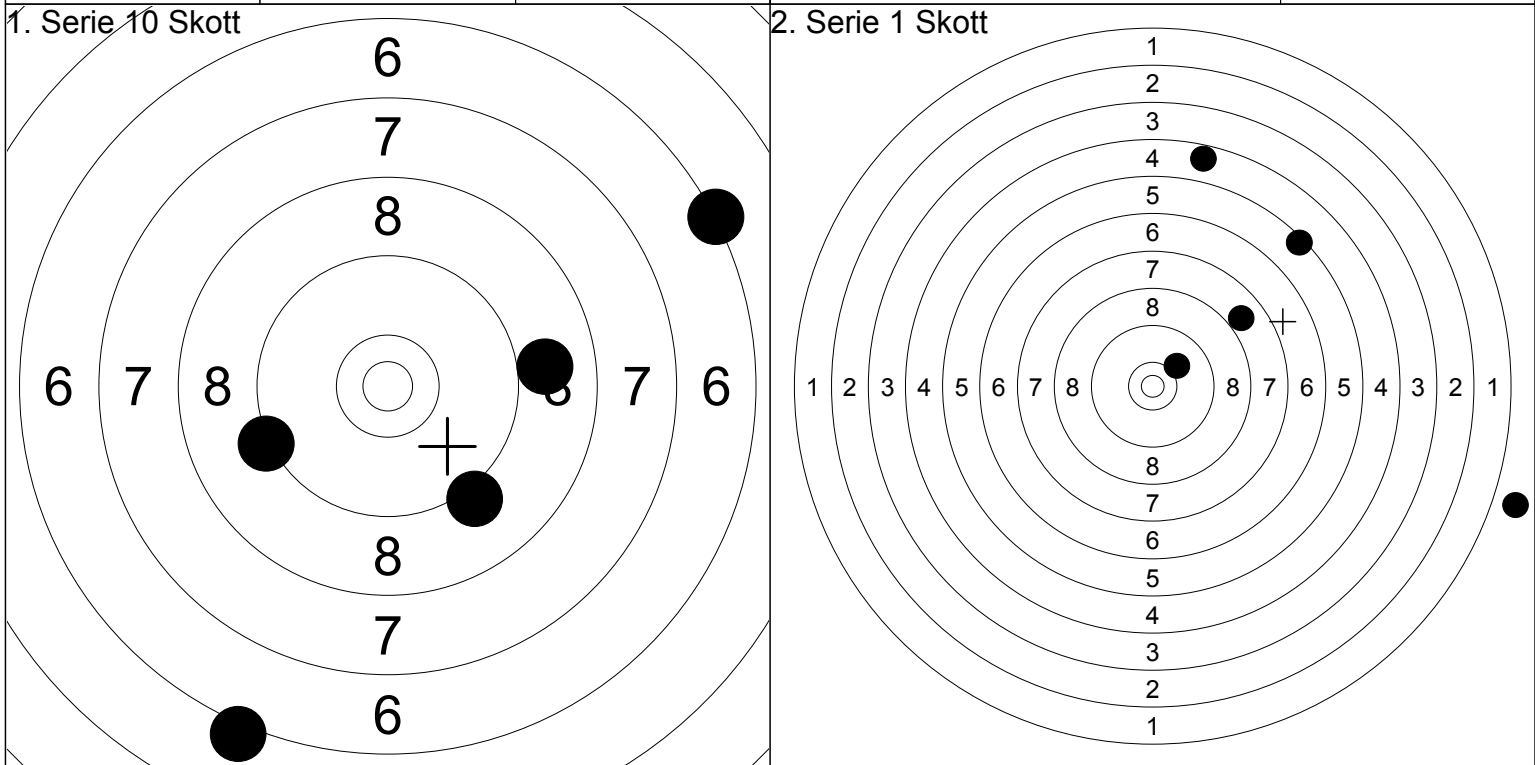

6: 9.3 ↙	7: 8.9 →		1: 4.7 ↑	
8: 9.1 ↘	9: 6.2 ↓	Serie 38.0	2: 10.1 ↗	Serie 26.0
10: 6.3 ↗		Total 263.0	3: 5.4 ↗	Total 289.0
			4: 0.0 →	

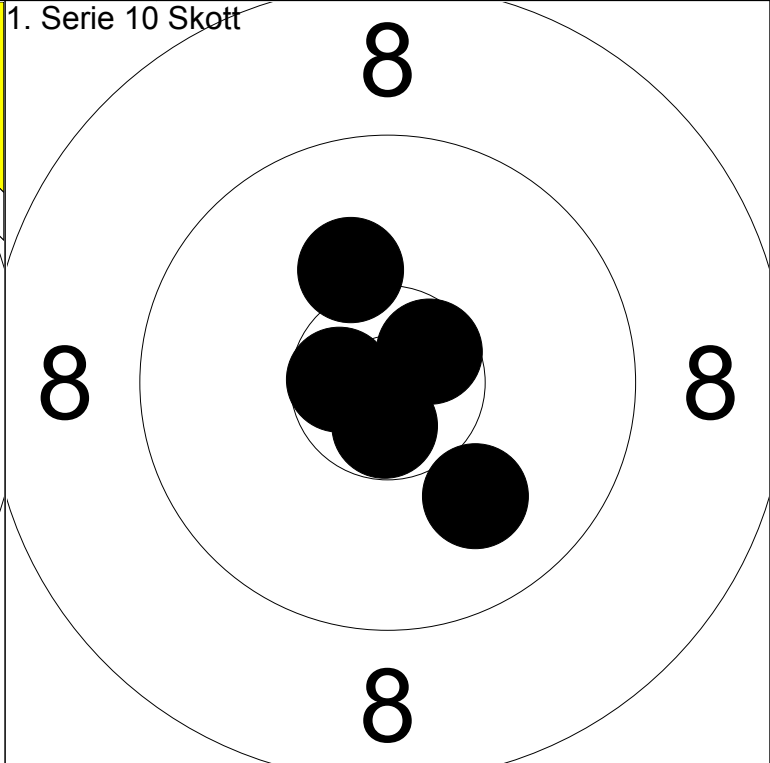
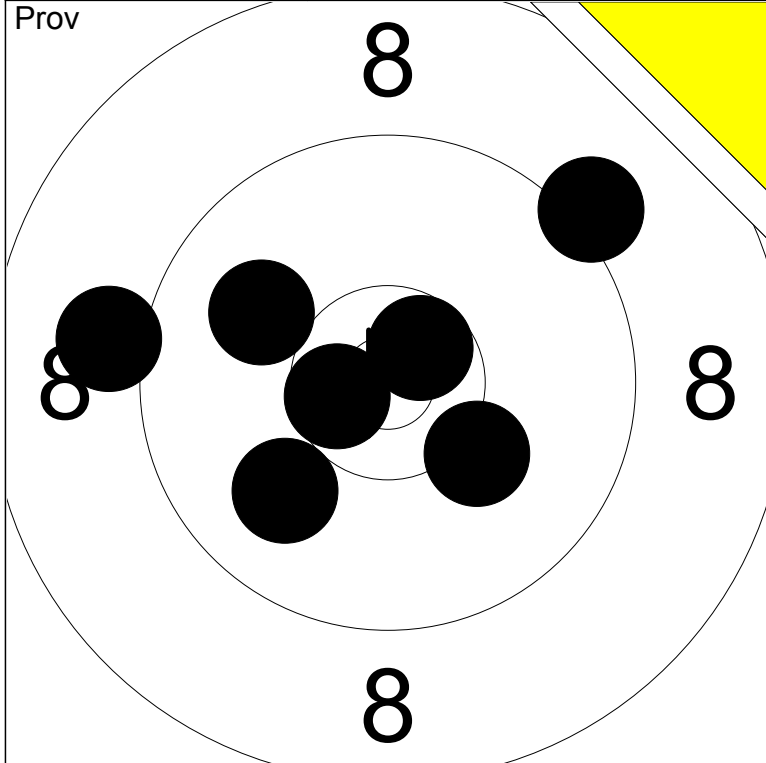

1: 9.1 ←	6: *10.6 ←	Serie	68.0
2: 10.0 ↙	7: *10.6 ↗		
3: 10.0 ↘		Total	175.0
4: 10.2 ↘			
5: 9.2 ↗			

1: 10.0 ↘	Serie	50.0
2: *10.7 ↓		
3: 10.2 ↑	Total	225.0
4: *10.6 ↗		
5: *10.6 ←		

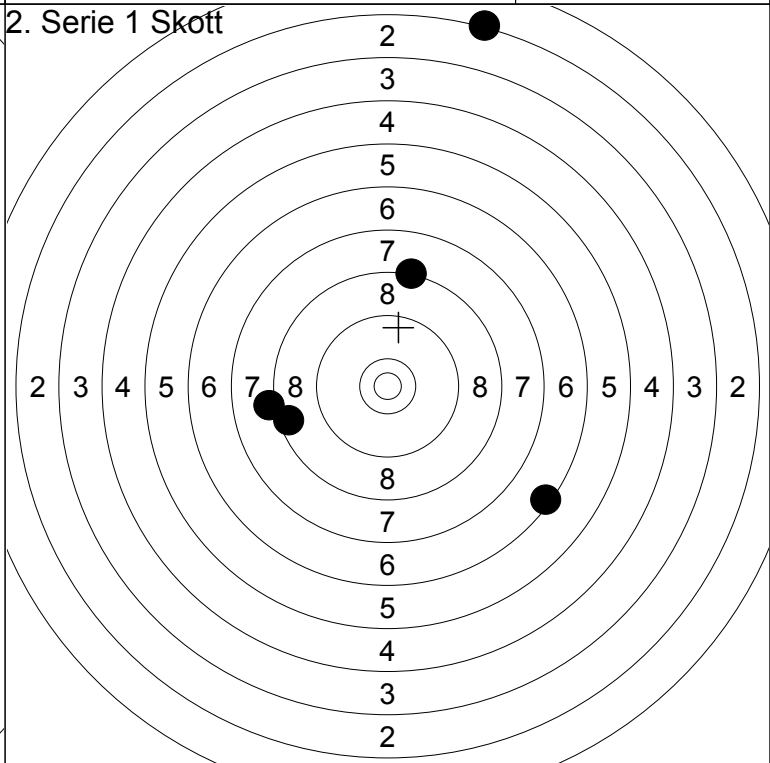
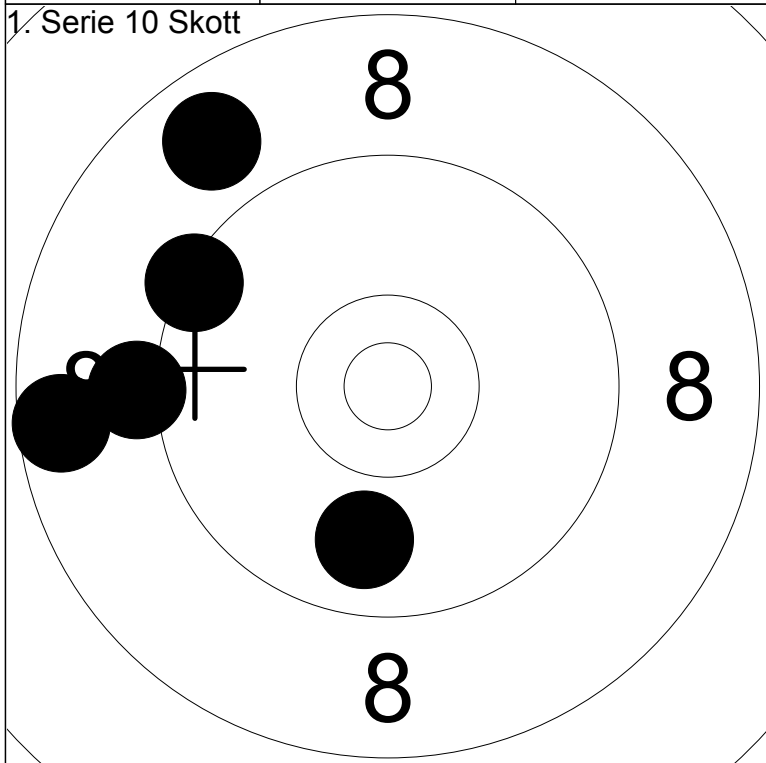

6: 9.2 ←	Serie	43.0
7: 8.6 ←		
8: 9.8 ↓	Total	268.0
9: 8.8 ↗		
10: 9.4 ↙		

1: 2.3 ↑	Serie	32.0
2: 6.4 ↘		
3: 8.5 ←	Total	300.0
4: 8.2 ←		
5: 8.3 ↑		

Skjutlag
8

Tavla
23

Lars-Göran Lundqvist

50m

Ununge

8, Vet-S

St

18.07.2015

Tavelträffen KH 2015

Ramselefors SKF

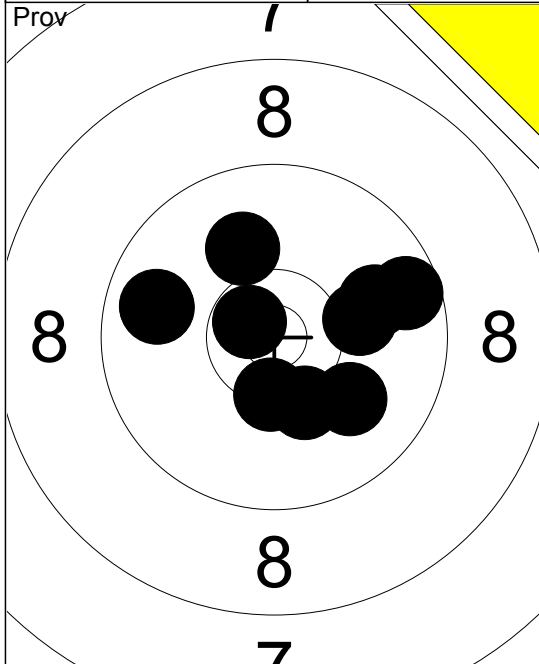

Prov

1:	9.8	←
2:	10.0	↘
3:	9.9	→
4:	10.3	↘
5:	*10.7	↗
6:	9.8	←
7:	10.1	→
8:	10.1	↗
9:	9.6	→
10:	*10.4	↓
Serie	96.0	
Total	174.0	

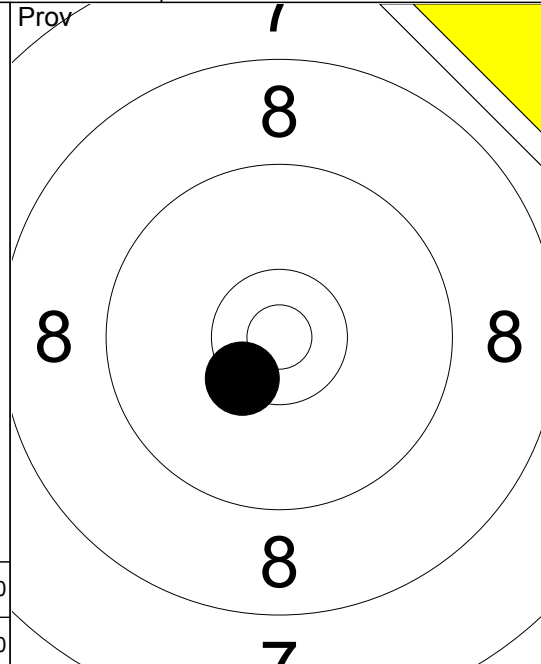

Prov

11:	*10.4	↘
Serie	10.0	
Total	174.0	

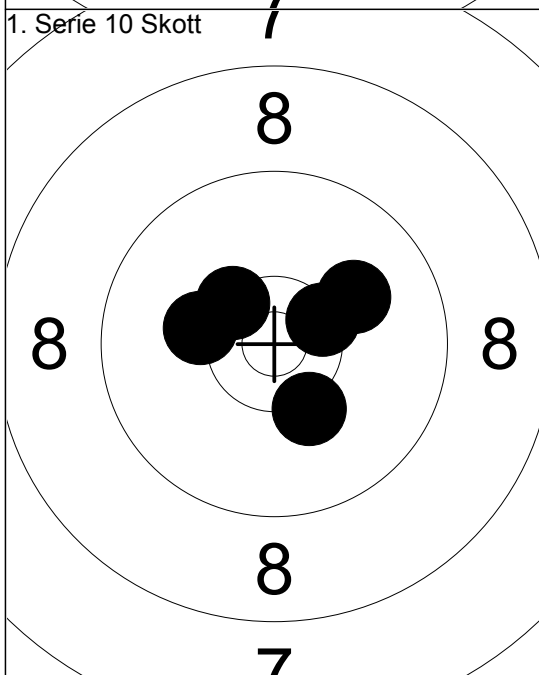

1. Serie 10 Skott

1:	10.2	←
2:	*10.4	↗
3:	10.2	↘
4:	10.1	↗
5:	*10.4	↗
Serie	50.0	
Total	224.0	

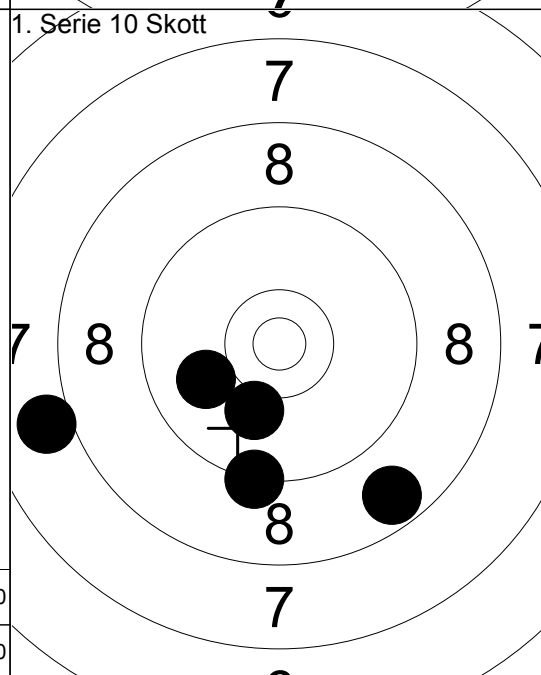

1. Serie 10 Skott

6:	9.3	↓
7:	8.0	←
8:	10.0	←
9:	10.1	↘
10:	8.7	↘
Serie	45.0	
Total	269.0	

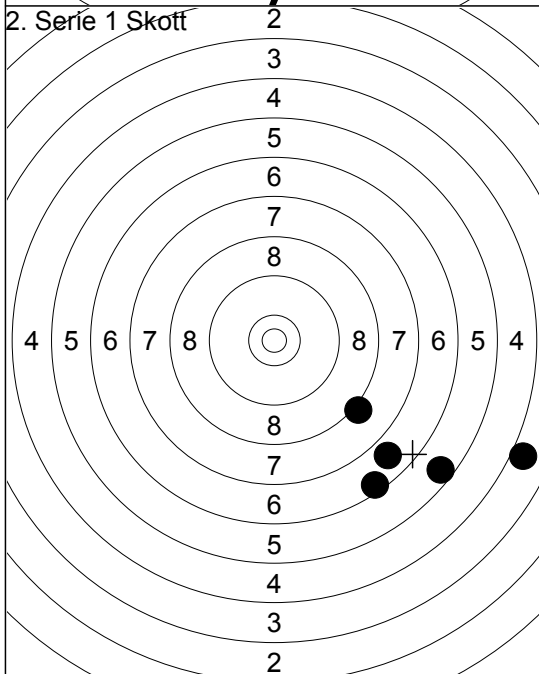

2. Serie 1 Skott

1:	4.0	↘
2:	6.5	↘
3:	8.2	↘
4:	6.9	↘
5:	5.6	↘
Serie	29.0	
Total	298.0	

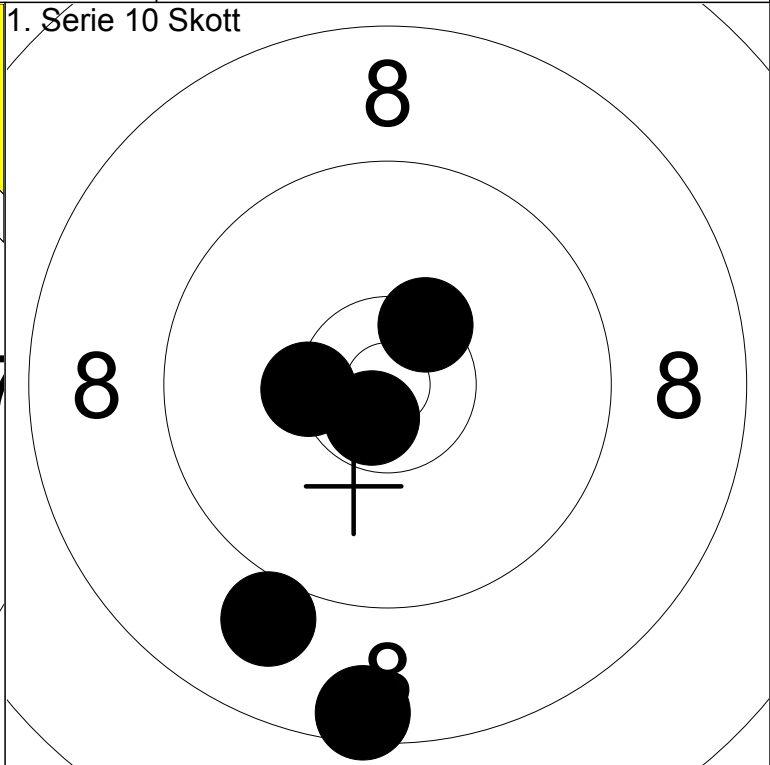
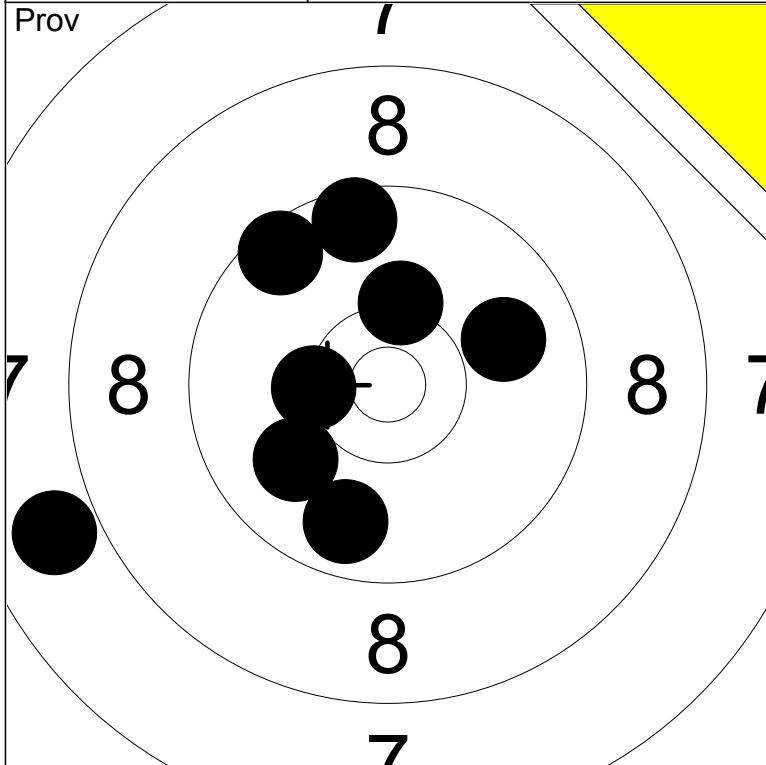

1: 9.8	↓	6: 7.9	←		
2: 9.9	→	7: *10.3	←	Serie	73.0
3: 9.6	↑	8: 10.3	↑		
4: 10.0	↙			Total	173.0
5: 9.5	↘				

1: *10.4	↗				
2: 9.0	↓	Serie		47.0	
3: *10.4	←				
4: *10.7	↓	Total		220.0	
5: 8.5	↓				

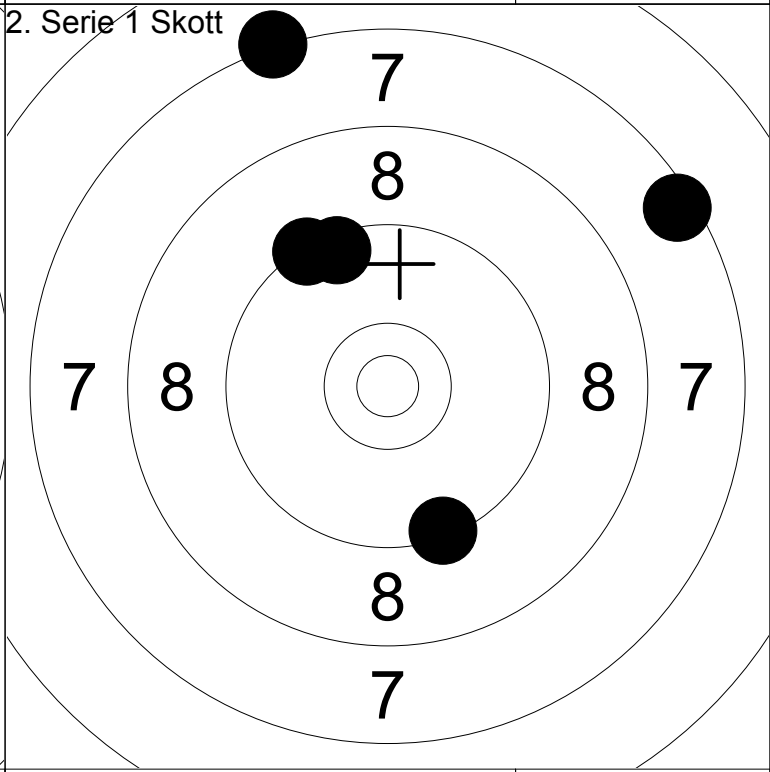
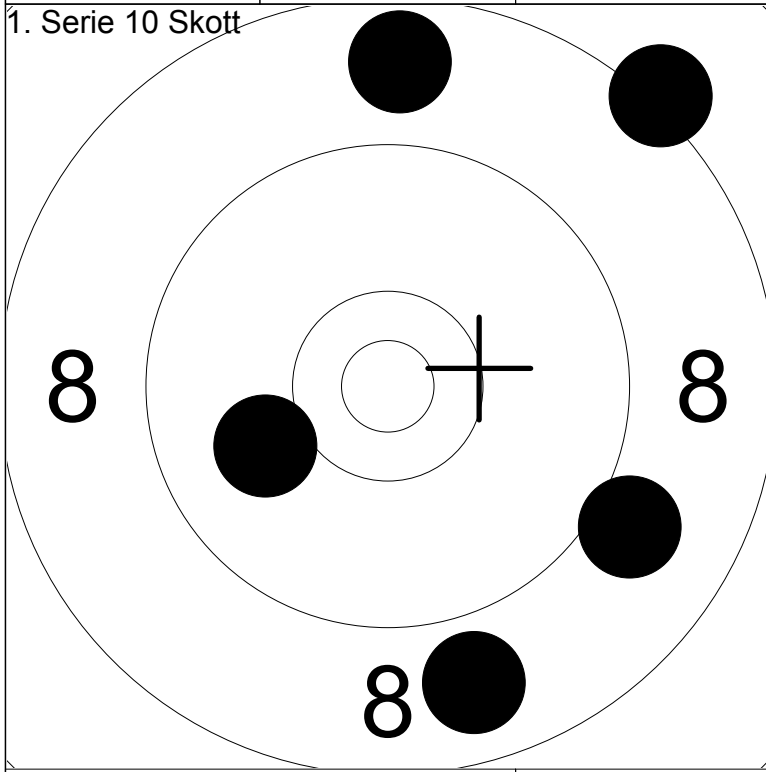

6: 8.8	↓				
7: 8.2	↗	Serie		43.0	
8: 10.0	←				
9: 8.7	↑	Total		263.0	
10: 9.0	↘				

1: 9.3	↗				
2: 9.5	↗	Serie		41.0	
3: 9.4	↙				
4: 7.3	↗	Total		304.0	
5: 7.5	↗				

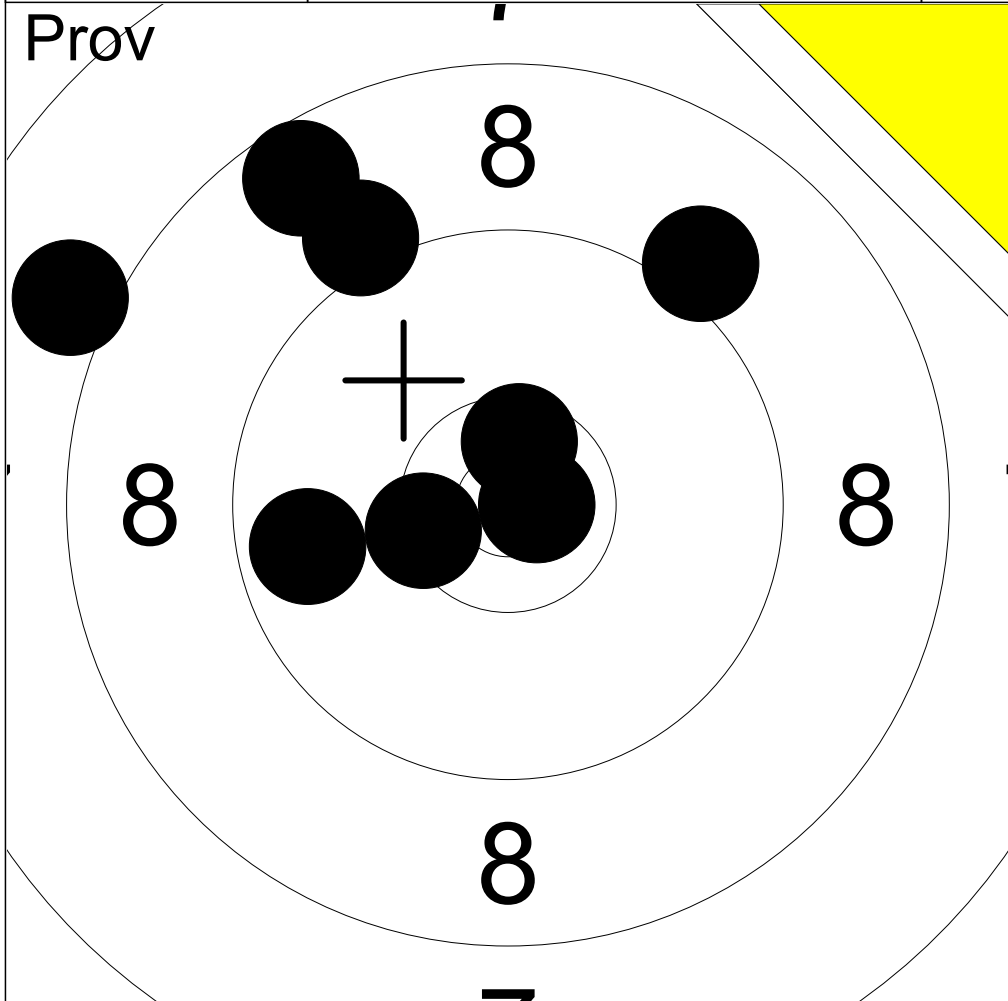

1:	*10.8	→
2:	8.0	↗
3:	9.1	↗
4:	8.6	↗
5:	9.1	↗
6:	*10.6	↗
7:	9.7	←
8:	*10.4	←

Serie	73.0
Total	287.0

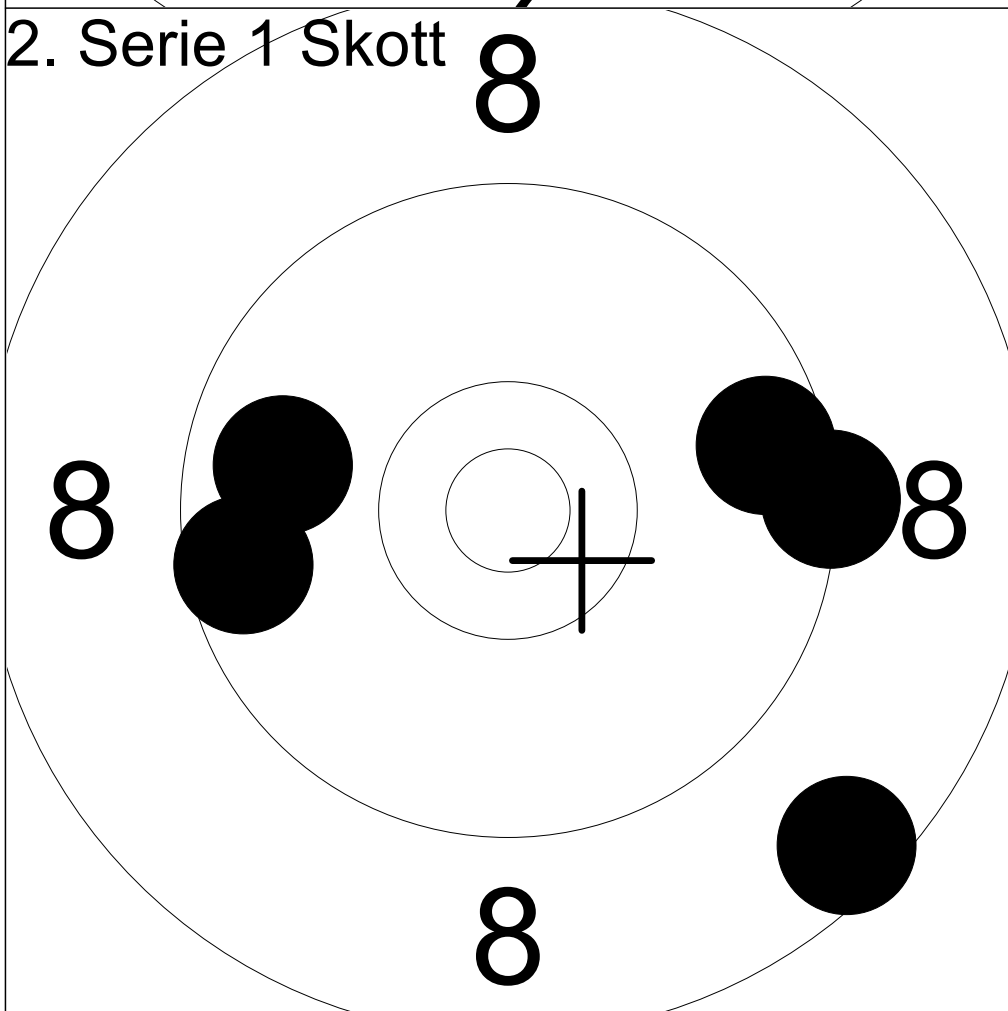

1:	9.3	→
2:	9.8	←
3:	9.6	↗
4:	8.6	↘
5:	9.6	←

Serie	44.0
Total	331.0

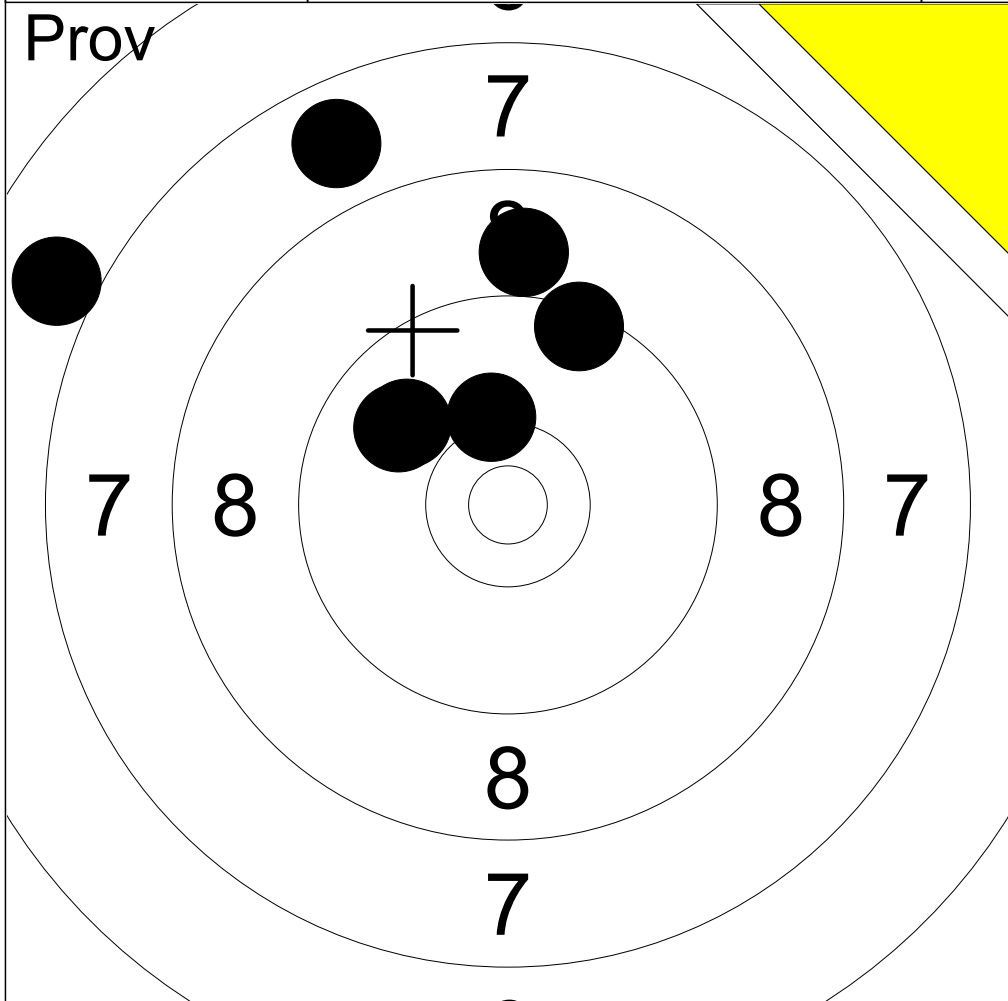

1:	9.0	↑
2:	7.0	↖
3:	10.2	↑
4:	7.8	↗
5:	9.9	↖
6:	9.9	↖
7:	9.4	↗

Serie	60.0
Total	284.0

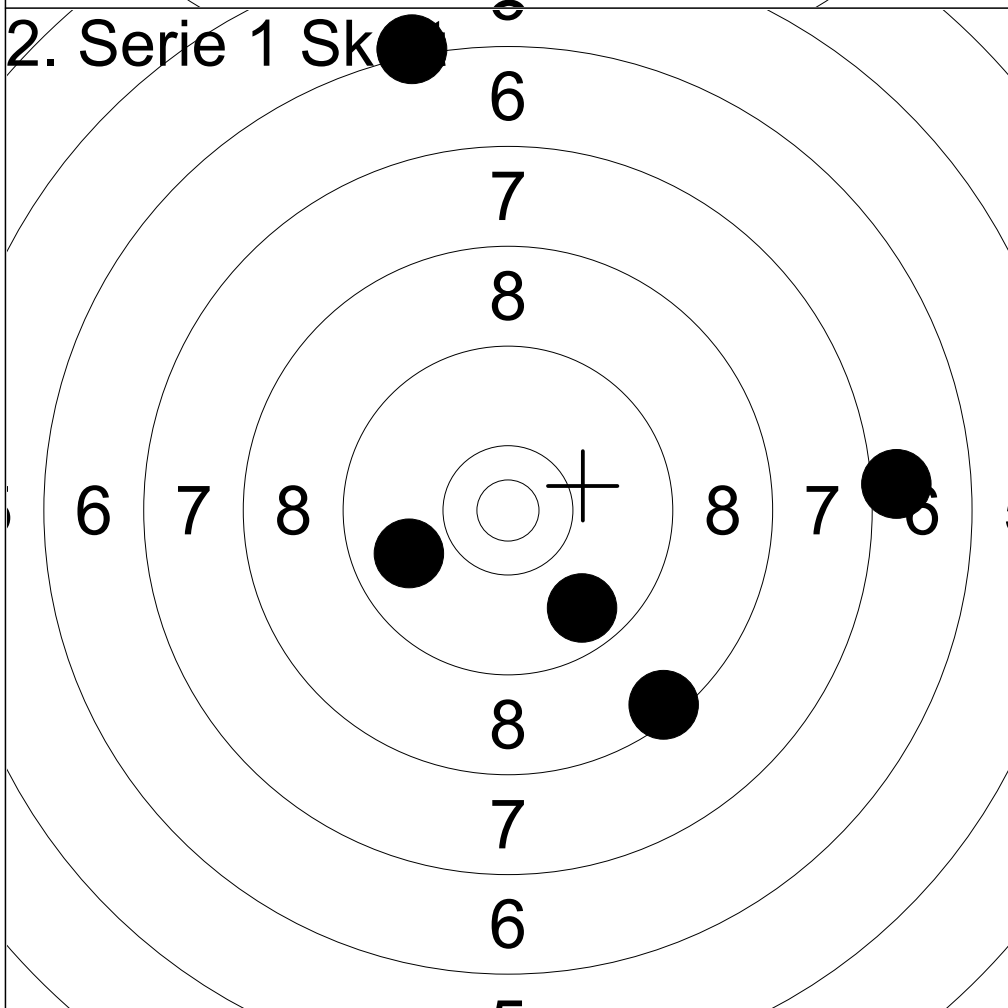

1:	9.7	↘
2:	6.2	↑
3:	9.9	↖
4:	7.0	→
5:	8.5	↘

Serie	39.0
Total	323.0

Prov

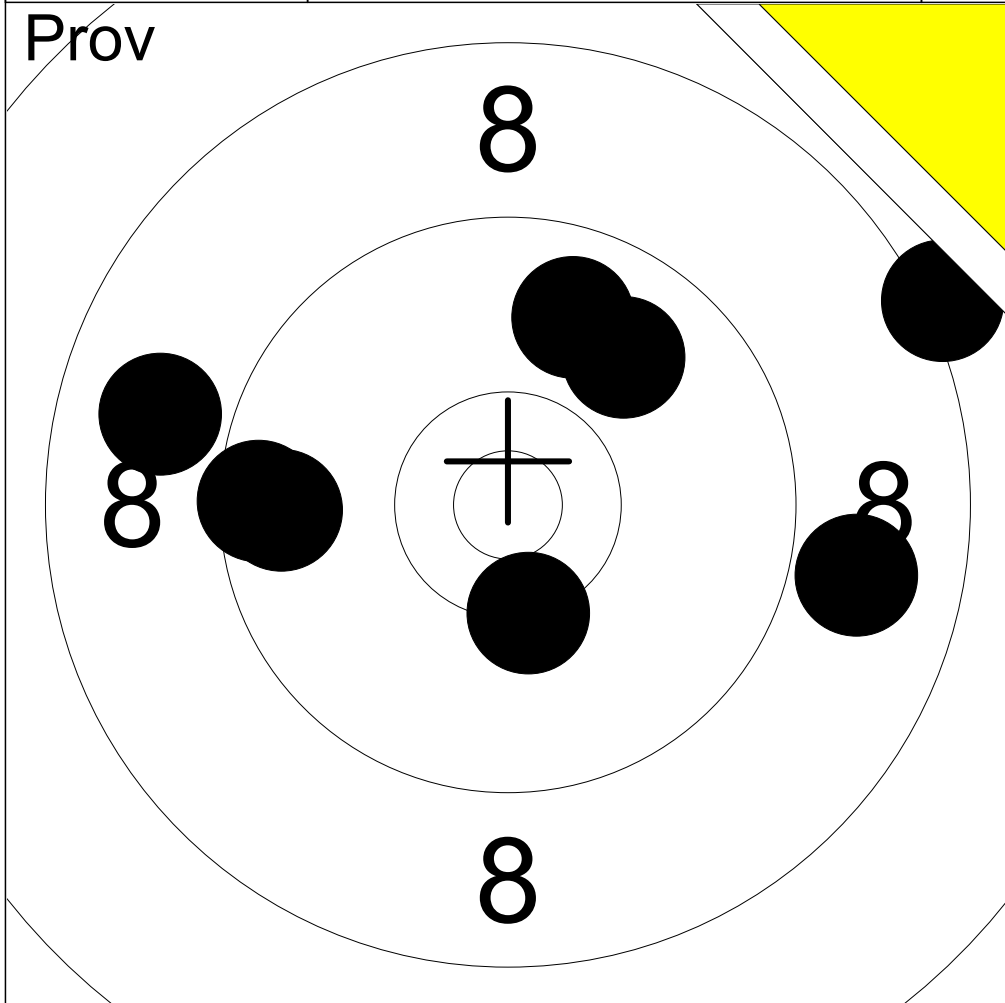

1:	8.9	→
2:	8.2	↗
3:	9.7	←
4:	9.5	←
5:	8.9	↖
6:	9.8	↗
7:	9.9	↗
8:	*10.3	↓

Serie	70.0
Total	284.0

2. Serie 1 Skott

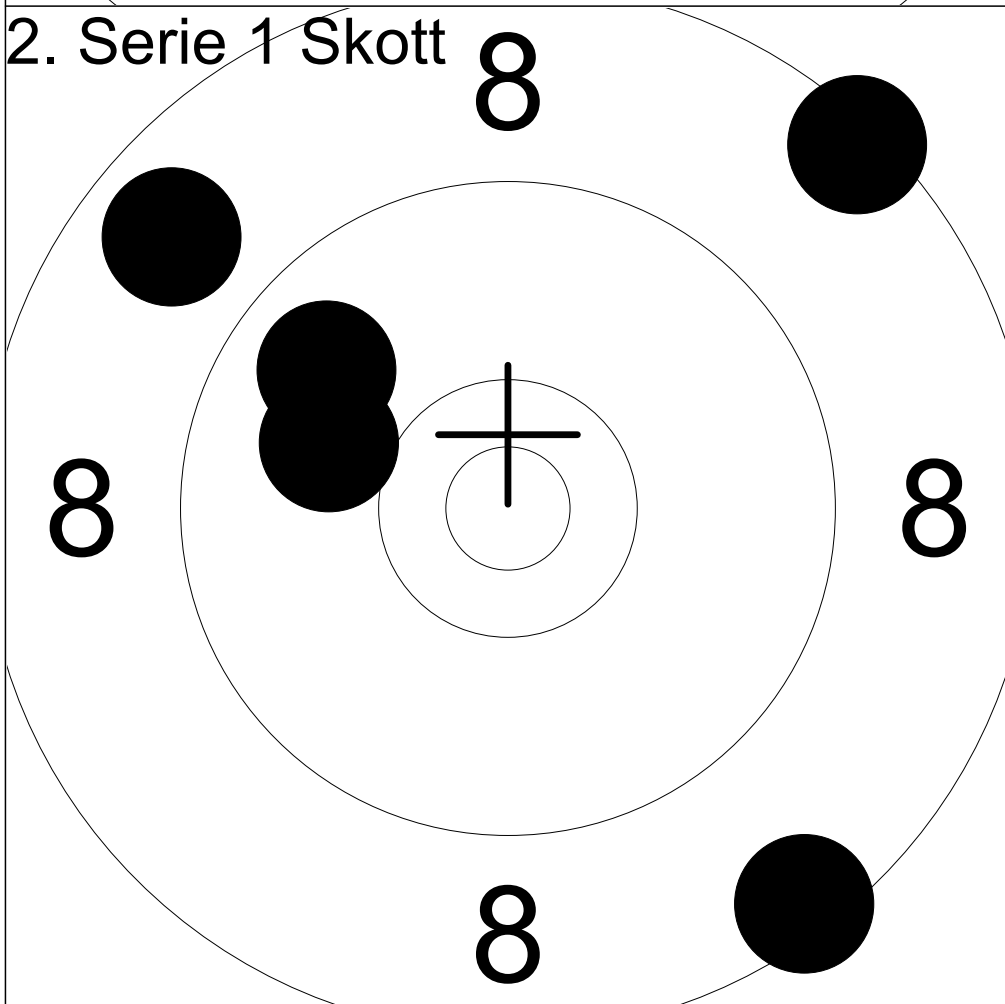

1:	9.8	↖
2:	8.4	↗
3:	10.0	←
4:	8.8	↗
5:	8.5	↘

Serie	43.0
Total	327.0

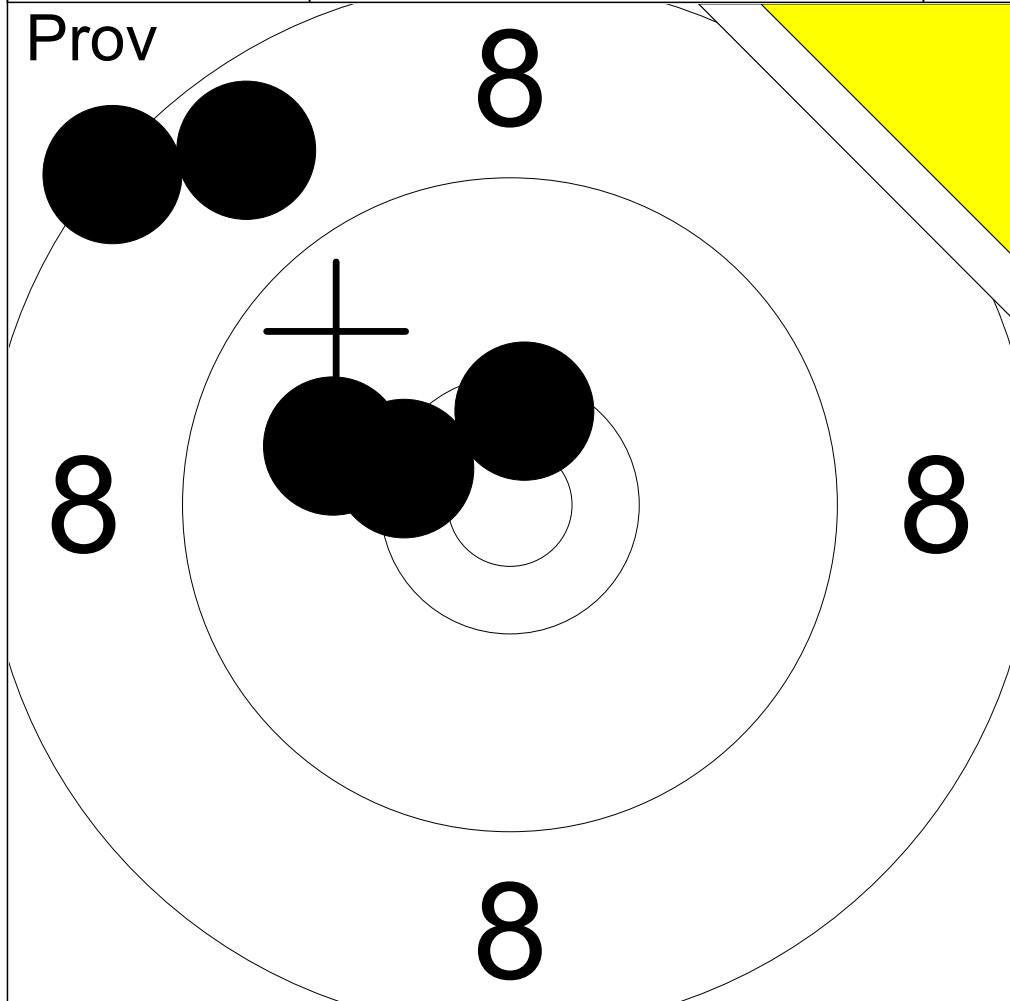

1:	8.3	↗
2:	10.0	↖
3:	*10.4	↖
4:	8.7	↖
5:	*10.5	↖

Serie	46.0
Total	279.0

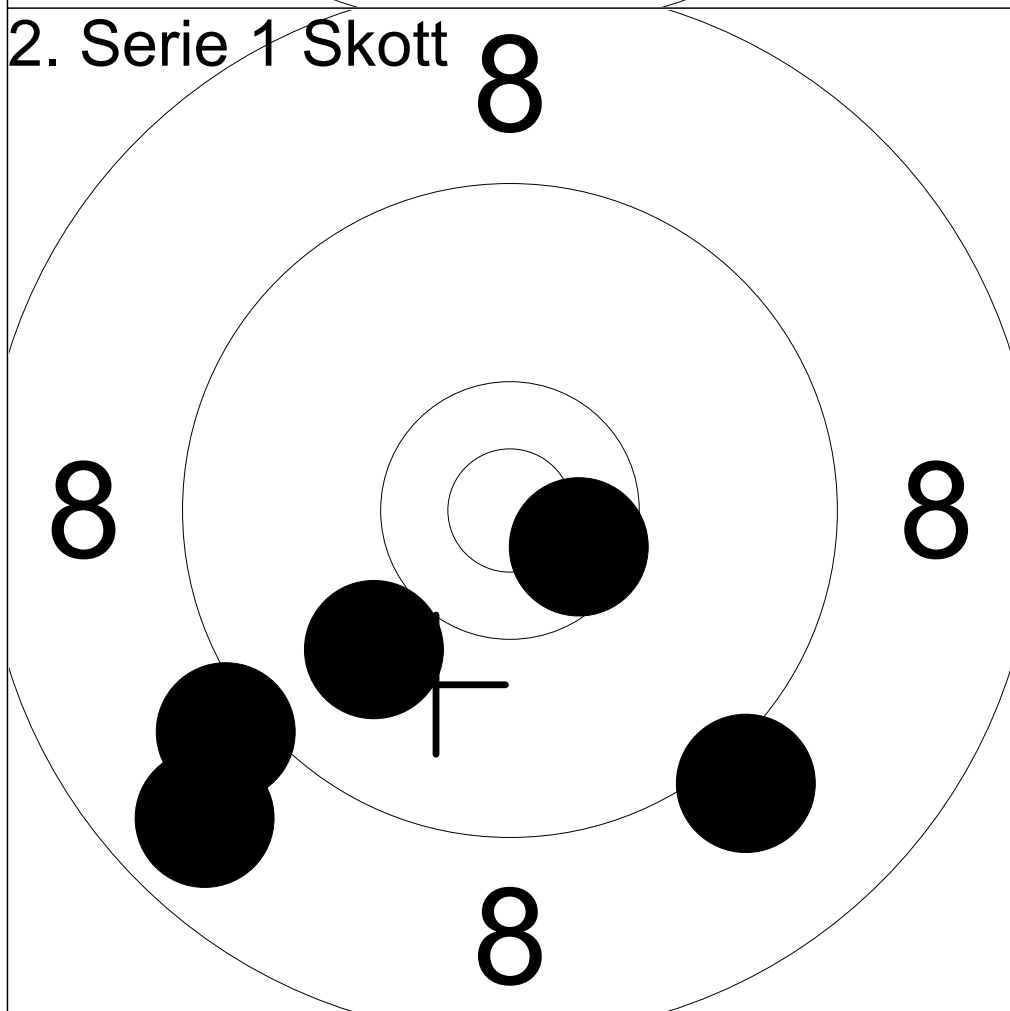

1:	9.1	↖
2:	8.8	↖
3:	*10.6	↖
4:	10.0	↖
5:	9.1	↖

Serie	46.0
Total	325.0

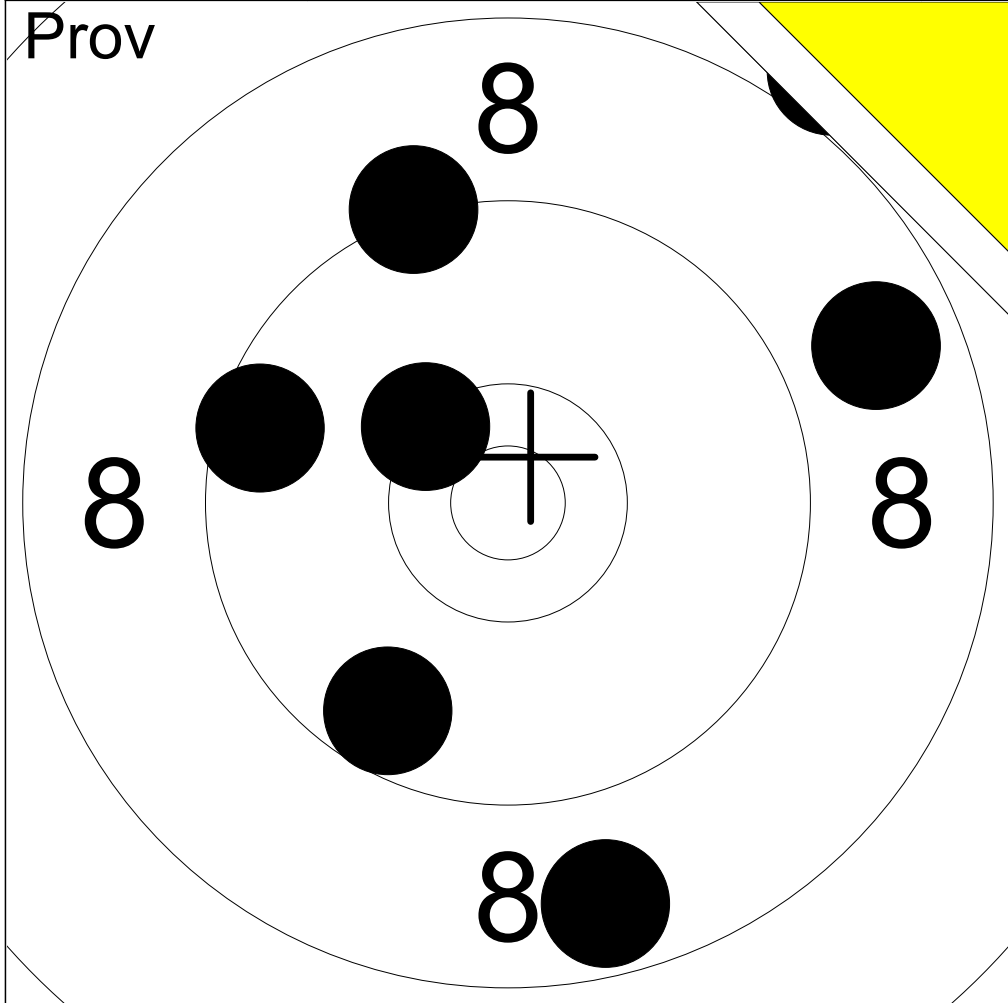

1:	8.7	↓
2:	9.5	↖
3:	9.3	↗
4:	*10.3	↗
5:	8.0	↗
6:	8.8	↗
7:	9.6	↙

Serie	61.0
-------	------

Total	283.0
-------	-------

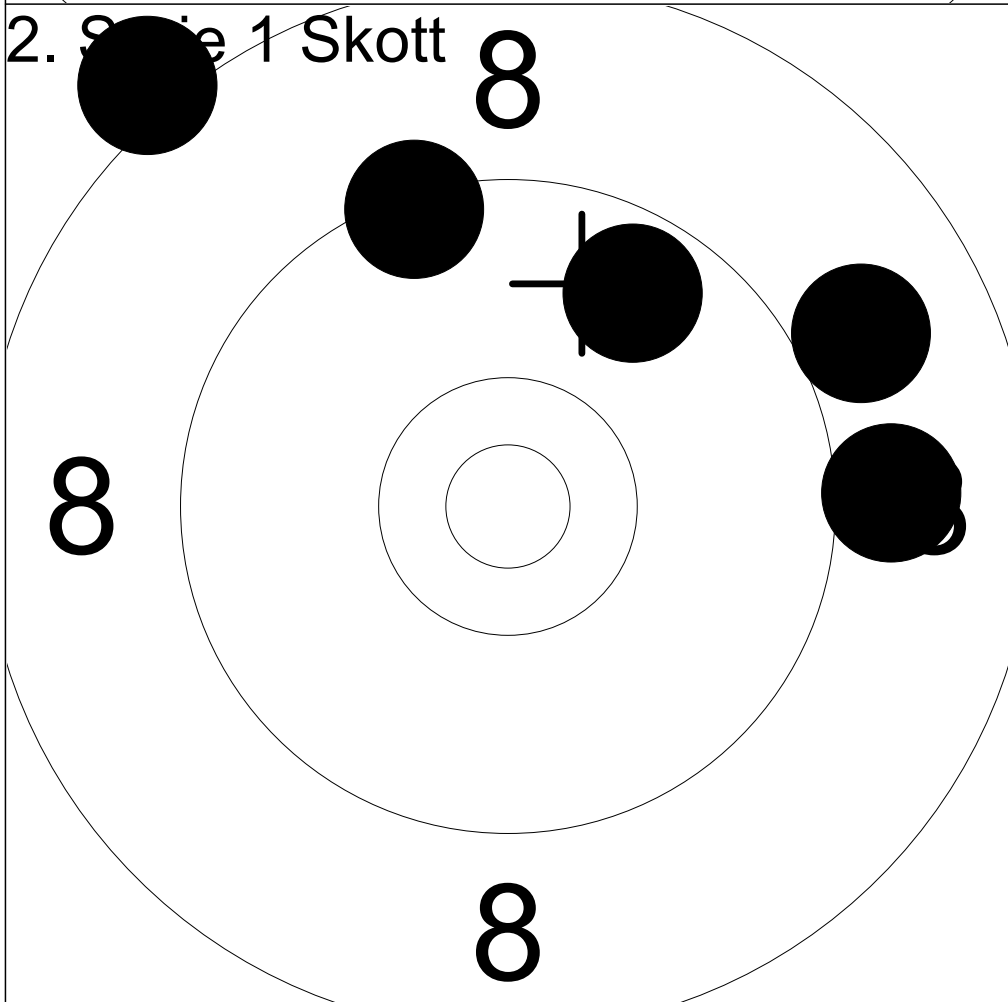

1:	8.2	↖
2:	9.0	↗
3:	9.0	→
4:	9.7	↗
5:	9.4	↗

Serie	44.0
-------	------

Total	327.0
-------	-------

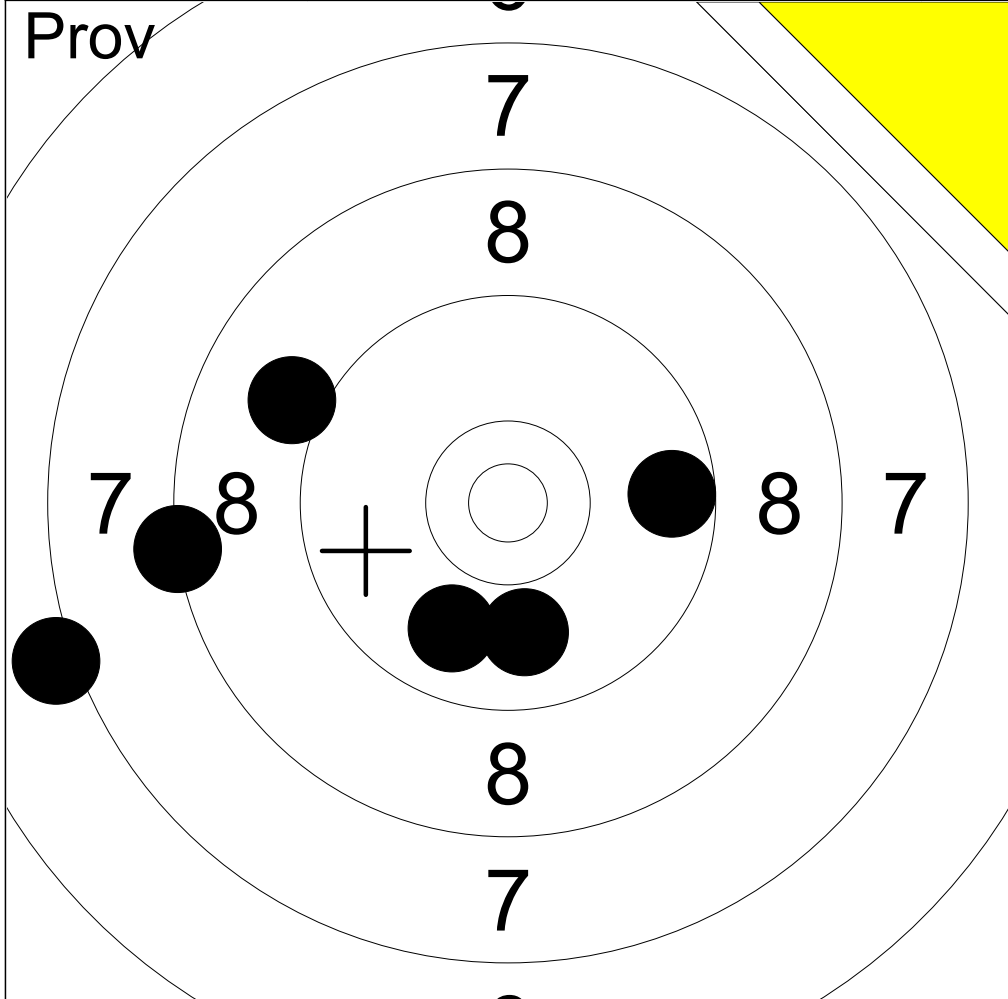

1:	8.3	←
2:	9.1	↖
3:	9.9	↓
4:	7.2	←
5:	9.9	↙
6:	9.7	→

Serie	51.0
Total	280.0

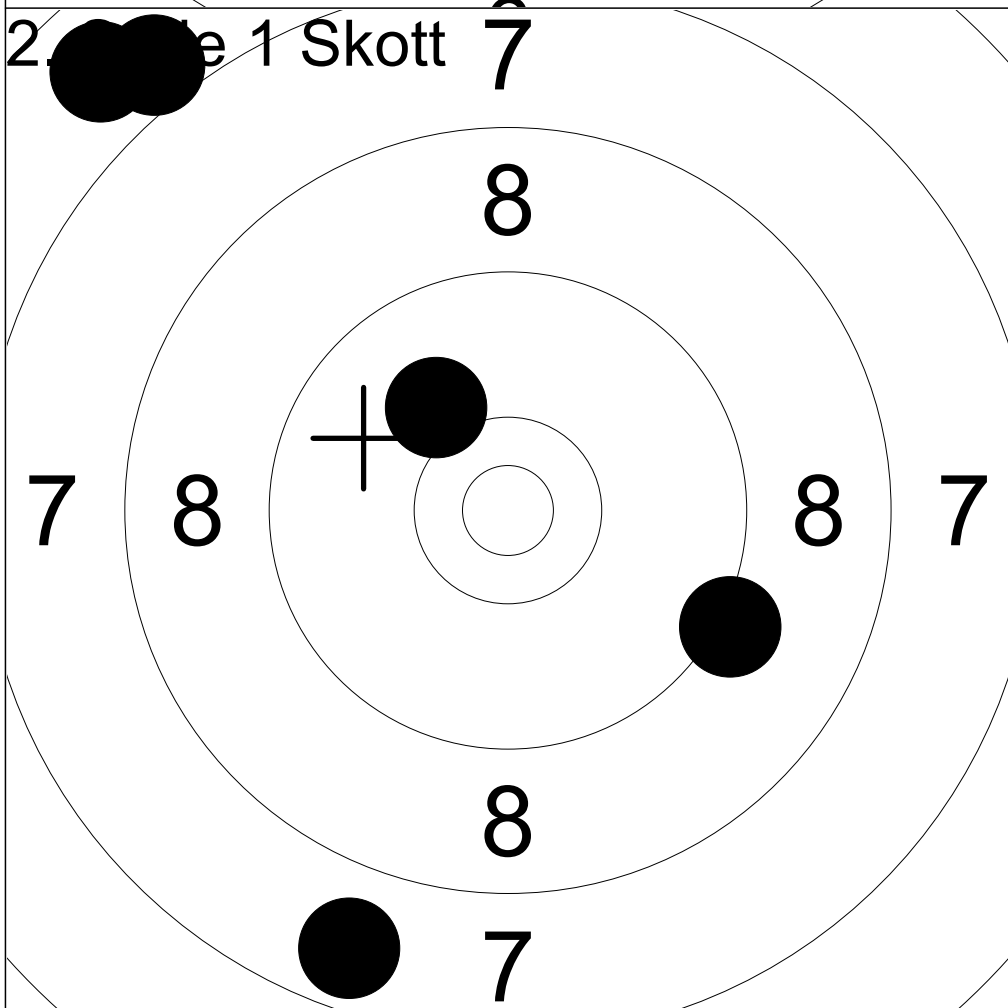

1:	7.0	↗
2:	7.7	↙
3:	10.1	↗
4:	6.8	↗
5:	9.2	↙

Serie	39.0
Total	319.0

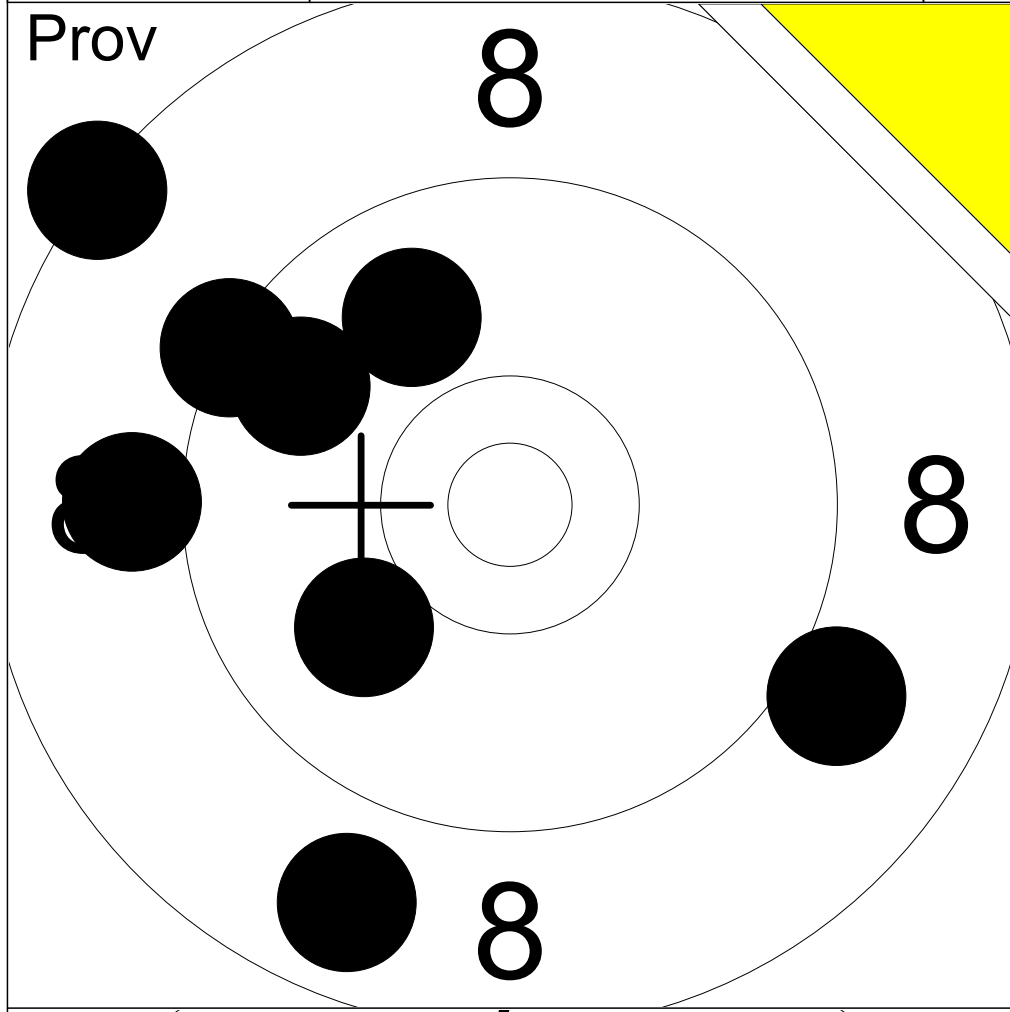

1:	9.3	↗
2:	8.3	↗
3:	10.0	↙
4:	8.8	↙
5:	9.0	↘
6:	9.0	↖
7:	9.9	↗
8:	9.7	↗

Serie	71.0
Total	281.0

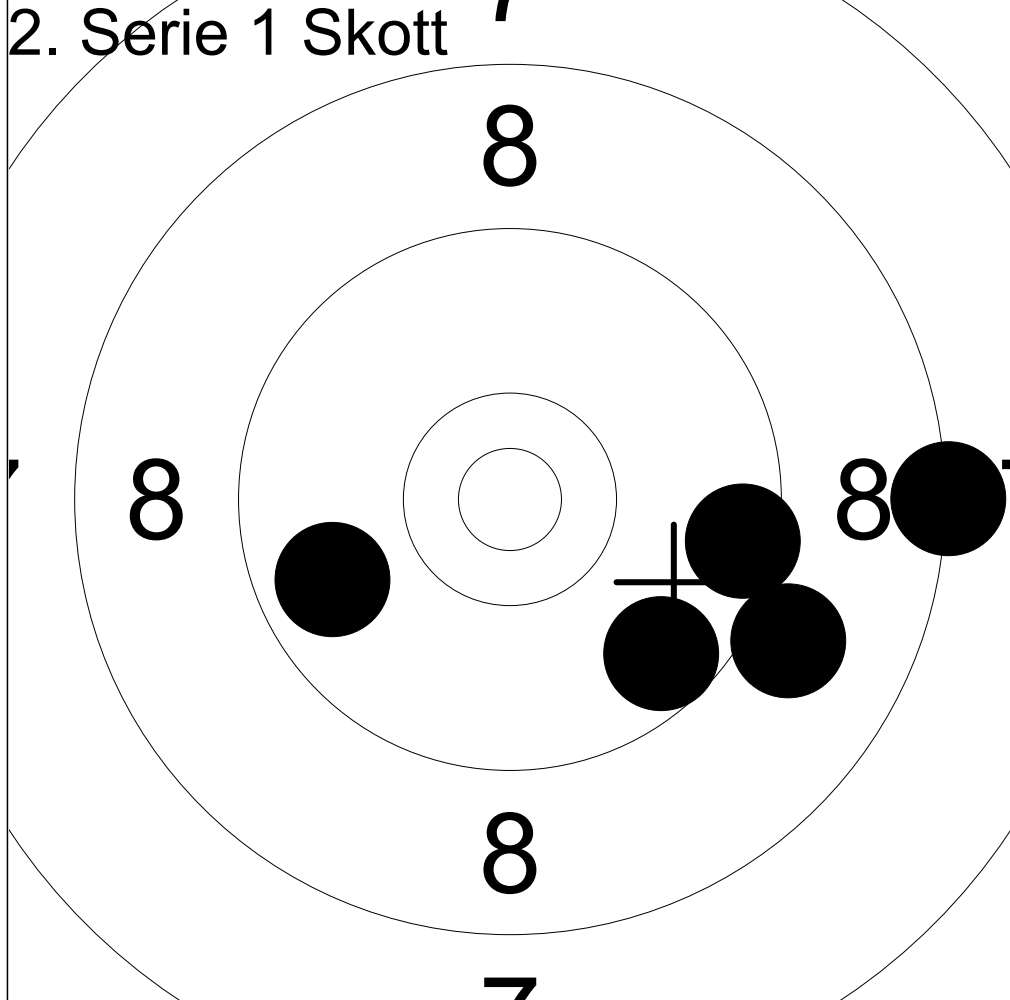

1:	9.1	↘
2:	9.6	↘
3:	9.5	→
4:	9.8	↖
5:	8.3	→

Serie	44.0
Total	325.0

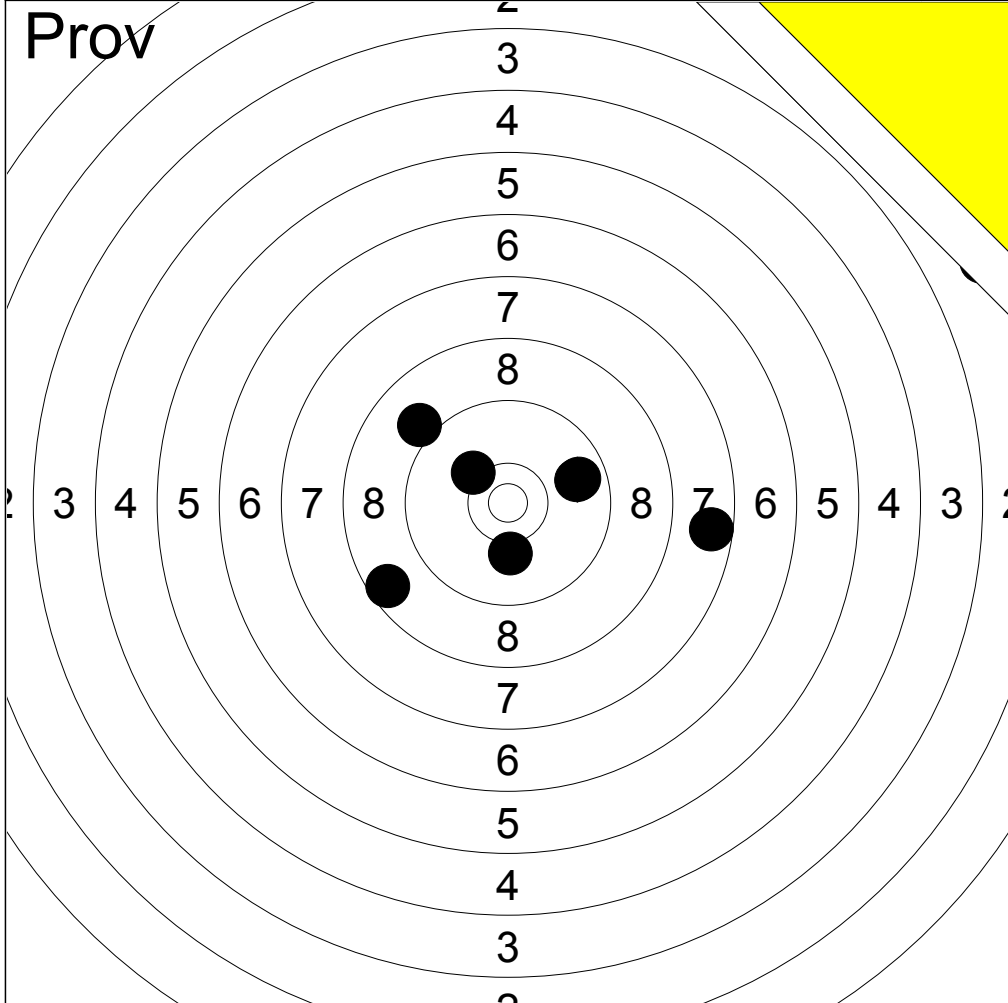

1:	10.2	↖
2:	9.8	↗
3:	9.7	↗
4:	10.1	↓
5:	2.4	↗
6:	8.6	↙
7:	7.6	↗
8:	9.0	↖

Serie	64.0
Total	279.0

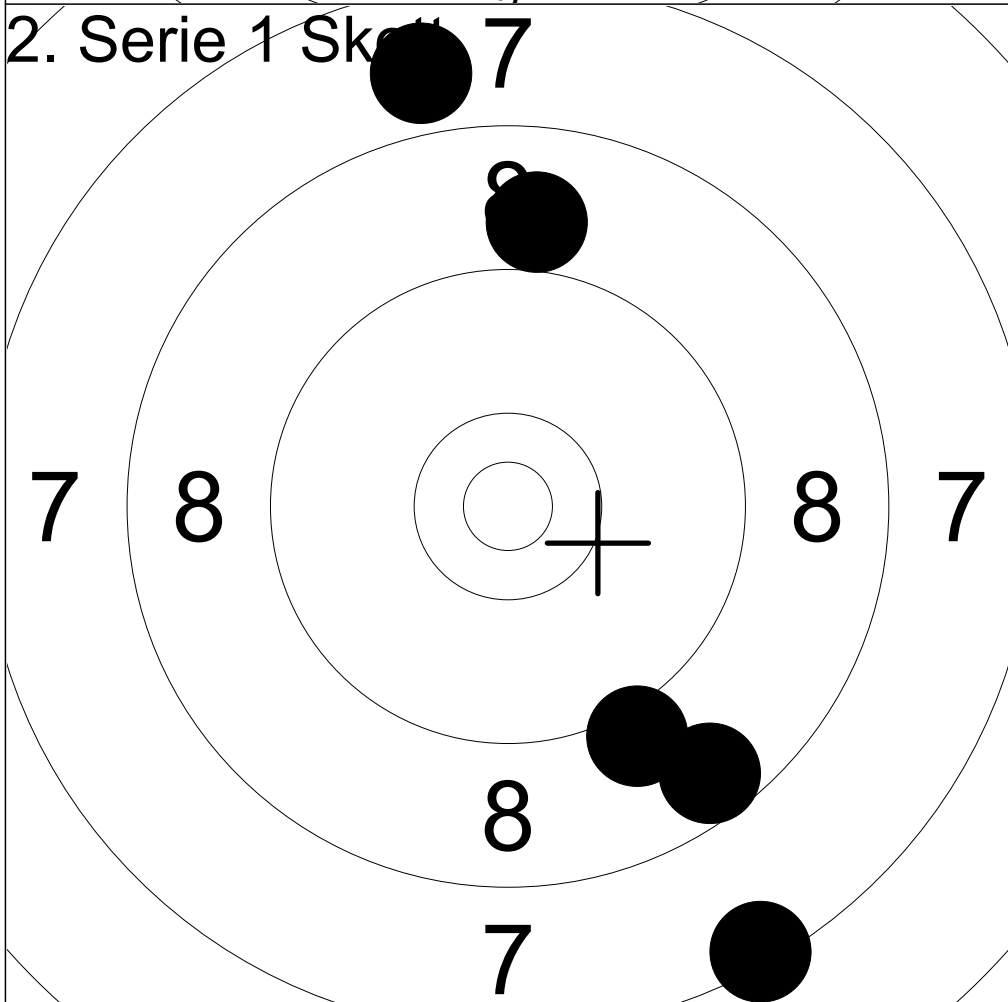

1:	7.9	↑
2:	7.4	↘
3:	9.1	↘
4:	8.6	↘
5:	9.0	↑

Serie	40.0
Total	319.0

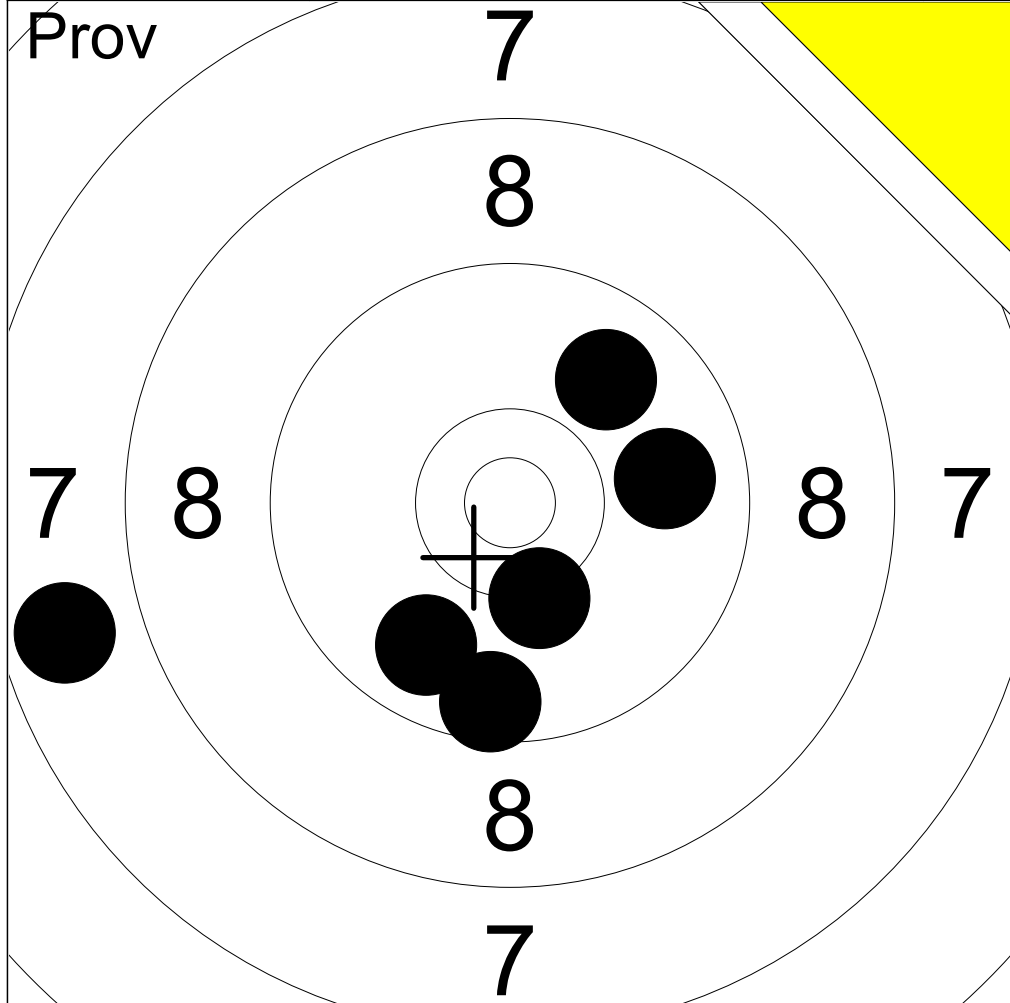

1:	9.8	↙
2:	9.9	↗
3:	10.3	↘
4:	9.9	→
5:	7.8	←
6:	9.6	↘
Serie		53.0
Total		271.0

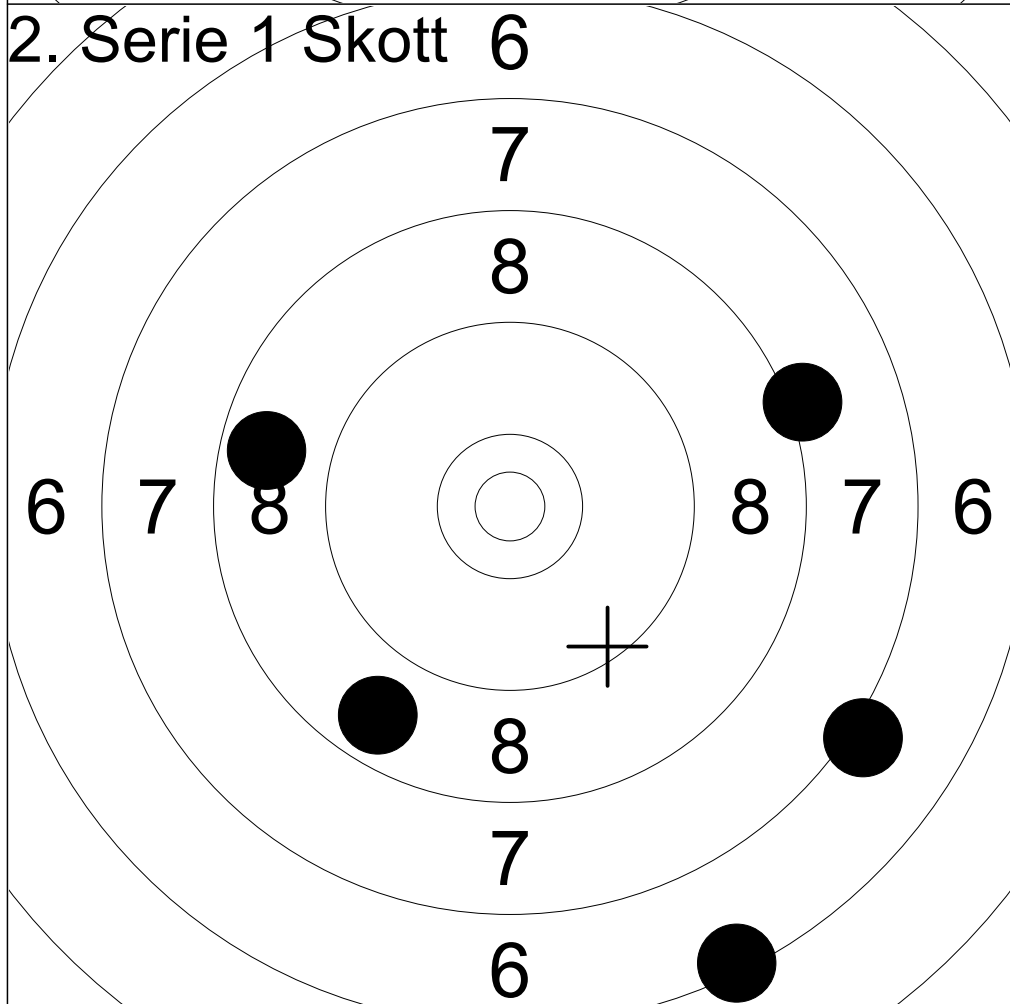

1:	6.4	↘
2:	8.2	↗
3:	8.7	↘
4:	7.2	↘
5:	8.7	←
Serie		37.0
Total		308.0

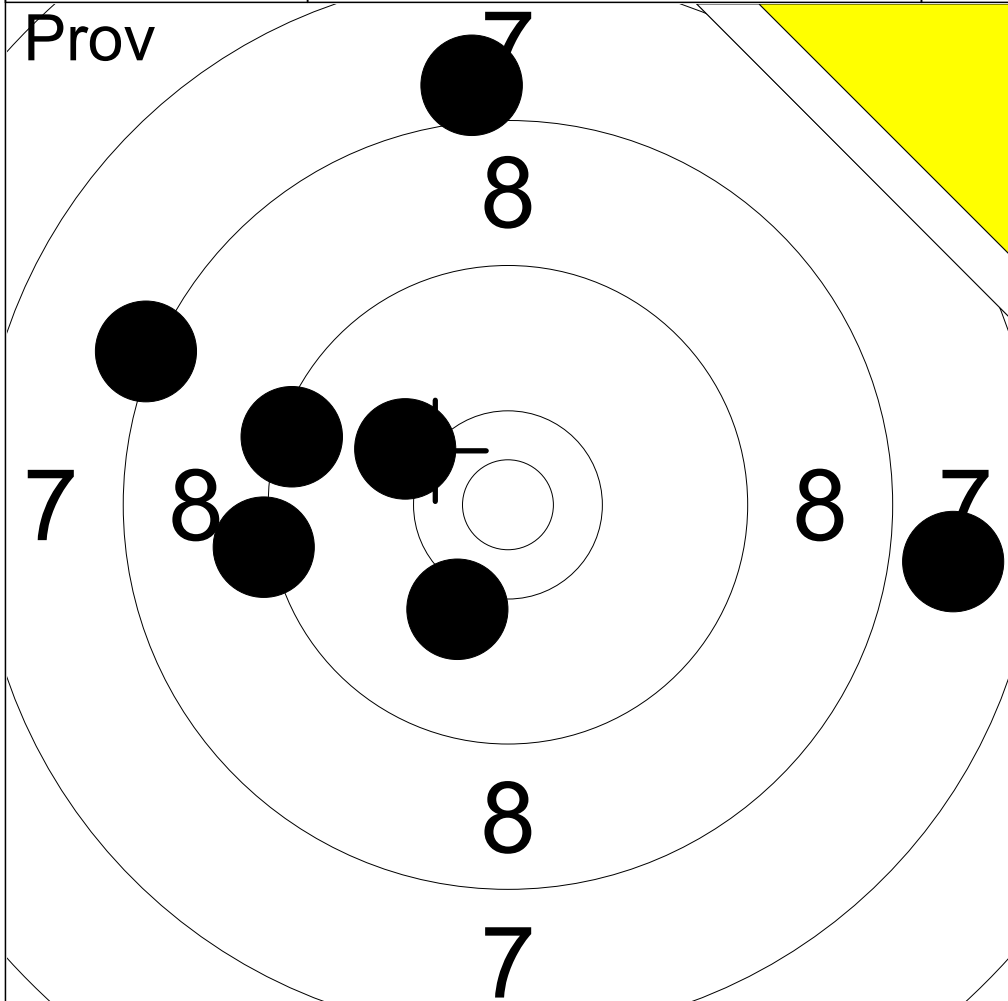

1:	8.2	↖
2:	10.2	↙
3:	7.9	→
4:	9.2	↖
5:	9.4	↗
6:	8.1	↑
7:	10.1	↖

Serie	61.0
Total	277.0

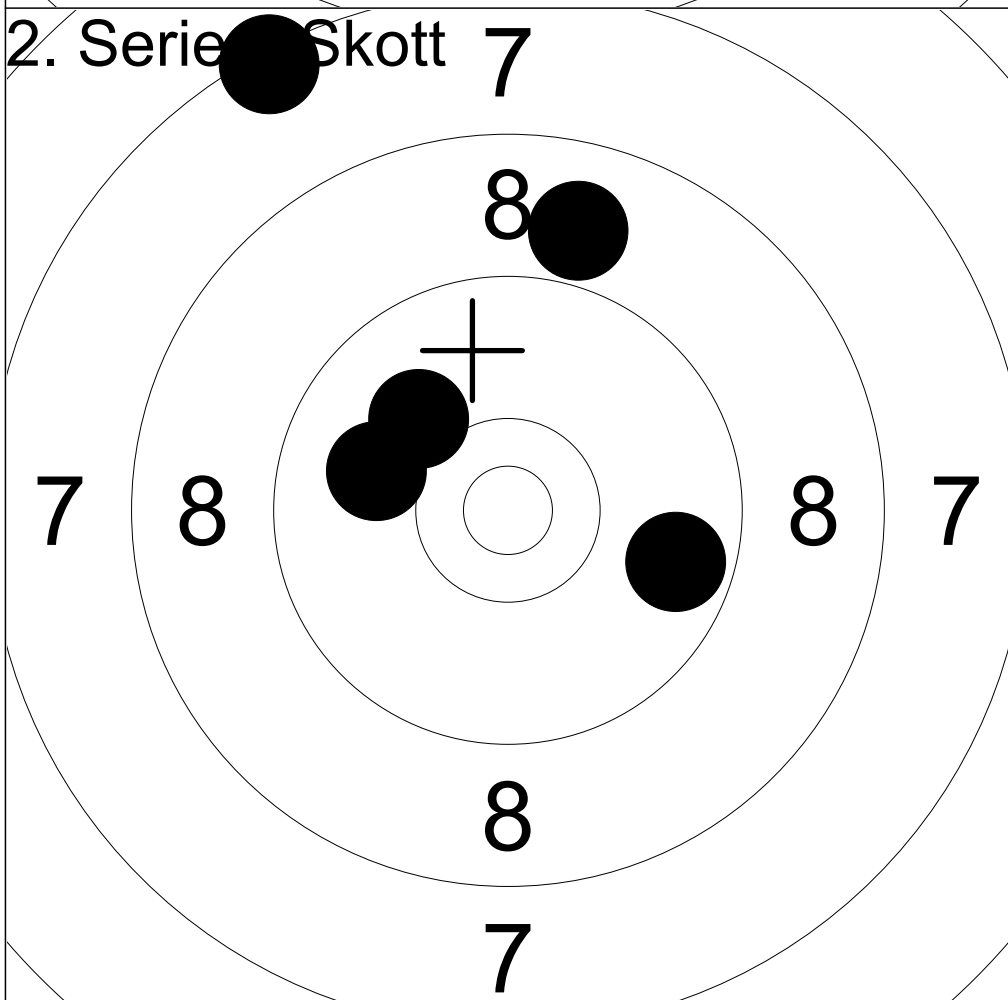

1:	9.7	→
2:	8.9	↑
3:	10.1	↗
4:	10.0	↖
5:	7.4	↗

Serie	44.0
Total	321.0