

1: 10.2 ↗	Series	28.0
2: 8.9 →		
3: 10.4 ↘		
Total		287.0

1: 9.8 →	Series	47.0
2: 9.6 ↗		
3: 9.5 ↖		
4: 10.3 ↖		
5: *10.7 ↗		
Total		334.0

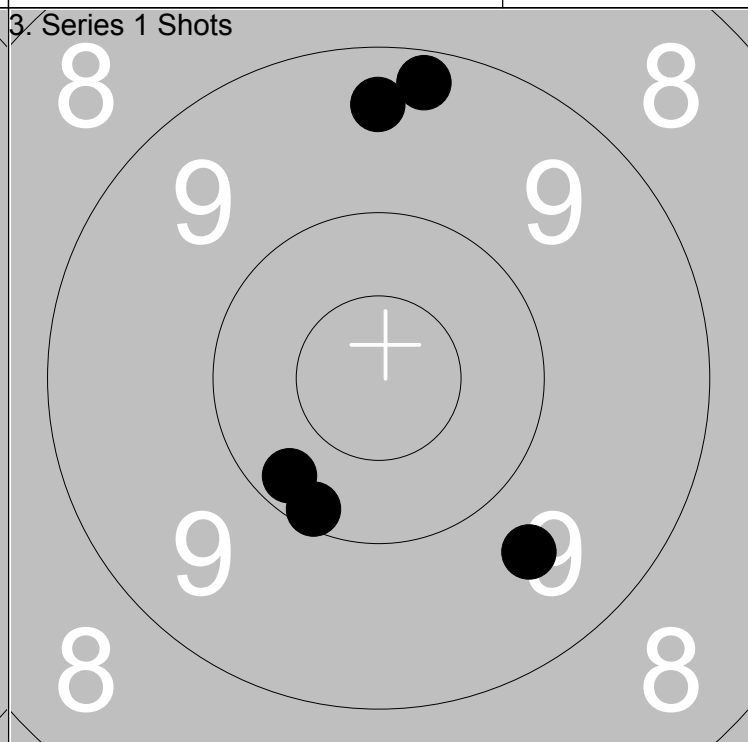
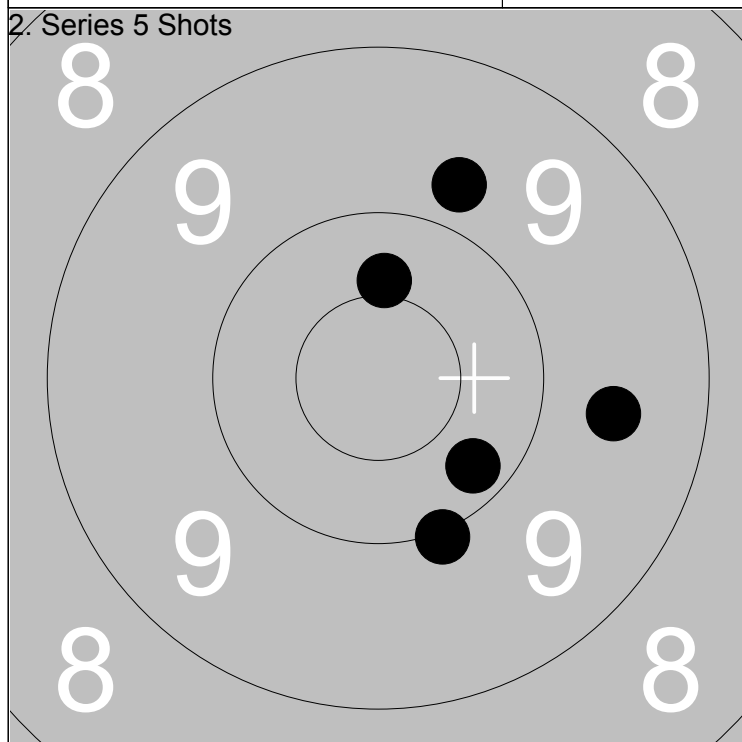

1: 9.6 →	Series	48.0
2: 10.0 ↘		
3: 10.2 ↘		
4: 9.8 ↗		
5: 10.4 ↑		
Total		382.0

1: 9.2 ↑	Series	47.0
2: 9.6 ↘		
3: 9.4 ↑		
4: 10.1 ↘		
5: 10.2 ↘		
Total		429.0

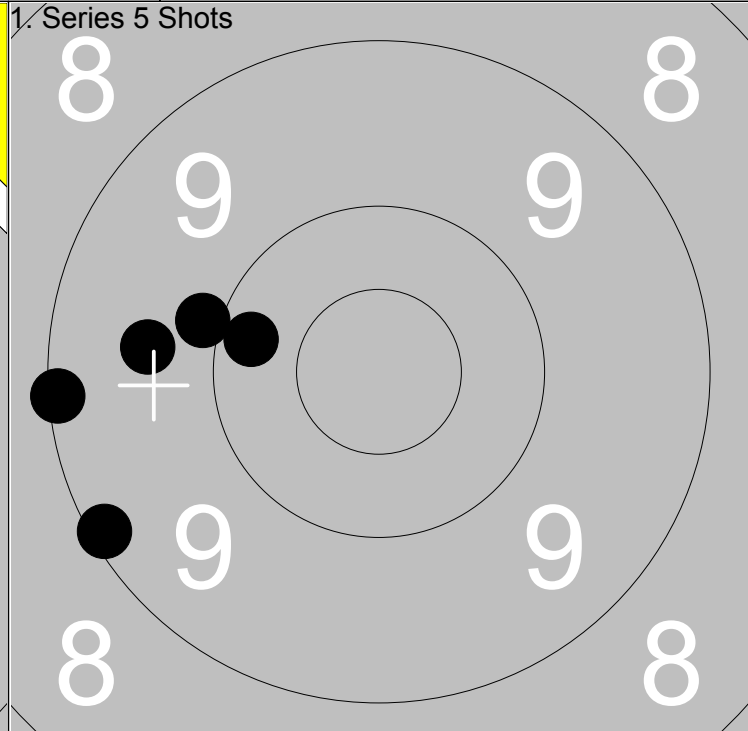
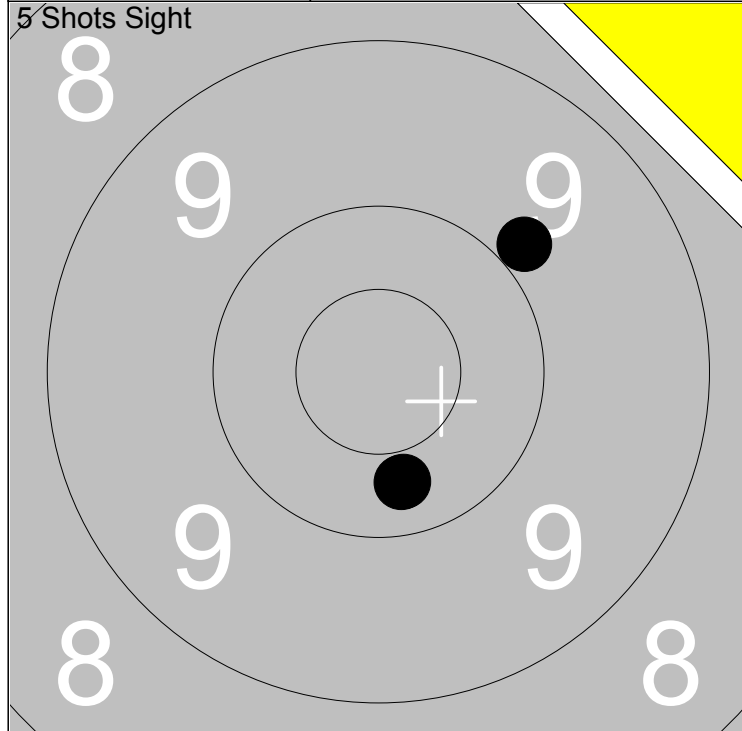

1: 10.3 ↓	Series	29.0
2: 9.9 ↗		
3: 10.3 ↓		
Total		281.0

1: 10.2 ←	Series	46.0
2: 9.9 ←		
3: 9.1 ←		
4: 9.6 ←		
5: 9.1 ←		
Total		327.0

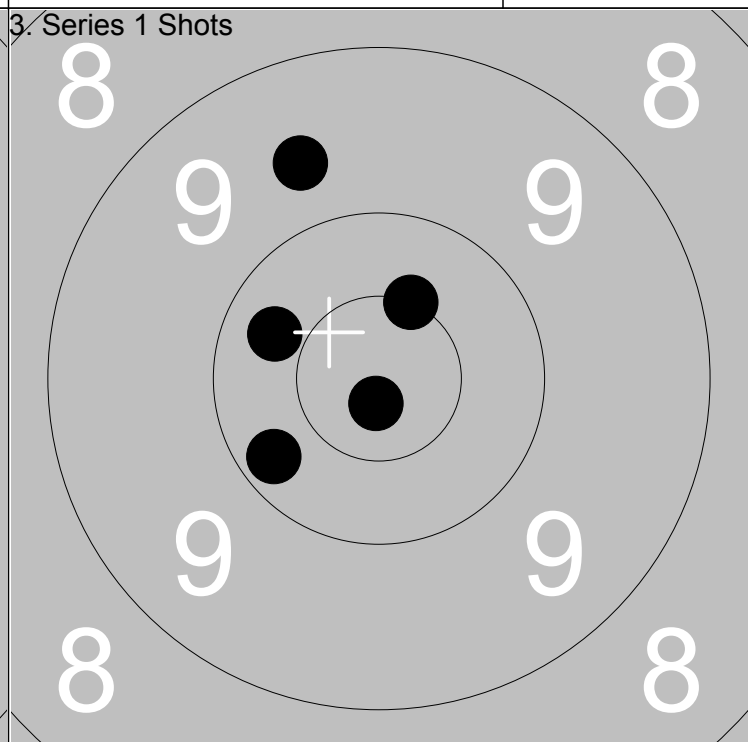
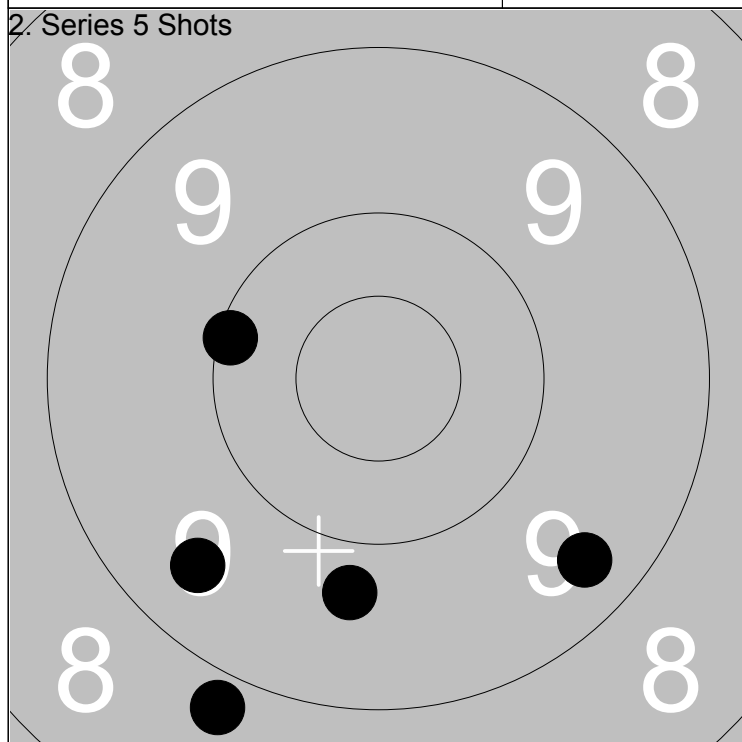

1: 10.1 ←	Series	45.0
2: 9.4 ↘		
3: 9.5 ←		
4: 8.8 ↓		
5: 9.7 ↓		
Total		372.0

1: 10.2 ↙	Series	49.0
2: 9.6 ↗		
3: 10.3 ↙		
4: *10.5 ↗		
5: *10.8 ↓		
Total		421.0

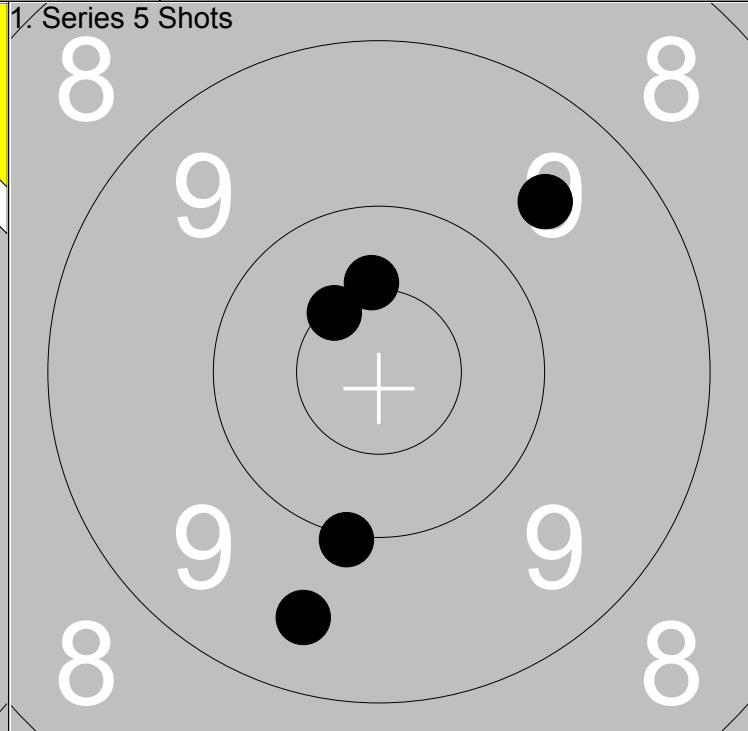
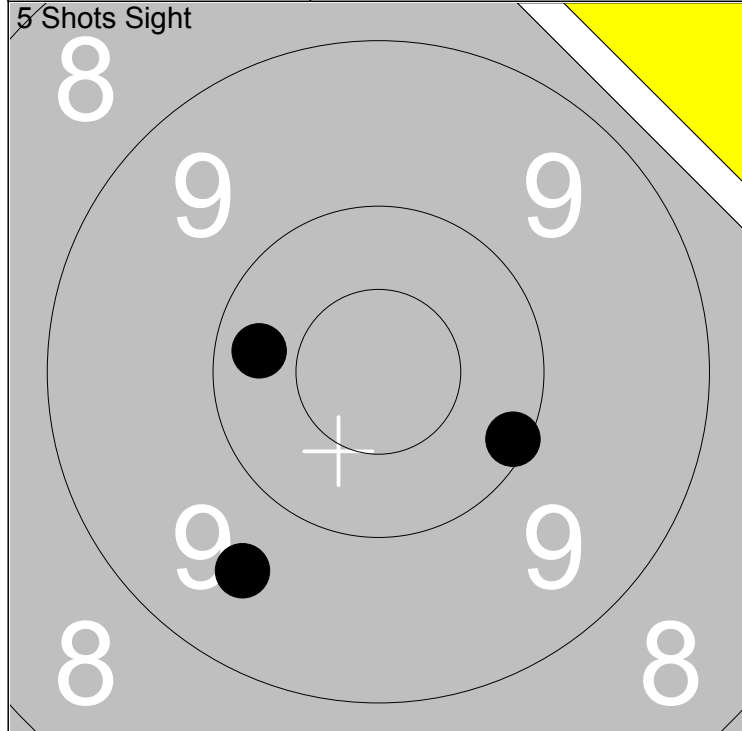

1: 9.6 ↙	Series	29.0
2: 10.1 ➤		
3: 10.3 ←		
Total		279.0

1: 9.6 ↗	Series	48.0
2: 10.0 ↓		
3: *10.5 ↖		
Total		327.0

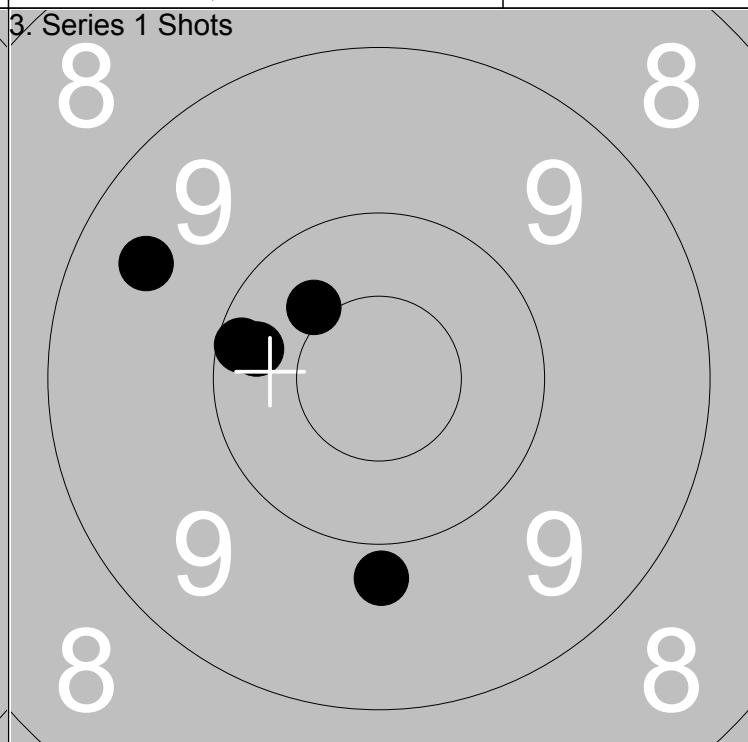
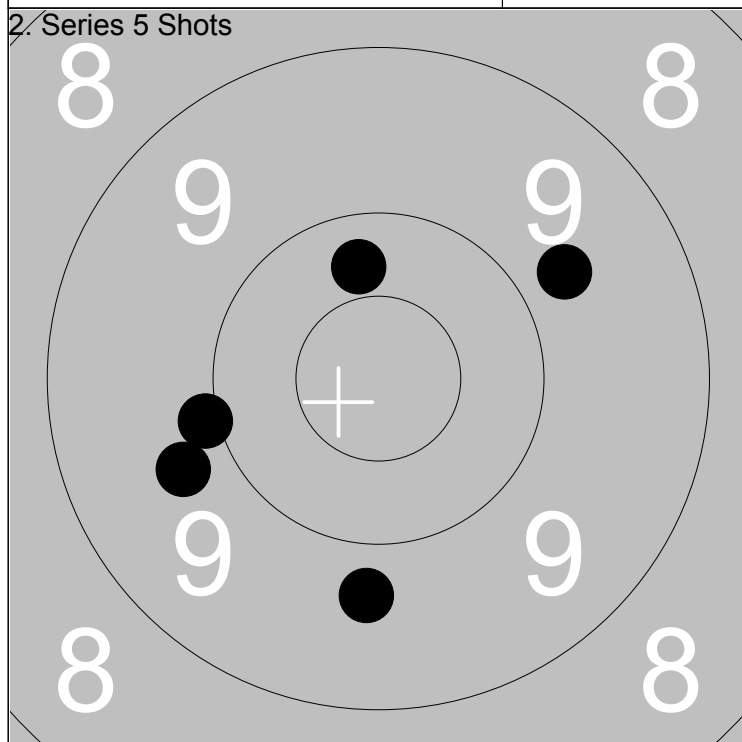

1: 9.7 ←	Series	47.0
2: 9.7 ↗		
3: 10.0 ←		
Total		374.0

1: *10.4 ↖	Series	48.0
2: 10.2 ←		
3: 10.2 ←		
Total		422.0

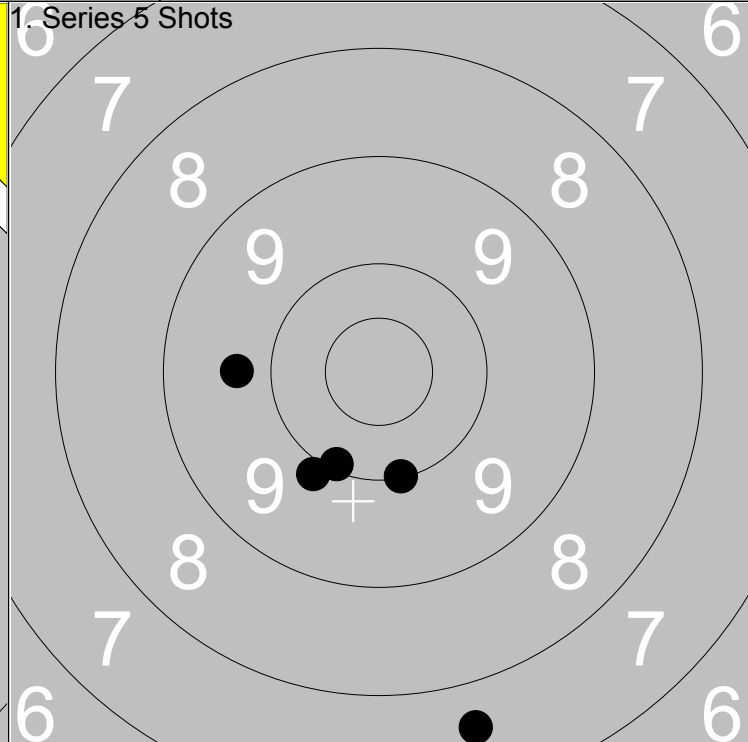
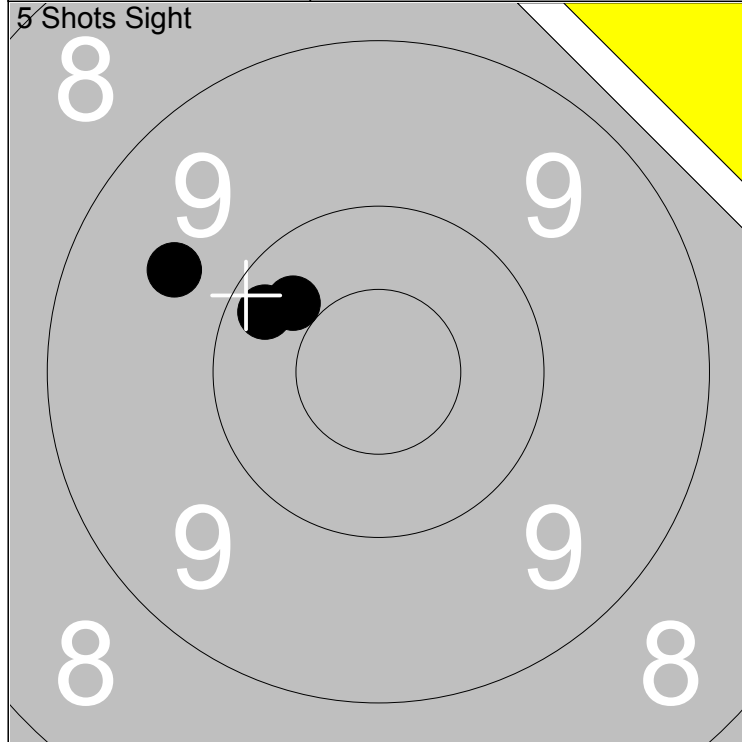

1: 10.3 ↖	Series 29.0
2: 9.7 ↖	
3: 10.2 ↖	
Total 272.0	

1: 7.6 ↓	Series 45.0
2: 9.7 ←	
3: 10.1 ↓	
4: 9.9 ↓	
5: 10.0 ↓	
Total 317.0	

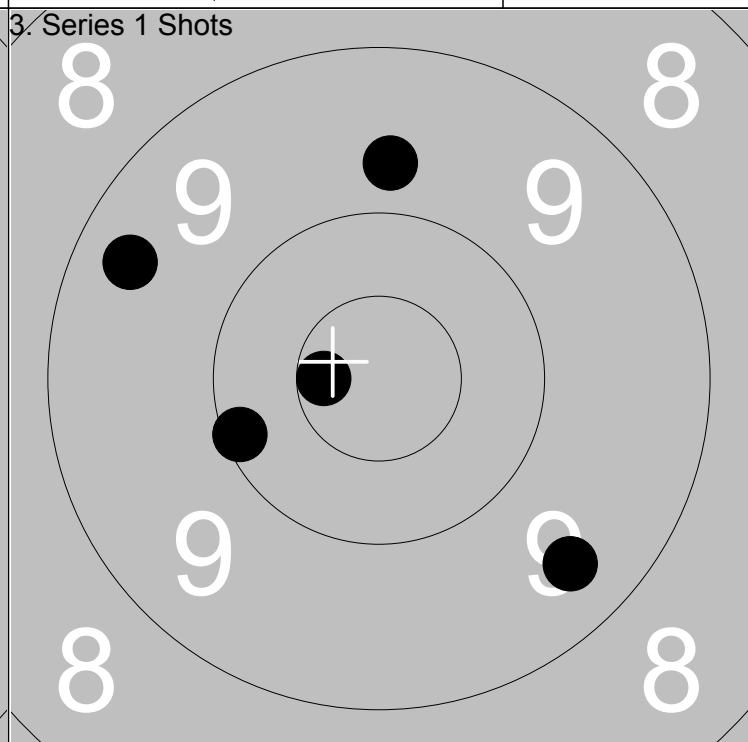
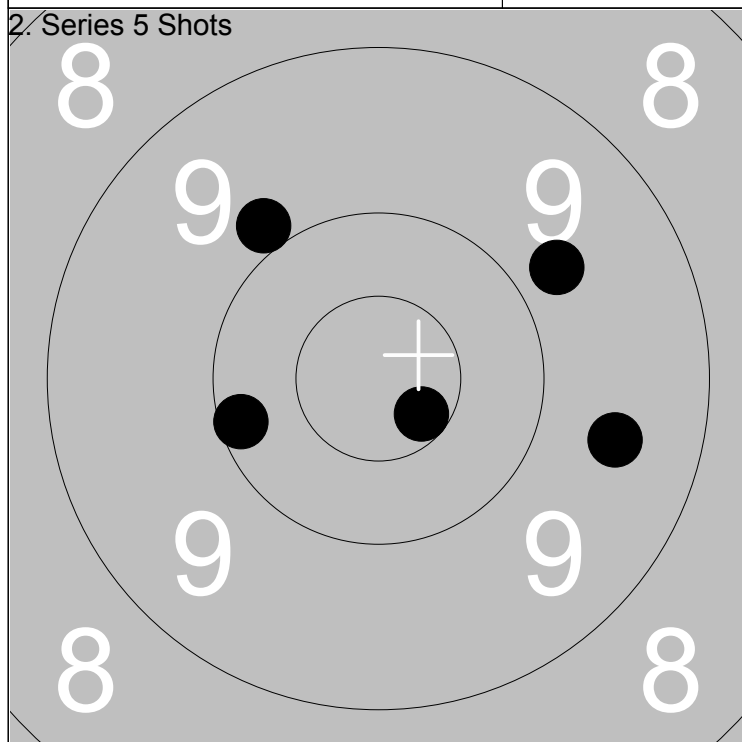

1: 9.9 ↗	Series 47.0
2: 9.8 ↗	
3: 10.1 ←	
4: 9.6 →	
5: *10.6 ↘	
Total 364.0	

1: 9.4 ↓	Series 47.0
2: 10.1 ←	
3: *10.6 ←	
4: 9.7 ↑	
5: 9.4 ↖	
Total 411.0	

Relay <b>4</b>	Lane <b>9</b>	<b>Victor Isaksson</b>
-------------------	------------------	------------------------

300m	Loos	9	Gä
------	------	---	----

07.07.2014	Tavelträffen B 2014	Ramselefors SKF
------------	---------------------	-----------------

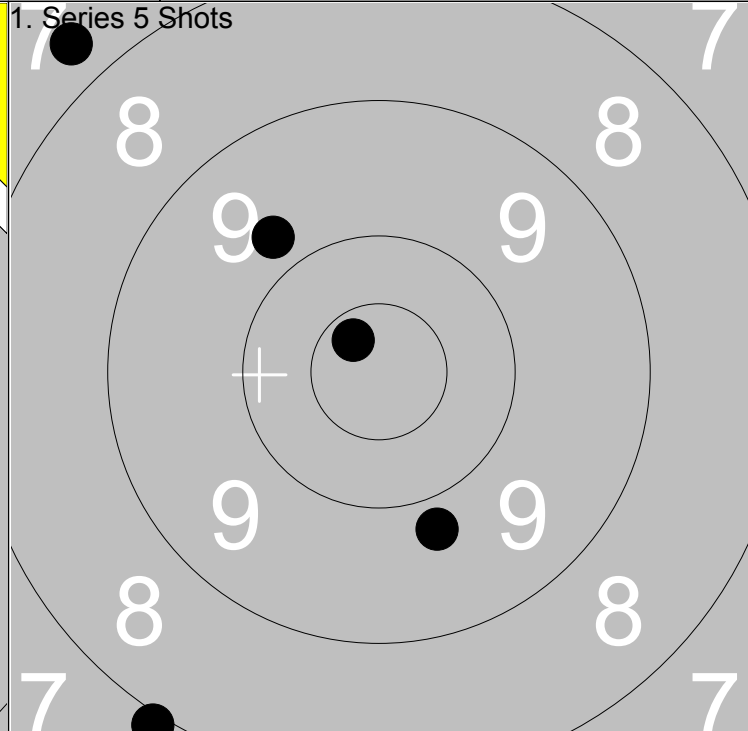
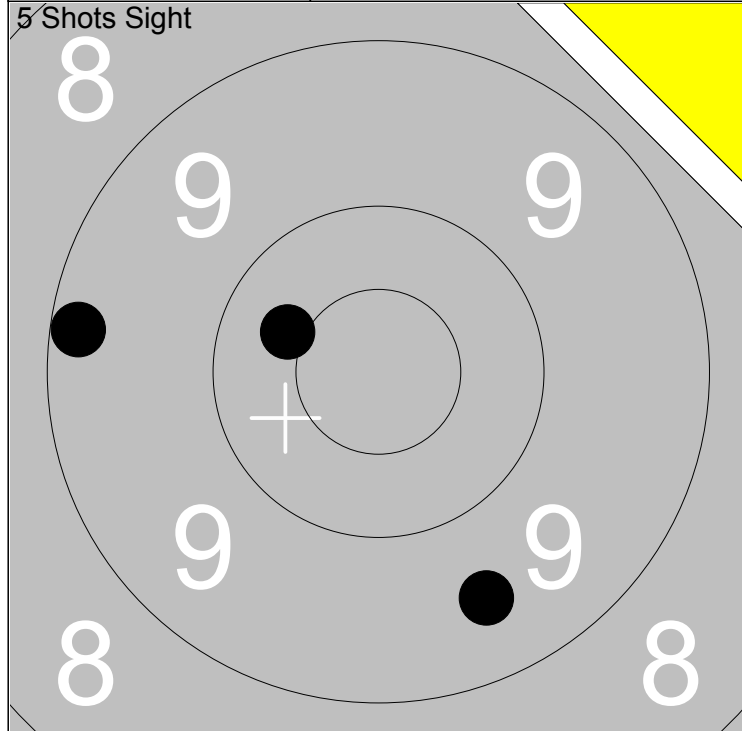

1: 9.5 ↓	Series	28.0
2: 9.2 ←		
3: 10.4 ↖		
Total		280.0

1: 7.9 ↙	Series	42.0
2: 9.8 ↓		
3: 7.7 ↗		
4: 9.8 ↗		
5: *10.7 ↗		
Total		322.0

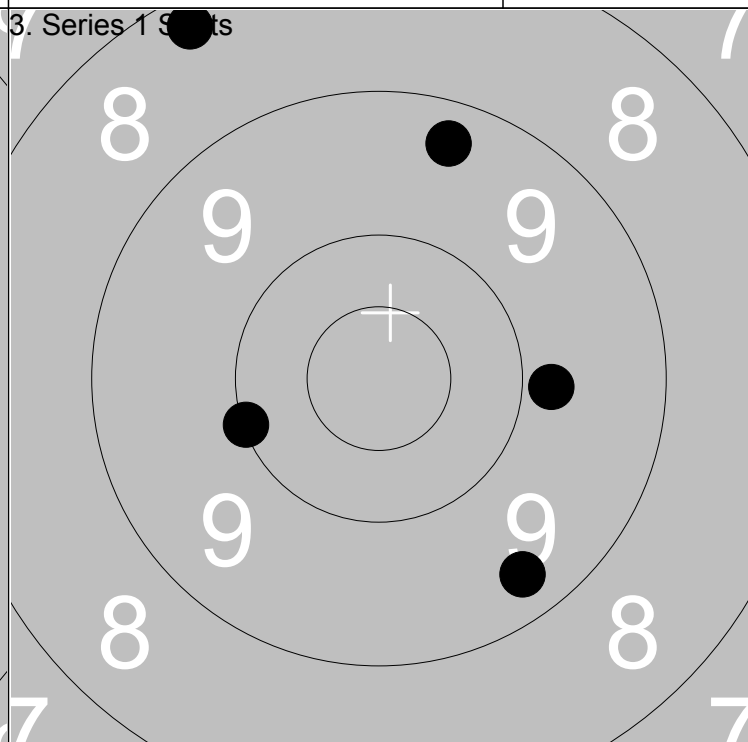
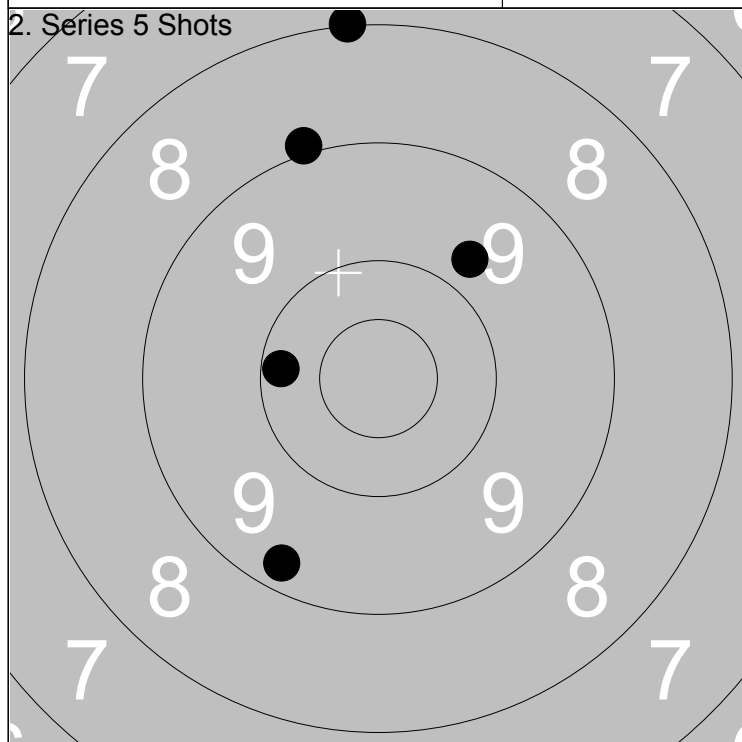

1: 9.0 ↑	Series	45.0
2: 9.8 ↗		
3: 9.3 ↓		
4: 10.2 ←		
5: 8.0 ↑		
Total		367.0

1: 9.3 ↑	Series	45.0
2: 10.0 ←		
3: 8.2 ↗		
4: 9.3 ↓		
5: 9.8 →		
Total		412.0

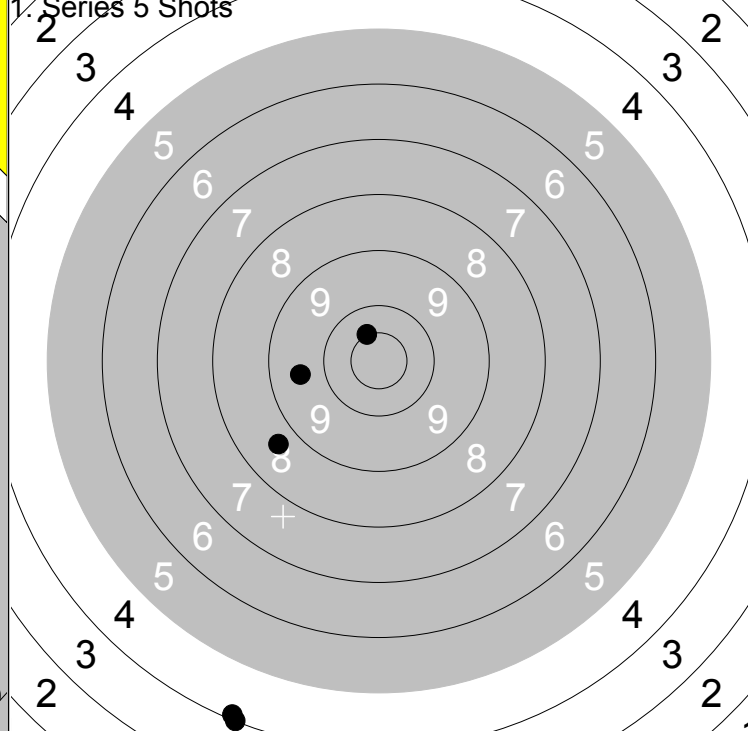
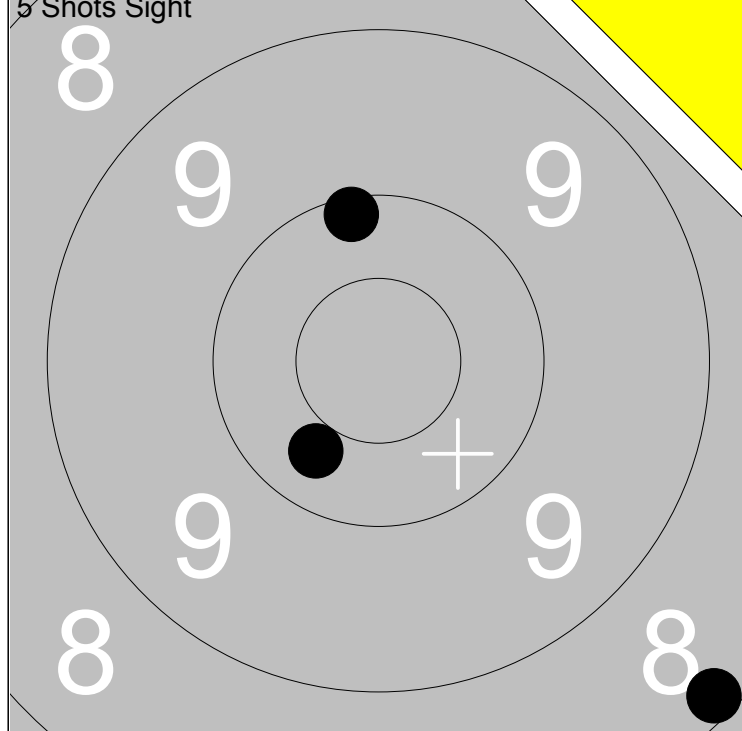

1: 8.2 ↘	Series	28.0
2: 10.3 ↙		
3: 10.1 ↑		
Total		269.0

1: 9.6 ←	Series	35.0
2: 8.7 ↙		
3: 4.0 ↓		
4: *10.5 ↗		
5: 4.1 ↓		
Total		304.0

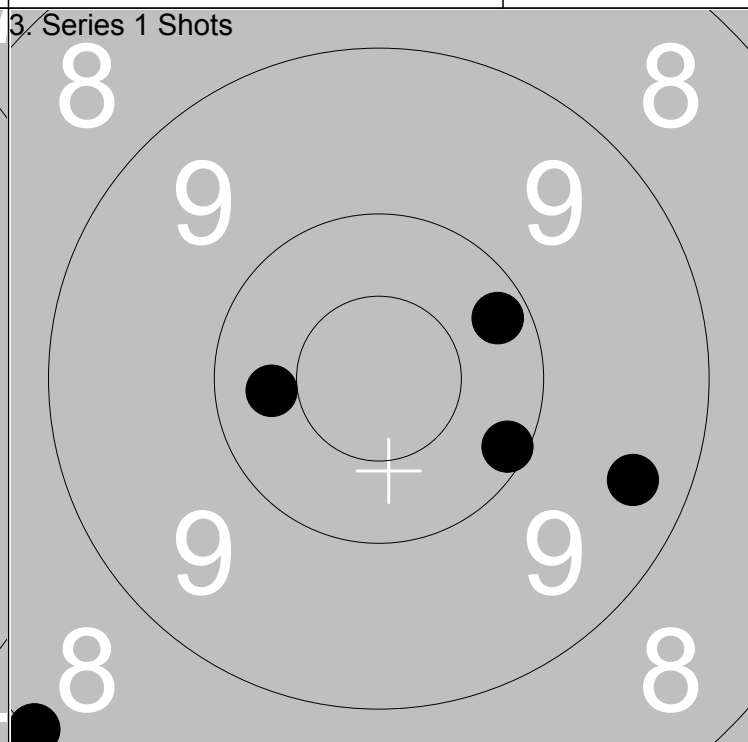
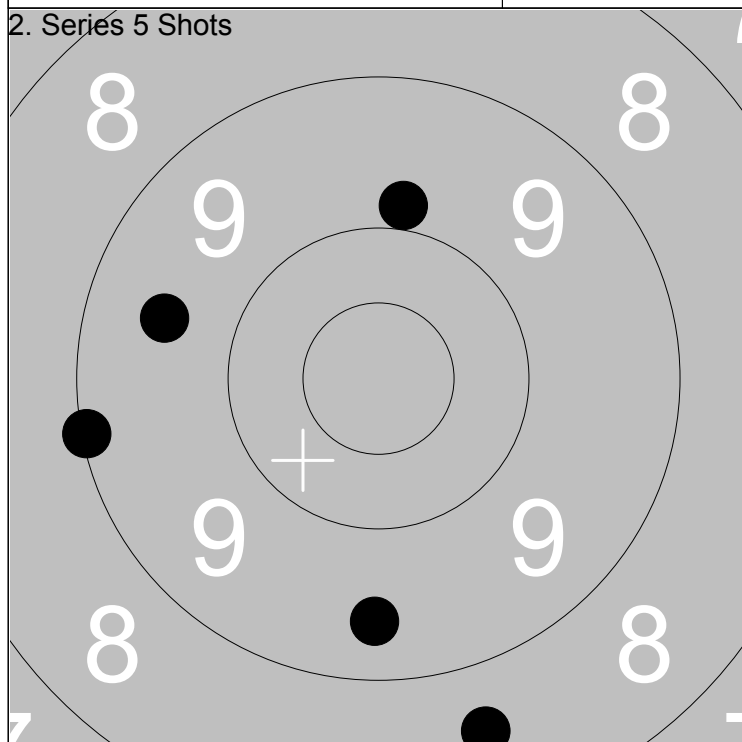

1: 9.6 ←	Series	44.0
2: 9.4 ↓		
3: 9.9 ↑		
4: 9.1 ←		
5: 8.6 ↓		
Total		348.0

1: 10.2 ↗	Series	47.0
2: 9.4 →		
3: 8.1 ↙		
4: 10.3 ←		
5: 10.1 →		
Total		395.0

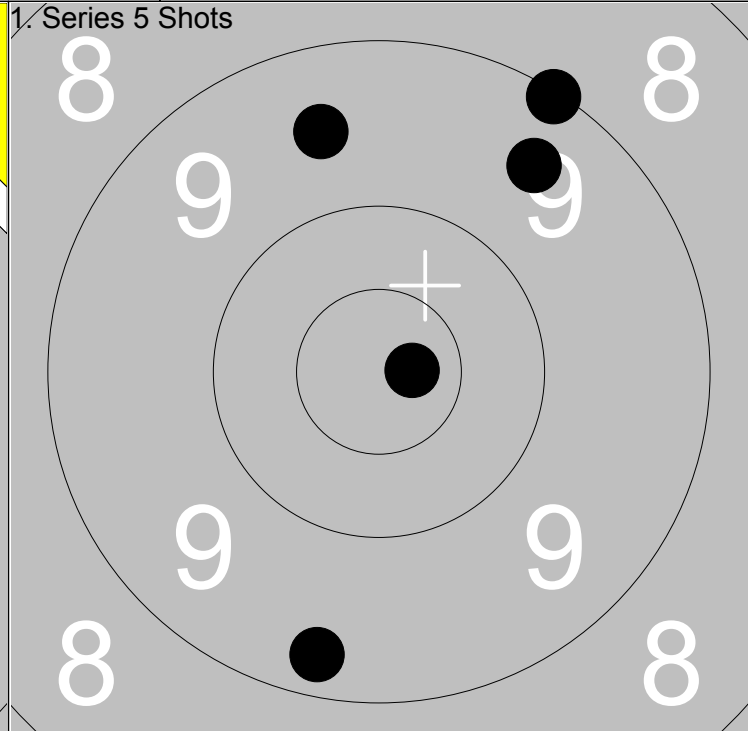
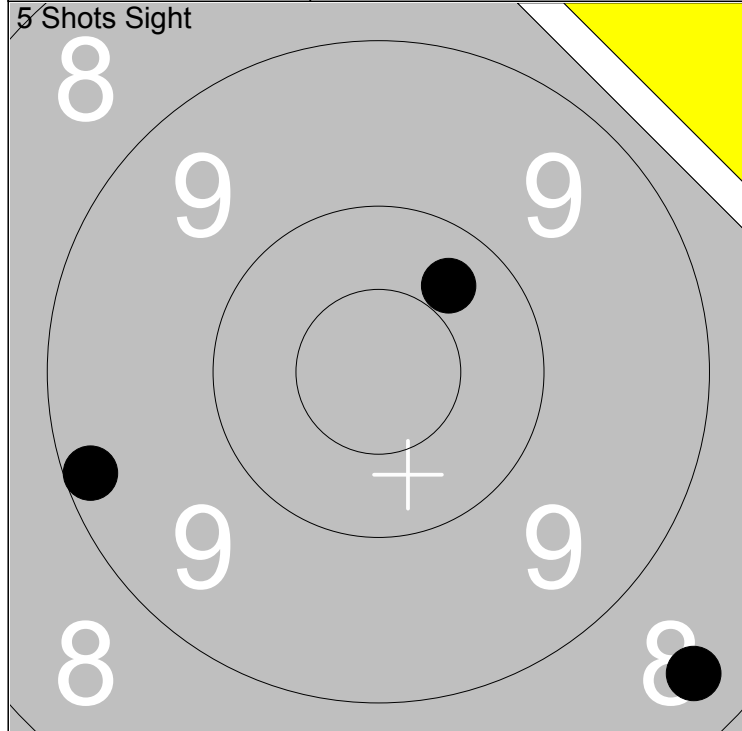

1: 8.4 ↘	Series	27.0
2: 10.3 ↗		
3: 9.2 ←		
Total		267.0

1: 9.3 ↓	Series	46.0
2: *10.8 →		
3: 9.5 ↑		
4: 9.5 ↗		
5: 9.1 ↗		
Total		313.0

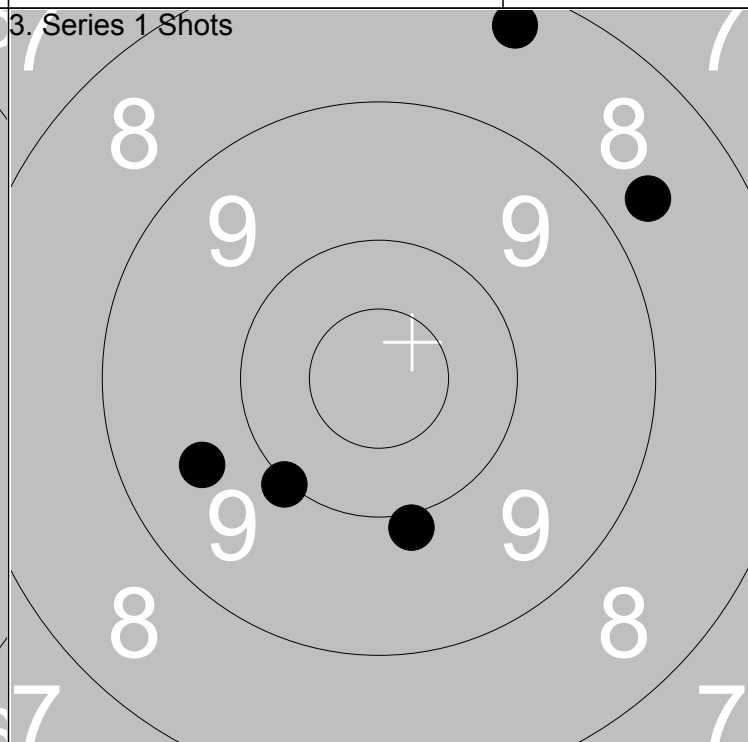
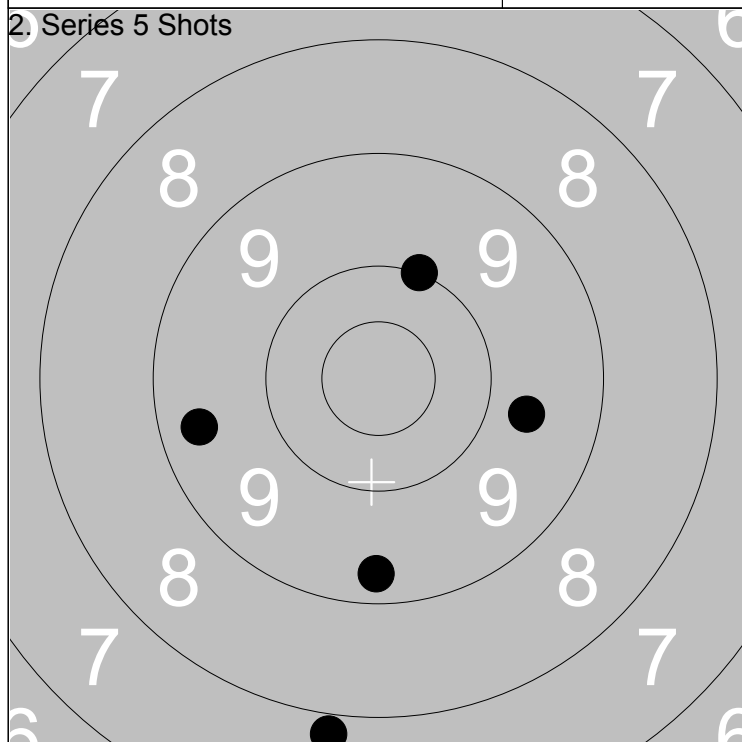

1: 7.9 ↓	Series	44.0
2: 9.7 →		
3: 9.4 ←		
4: 9.3 ↓		
5: 10.0 ↑		
Total		357.0

1: 10.0 ↙	Series	44.0
2: 8.3 ↑		
3: 9.9 ↓		
4: 8.7 ↗		
5: 9.6 ↙		
Total		401.0

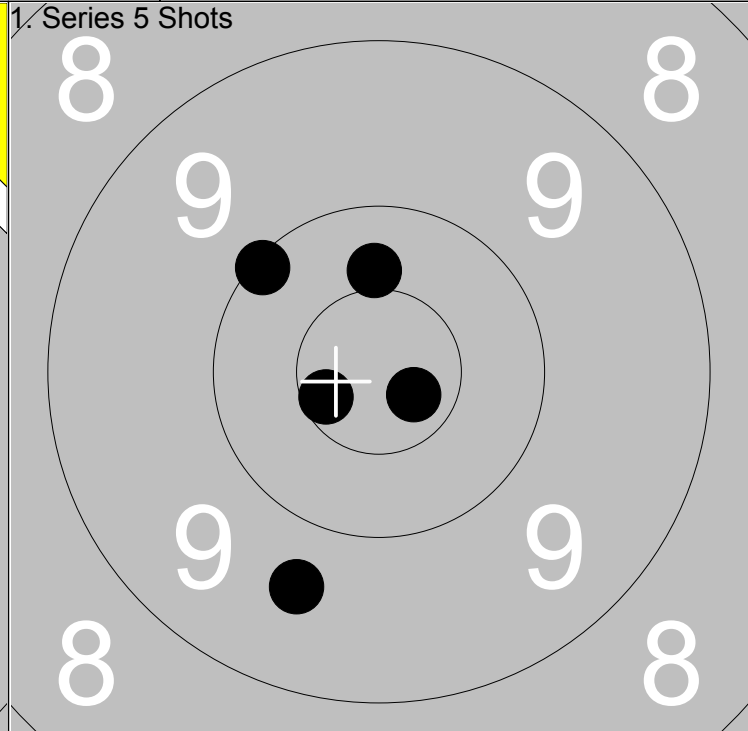
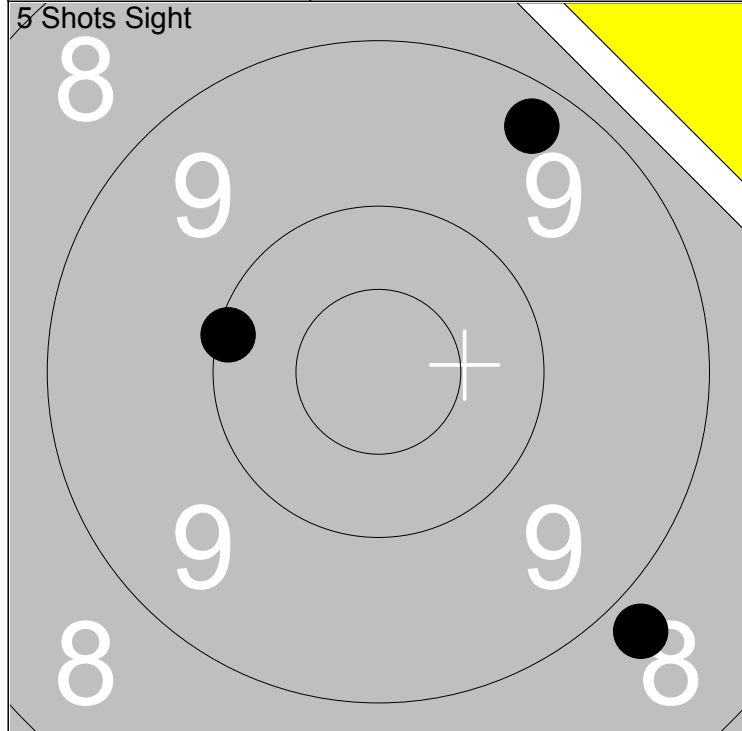

1: 8.8 ↘	Series	27.0
2: 9.3 ↗		
3: 10.1 ←		
Total		286.0

1: *10.6 ↙	Series	49.0
2: 10.1 ↖		
3: 9.6 ↓		
Total		335.0

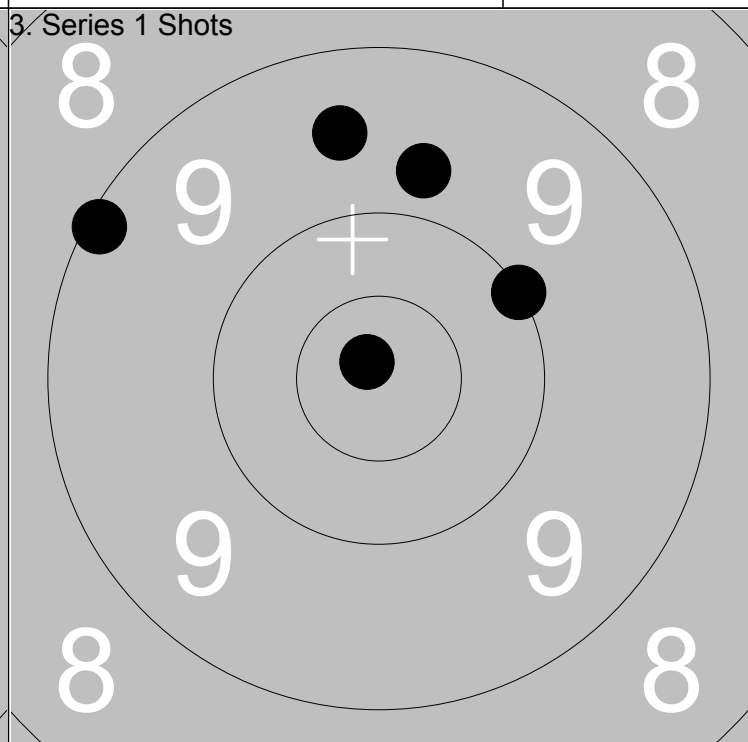
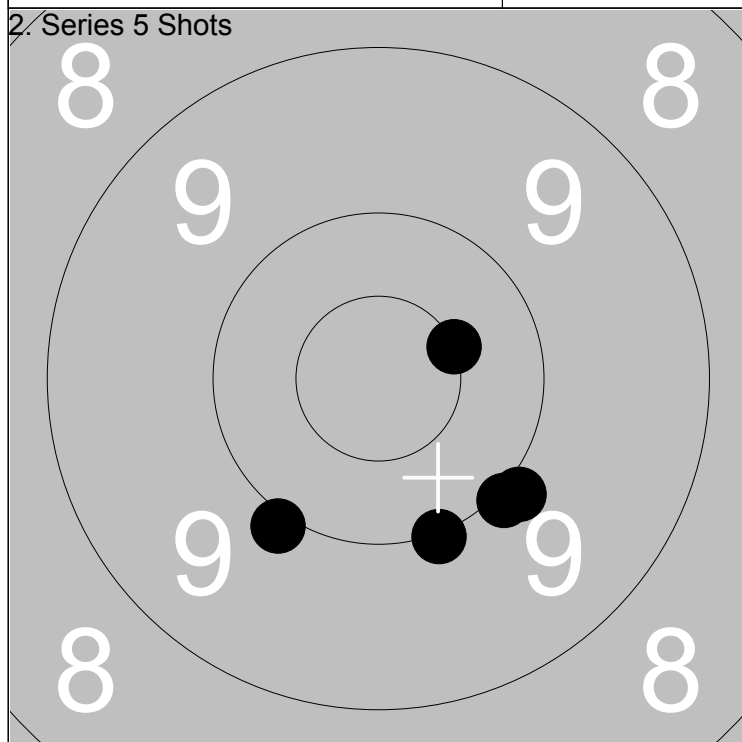

1: 9.9 ↘	Series	48.0
2: 10.0 ↘		
3: *10.5 ↗		
Total		383.0

1: *10.8 ↖	Series	47.0
2: 9.7 ↗		
3: 9.1 ↖		
Total		430.0



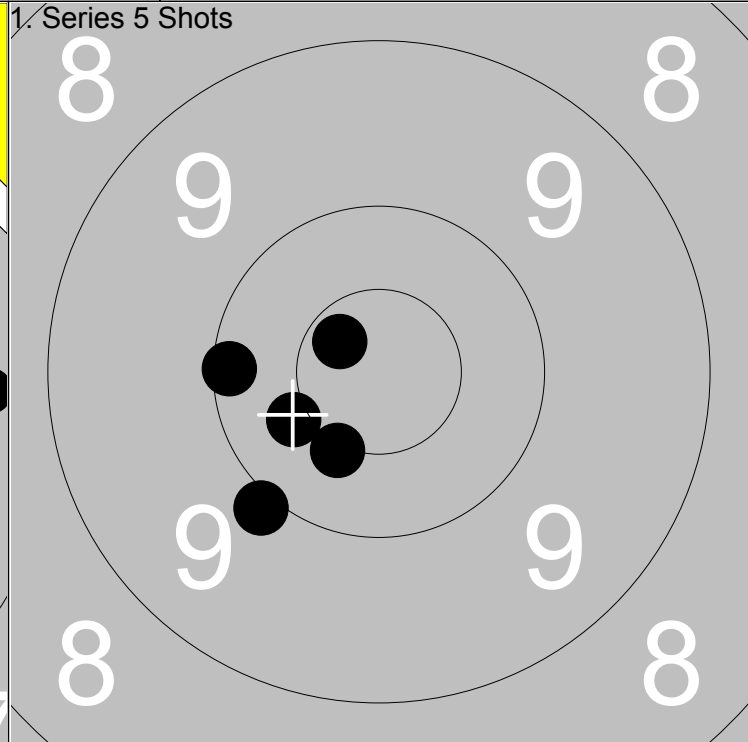
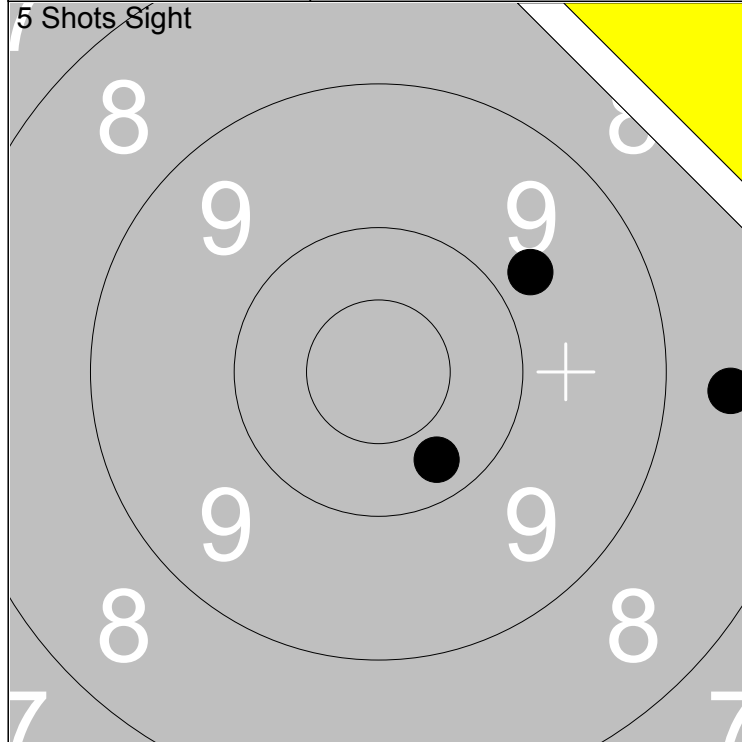

1: 10.3 ↘	Series	27.0
2: 8.6 →		
3: 9.8 ↗		
Total		286.0

1: 10.1 ←	Series	49.0
2: 9.9 ↘		
3: 10.4 ↙		
Total		335.0

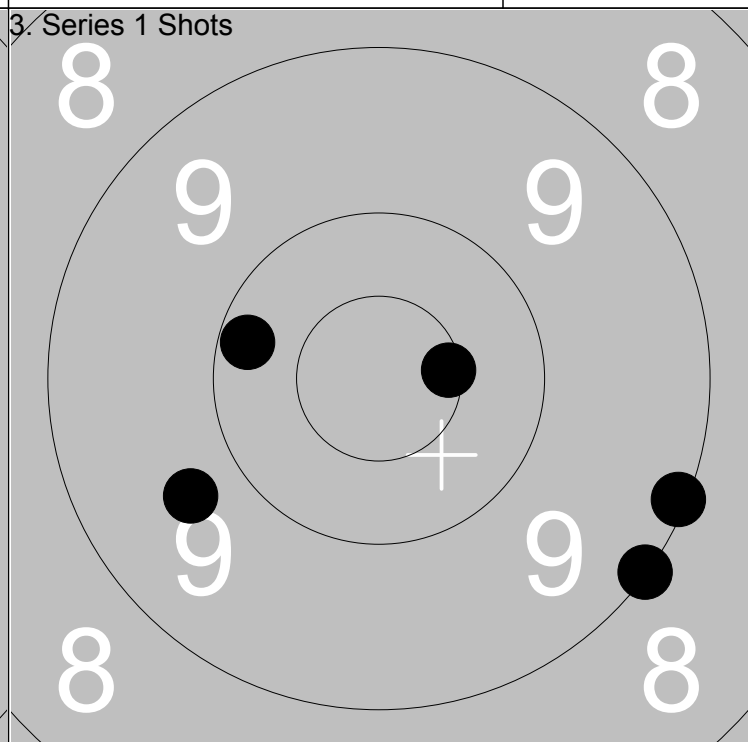
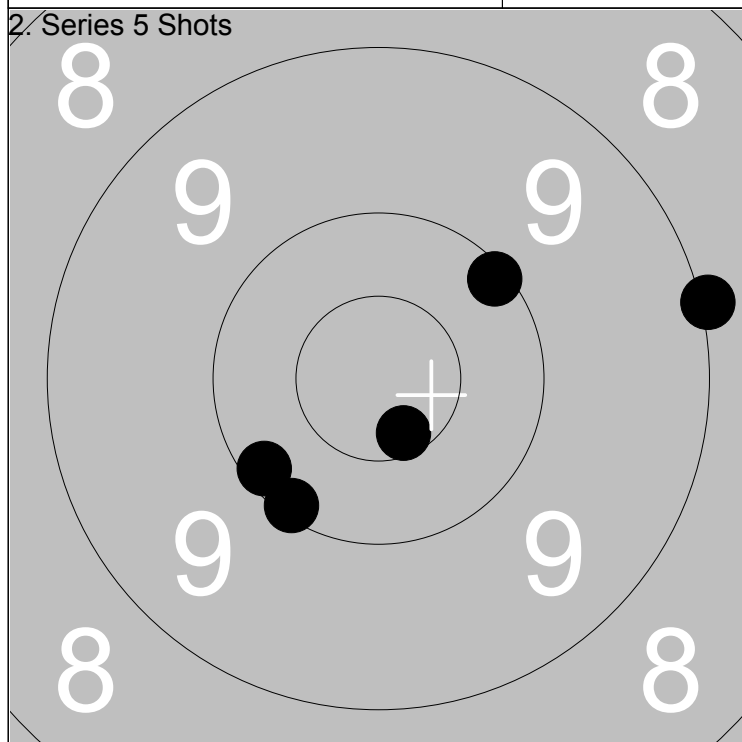

1: 10.1 ↗	Series	49.0
2: *10.6 ↘		
3: 9.0 →		
Total		384.0

1: 10.2 ←	Series	47.0
2: *10.6 →		
3: 9.0 ↘		
Total		431.0

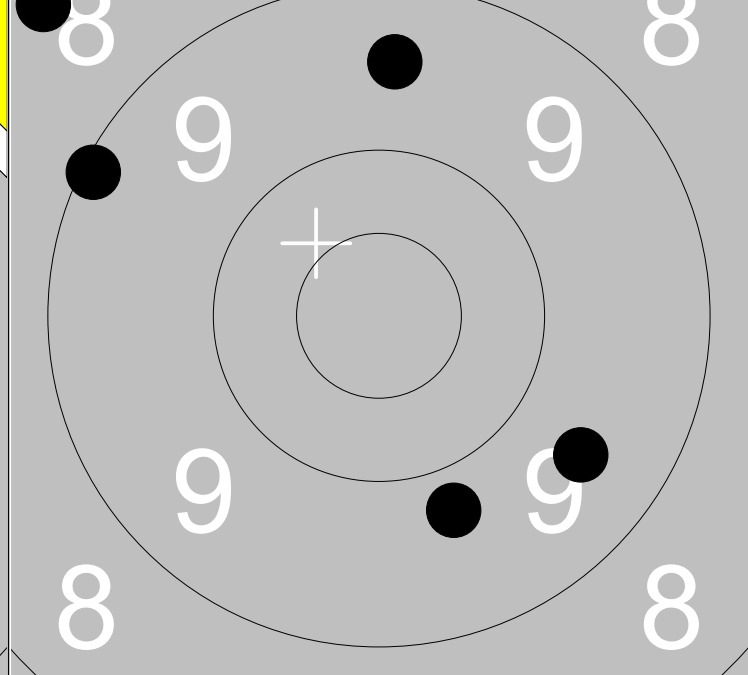
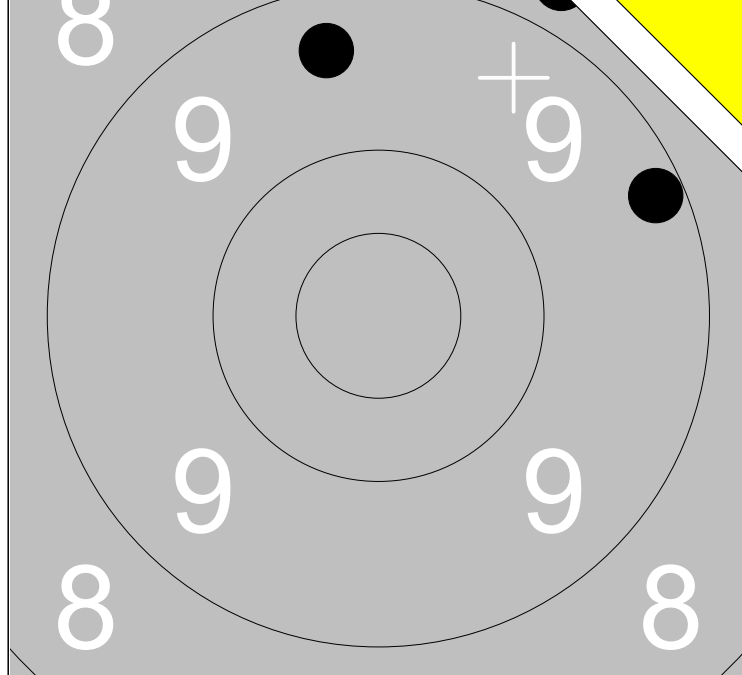

1: 9.2 →	Series    26.0
2: 8.7 ↗	
3: 9.4 ↑	
Total    284.0	

1: 8.3 ↗	Series    44.0
2: 9.6 ↘	
3: 9.5 ↑	
4: 9.1 ↖	
5: 9.8 ↘	
Total    328.0	

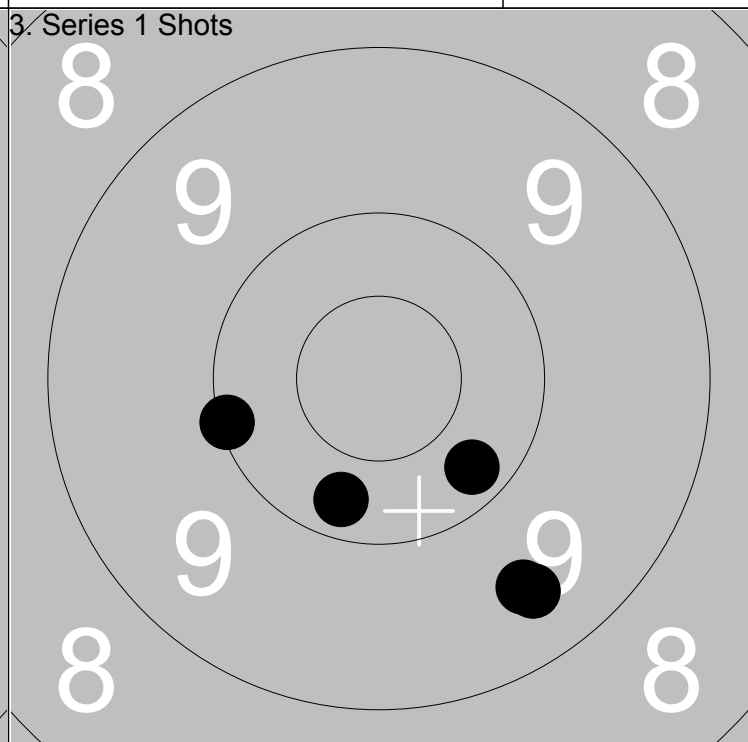
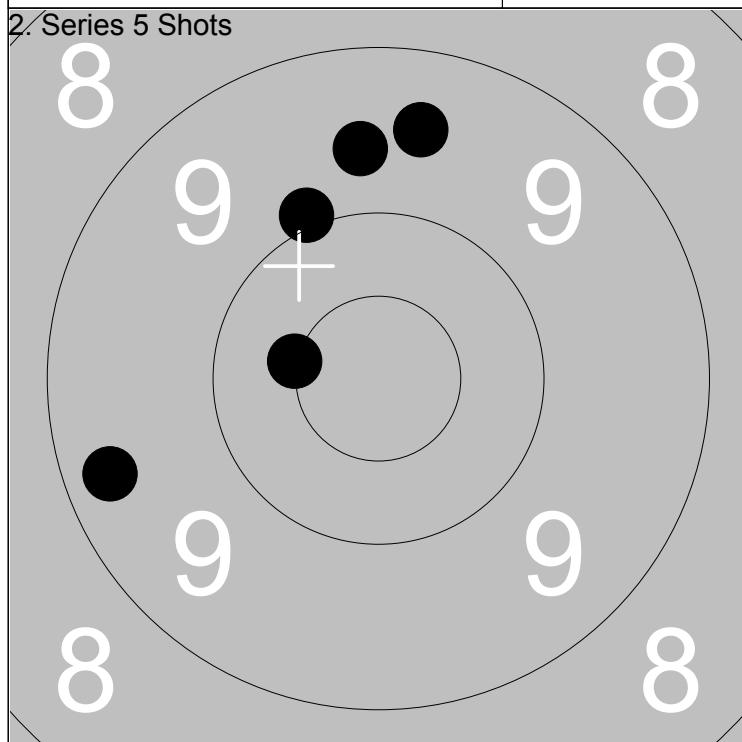

1: 10.0 ↖	Series    47.0
2: 9.5 ↑	
3: 9.6 ↑	
4: *10.5 ←	
5: 9.3 ←	
Total    375.0	

1: 10.2 ↓	Series    48.0
2: 10.2 ↘	
3: 10.1 ←	
4: 9.4 ↘	
5: 9.5 ↘	
Total    423.0	

Relay **4** Lane **17** **Emelie Jansson**

300m Kvistbro 17 Ör

07.07.2014 Tavelträffen B 2014 Ramselefors SKF

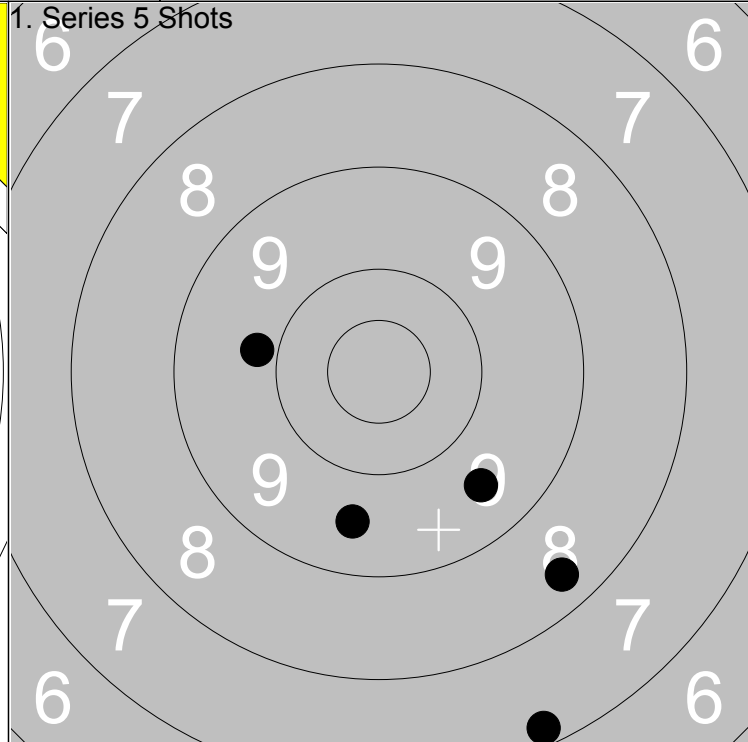
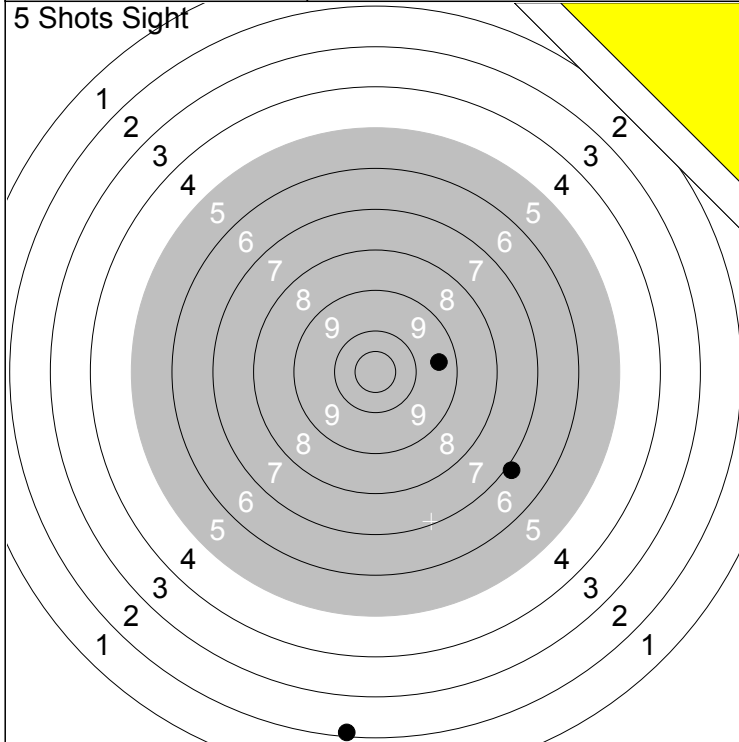

1: 6.9 ↘	Series 17.0
2: 9.5 →	
3: 2.1 ↓	
Total 260.0	

1: 9.8 ←	Series 42.0
2: 9.5 ↘	
3: 9.5 ↓	
4: 7.2 ↓	
5: 8.4 ↘	
Total 302.0	

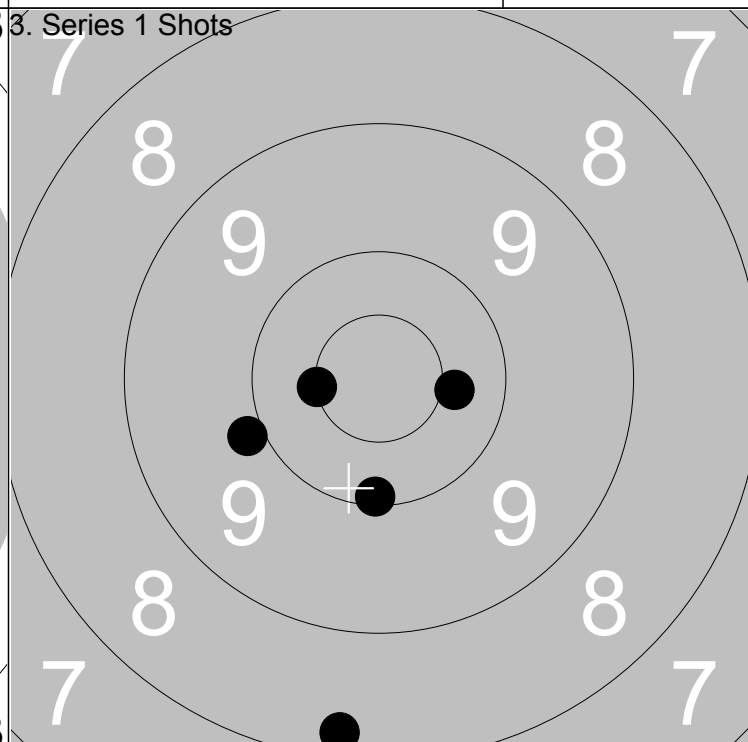
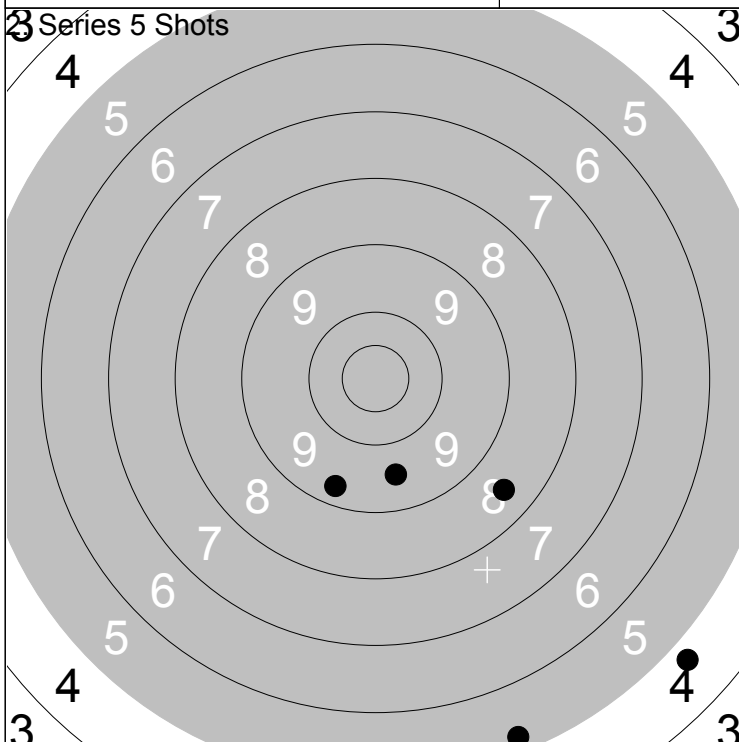

1: 8.5 ↘	Series 35.0
2: 4.7 ↘	
3: 9.6 ↓	
4: 5.2 ↓	
5: 9.3 ↓	
Total 337.0	

1: 10.1 ↓	Series 47.0
2: *10.5 ←	
3: 8.2 ↓	
4: 10.4 →	
5: 9.9 ←	
Total 384.0	

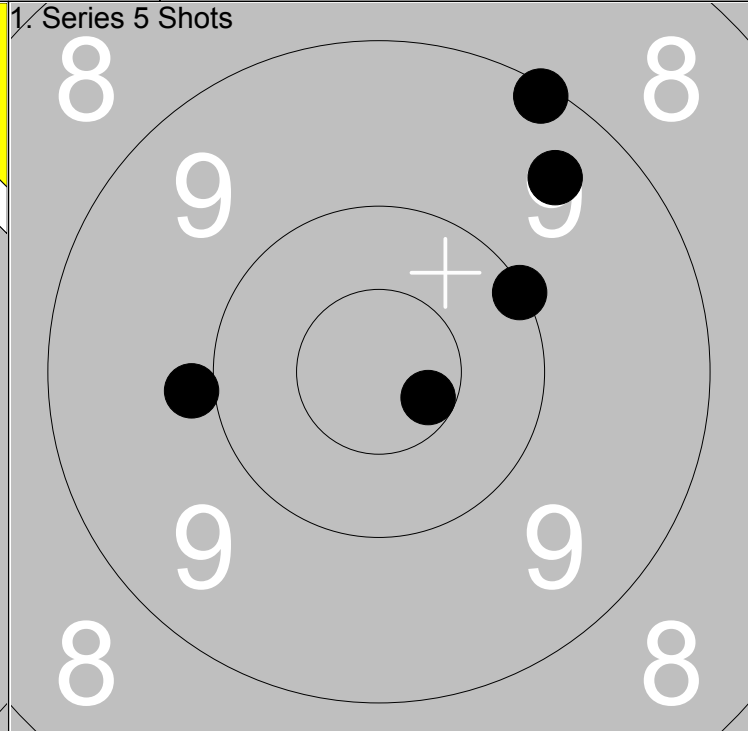
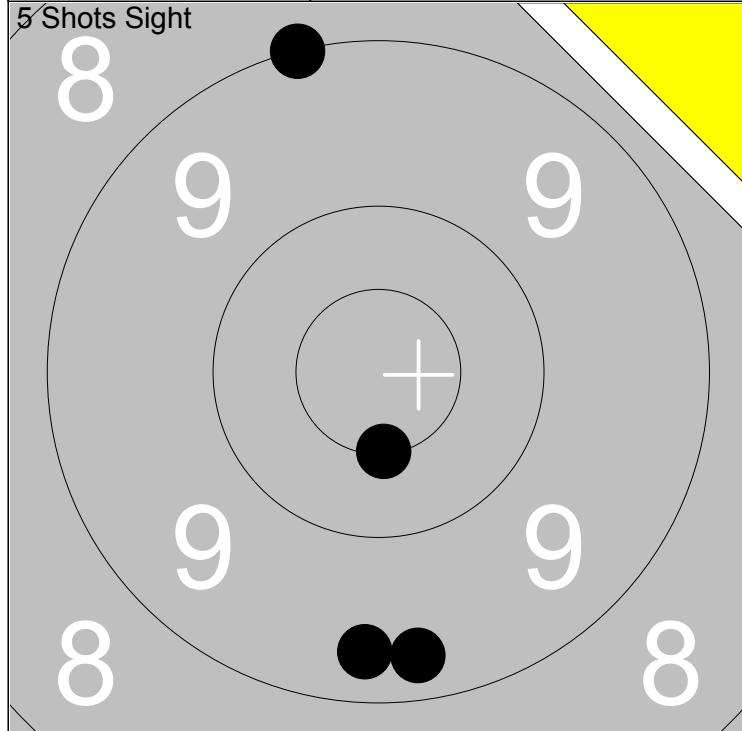

1: *10.5 ↓	Series	45.0
2: 9.3 ↓		
3: 9.3 ↓	Total	287.0
4: 8.7 ↗		
5: 9.0 ↑		

1: 9.4 ↗	Series	47.0
2: *10.6 ➡		
3: 10.0 ↗	Total	334.0
4: 9.1 ↑		
5: 9.9 ←		

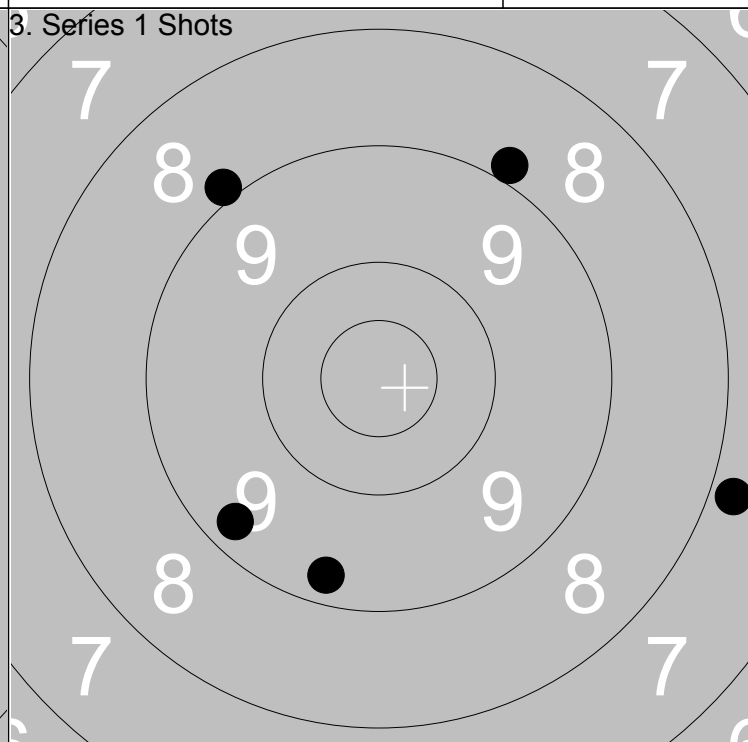
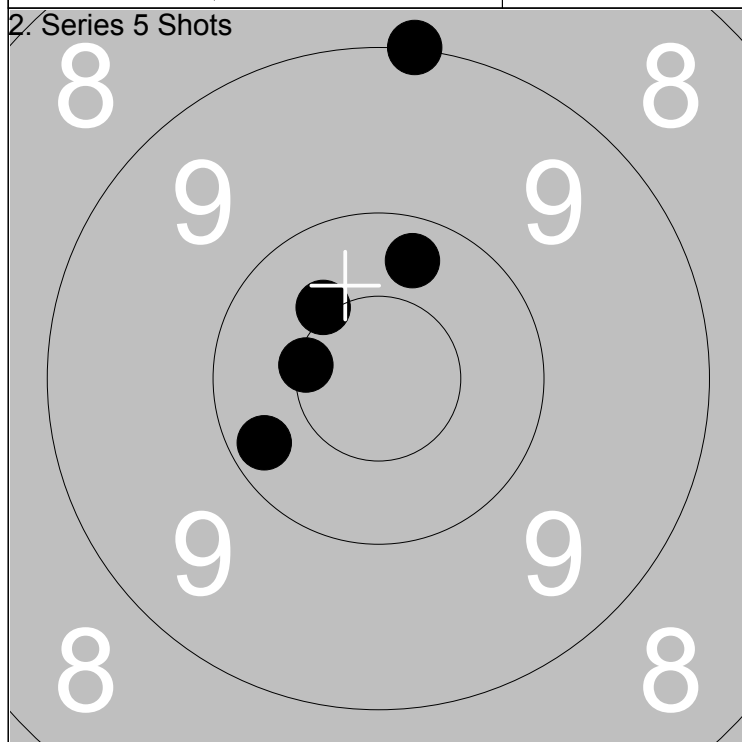

1: *10.5 ↙	Series	49.0
2: *10.4 ↗		
3: 10.3 ↑	Total	383.0
4: 10.2 ↙		
5: 9.0 ↑		

1: 8.9 ↗	Series	41.0
2: 8.9 ↗		
3: 9.3 ↓	Total	424.0
4: 7.8 ➡		
5: 9.3 ↙		

Relay <b>5</b>	Lane <b>2</b>	<b>Markus Andersson</b>
-------------------	------------------	-------------------------

300m	Bälinge-Jumkil	2	Up
------	----------------	---	----

07.07.2014	Tavelträffen B 2014	Ramselefors SKF
------------	---------------------	-----------------

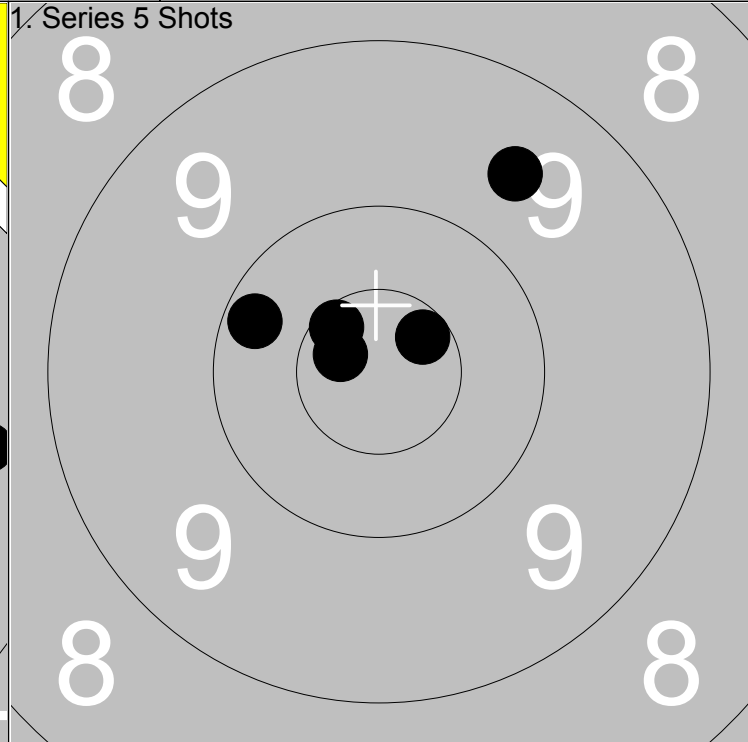
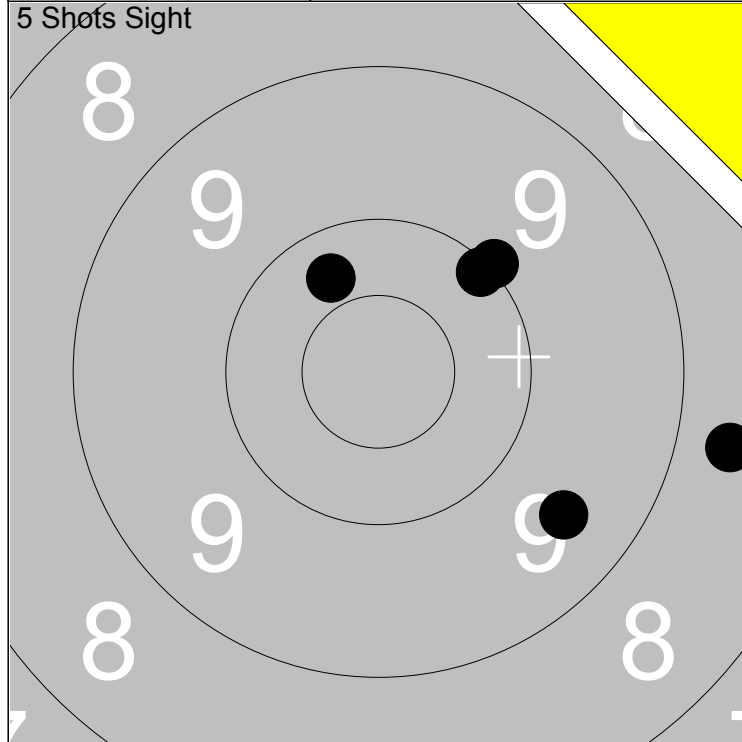

1: 10.1 ↗
2: 10.3 ↖
3: 10.0 ↗
4: 9.5 ↘
5: 8.7 →

Series	47.0
Total	286.0

1: *10.7 ↖
2: *10.6 ↗
3: 9.6 ↗
4: 10.2 ↖
5: *10.6 ↖

Series	49.0
Total	335.0

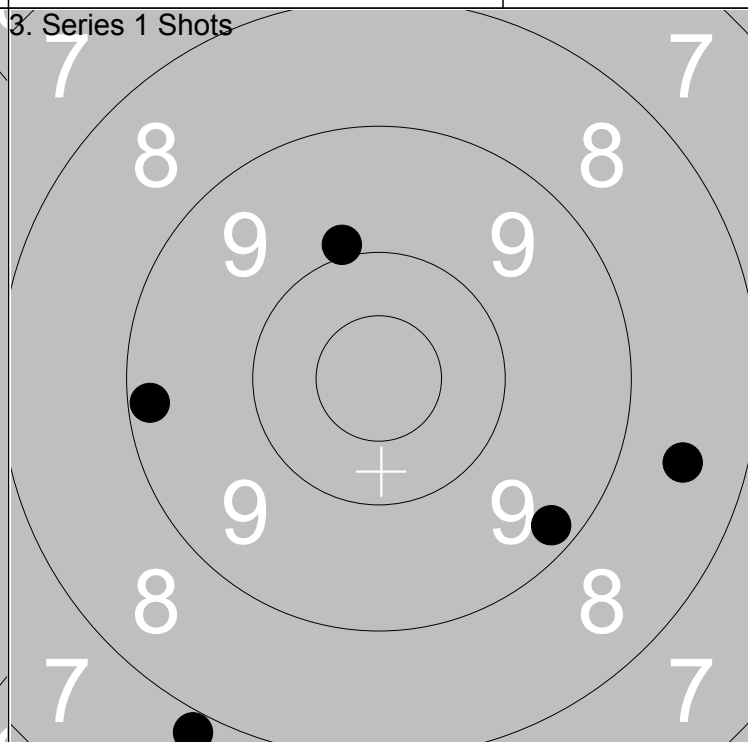
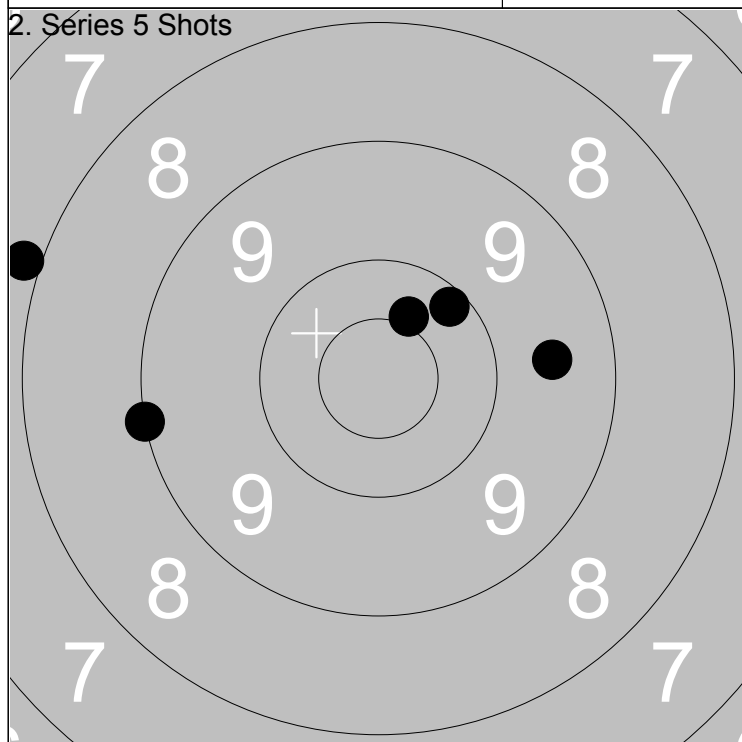

1: 10.4 ↗
2: 7.9 ↖
3: 9.6 →
4: 9.0 ↖
5: 10.2 ↗

Series	45.0
Total	380.0

1: 9.2 ↖
2: 8.5 →
3: 9.2 ↘
4: 7.9 ↘
5: 9.9 ↖

Series	42.0
Total	422.0

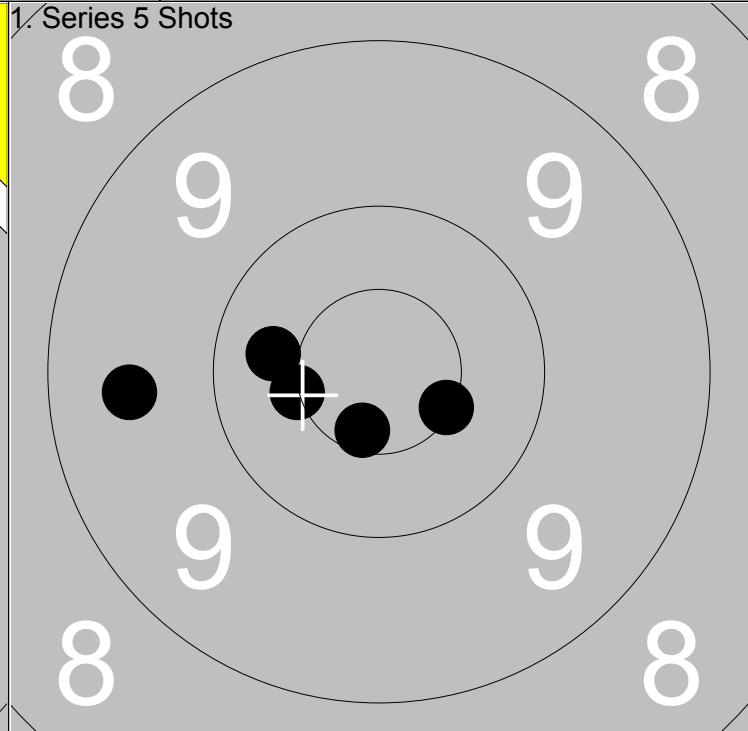
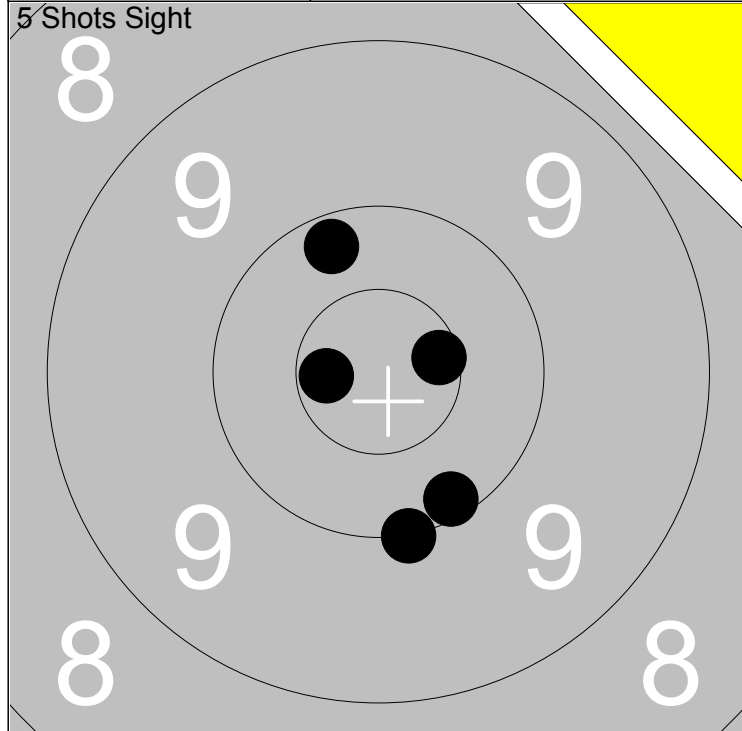

1: 10.1 ↓	Series	50.0
2: 10.2 ↑		
3: *10.6 →	Total	285.0
4: *10.7 ←		
5: 10.0 ↓		

1: *10.6 ↓	Series	49.0
2: *10.5 →		
3: 10.3 ←	Total	334.0
4: *10.5 ←		
5: 9.5 ←		

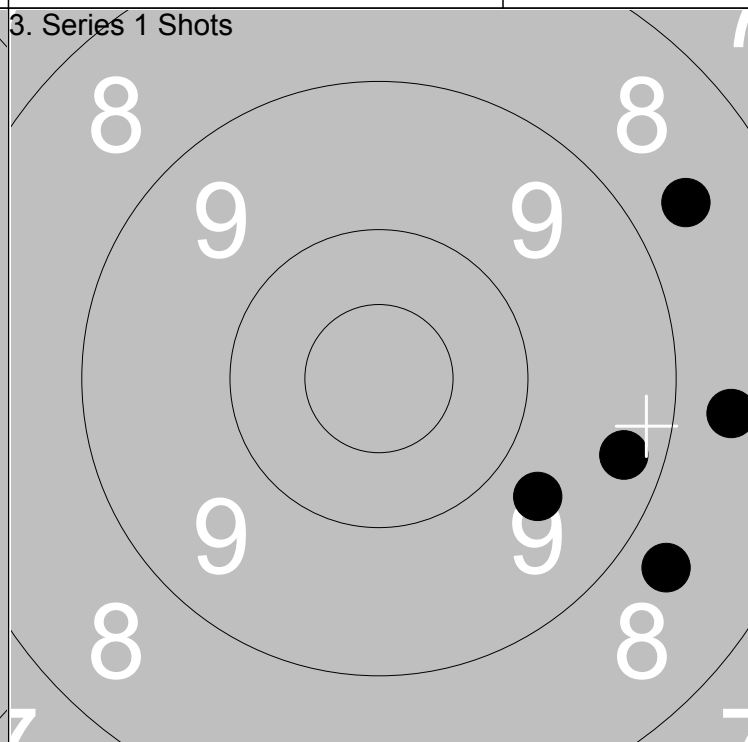
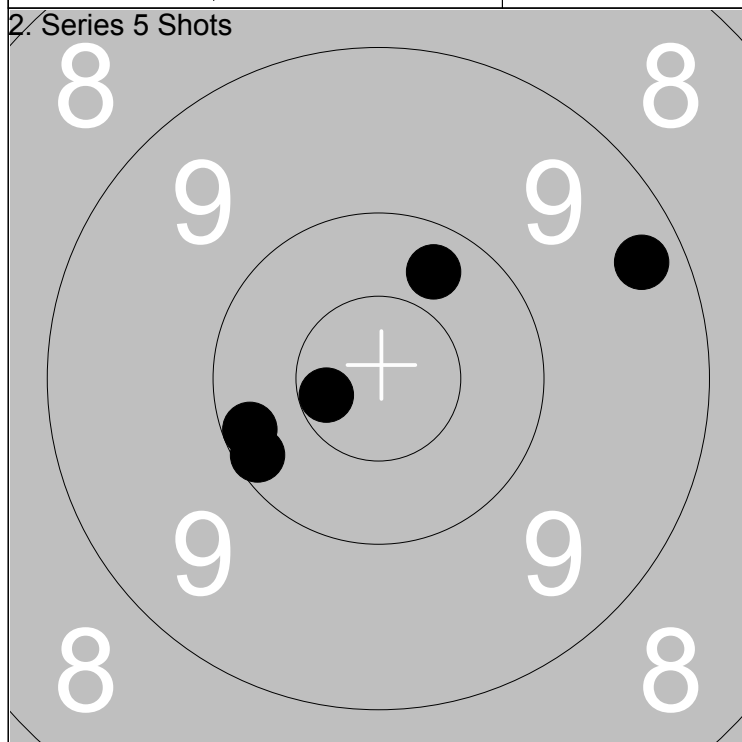

1: 10.3 ↗	Series	49.0
2: 10.1 ←		
3: 9.3 →	Total	383.0
4: *10.6 ←		
5: 10.2 ←		

1: 9.7 ↓	Series	42.0
2: 8.7 →		
3: 9.3 →	Total	425.0
4: 8.7 ↓		
5: 8.6 →		

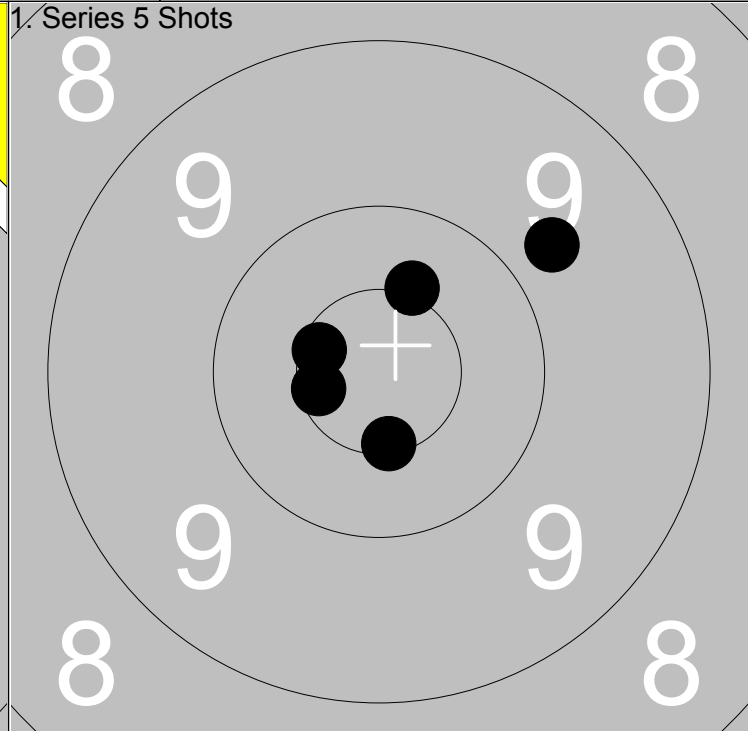
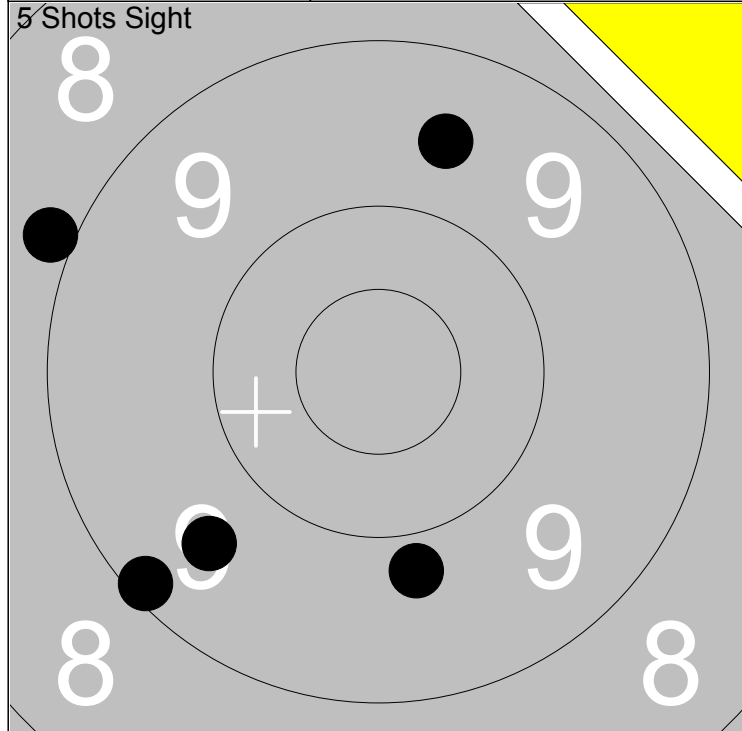

1: 9.1 ↙	Series	44.0
2: 9.8 ↓		
3: 9.6 ↙	Total	282.0
4: 9.6 ↑		
5: 8.9 ↖		

1: 9.7 ↗	Series	49.0
2: *10.6 ↖		
3: *10.6 ↖	Total	331.0
4: *10.4 ↑		
5: *10.5 ↓		

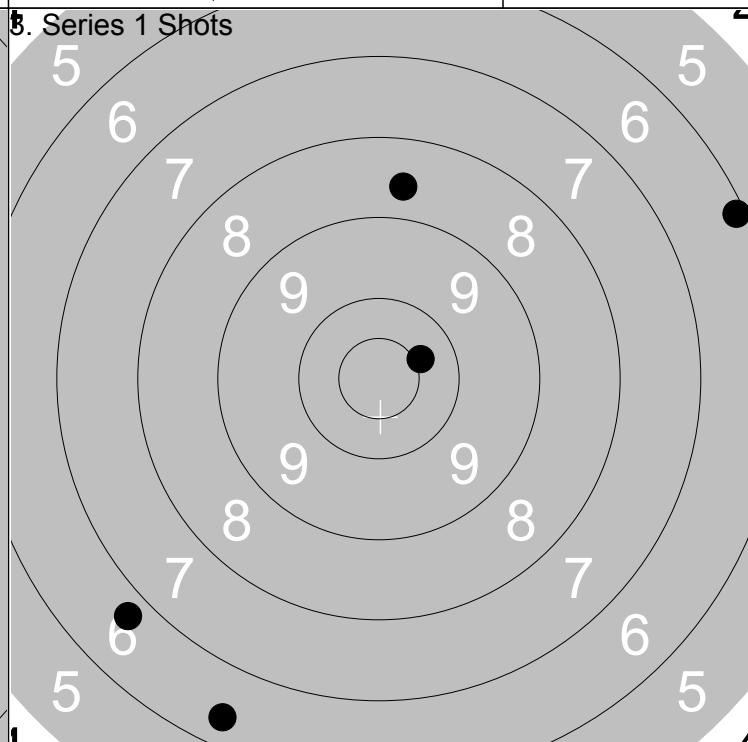
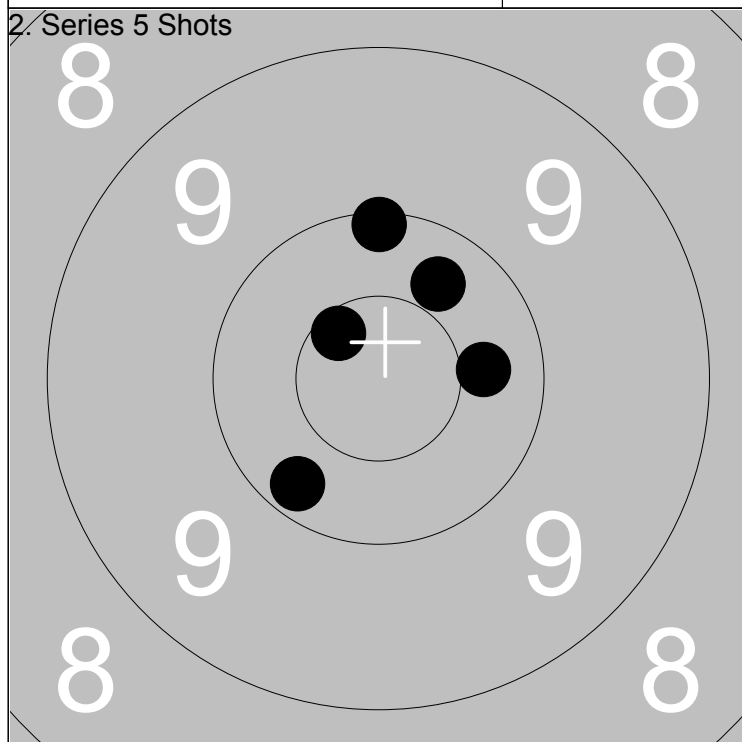

1: 10.1 ↑	Series	50.0
2: 10.2 ↙		
3: 10.4 →	Total	381.0
4: 10.3 ↗		
5: *10.6 ↖		

1: *10.4 ↗	Series	36.0
2: 6.7 ↙		
3: 6.1 ↗	Total	417.0
4: 8.6 ↑		
5: 6.4 ↓		

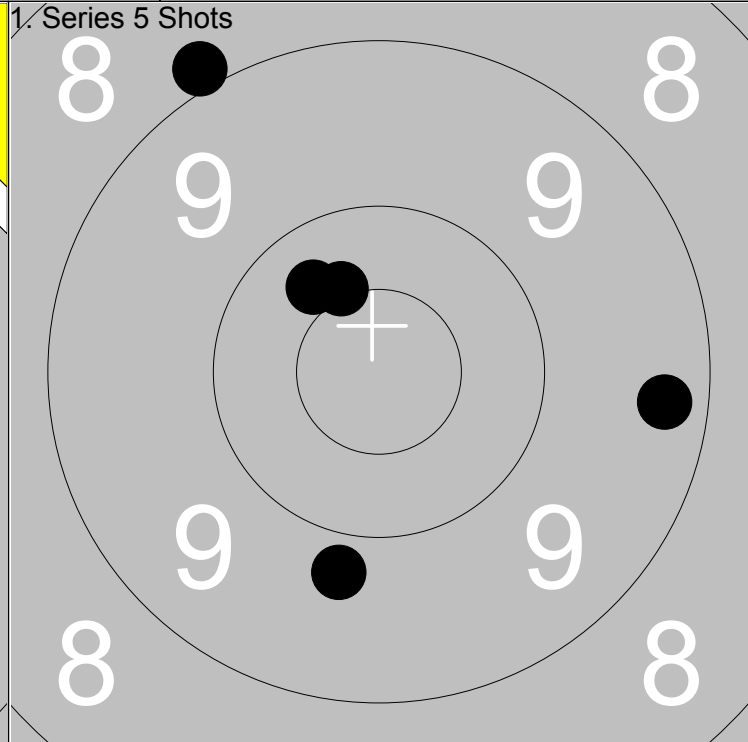
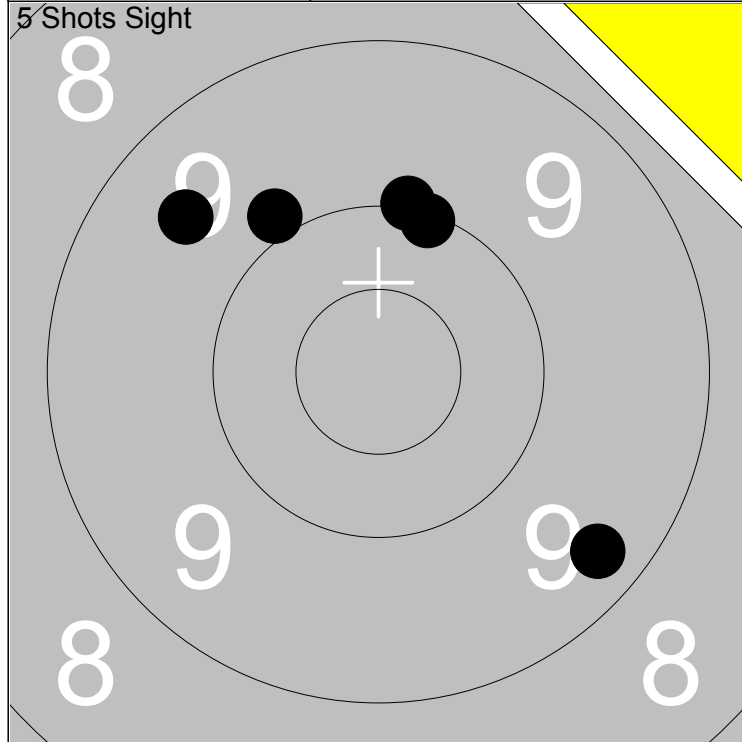

1: 10.0 ↑	Series	47.0
2: 9.5 ↖		
3: 9.3 ↘	Total	278.0
4: 9.9 ↗		
5: 10.1 ↑		

1: 8.9 ↖	Series	46.0
2: 9.8 ↓		
3: 10.3 ↖	Total	324.0
4: 9.3 →		
5: *10.4 ↖		

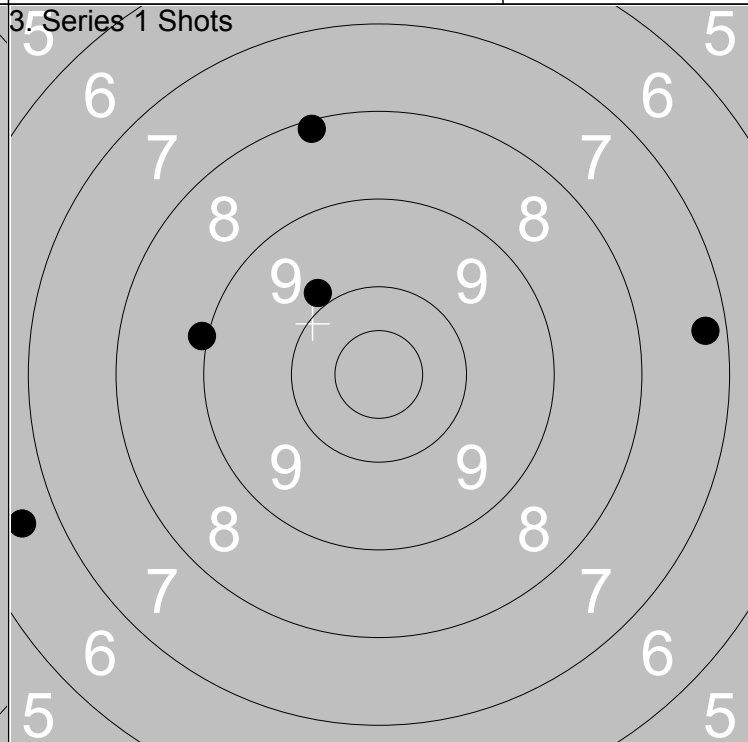
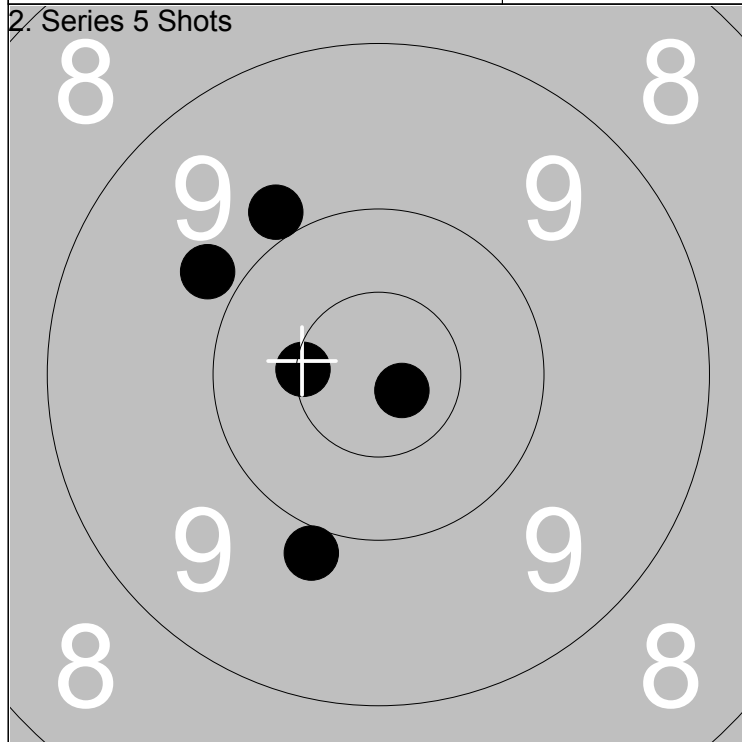

1: 9.9 ↘	Series	47.0
2: 9.9 ↗		
3: *10.5 ←	Total	371.0
4: *10.8 ↘		
5: 9.8 ↖		

1: 9.0 ←	Series	39.0
2: 7.3 →		
3: 6.6 ←	Total	410.0
4: 8.1 ↑		
5: 9.9 ↖		



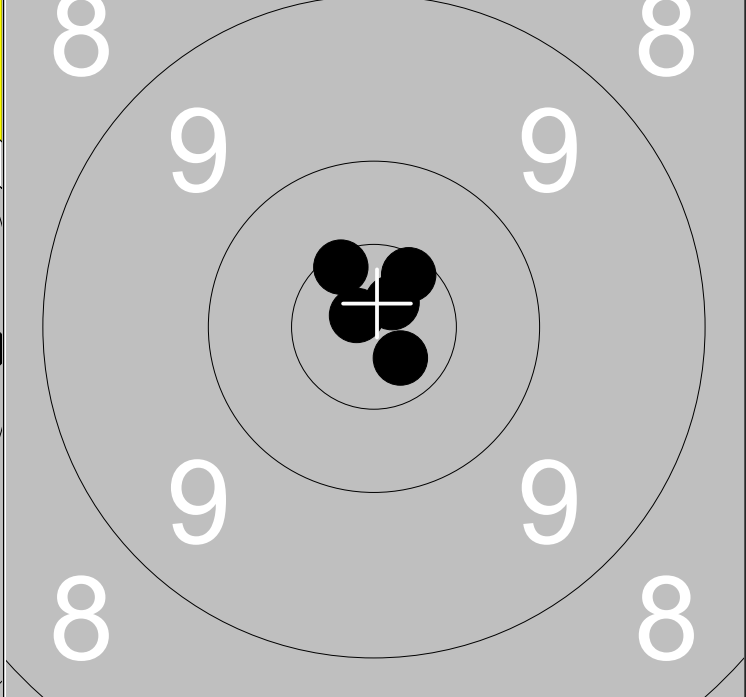
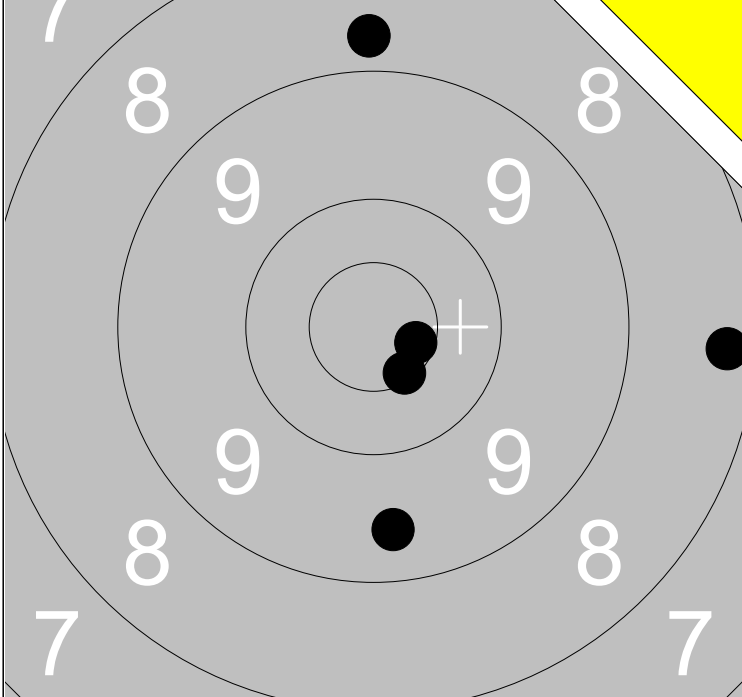

1: 9.4 ↓	Series	45.0
2: *10.6 →		
3: *10.5 ↓	Total	276.0
4: 8.8 ↑		
5: 8.3 →		

1: *10.8 ↗	Series	50.0
2: *10.8 ↖		
3: *10.6 ↖	Total	326.0
4: *10.6 ↗		
5: *10.7 ↓		

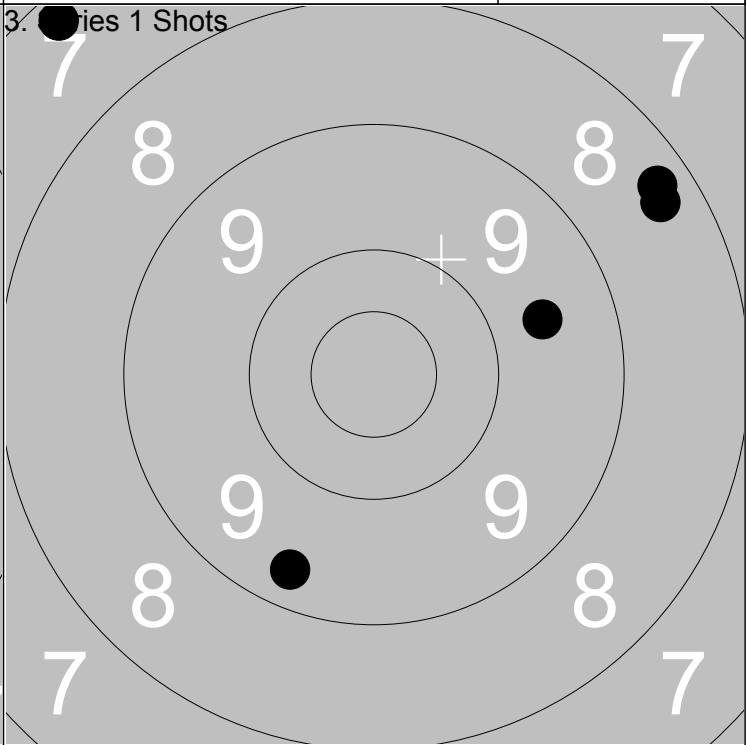
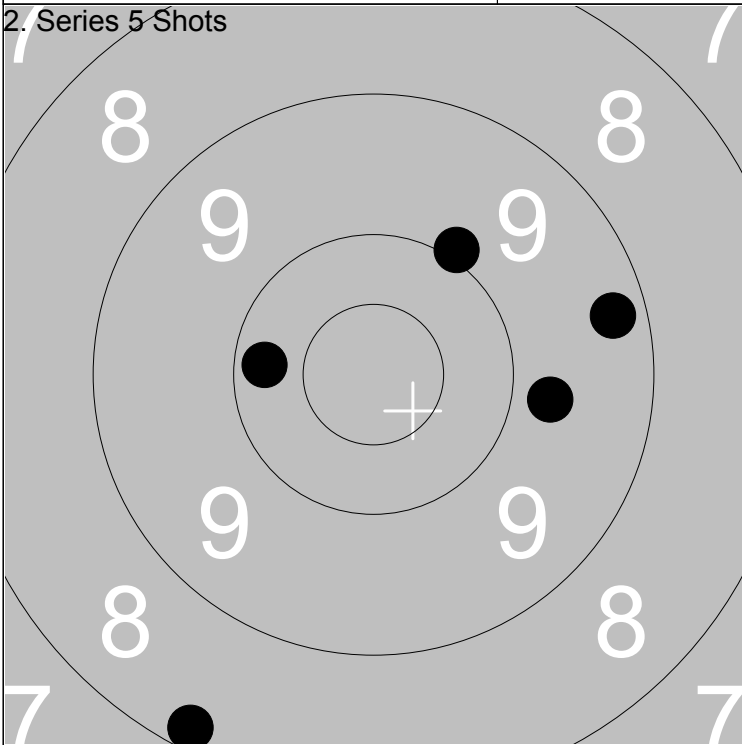

1: 8.2 ↓	Series	46.0
2: 9.3 →		
3: 10.0 ↗	Total	372.0
4: 10.2 ←		
5: 9.8 →		

1: 9.6 →	Series	41.0
2: 8.3 ↗		
3: 7.2 ↖	Total	413.0
4: 8.4 ↗		
5: 9.3 ↓		

Relay <b>5</b>	Lane <b>7</b>	<b>Fanny Storm</b>
-------------------	------------------	--------------------

300m	Loos	7	Gä
------	------	---	----

07.07.2014	Tavelträffen B 2014	Ramselefors SKF
------------	---------------------	-----------------

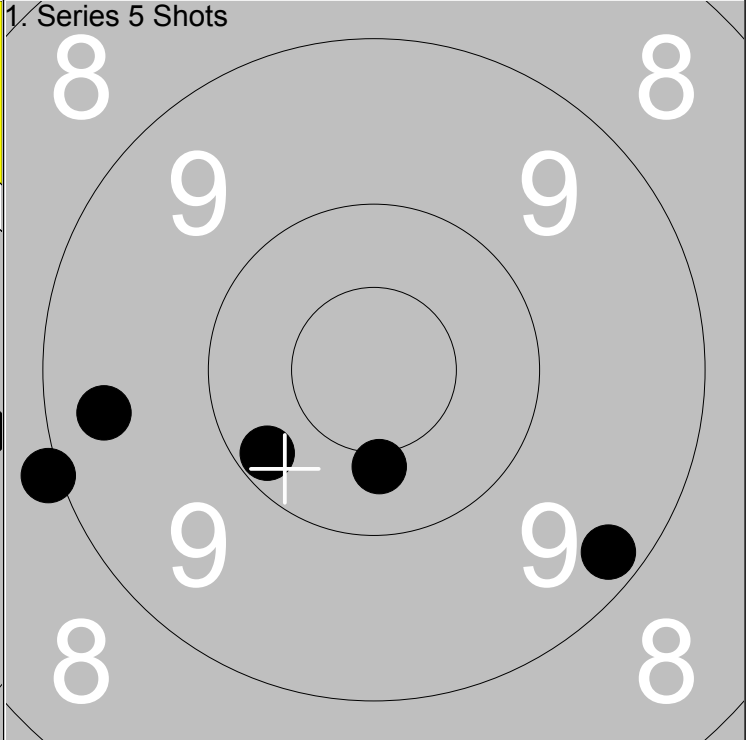
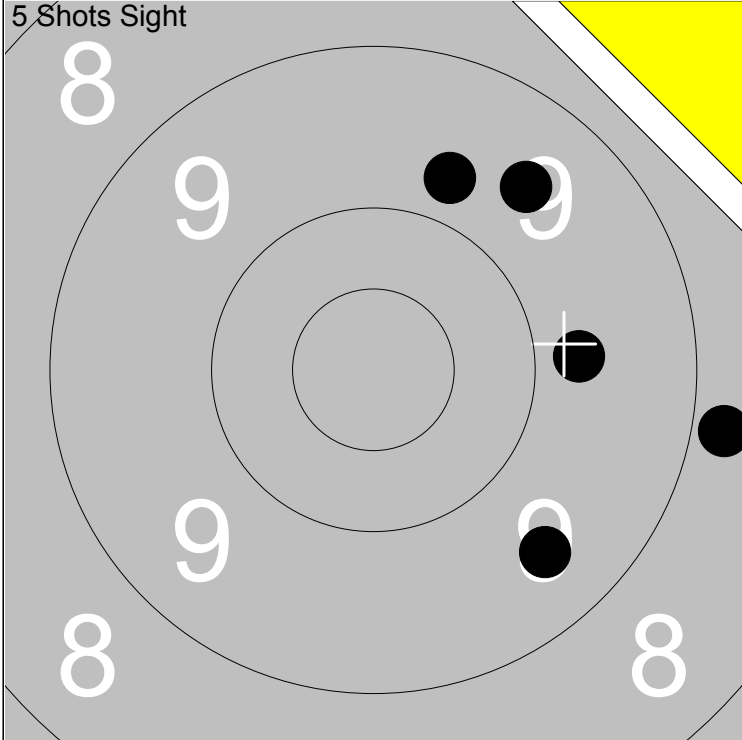

1: 9.5 ↘	Series 44.0
2: 9.8 ↗	
3: 9.6 ↗	Total 274.0
4: 9.8 →	
5: 8.8 →	

1: 9.4 ←	Series 47.0
2: 9.0 ←	
3: 10.2 ↙	Total 321.0
4: 10.4 ↓	
5: 9.2 ↘	

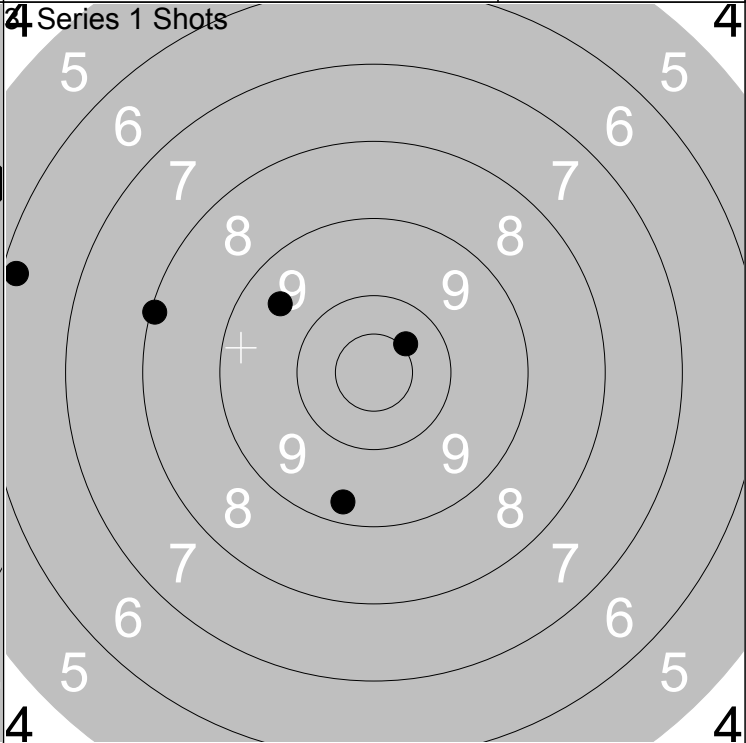
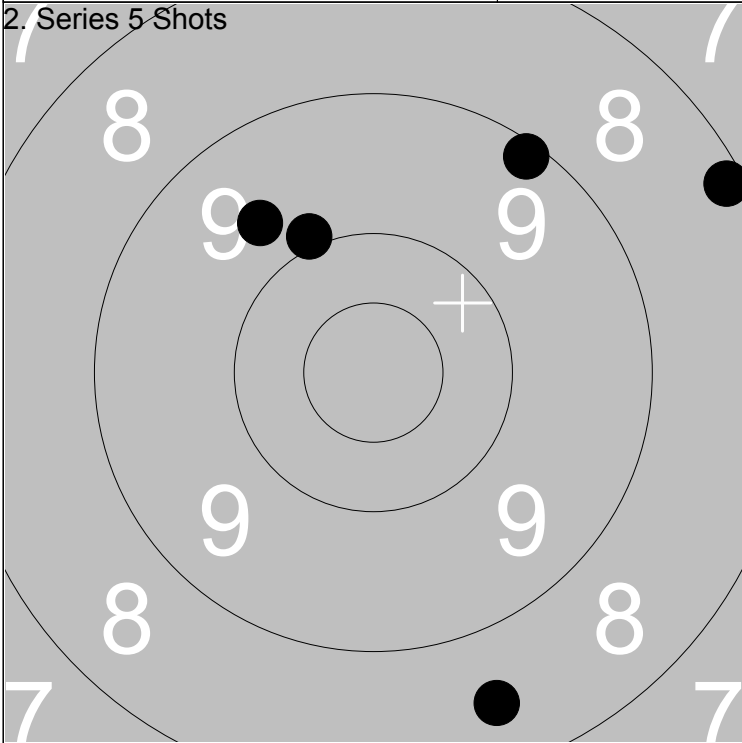

1: 9.9 ↗	Series 43.0
2: 9.7 ↗	
3: 9.1 ↗	Total 364.0
4: 8.2 ↗	
5: 8.5 ↓	

1: 6.2 ←	Series 42.0
2: *10.4 ↗	
3: 9.5 ↖	Total 406.0
4: 9.3 ↓	
5: 8.1 ←	

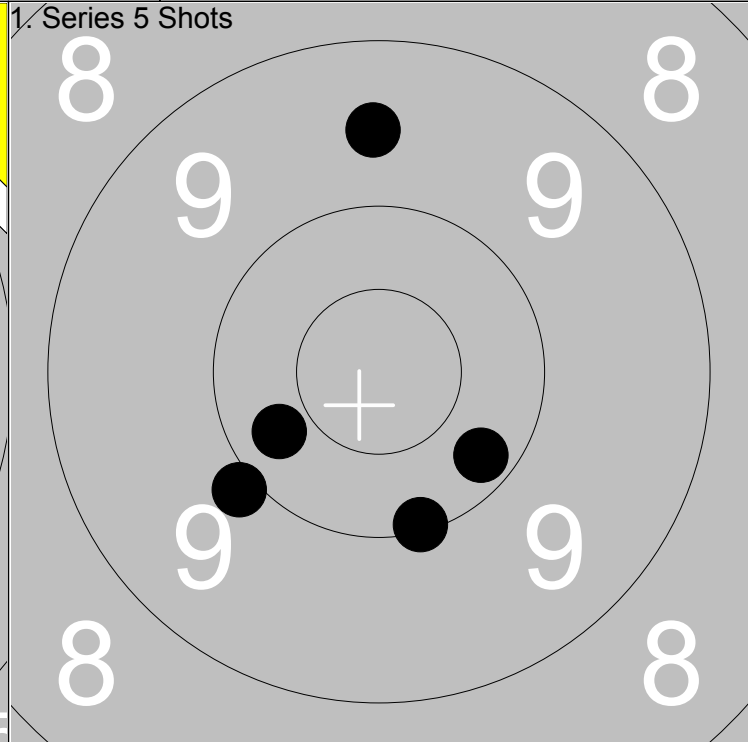
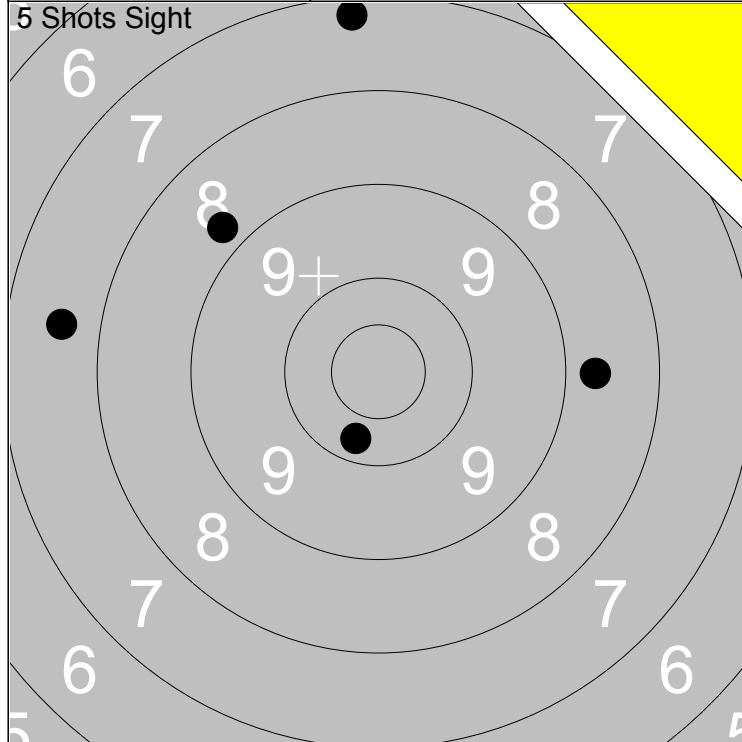

1: 7.2 ↑	Series	40.0
2: 8.8 ↖		
3: 7.6 ←	Total	274.0
4: 8.7 →		
5: 10.3 ↓		

1: 9.6 ↑	Series	48.0
2: 10.3 ↙		
3: 10.1 ↓	Total	322.0
4: 9.9 ↙		
5: 10.2 ↘		

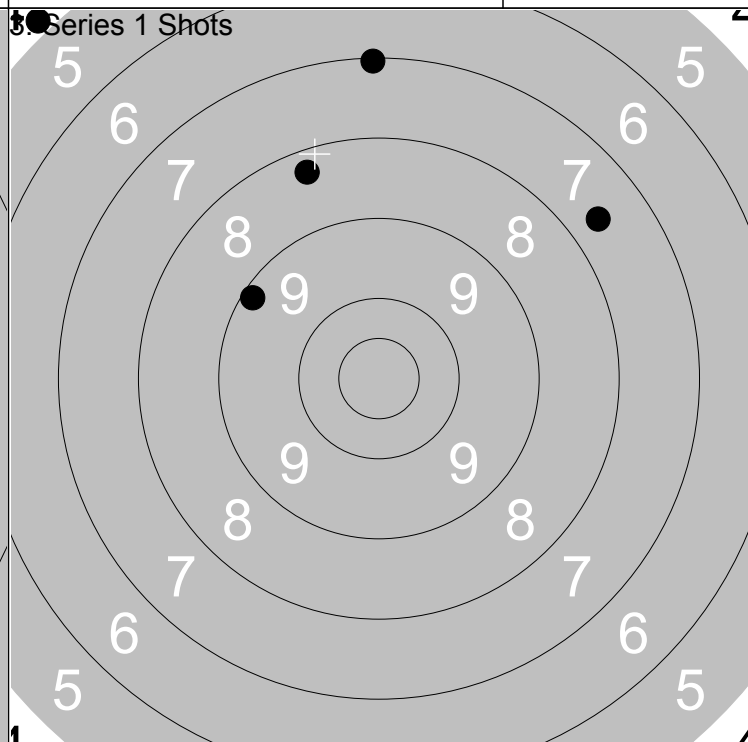
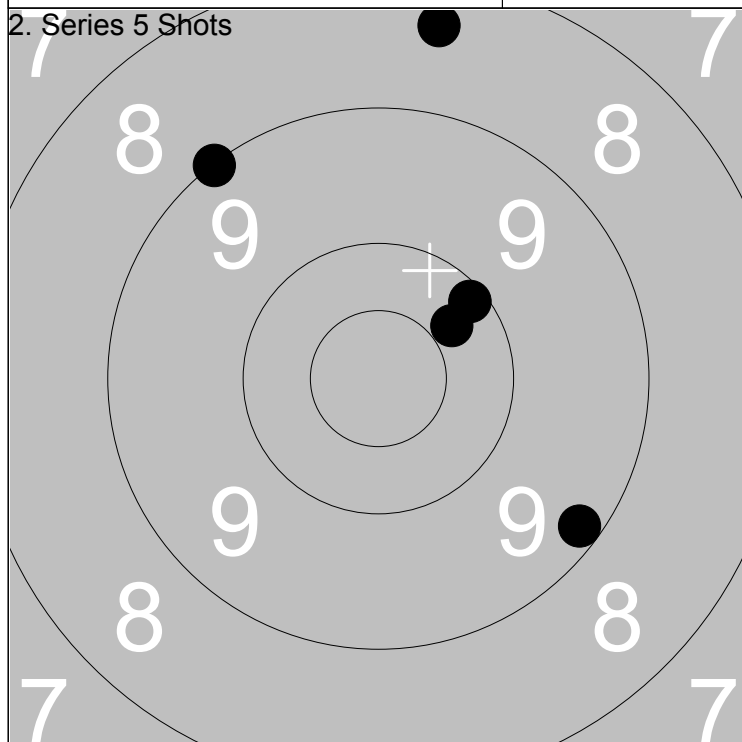

1: 10.1 ↗	Series	46.0
2: 9.2 ↘		
3: 8.4 ↑	Total	368.0
4: 10.3 ↗		
5: 9.0 ↖		

1: 7.1 ↑	Series	35.0
2: 8.3 ↑		
3: 9.2 ↖	Total	403.0
4: 4.9 ↖		
5: 7.6 ↗		

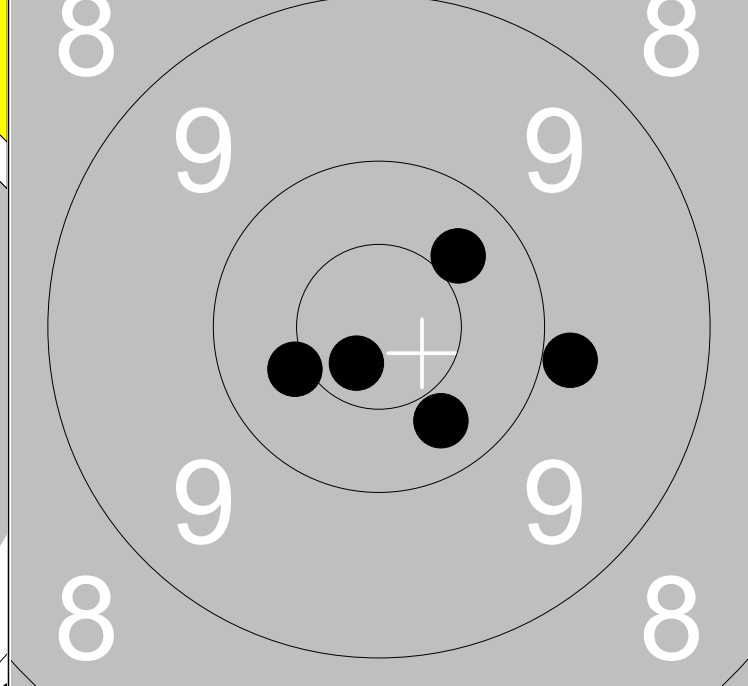
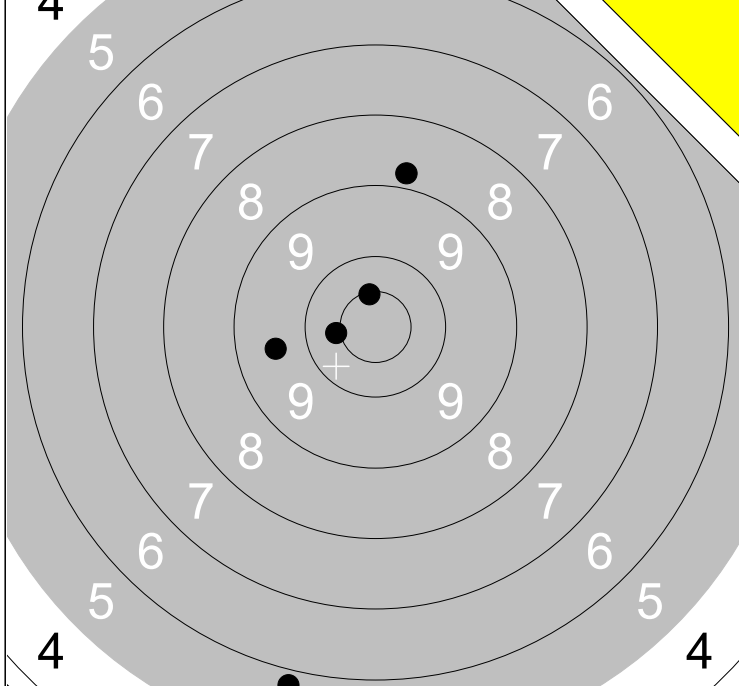

1: *10.5 ↑	Series	42.0	
2: 9.6 ←			
3: *10.4 ←	Total	274.0	
4: 8.8 ↑			
5: 5.8 ↓			

1: *10.4 ↙	Series	49.0	
2: 10.3 ↘			
3: *10.7 ↘	Total	323.0	
4: 10.4 ↗			
5: 9.9 →			

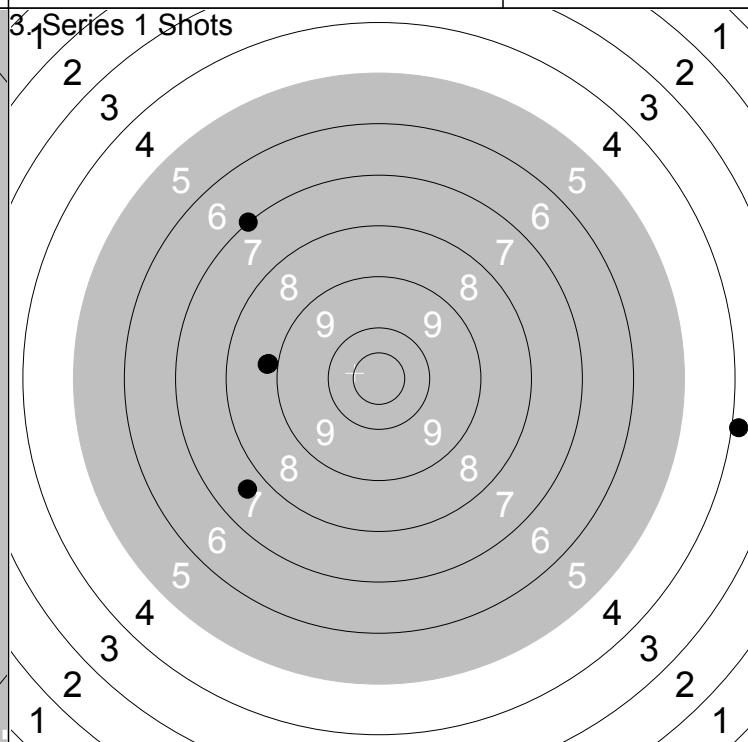
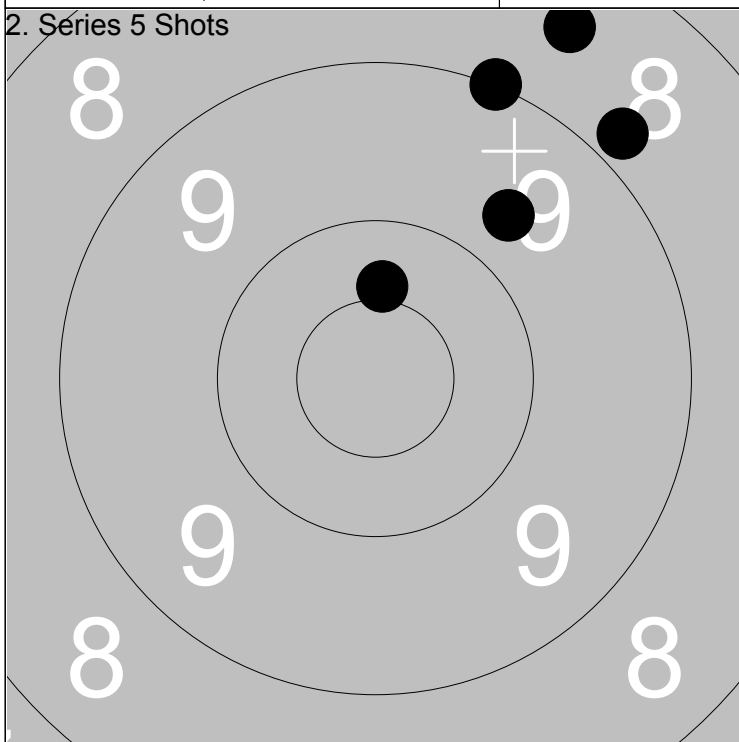

1: 10.4 ↑	Series	44.0	
2: 8.8 ↗			
3: 8.5 ↗	Total	367.0	
4: 9.0 ↑			
5: 9.7 ↗			

1: 7.0 ↖	Series	33.0	
2: 7.7 ↙			
3: 8.8 ←	Total	400.0	
4: 8.8 ←			
5: 3.9 →			

Relay <b>5</b>	Lane <b>11</b>	<b>Alf Edin</b>
-------------------	-------------------	-----------------

300m	Ale	11	No
------	-----	----	----

07.07.2014	Tavelträffen B 2014	Ramselefors SKF
------------	---------------------	-----------------

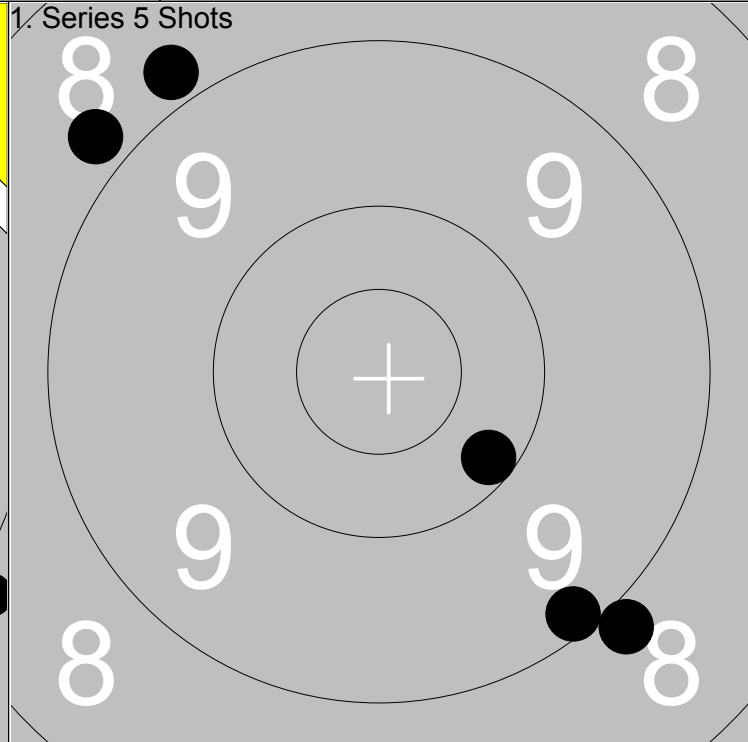
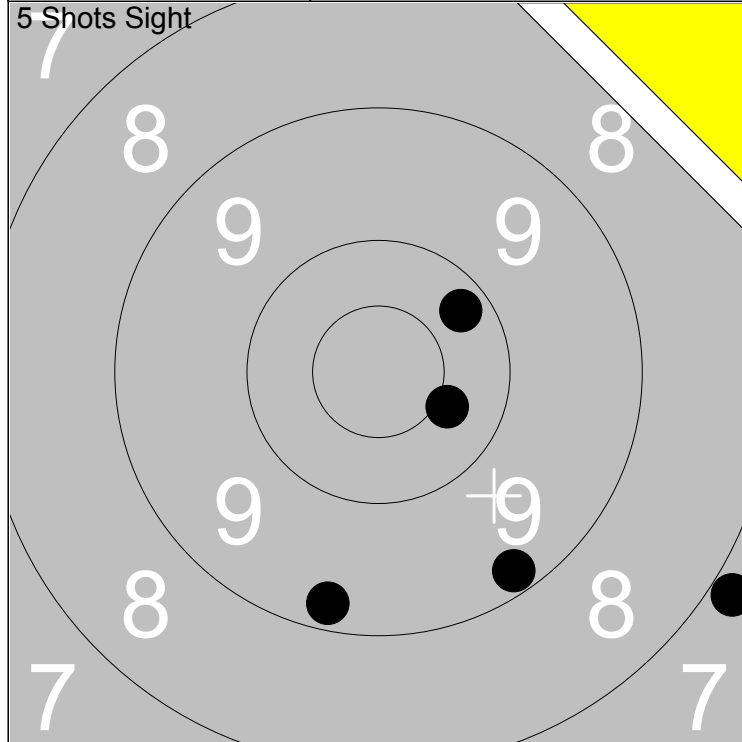

1: 9.2 ↘	Series 45.0
2: 10.2 ↗	
3: 10.4 ↘	Total 273.0
4: 9.2 ↓	
5: 7.9 ↘	

1: 8.8 ↗	Series 43.0
2: 8.8 ↗	
3: 9.2 ↘	Total 316.0
4: 8.9 ↘	
5: 10.2 ↘	

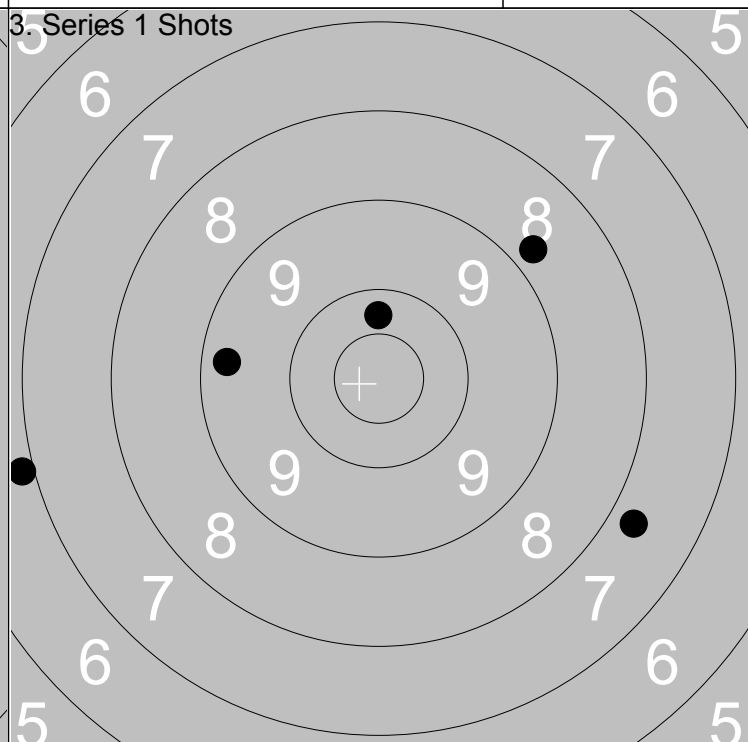
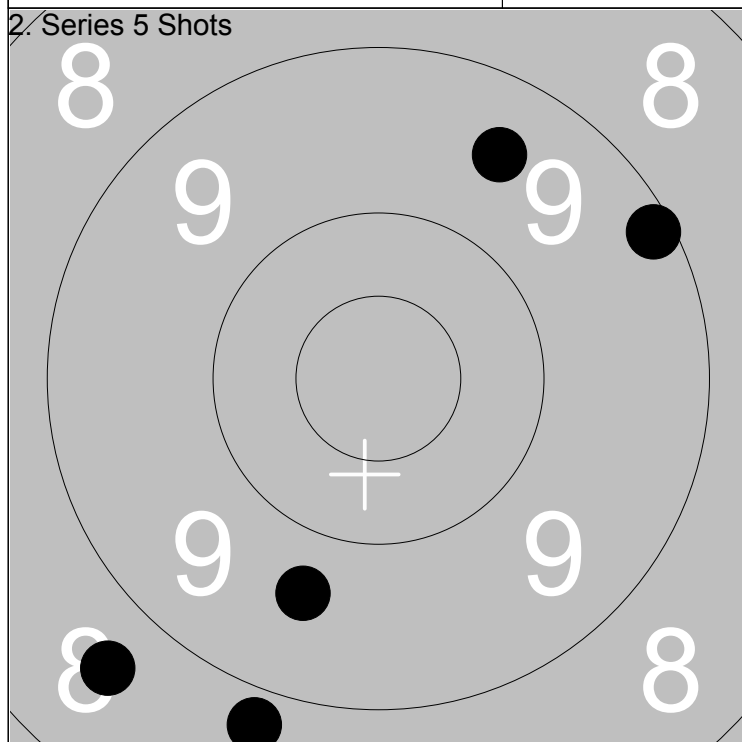

1: 9.5 ↗	Series 43.0
2: 8.8 ↓	
3: 9.1 ↗	Total 359.0
4: 9.7 ↓	
5: 8.6 ↘	

1: 6.9 ←	Series 40.0
2: 8.8 ↗	
3: 9.3 ←	Total 399.0
4: 10.3 ↑	
5: 7.7 ↘	

Relay <b>5</b>	Lane <b>12</b>	<b>Johan Nilsson</b>	
-------------------	-------------------	----------------------	--

300m	Ramselefors	12	Vb
------	-------------	----	----

07.07.2014	Tavelträffen B 2014	Ramselefors SKF	
------------	---------------------	-----------------	--

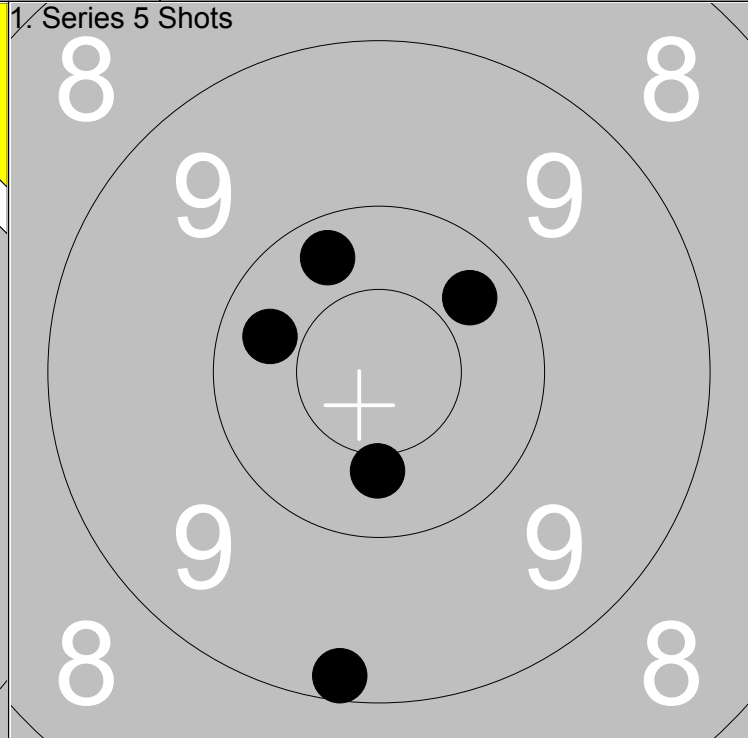
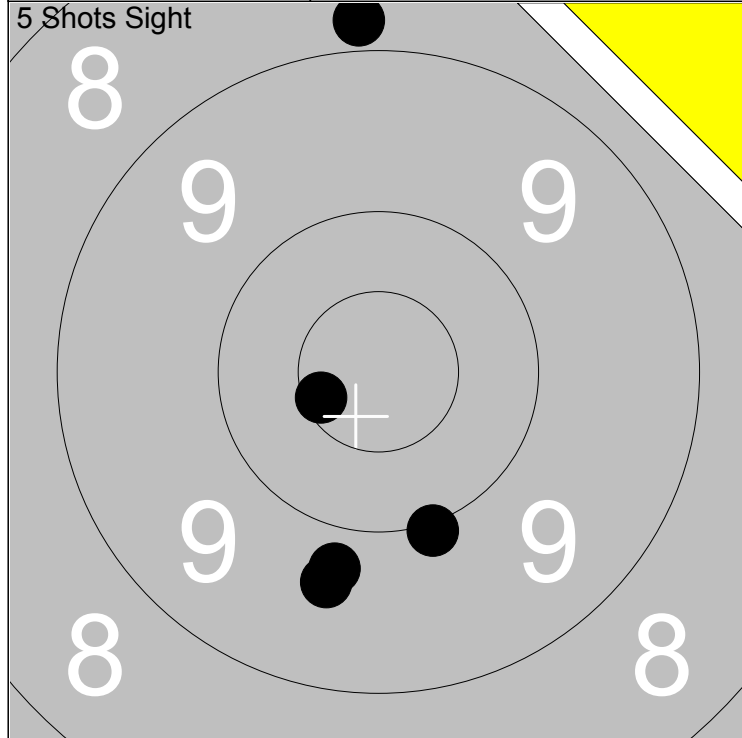

1: *10.6 ↙
2: 9.8 ↓
3: 9.7 ↓
4: 8.8 ↑
5: 10.0 ↓

Series	46.0
Total	272.0

1: 9.2 ↓
2: 10.3 ↗
3: 10.2 ↖
4: 10.3 ↙
5: 10.4 ↓

Series	49.0
Total	321.0

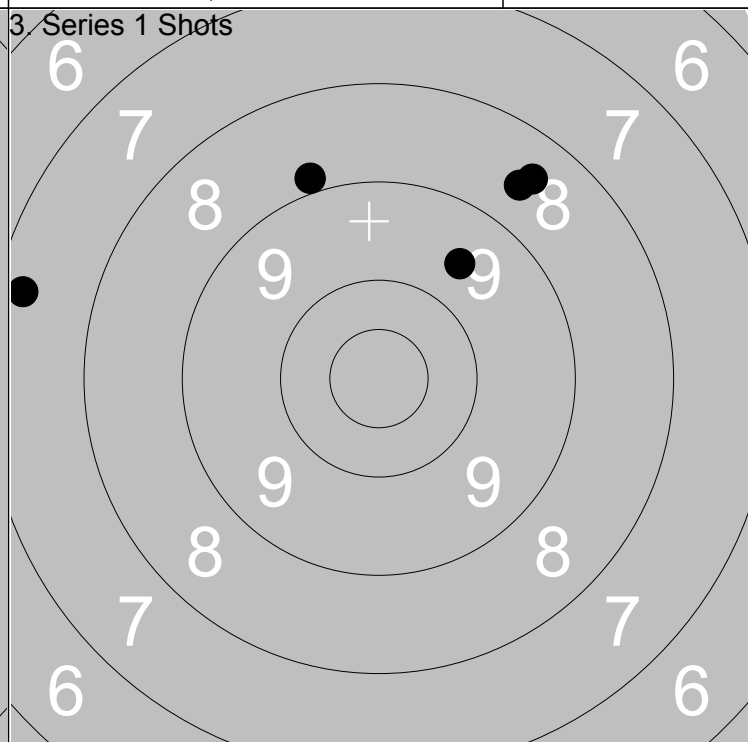
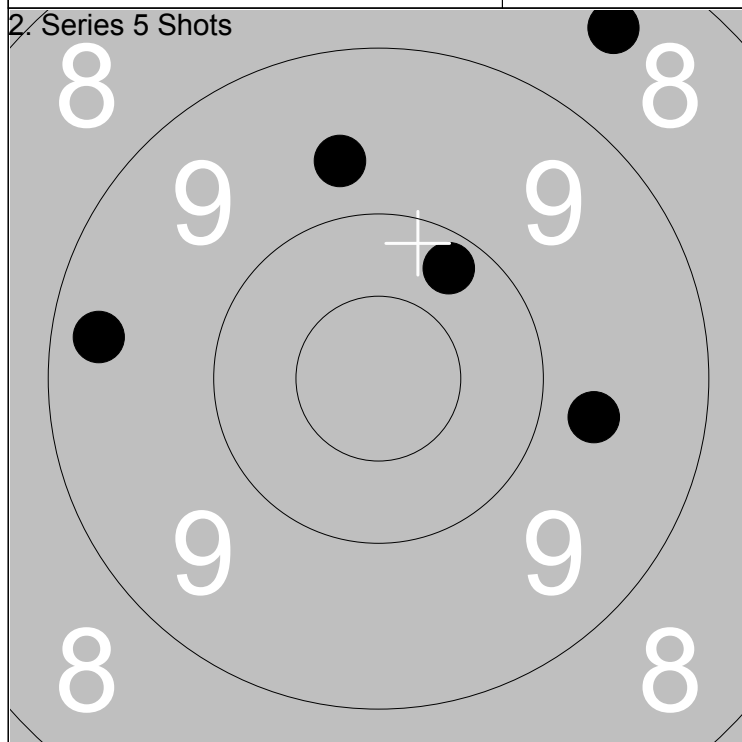

1: 9.7 ↑
2: 8.5 ↗
3: 9.3 ←
4: 10.2 ↗
5: 9.7 →

Series	45.0
Total	366.0

1: 8.6 ↗
2: 8.5 ↗
3: 8.9 ↖
4: 7.3 ←
5: 9.6 ↗

Series	40.0
Total	406.0

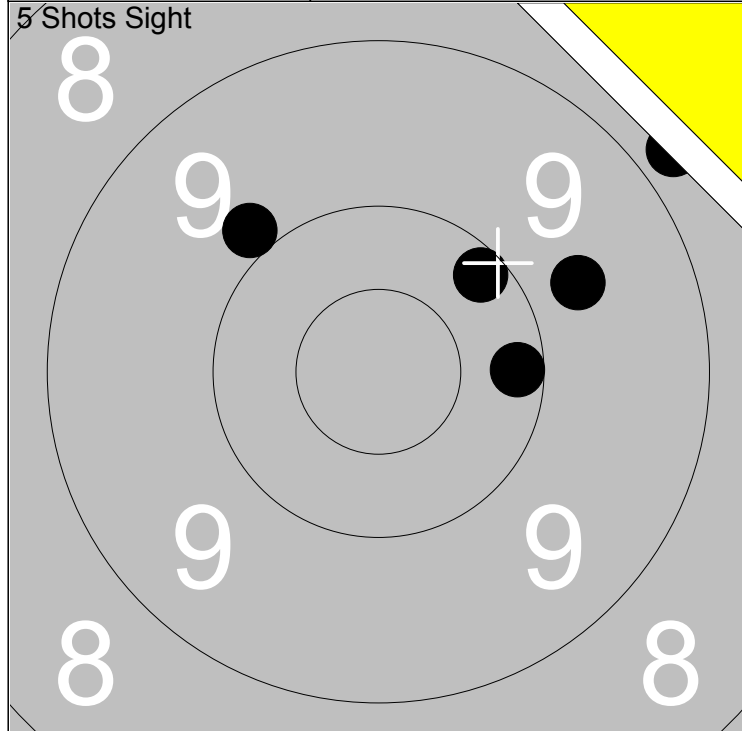

1: 10.2 ↗
2: 9.9 ↖
3: 9.7 →
4: 8.8 ↗
5: 10.2 →

Series	46.0
Total	271.0

1: *10.7 ↓
2: 10.3 ↓
3: 10.0 →
4: 10.3 ↖
5: 10.2 ↓

Series	50.0
Total	321.0

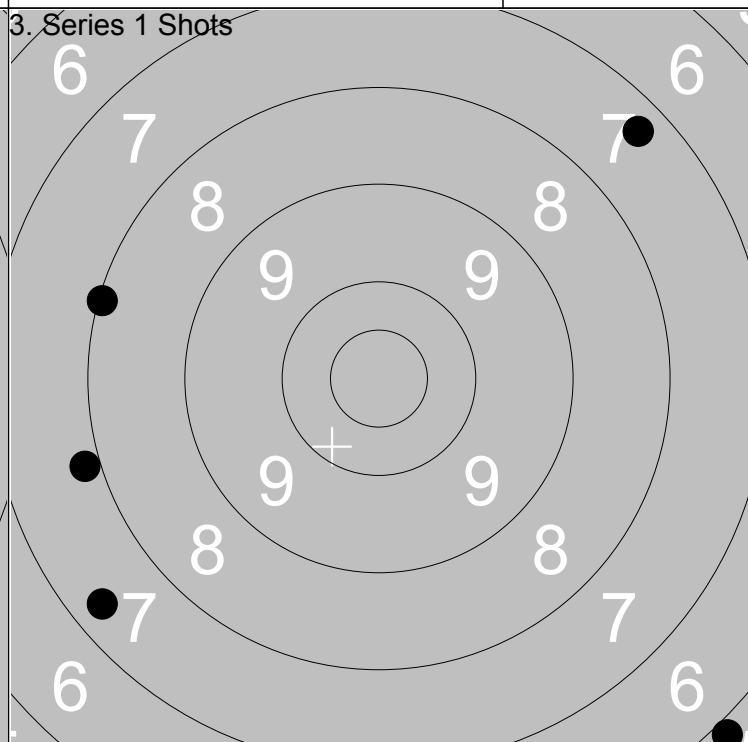
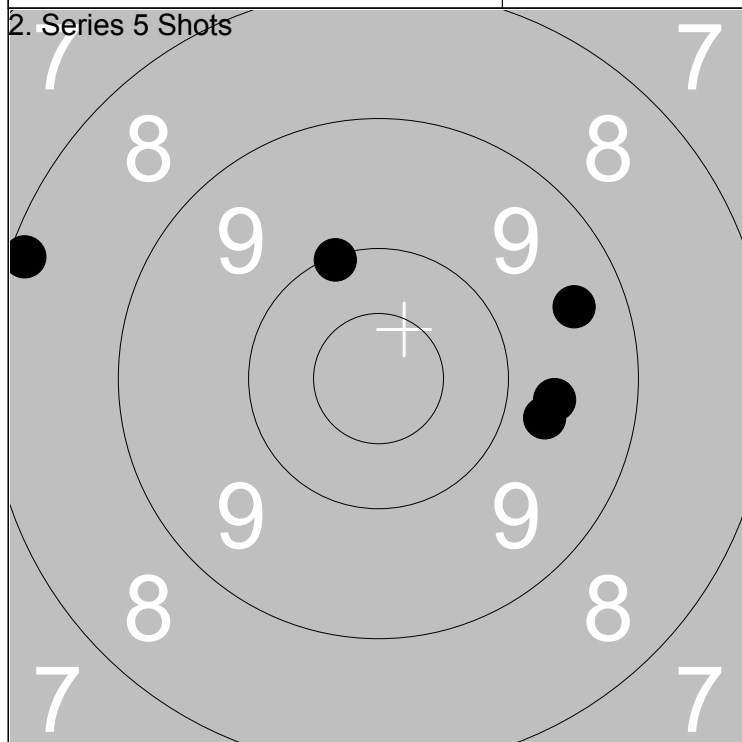

1: 10.1 ↑
2: 9.7 →
3: 9.4 →
4: 9.7 →
5: 8.2 ↖

Series	45.0
Total	366.0

1: 7.9 ↖
2: 7.4 ↙
3: 7.3 ↗
4: 8.1 ↖
5: 5.9 ↓

Series	34.0
Total	400.0

Relay <b>5</b>	Lane <b>14</b>	<b>Stefan Jonasson</b>
-------------------	-------------------	------------------------

300m	Hogdal	14	Jä
------	--------	----	----

07.07.2014	Tavelträffen B 2014	Ramselefors SKF
------------	---------------------	-----------------

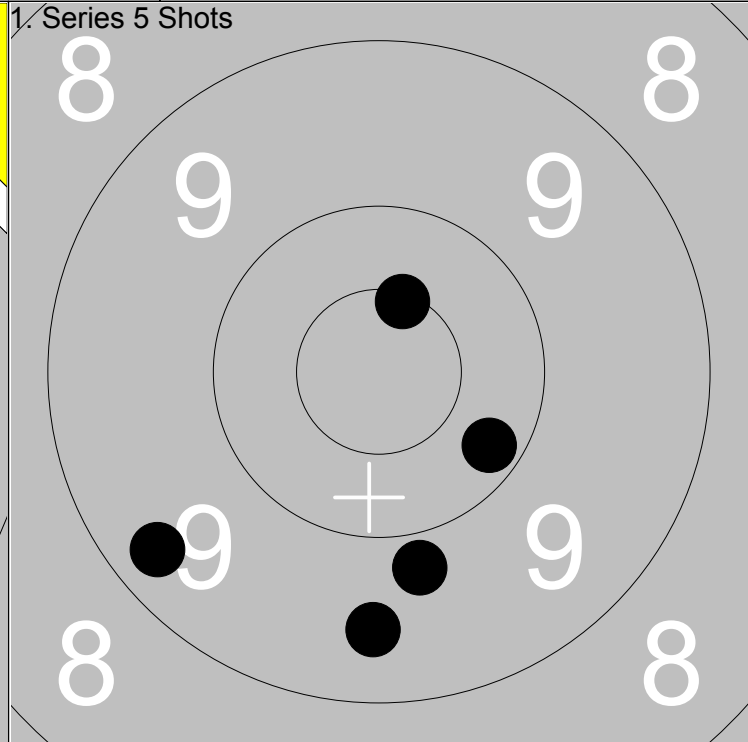
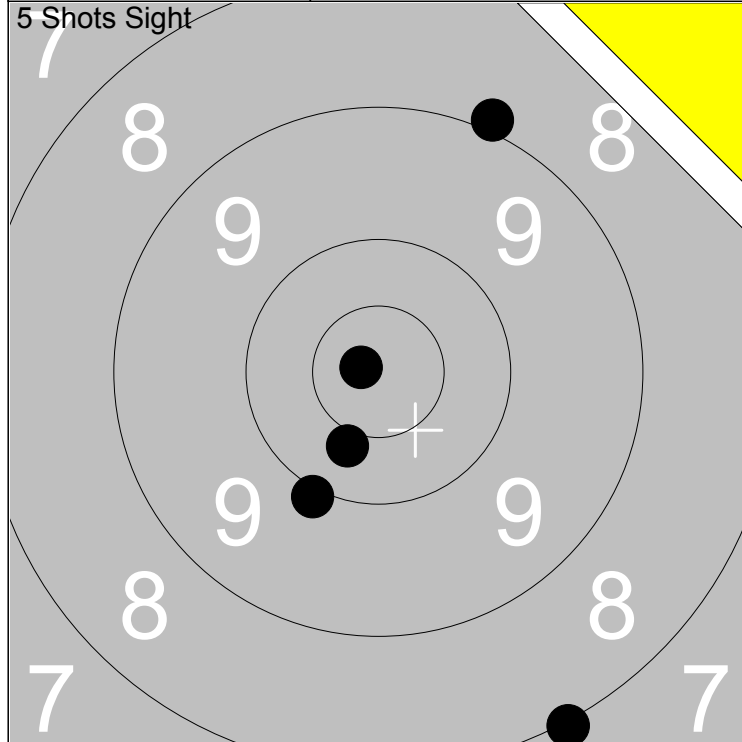

1: 8.0 ↘	Series	46.0
2: 10.0 ↘		
3: 10.4 ↘	Total	269.0
4: *10.8 ↙		
5: 8.9 ↗		

1: *10.5 ↗	Series	47.0
2: 10.2 ↘		
3: 9.3 ↙	Total	316.0
4: 9.5 ↓		
5: 9.8 ↓		

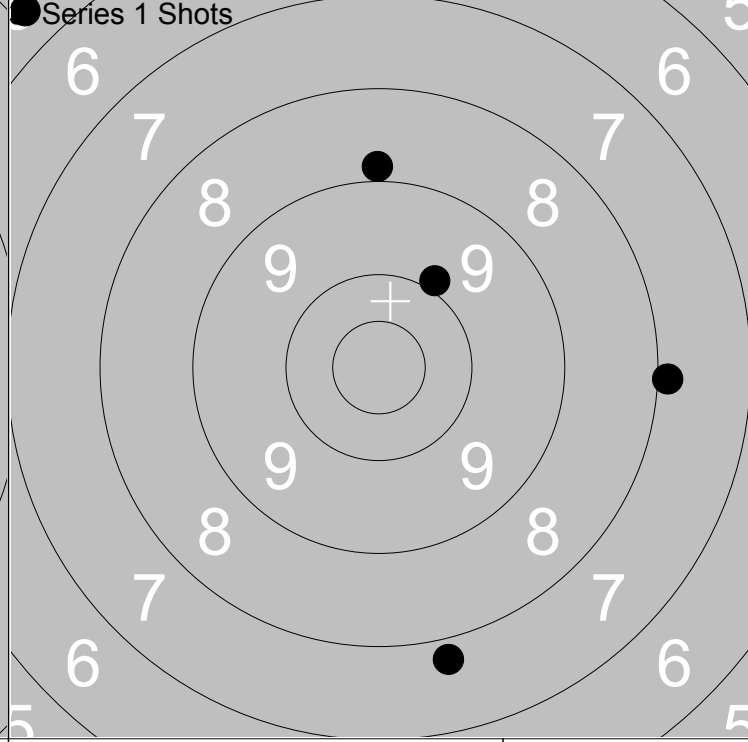
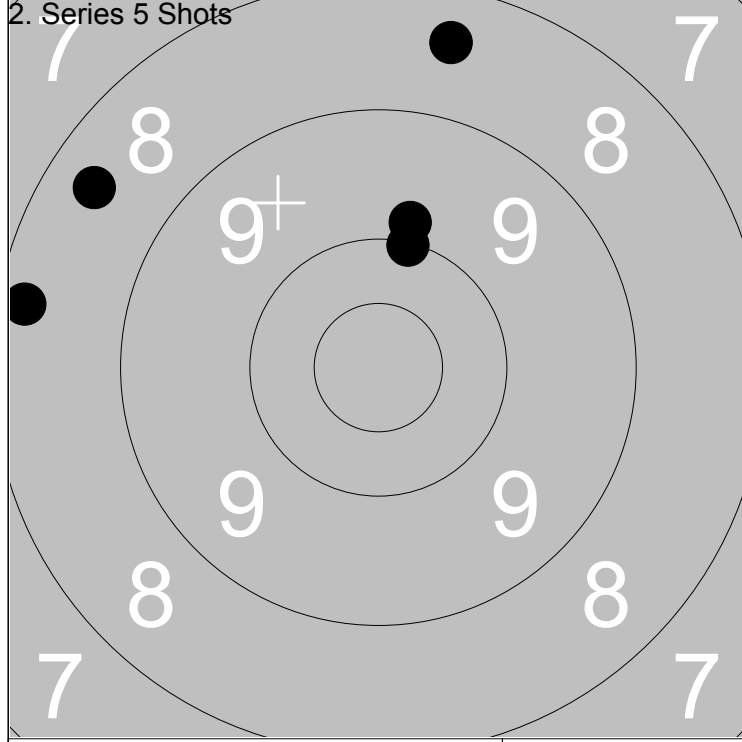

1: 10.0 ↗	Series	43.0
2: 9.9 ↗		
3: 8.4 ↗	Total	359.0
4: 8.4 ↙		
5: 8.2 ↙		

1: 8.9 ↗	Series	36.0
2: 9.9 ↗		
3: 5.6 ↙	Total	395.0
4: 7.9 →		
5: 7.8 ↓		



Relay <b>5</b>	Lane <b>15</b>	<b>Linda Bergman</b>
-------------------	-------------------	----------------------

300m	Ununge	15	St
------	--------	----	----

07.07.2014	Tavelträffen B 2014	Ramselefors SKF
------------	---------------------	-----------------

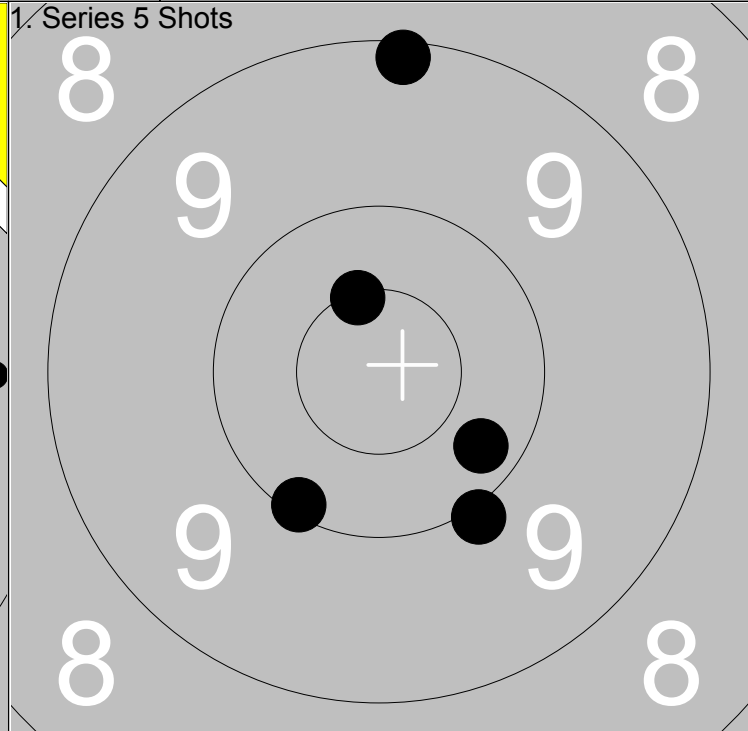
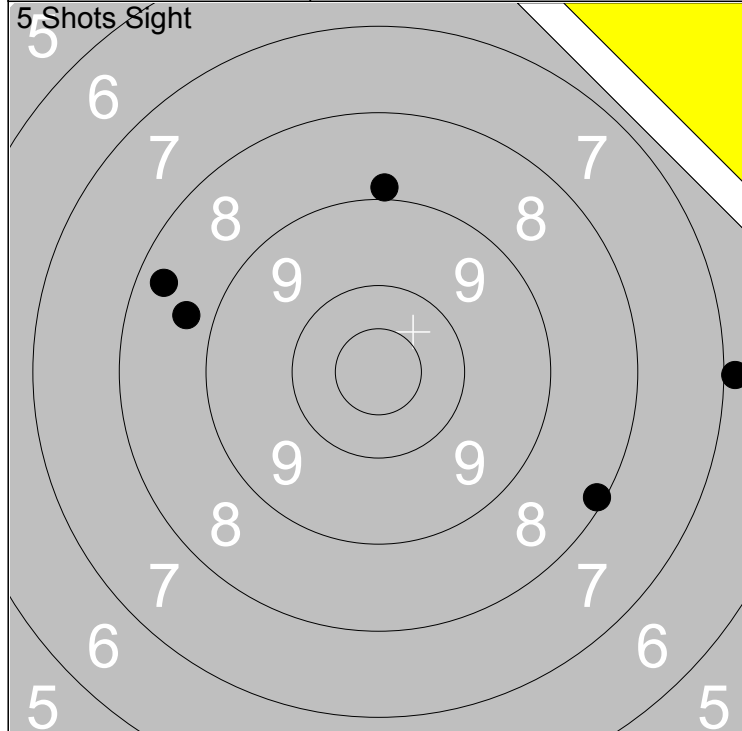

1: 8.7 ←
2: 8.3 ↙
3: 8.9 ↑
4: 6.9 →
5: 8.1 ↘

Series	38.0
Total	268.0

1: 9.1 ↑
2: *10.5 ↗
3: 10.1 ↘
4: 10.2 ↘
5: 10.0 ↘

Series	49.0
Total	317.0

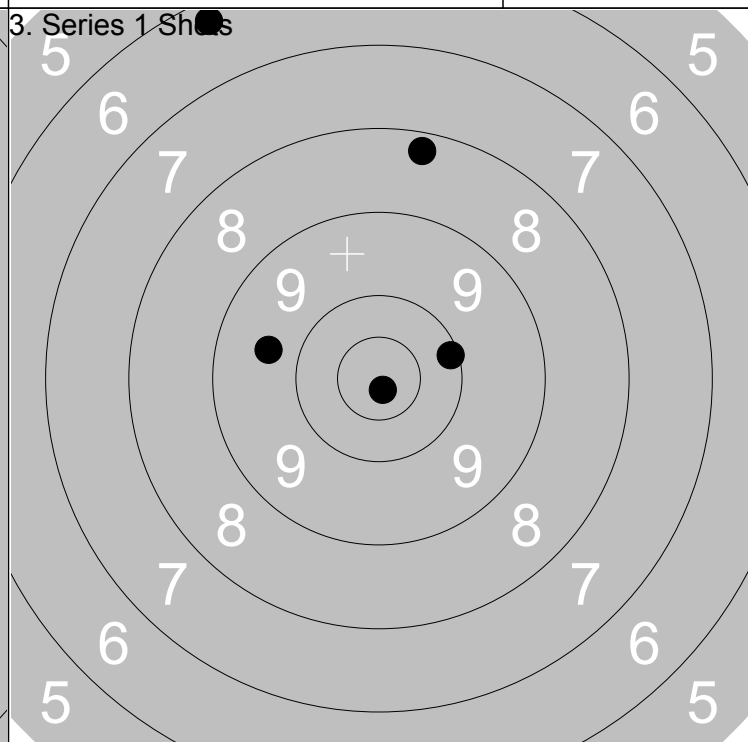
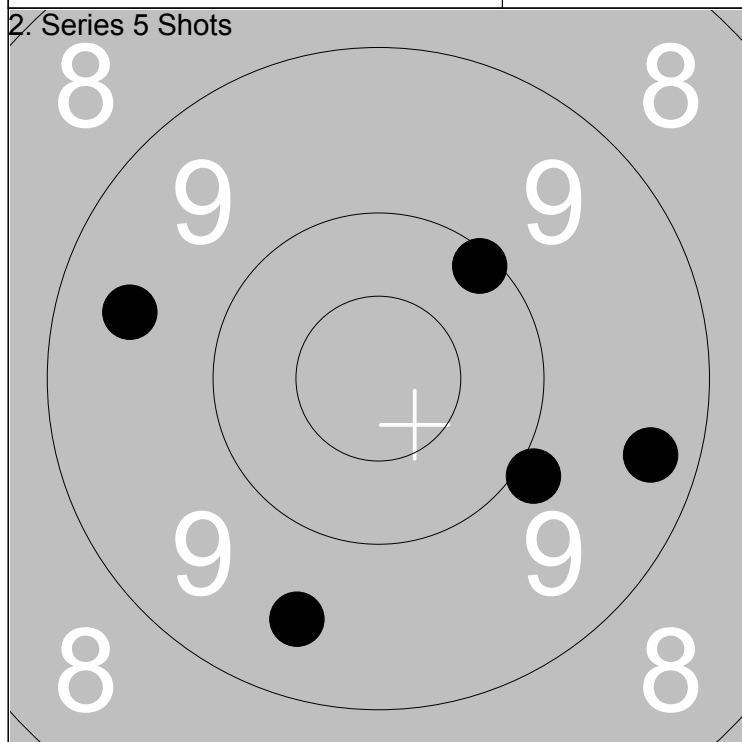

1: 9.5 ↘
2: 10.1 ↗
3: 9.9 ↘
4: 9.3 →
5: 9.5 ←

Series	46.0
Total	363.0

1: 10.1 →
2: 8.2 ↑
3: *10.8 ↘
4: 6.3 ↗
5: 9.7 ←

Series	43.0
Total	406.0

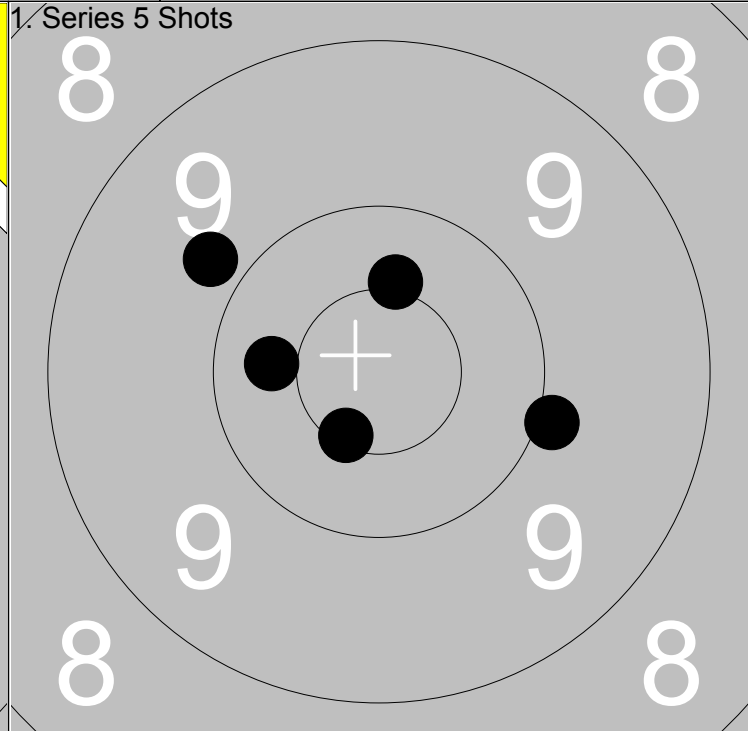
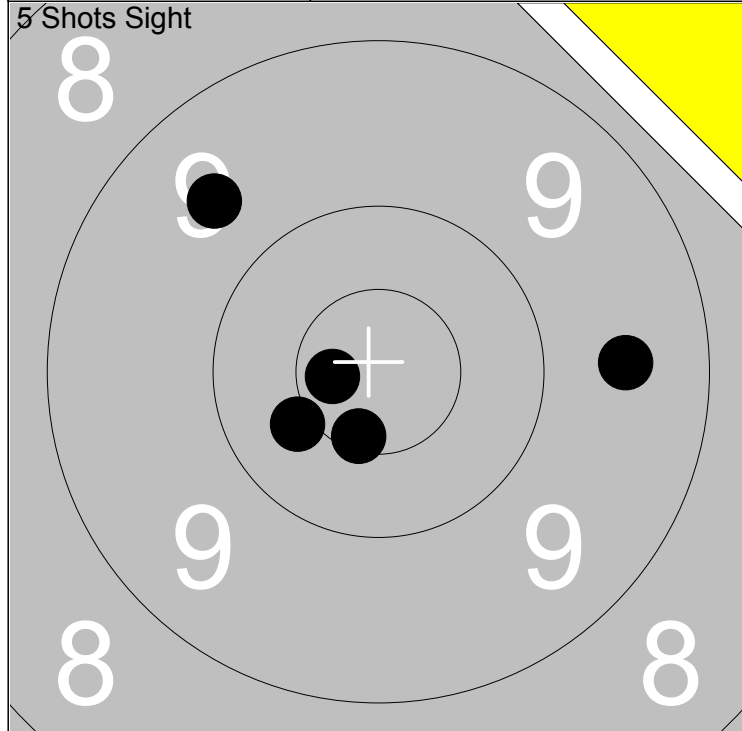

1: 9.6 ↖	Series	48.0
2: 10.4 ↙		
3: 9.5 →	Total	268.0
4: *10.7 ↙		
5: *10.6 ↘		

1: 9.9 →	Series	48.0
2: 10.3 ←		
3: *10.4 ↑	Total	316.0
4: *10.6 ↘		
5: 9.8 ↖		

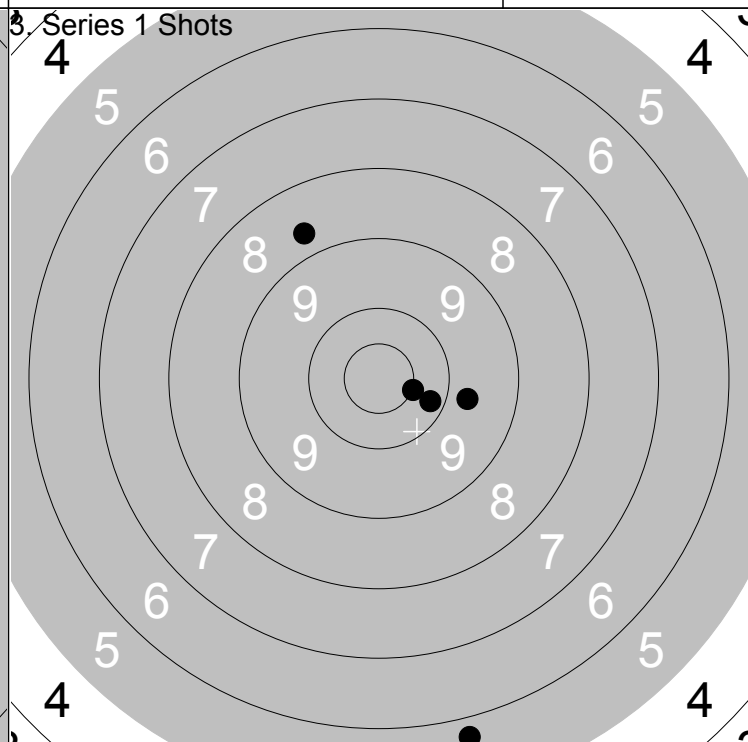
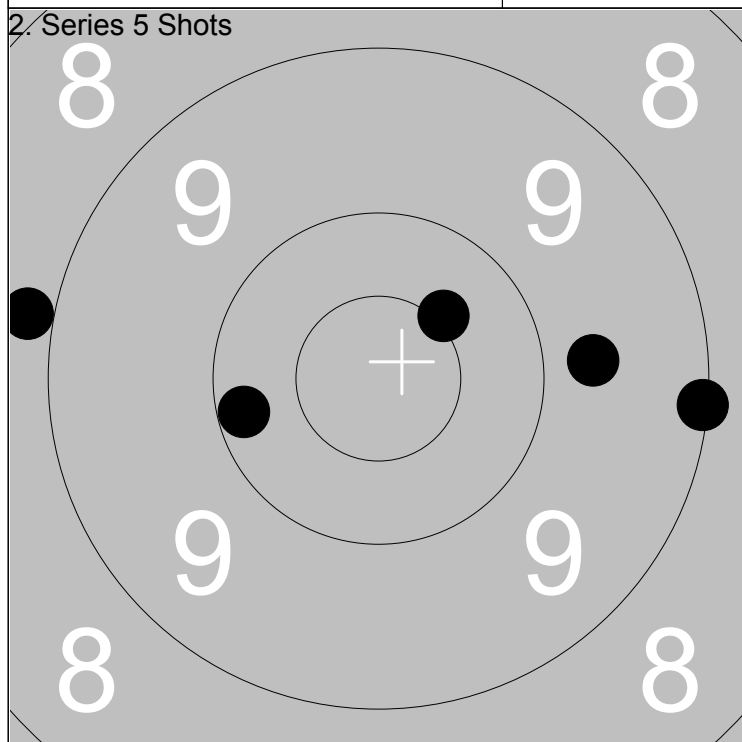

1: 10.2 ←	Series	46.0
2: 8.9 ←		
3: 9.7 →	Total	362.0
4: *10.4 ↗		
5: 9.1 →		

1: 5.7 ↘	Series	42.0
2: 8.7 ↗		
3: 10.2 →	Total	404.0
4: *10.5 →		
5: 9.7 →		

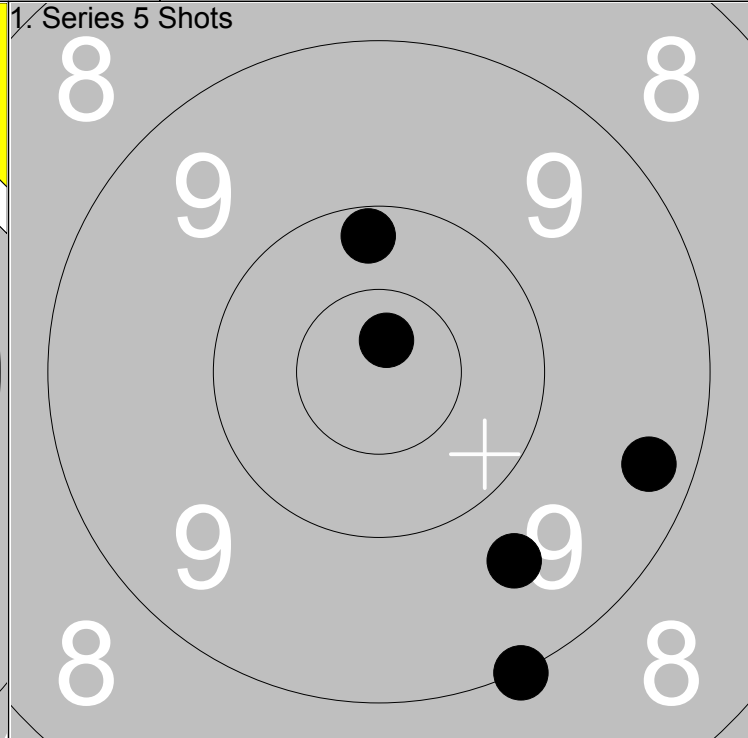
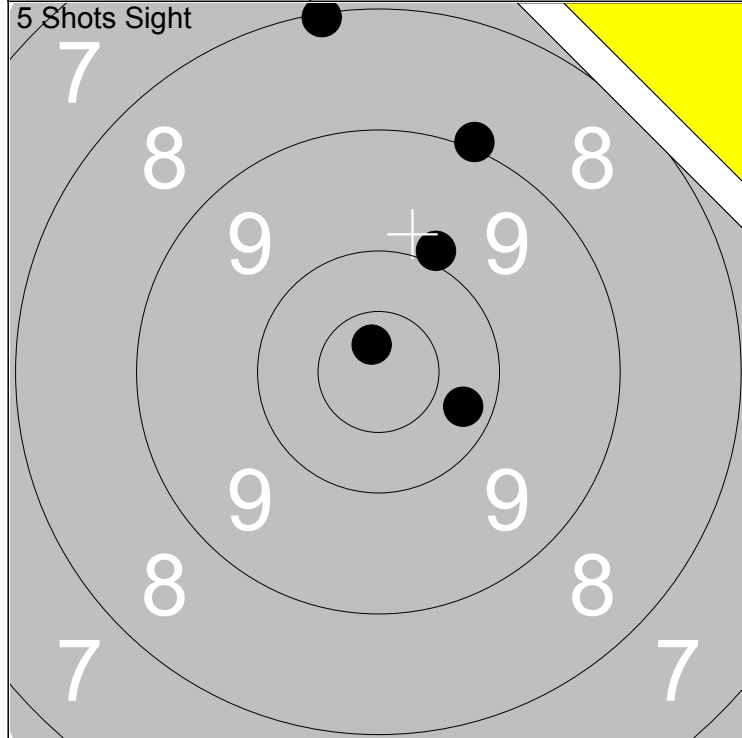

1: *10.7↑	Series	46.0
2: 10.2 →		
3: 9.9 ↗	Total	267.0
4: 9.0 ↗		
5: 8.1 ↑		

1: 9.6 ↓	Series	47.0
2: *10.8↑		
3: 10.2 ↑	Total	314.0
4: 9.0 ↓		
5: 9.3 →		

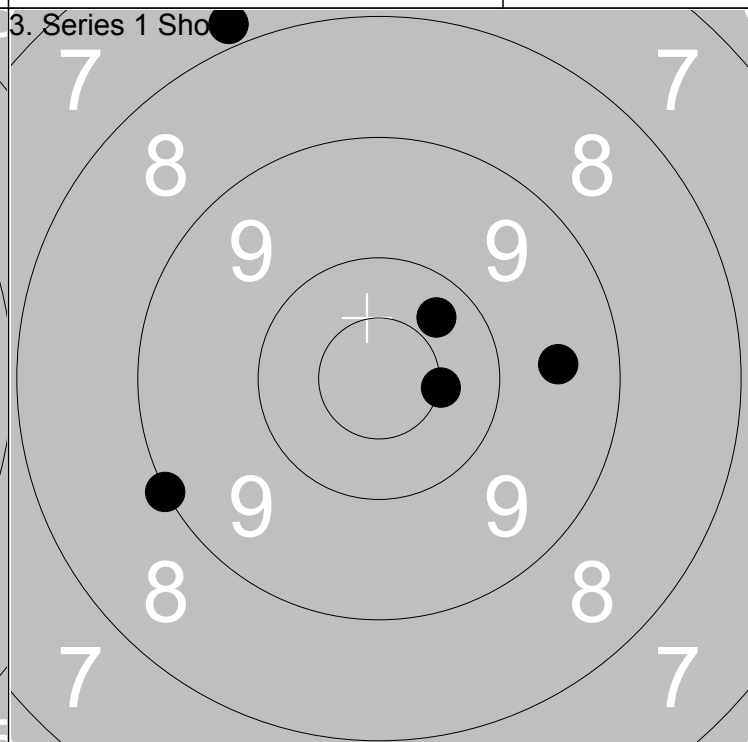
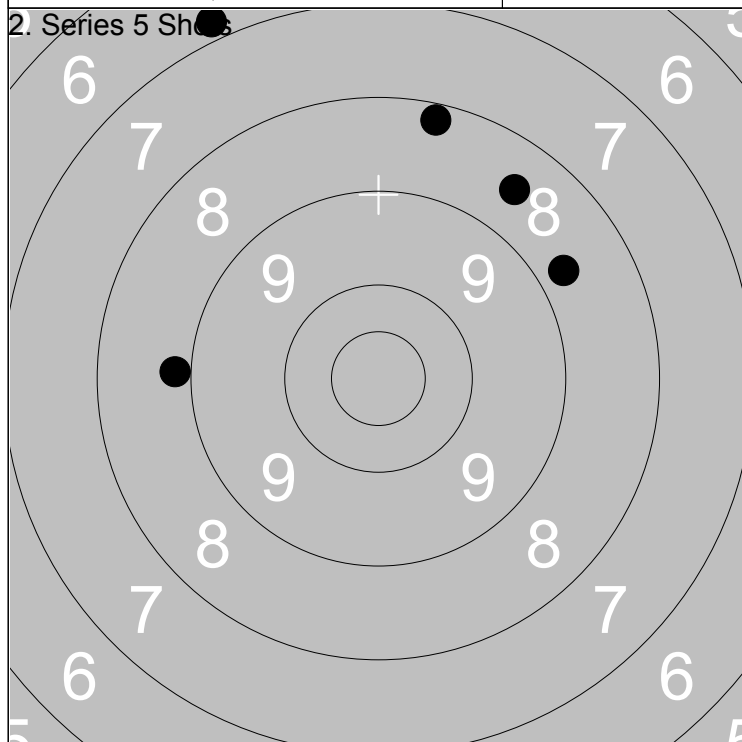

1: 8.9 ←	Series	38.0
2: 6.8 ↗		
3: 8.2 ↑	Total	352.0
4: 8.5 ↗		
5: 8.7 ↗		

1: 10.3 ↗	Series	45.0
2: 7.8 ↗		
3: *10.5 →	Total	397.0
4: 9.0 ←		
5: 9.5 →		

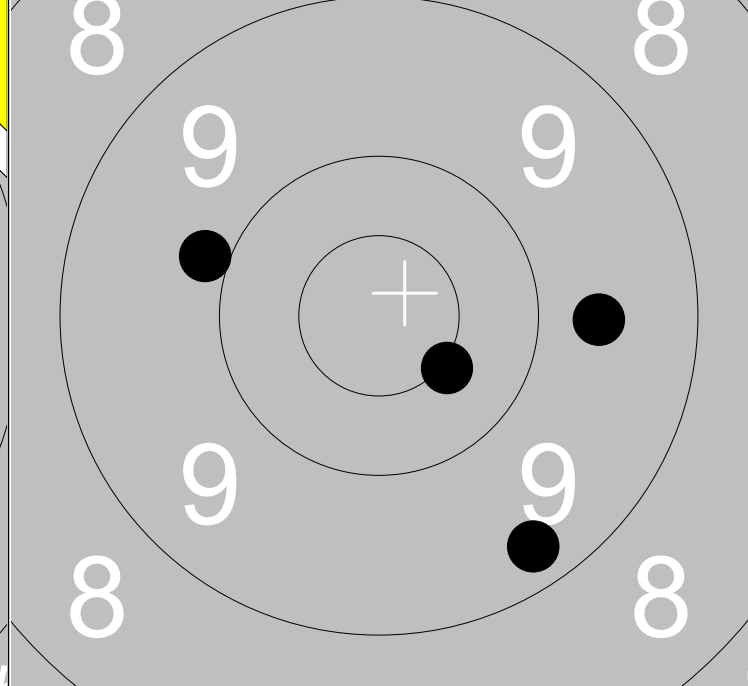
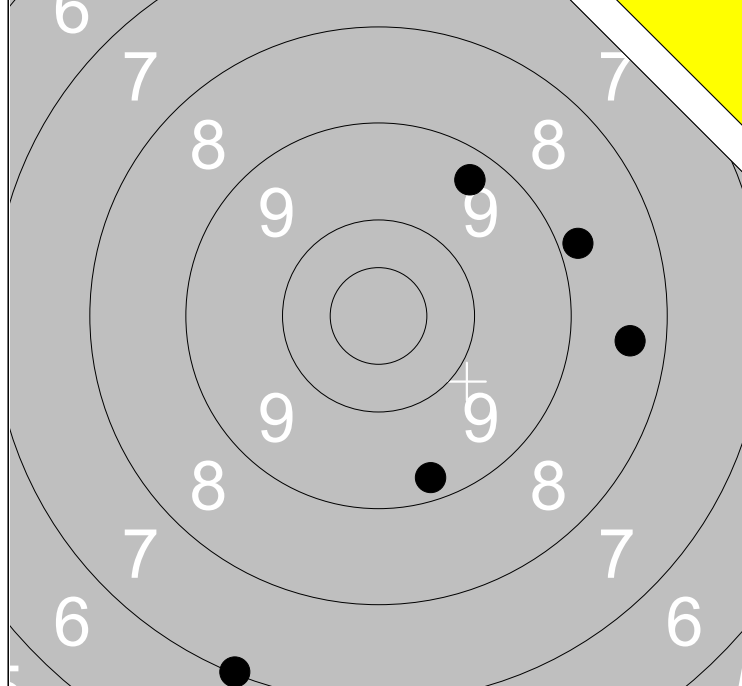

1: 8.4 →	Series    41.0
2: 9.3 ↓	
3: 9.3 ↗	
4: 8.8 →	
5: 7.0 ↓	
Total    257.0	

1: 9.9 ←	Series    45.0
2: 9.6 →	
3: *10.5 ↘	
4: 9.3 ↓	
5: 8.7 ↗	
Total    302.0	

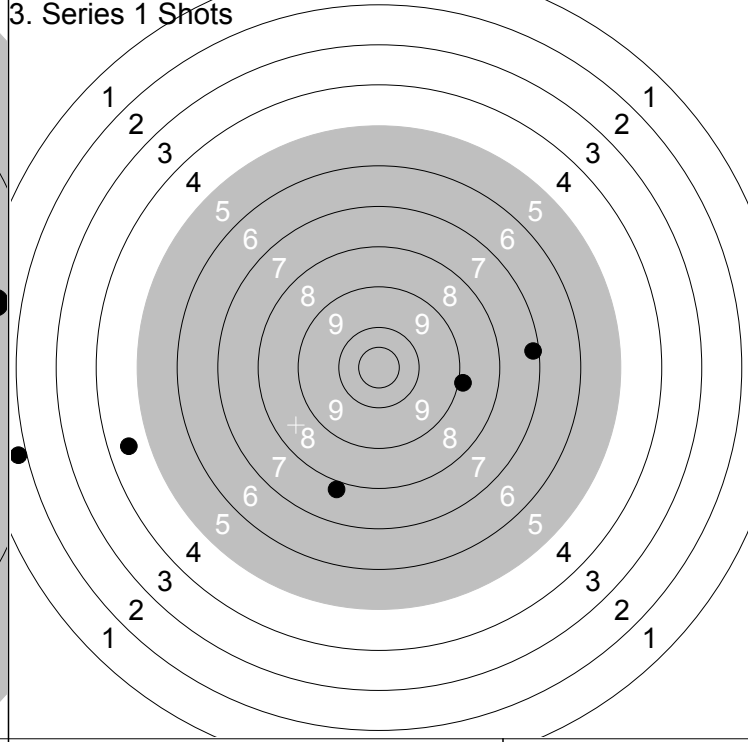
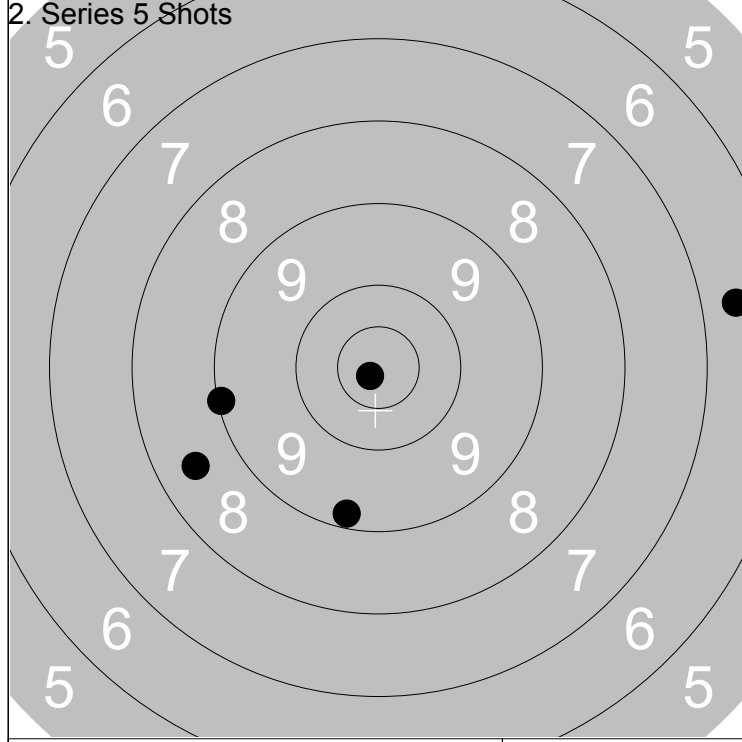

1: 9.1 ←	Series    42.0
2: *10.8 ↘	
3: 9.2 ↓	
4: 6.6 →	
5: 8.5 ←	
Total    344.0	

1: 7.8 ↓	Series    27.0
2: 4.5 ←	
3: 8.9 →	
4: 7.2 →	
5: 1.8 ←	
Total    371.0	

Relay	Lane	Tony Jansson	
<b>5</b>	<b>19</b>		

300m	Ununge	19	St
------	--------	----	----

07.07.2014	Tavelträffen B 2014	Ramselefors SKF
------------	---------------------	-----------------

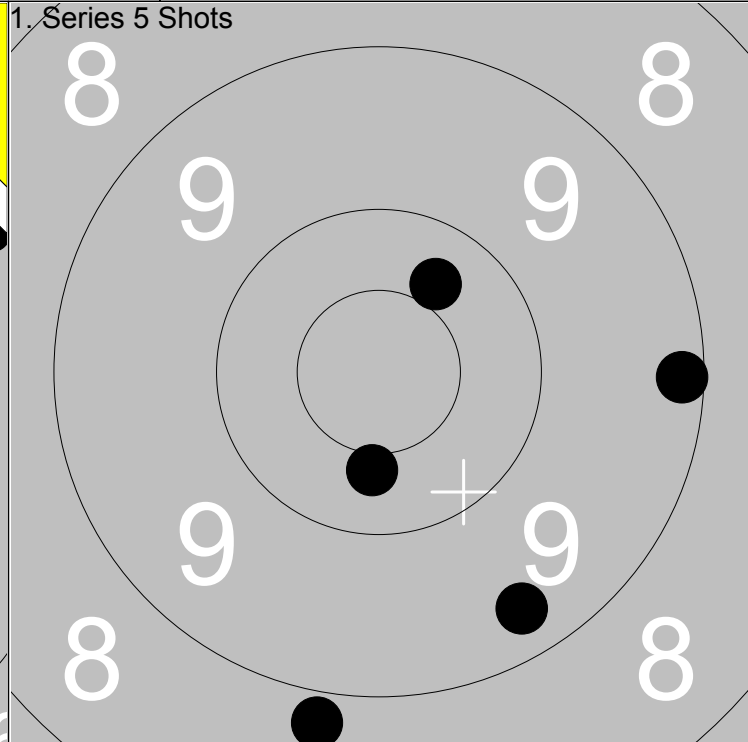
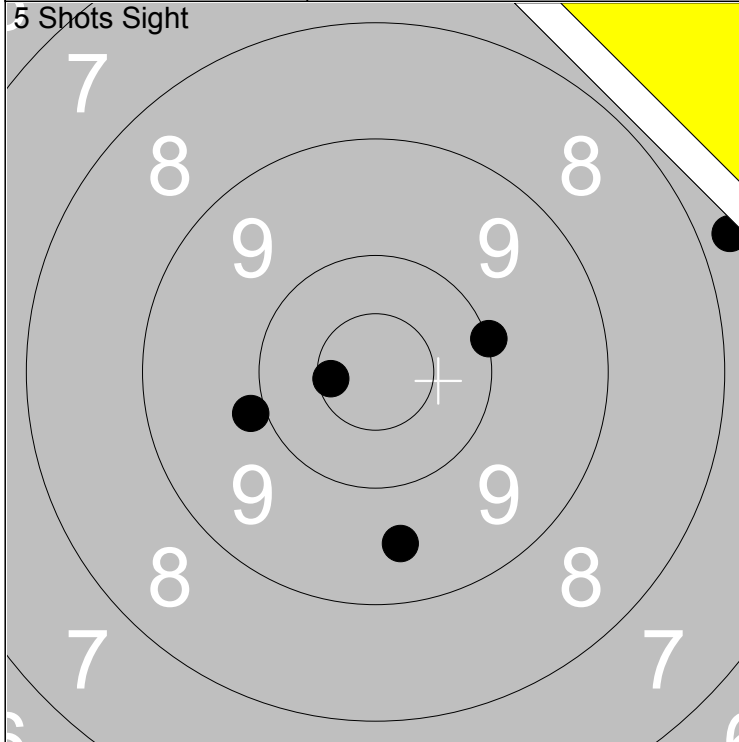

1: 9.5 ↓	Series	45.0
2: *10.6 ←		
3: 9.9 ←	Total	250.0
4: 10.0 →		
5: 7.8 →		

1: 9.2 →	Series	46.0
2: 10.4 ↓		
3: 8.8 ↓	Total	296.0
4: 10.4 ↗		
5: 9.3 ↓		

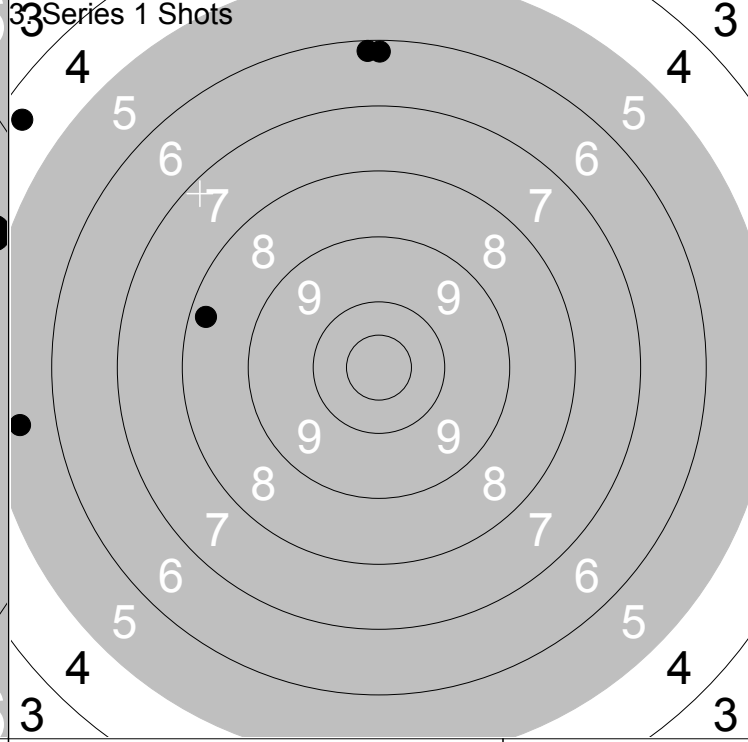
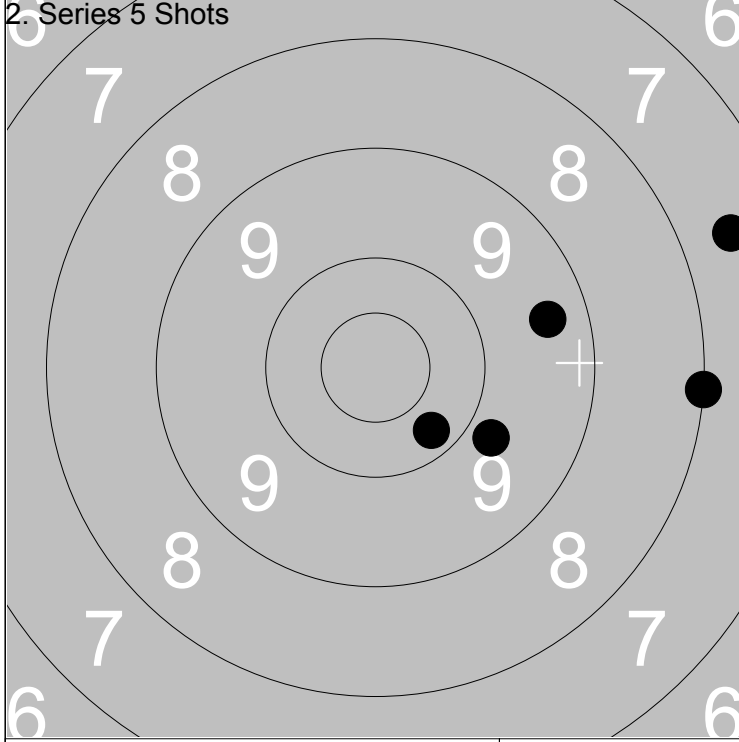

1: 7.6 →	Series	43.0
2: 9.4 →		
3: 10.2 ↓	Total	339.0
4: 8.0 →		
5: 9.8 ↓		

1: 5.5 ←	Series	29.0
2: 6.2 ↑		
3: 8.3 ←	Total	368.0
4: 4.4 ↖		
5: 6.2 ↑		

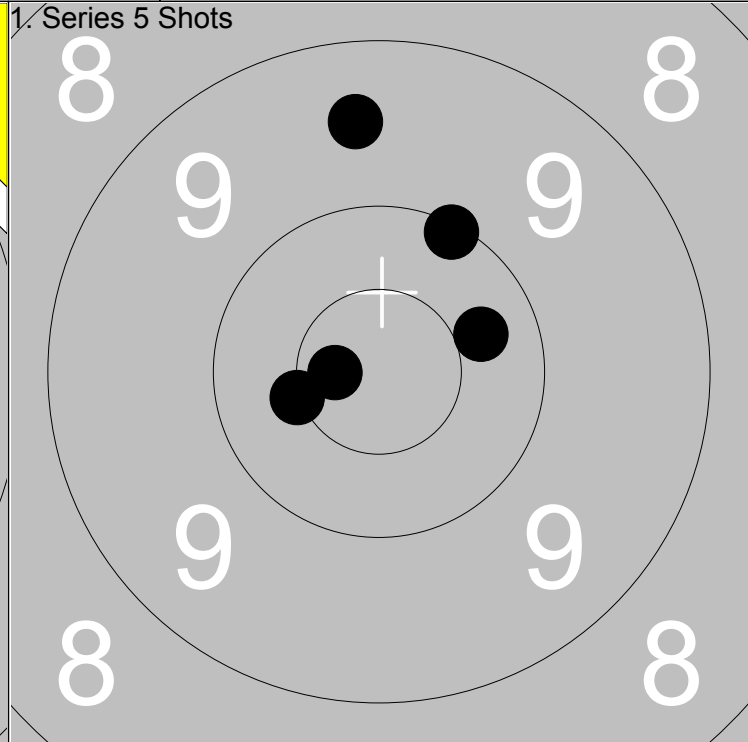
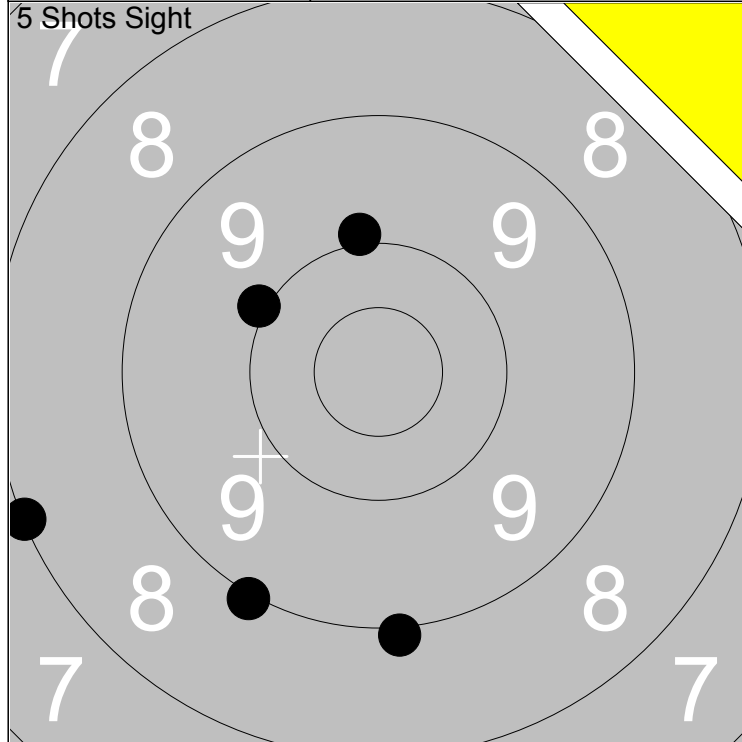

1: 9.0 ↓	Series	45.0
2: 9.9 ↑		
3: 10.0 ↖	Total	137.0
4: 8.0 ←		
5: 9.0 ↓		

1: 10.3 →	Series	49.0
2: 9.5 ↑		
3: *10.5 ↖	Total	186.0
4: 10.1 ↗		
5: *10.7 ↖		

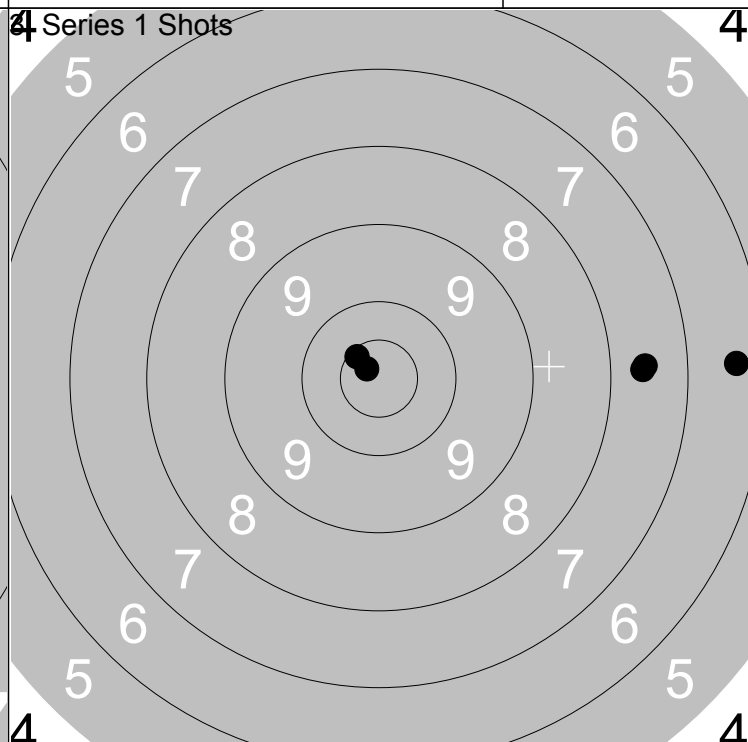
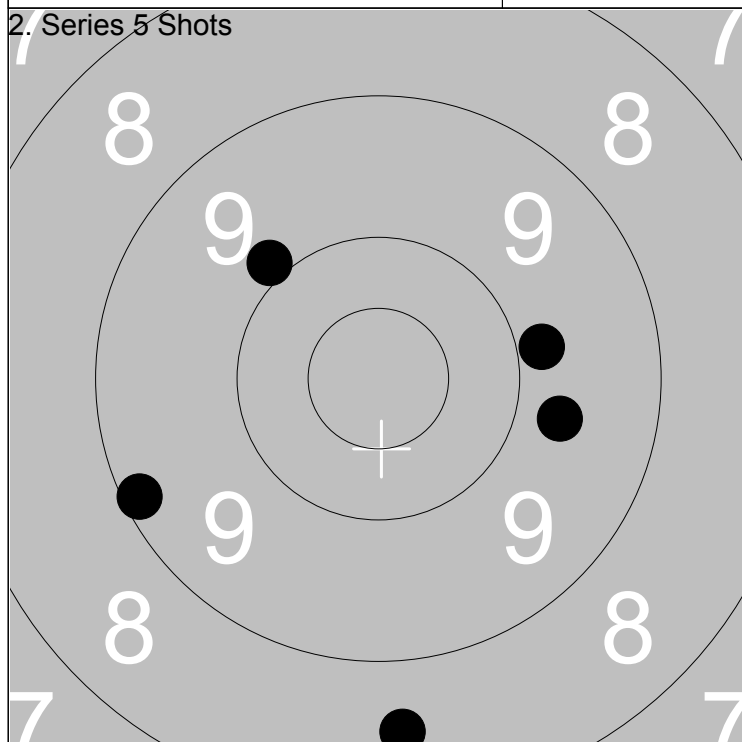

1: 9.9 ↗	Series	44.0
2: 9.8 →		
3: 9.7 →	Total	230.0
4: 8.5 ↓		
5: 9.1 ↖		

1: *10.8 ↖	Series	40.0
2: 7.6 →		
3: *10.6 ↖	Total	270.0
4: 7.6 →		
5: 6.4 →		

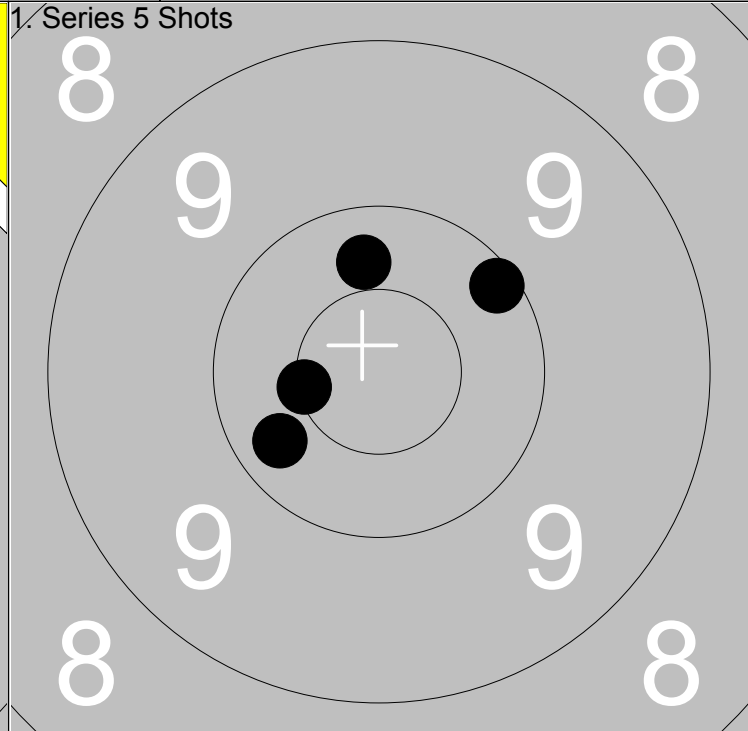
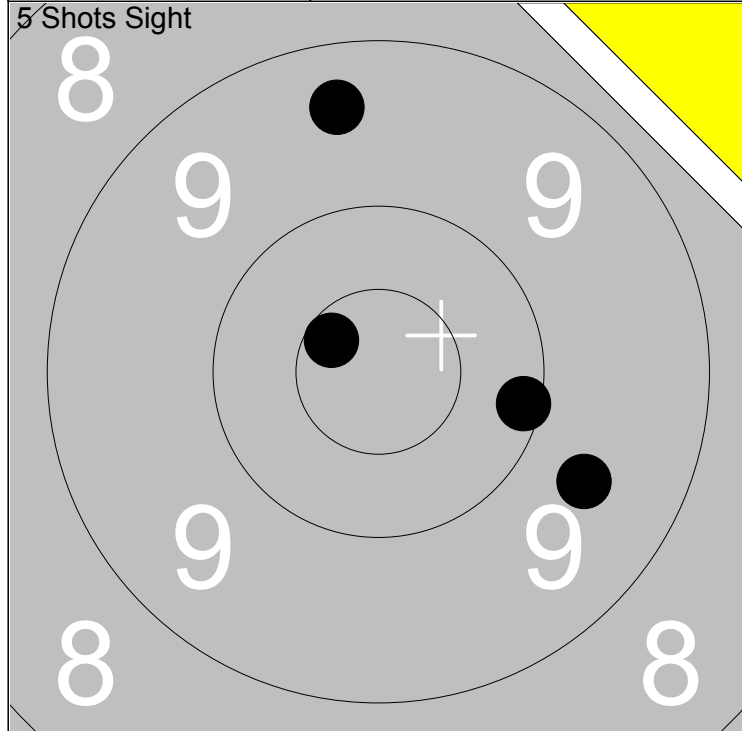

1: 9.6 ➤	Series	38.0
2: 10.1 ➔		
3: 9.4 ↑	Total	274.0
4: *10.6 ↙		

1: 0.0	Series	40.0
2: *10.5 ↙		
3: 10.3 ↑	Total	314.0
4: 10.1 ↗		
5: 10.3 ↙		

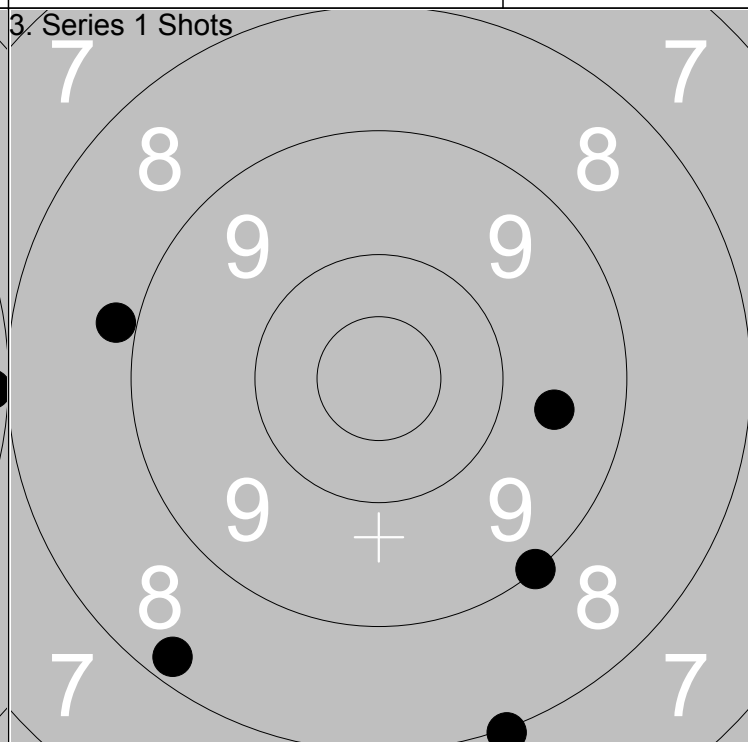
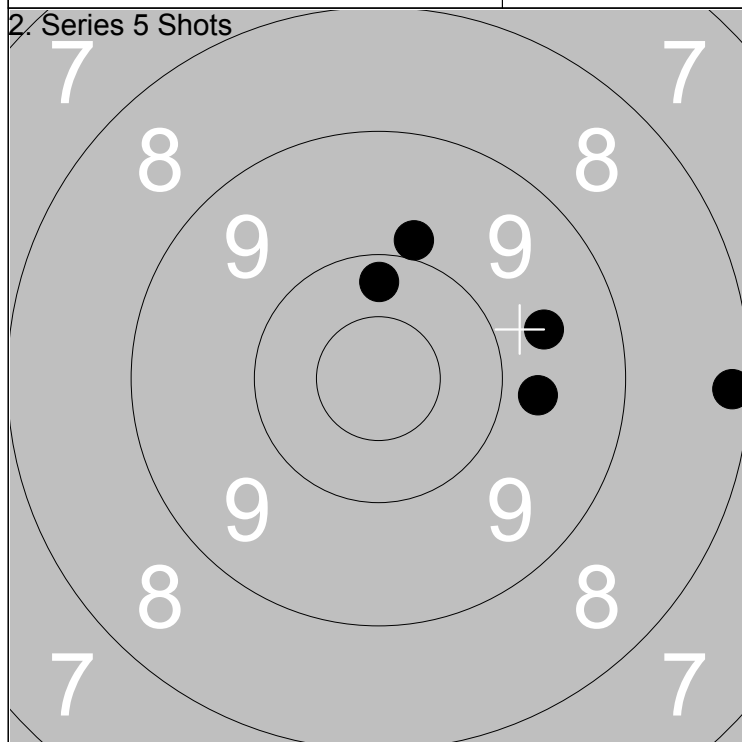

1: 9.6 ➔	Series	45.0
2: 8.2 ➔		
3: 9.7 ➔	Total	359.0
4: 9.9 ↑		
5: 10.2 ↑		

1: 9.6 ➔	Series	42.0
2: 8.9 ↙		
3: 8.0 ↓	Total	401.0
4: 8.2 ↙		
5: 9.0 ↓		

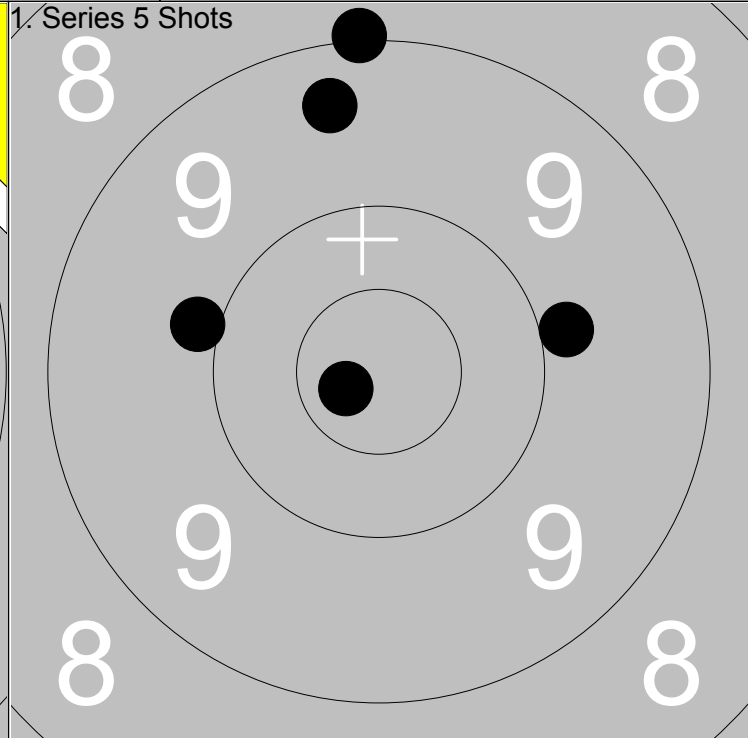
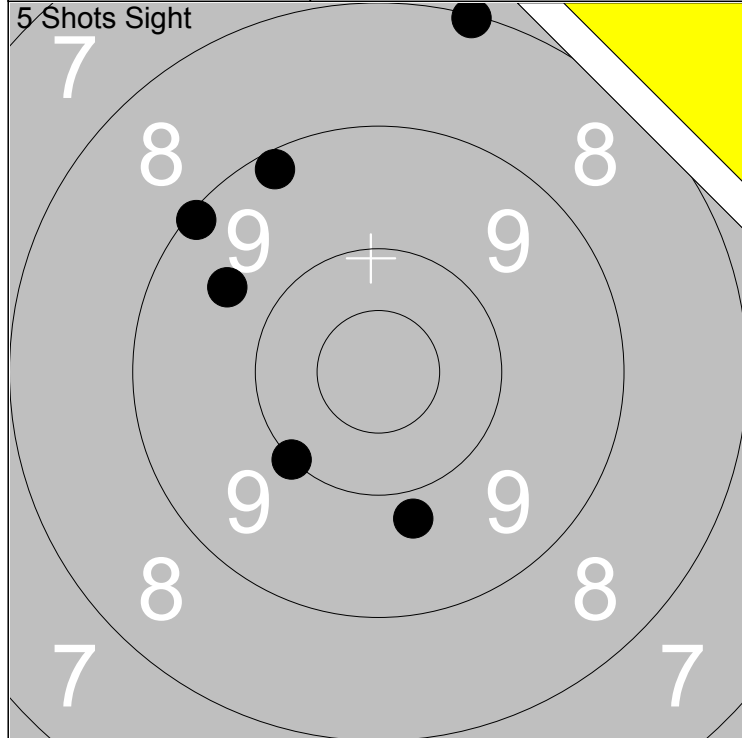

1: 7.7 ↗	6: 9.8 ↓	<b>Series</b>	<b>61.0</b>
2: 9.2 ↗	7: 8.1 ↑		
3: 9.6 ↖		<b>Total</b>	<b>268.0</b>
4: 9.1 ↖			
5: 10.0 ↘			

1: 9.9 →	<b>Series</b>	<b>46.0</b>
2: 9.0 ↑		
3: *10.7 ↙	<b>Total</b>	<b>314.0</b>
4: 9.9 ←		
5: 9.4 ↑		

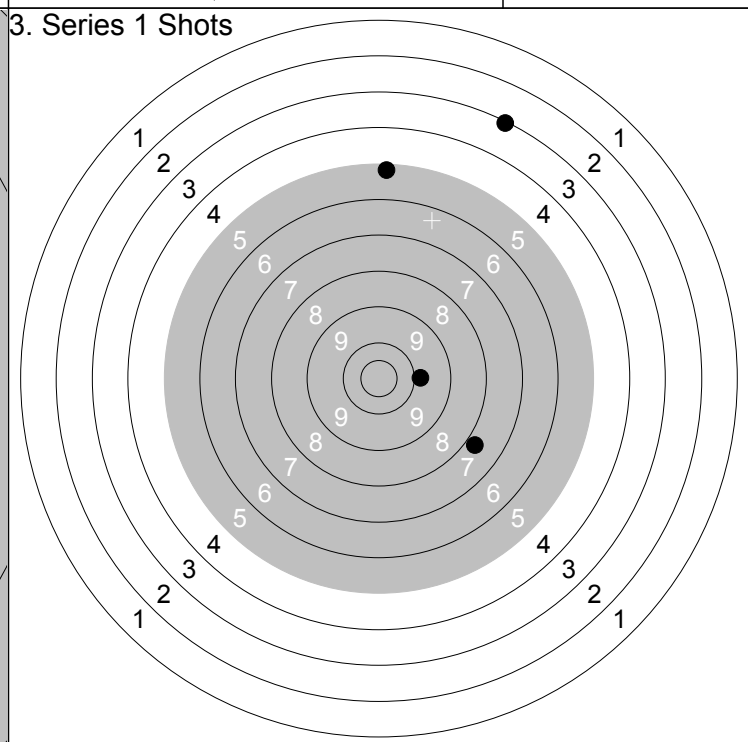
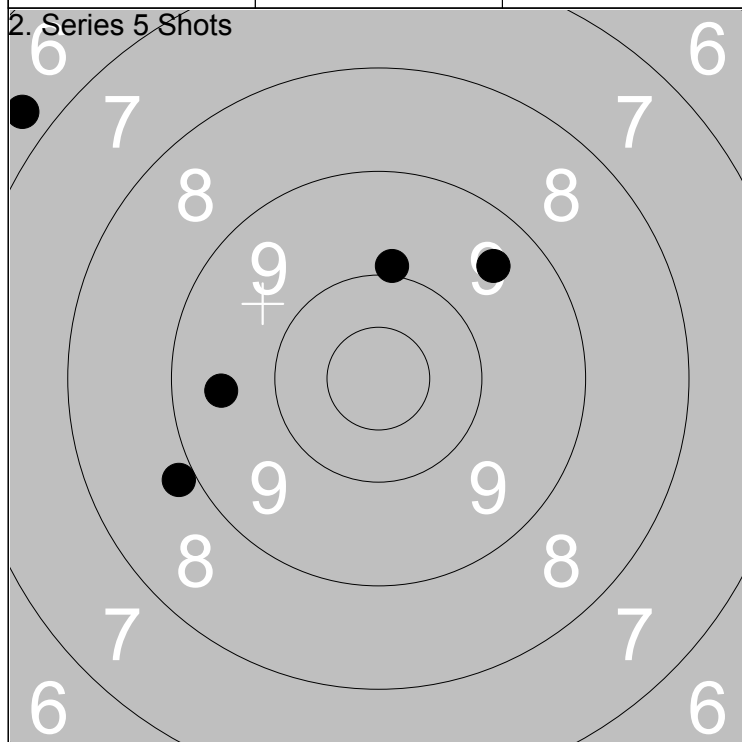

1: 9.5 ↗	<b>Series</b>	<b>41.0</b>
2: 6.7 ↖		
3: 9.9 ↑	<b>Total</b>	<b>355.0</b>
4: 9.5 ←		
5: 8.9 ↙		

1: 0.0 ↑	<b>Series</b>	<b>24.0</b>
2: 3.1 ↗		
3: 5.2 ↑	<b>Total</b>	<b>379.0</b>
4: 7.8 ↘		
5: 9.9 →		



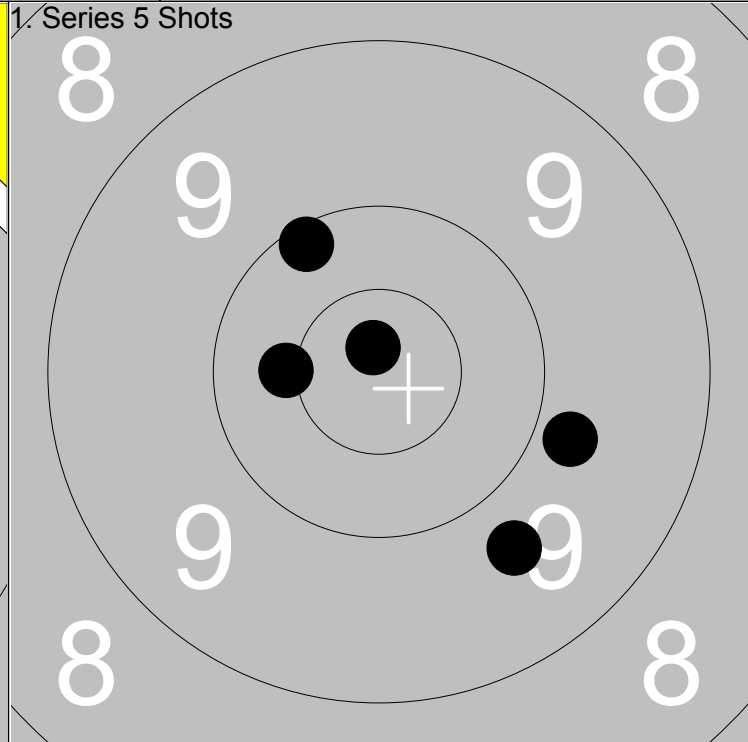
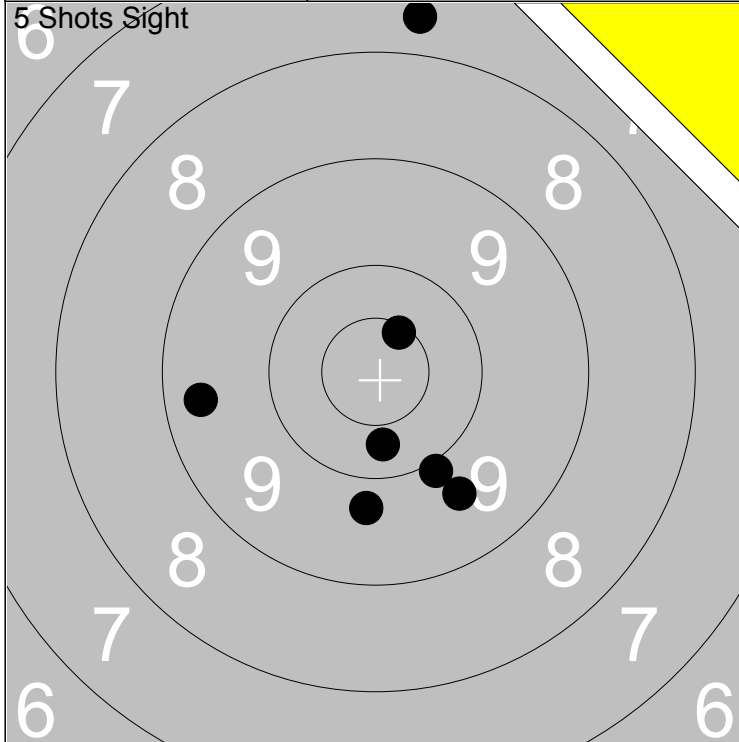

1: 10.3 ↓	6: 7.7 ↑	Series	63.0
2: 9.8 ↓	7: *10.6 ↗		
3: 9.9 ↓		Total	261.0
4: 9.4 ←			
5: 9.6 ↓			

1: 9.7 ↘	Series	48.0
2: *10.8 ↑		
3: *10.4 ←	Total	309.0
4: 10.1 ↖		
5: 9.8 →		

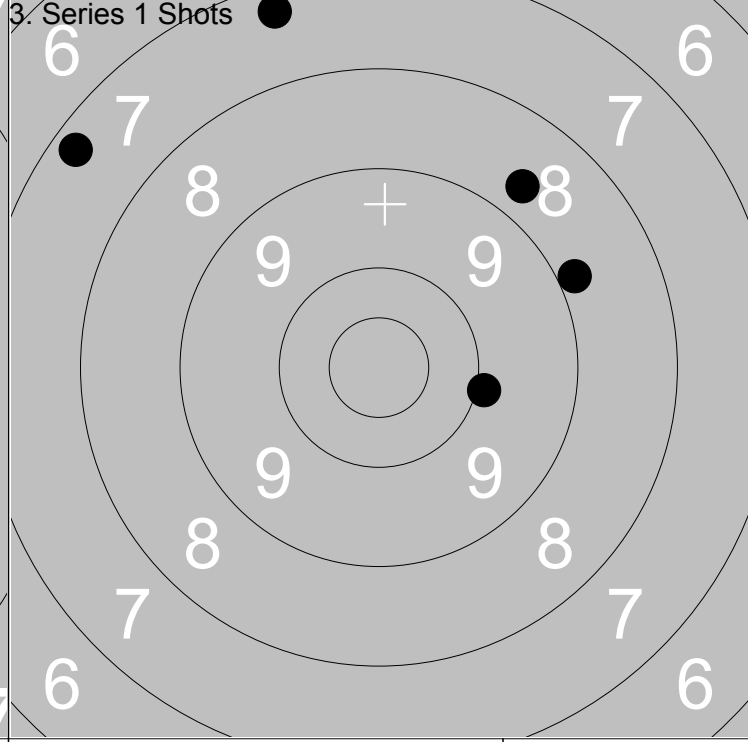
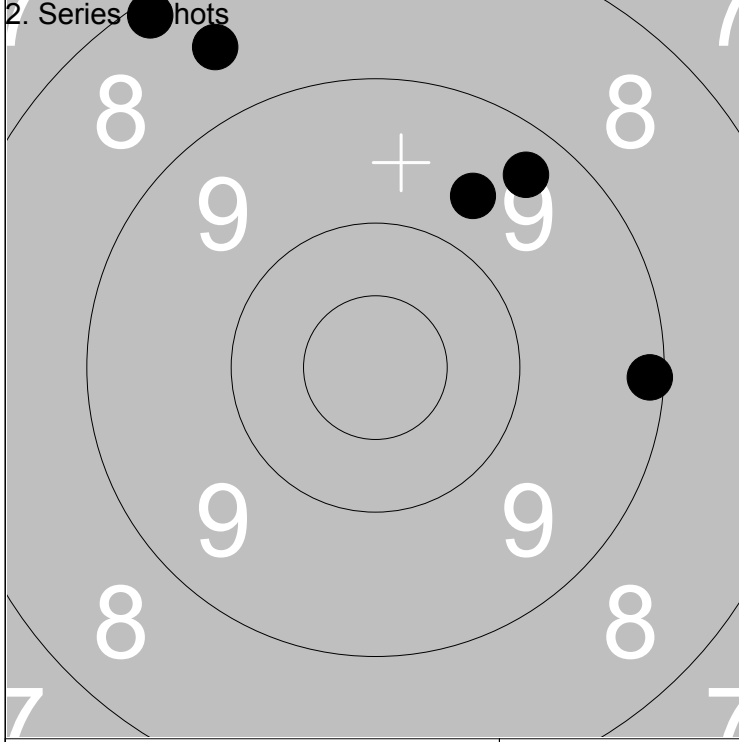

1: 8.1 ↖	Series	43.0
2: 9.3 ↗		
3: 9.1 →	Total	352.0
4: 9.7 ↗		
5: 8.5 ↖		

1: 9.9 →	Series	39.0
2: 7.3 ↑		
3: 7.3 ↖	Total	391.0
4: 8.9 →		
5: 8.7 ↗		

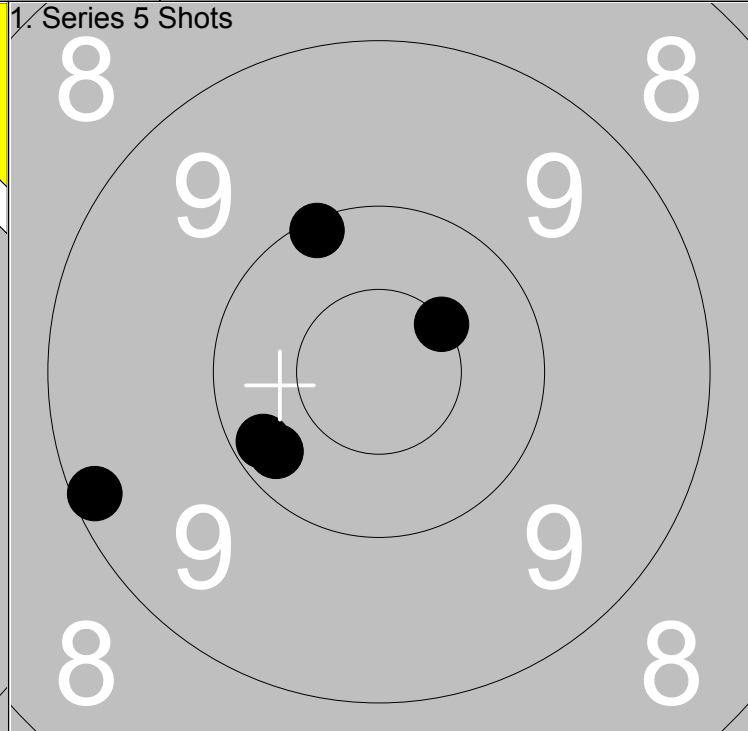
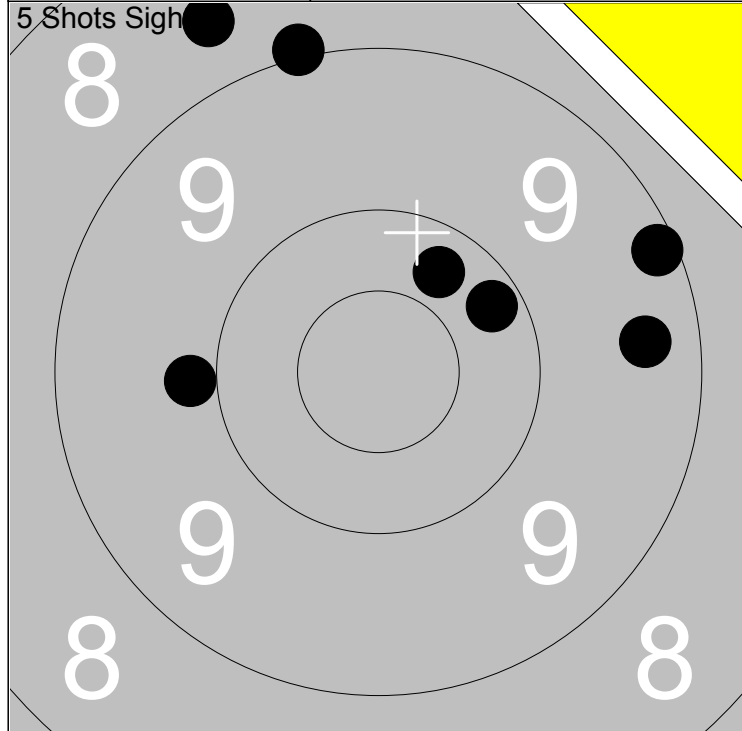

1: 9.0 ↑	6: 9.2 ↗	Series	64.0
2: 10.3 ↗	7: 8.6 ↖		
3: 10.2 ↗		Total	247.0
4: 9.4 →			
5: 9.9 ←			

1: *10.5 ↗	Series	49.0
2: 9.2 ↖		
3: 10.1 ↖	Total	296.0
4: 10.2 ↖		
5: 10.2 ↖		

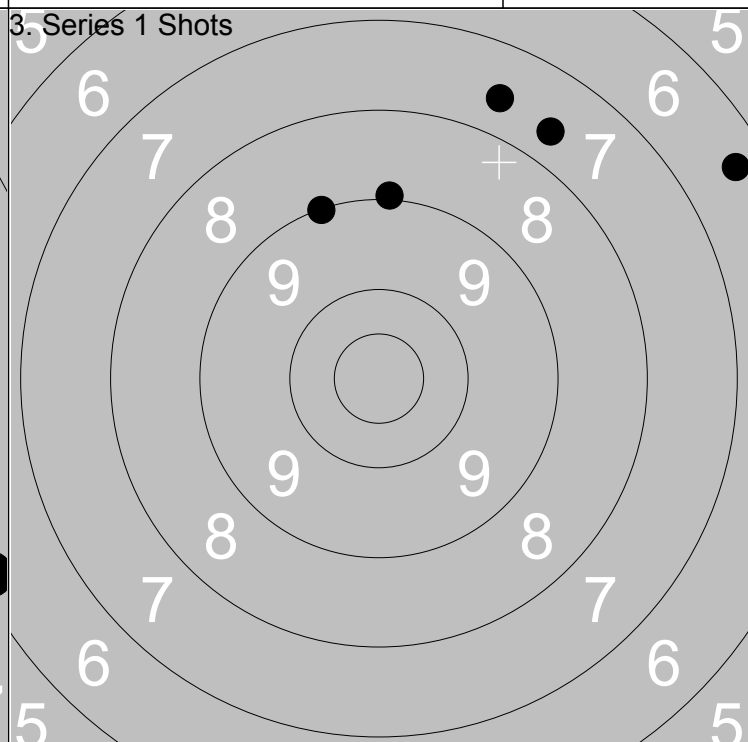
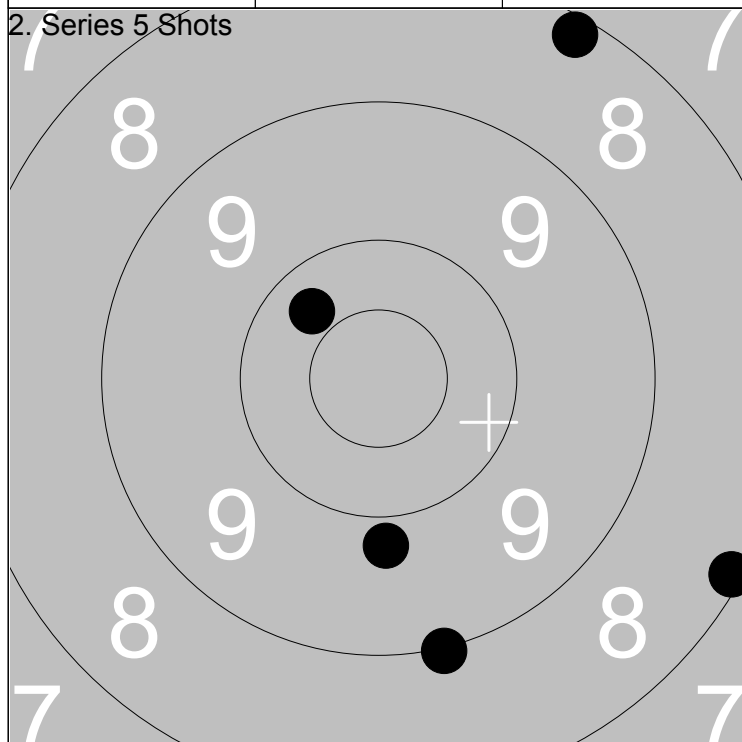

1: 9.8 ↓	Series	44.0
2: 8.2 ↗		
3: 8.1 ↗	Total	340.0
4: 9.0 ↓		
5: 10.3 ↖		

1: 6.4 ↗	Series	38.0
2: 7.6 ↗		
3: 9.0 ↖	Total	378.0
4: 9.0 ↑		
5: 7.7 ↗		

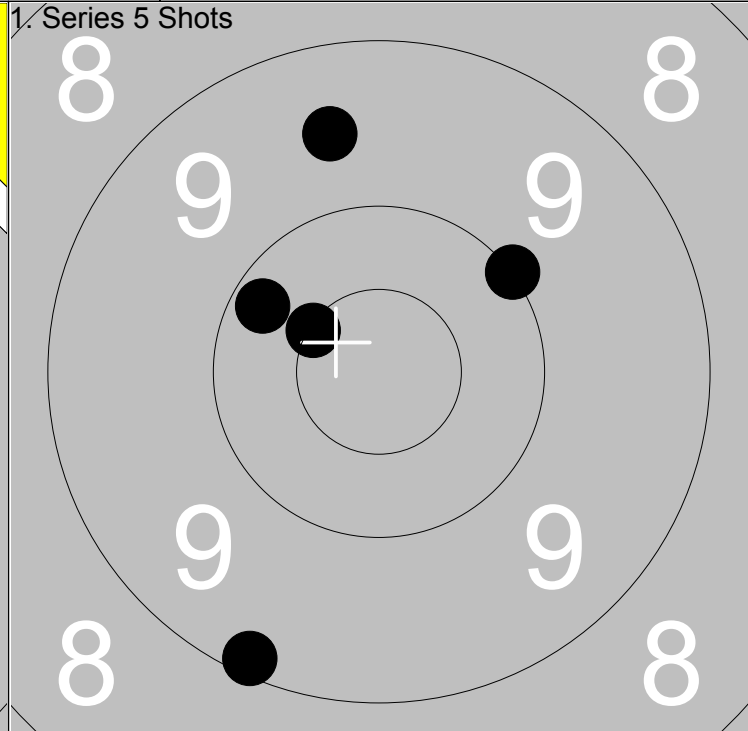
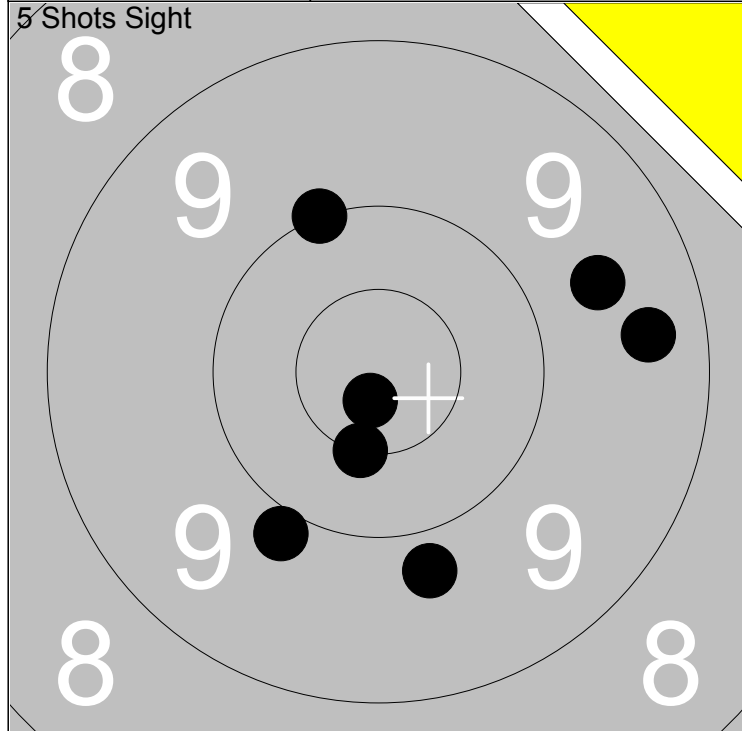

1: 9.6 →	6: *10.8 ↓	Series	66.0
2: 10.0 ↑	7: 9.8 ↓		
3: 9.4 →		Total	288.0
4: 9.9 ↓			
5: *10.5 ↓			

1: 10.2 ↖	Series	48.0
2: 9.1 ↓		
3: *10.5 ↖	Total	336.0
4: 10.0 ↗		
5: 9.6 ↑		

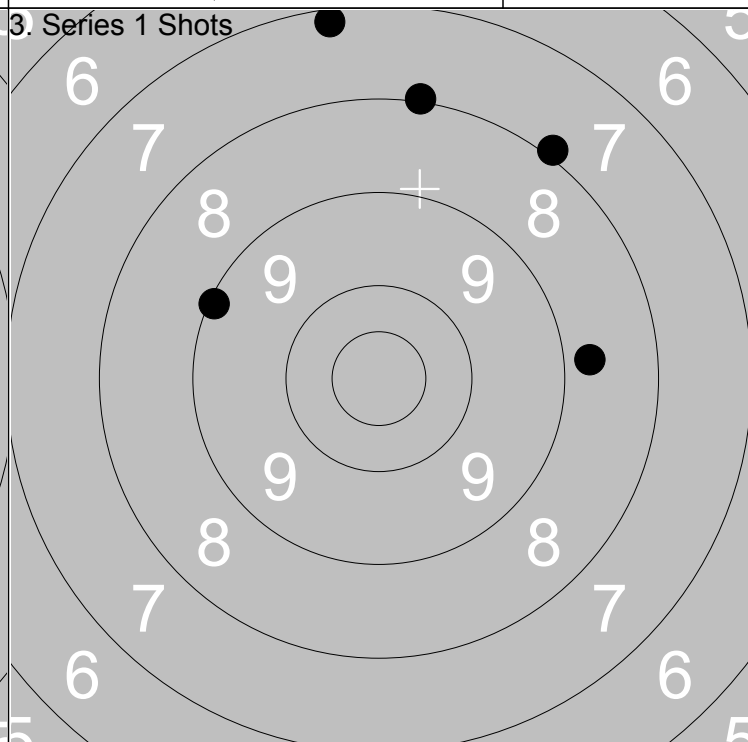
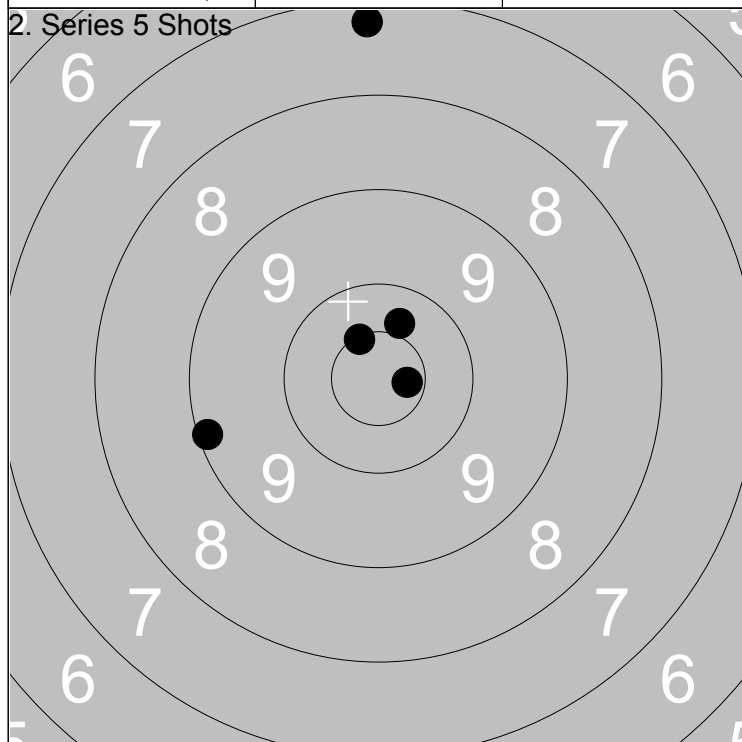

1: 7.3 ↑	Series	46.0
2: 10.4 ↑		
3: 9.1 ←	Total	382.0
4: *10.5 ↖		
5: *10.7 →		

1: 8.8 →	Series	39.0
2: 9.1 ↖		
3: 7.2 ↑	Total	421.0
4: 8.0 ↑		
5: 7.9 ↗		

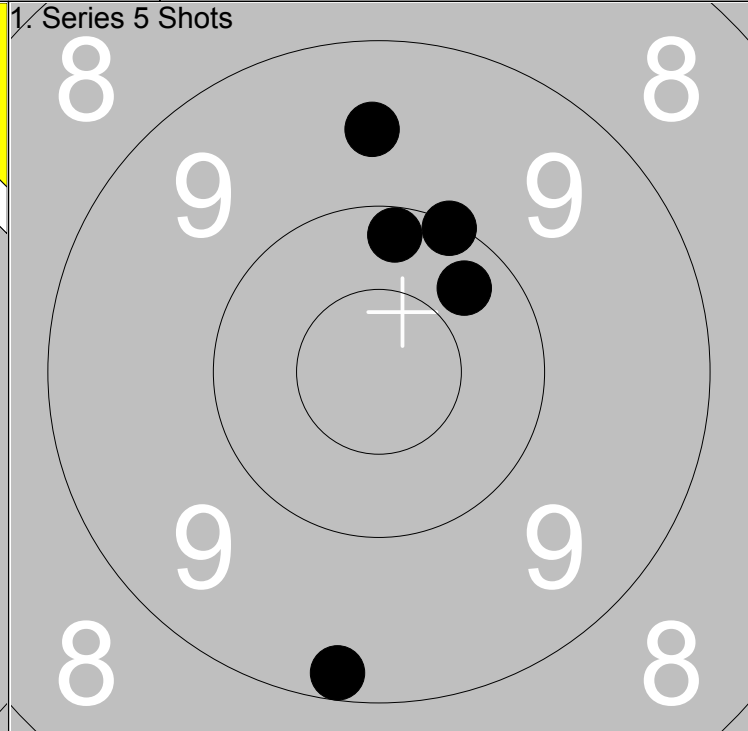
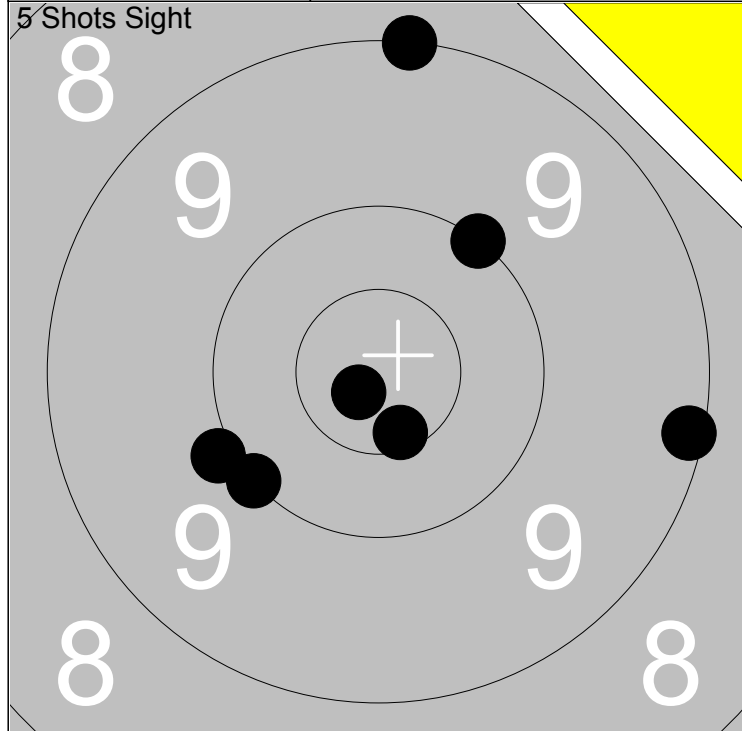

1: 9.1 →	6: 9.0 ↑	Series 67.0
2: *10.6 ↓	7: 10.0 ↗	
3: 10.0 ↙		Total 282.0
4: 9.9 ←		
5: *10.8 ↙		

1: 10.3 ↗	Series 48.0
2: 9.6 ↑	
3: 10.2 ↑	Total 330.0
4: 9.2 ↓	
5: 10.1 ↗	

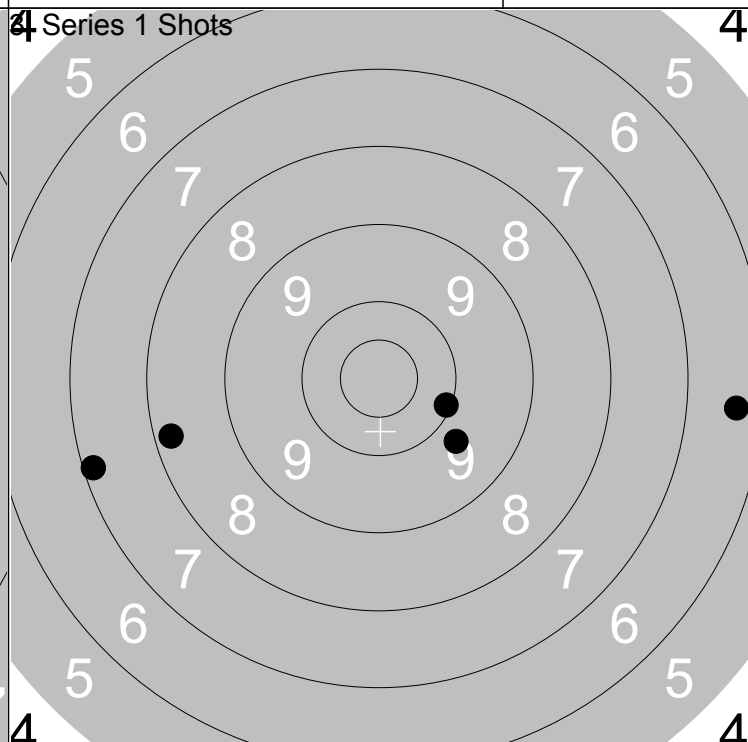
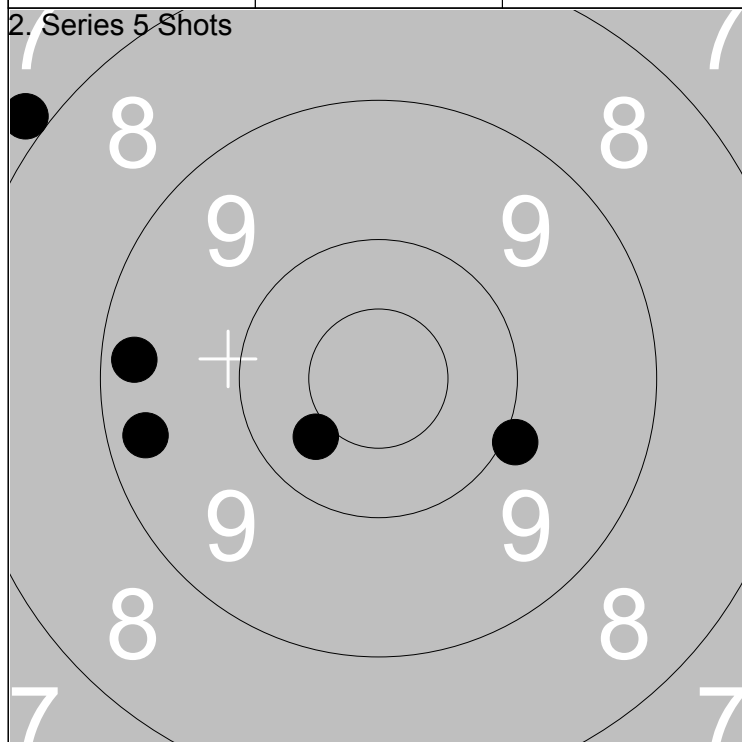

1: 7.9 ↖	Series 44.0
2: 9.9 →	
3: 9.3 ←	Total 374.0
4: 10.4 ↙	
5: 9.3 ←	

1: 7.2 ←	Series 40.0
2: 8.2 ←	
3: 6.4 →	Total 414.0
4: 10.1 →	
5: 9.7 ↘	

Relay <b>6</b>	Lane <b>12</b>	<b>Peter Östling</b>	
-------------------	-------------------	----------------------	--

300m	F 21	12	No
------	------	----	----

07.07.2014	Tavelträffen B 2014	Ramselefors SKF
------------	---------------------	-----------------

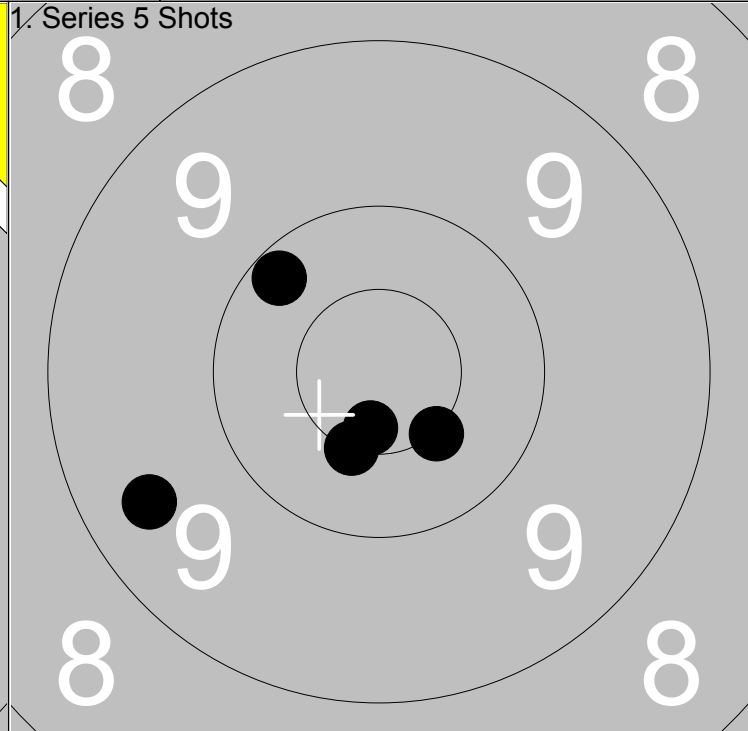
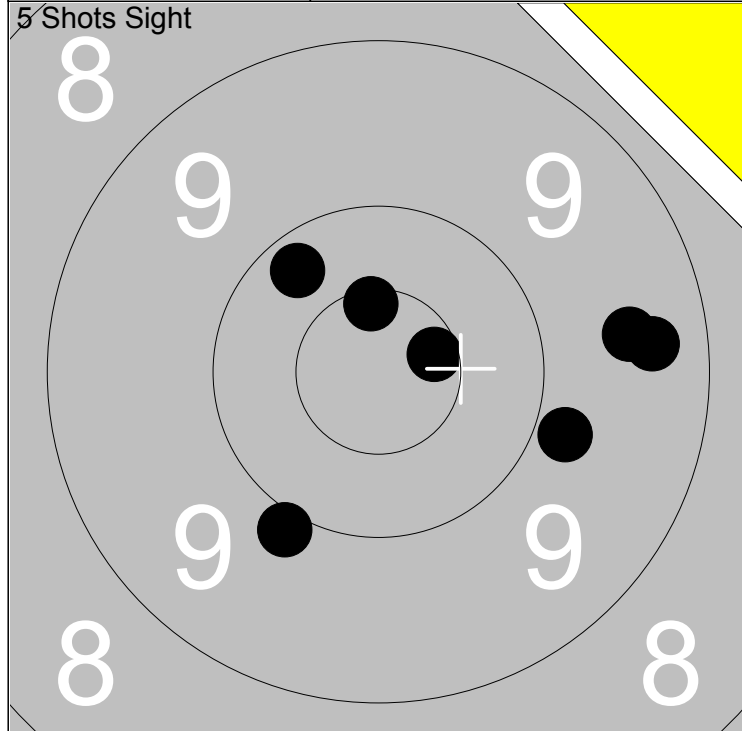

1: *10.6 →	6: 10.2 ↖	Series 66.0
2: 9.5 →	7: 9.8 →	
3: 9.4 →		Total 280.0
4: 9.9 ↓		
5: *10.6 ↑		

1: *10.5 ↓	Series 49.0
2: 10.2 ↖	
3: *10.6 ↓	Total 329.0
4: 9.4 ↙	
5: *10.5 ↓	

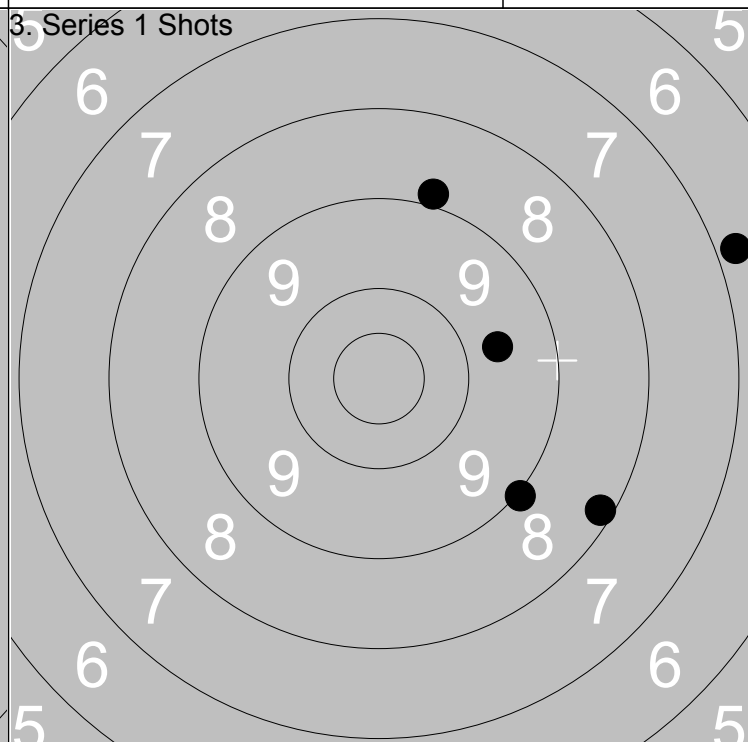
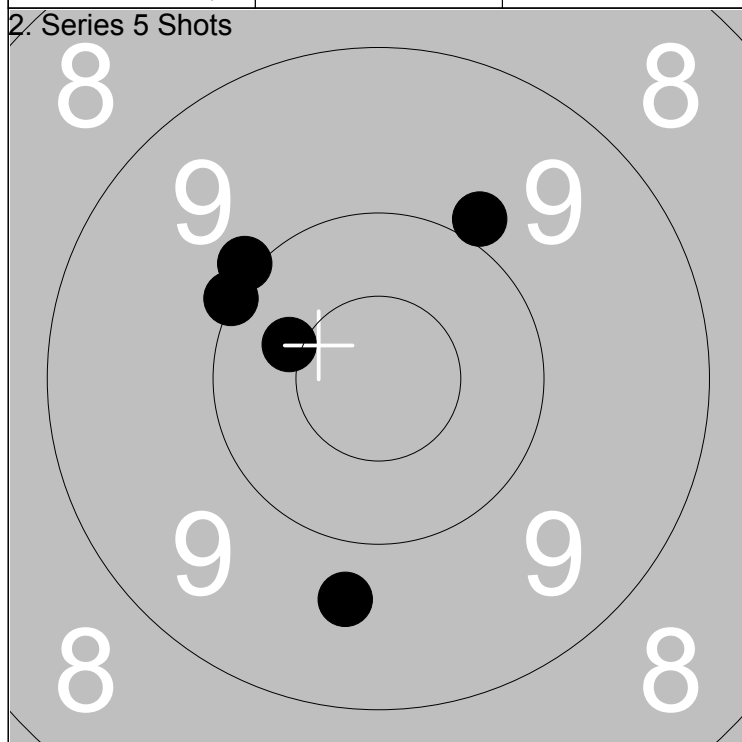

1: 9.7 ↓	Series 48.0
2: 10.0 ↖	
3: *10.4 ↖	Total 377.0
4: 9.9 ↗	
5: 10.0 ↖	

1: 8.2 →	Series 40.0
2: 8.9 ↑	
3: 9.0 ↓	Total 417.0
4: 9.7 →	
5: 6.8 →	

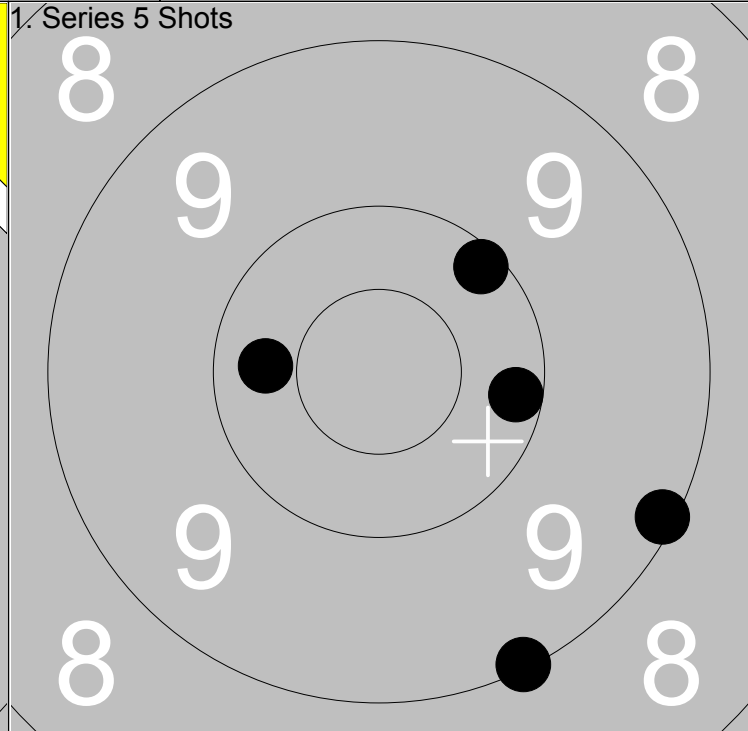
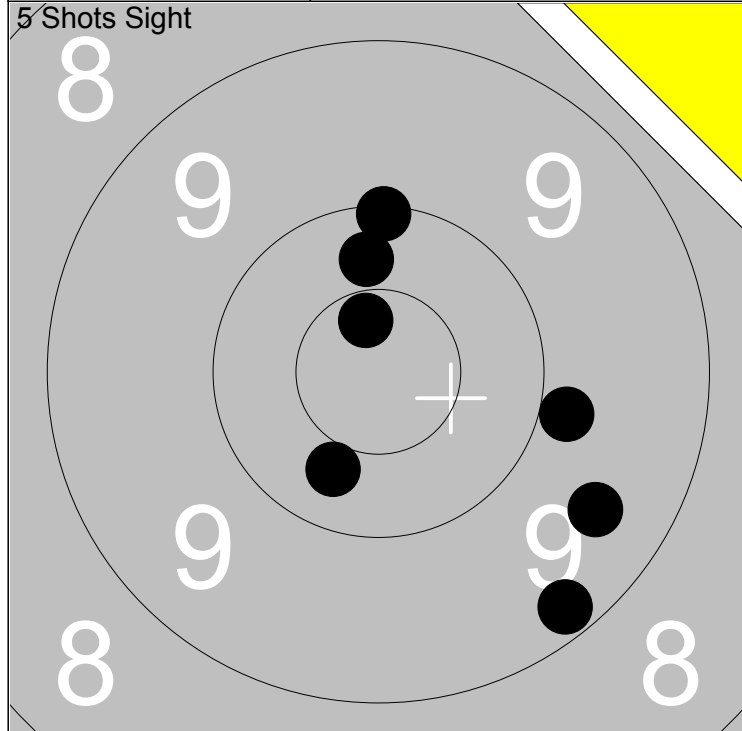

1: 9.5 ↘	6: 10.3 ↙	Series	67.0
2: *10.7 ↑	7: 10.1 ↑		
3: 10.3 ↑		Total	279.0
4: 9.9 →			
5: 9.2 ↘			

1: 9.1 →	Series	48.0
2: 10.2 →		
3: 10.1 ↗	Total	327.0
4: 10.3 ←		
5: 9.1 ↘		

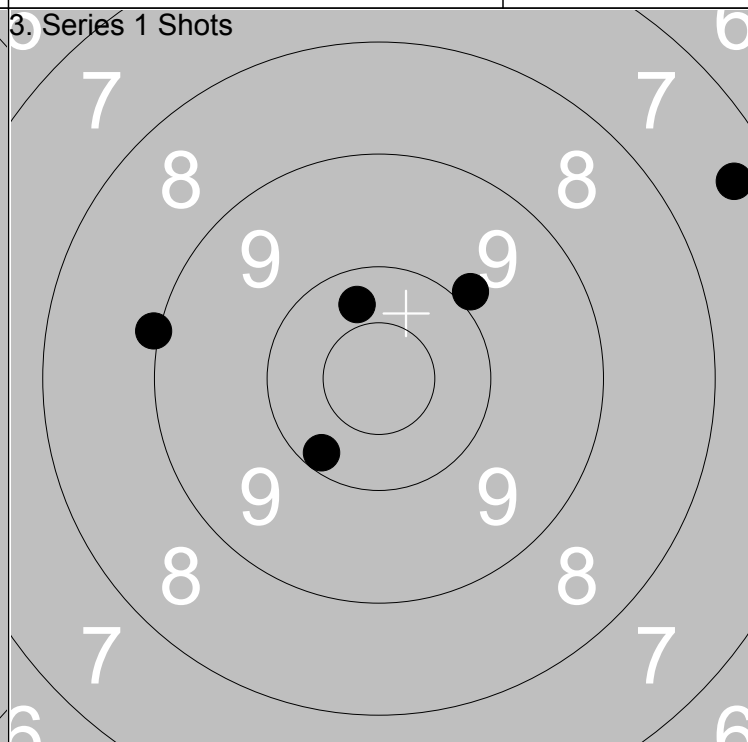
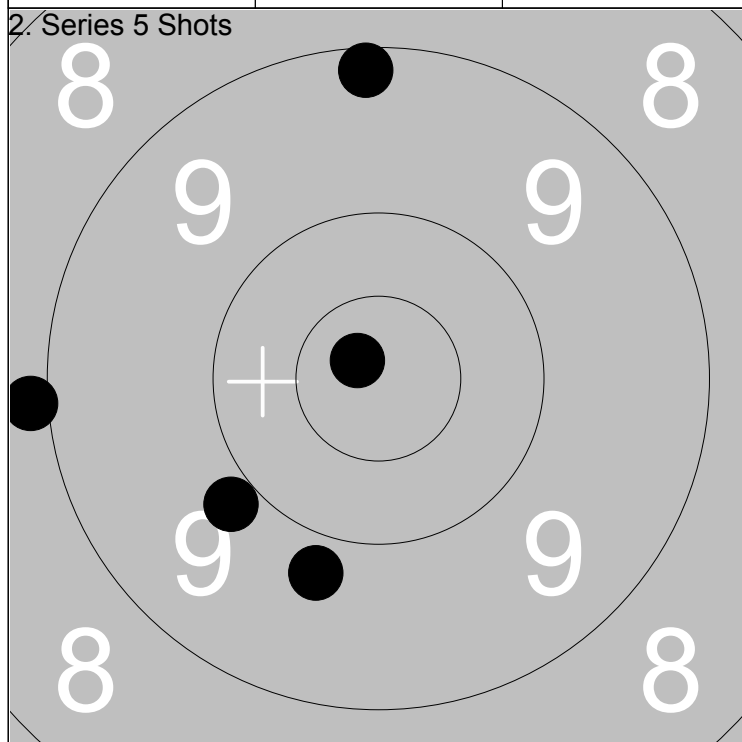

1: *10.8 ↖	Series	45.0
2: 9.2 ↑		
3: 8.9 ←	Total	372.0
4: 9.8 ↘		
5: 9.9 ↙		

1: 10.2 ↙	Series	45.0
2: 7.4 ↗		
3: 10.3 ↑	Total	417.0
4: 9.9 ↗		
5: 9.0 ←		

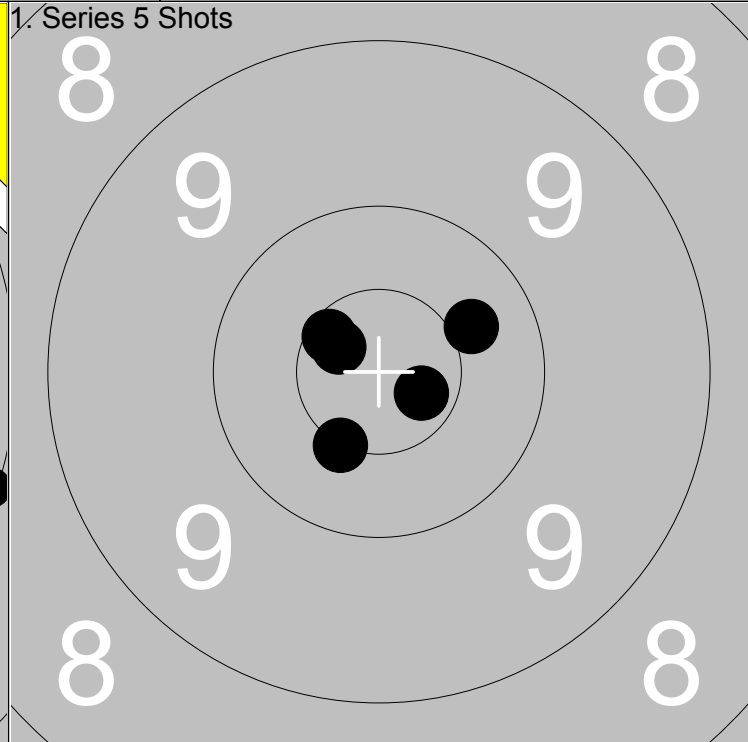
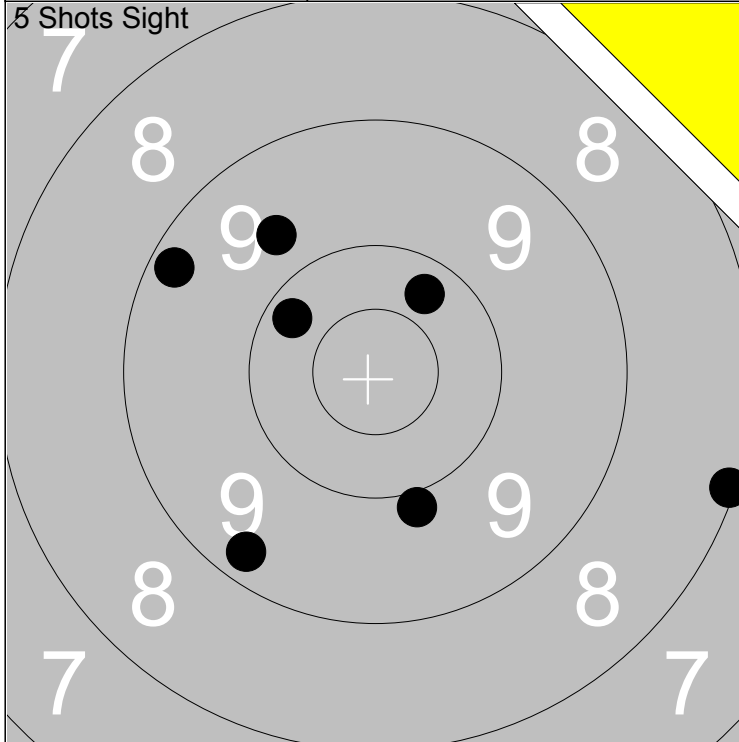

1: 8.1 →	6: 9.2 ↖	Series	64.0
2: 9.9 ↓	7: 9.3 ↙		
3: 10.3 ↗		Total	278.0
4: 9.7 ↗			
5: 10.2 ↖			

1: 10.4 ↗	Series	50.0
2: *10.7 ↖		
3: *10.5 ↓	Total	328.0
4: *10.6 ↖		
5: *10.7 →		

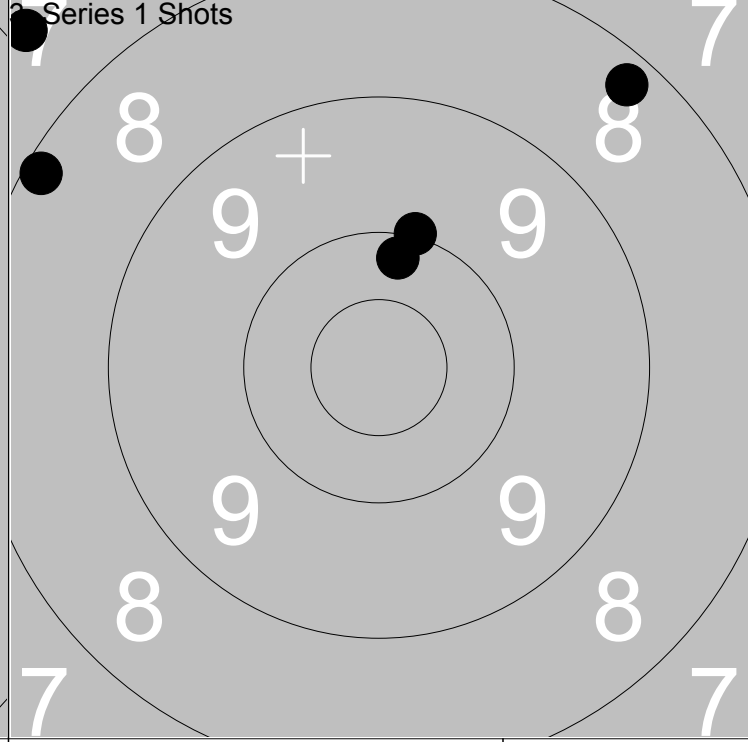
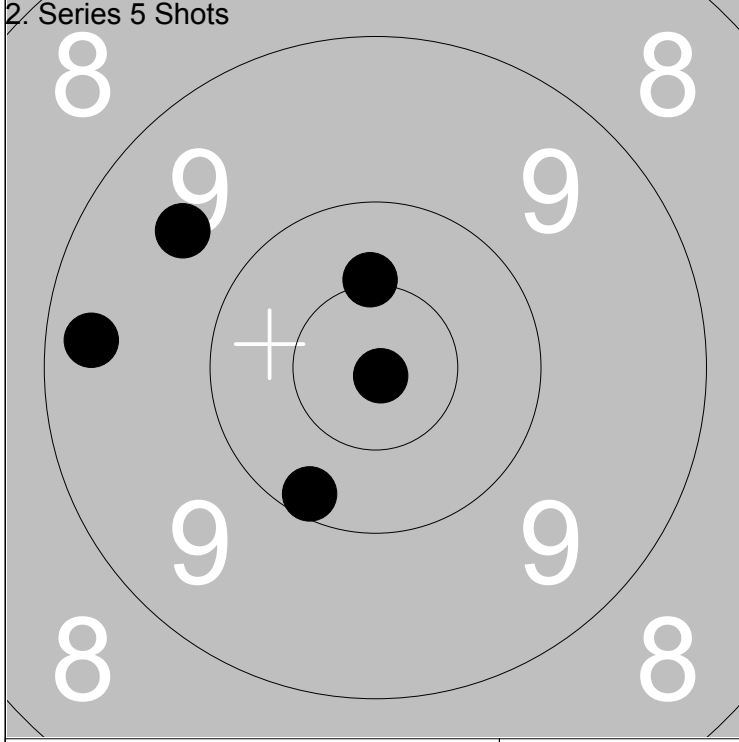

1: *10.9 ↓	Series	48.0
2: *10.5 ↑		
3: 9.3 ←	Total	376.0
4: 9.6 ↖		
5: 10.2 ↓		

1: 10.0 ↑	Series	43.0
2: 7.4 ↖		
3: 10.2 ↑	Total	419.0
4: 8.2 ↖		
5: 8.3 ↗		

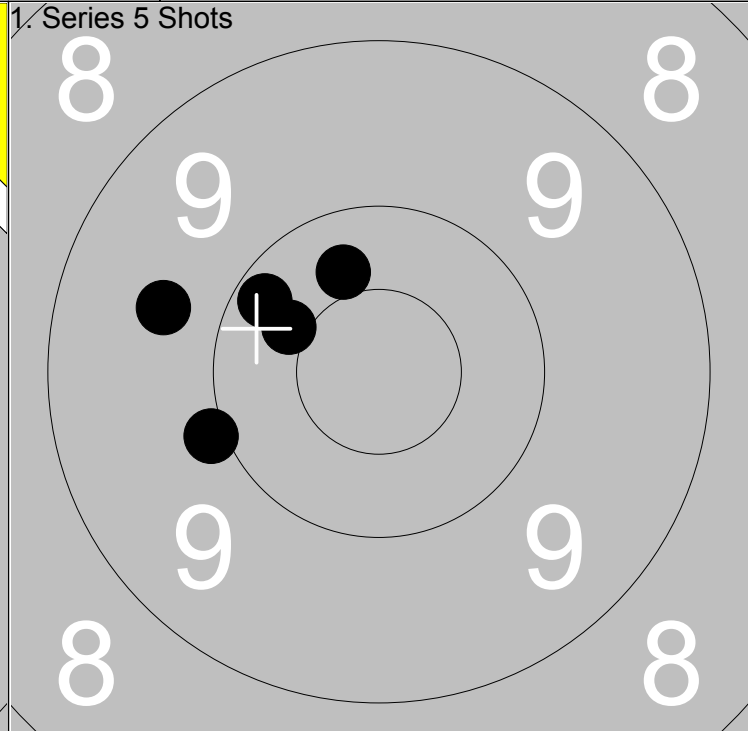
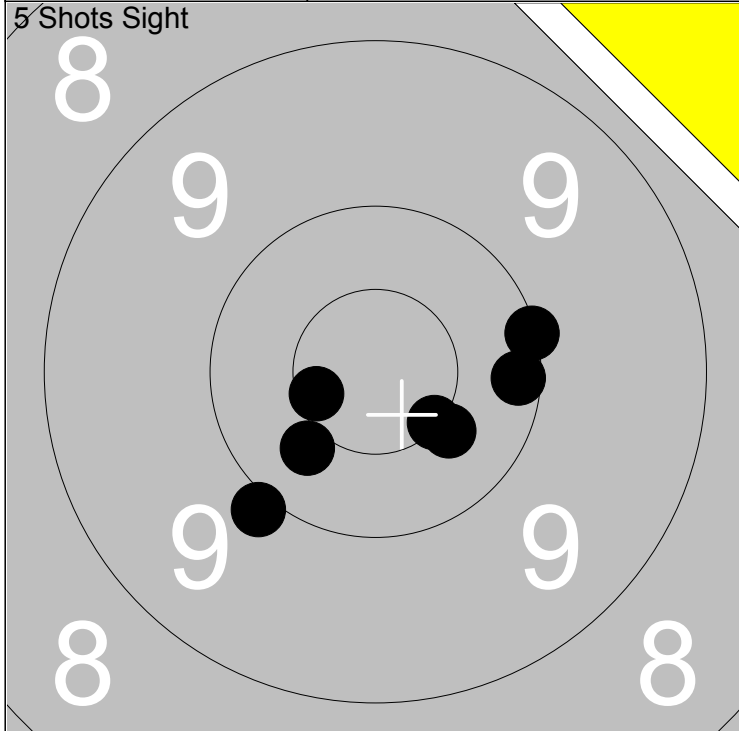

1: 10.1 →	6: *10.5 ↘	Series	69.0
2: 10.0 →	7: *10.6 ↙		
3: 10.4 ↙		Total	276.0
4: *10.4 ↘			
5: 9.9 ↙			

1: 10.4 ↗	Series	48.0
2: 9.9 ↙		
3: 9.7 ↙	Total	324.0
4: 10.2 ↙		
5: 10.4 ↙		

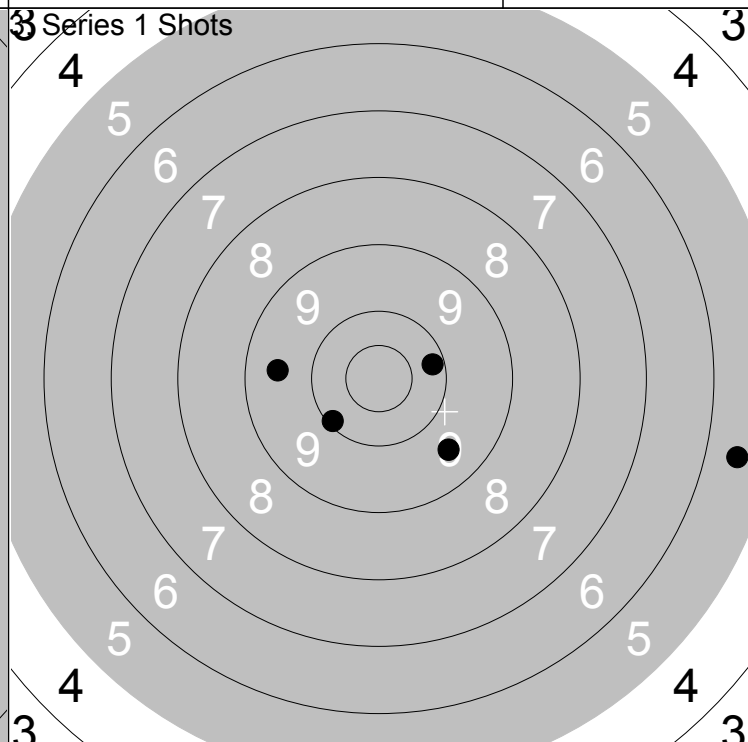
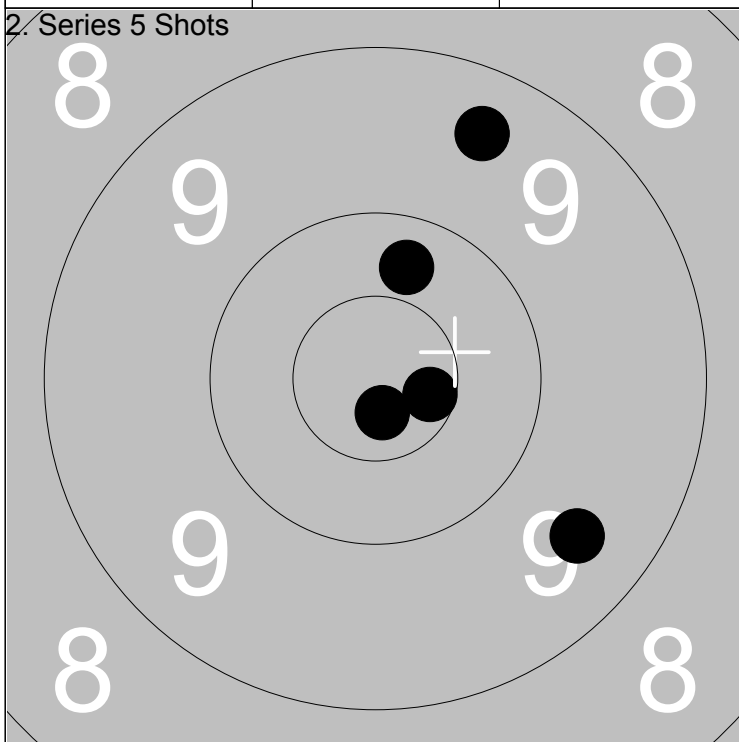

1: 9.5 ↘	Series	48.0
2: *10.6 →		
3: 9.4 ↗	Total	372.0
4: 10.3 ↗		
5: *10.8 ↘		

1: 9.5 ↘	Series	43.0
2: 5.5 →		
3: 10.2 →	Total	415.0
4: 10.1 ↙		
5: 9.5 ↙		



Relay <b>6</b>	Lane <b>16</b>	<b>Martin Nilsson</b>
-------------------	-------------------	-----------------------

300m	Kvistbro	16	Ör
------	----------	----	----

07.07.2014	Tavelträffen B 2014	Ramselefors SKF
------------	---------------------	-----------------

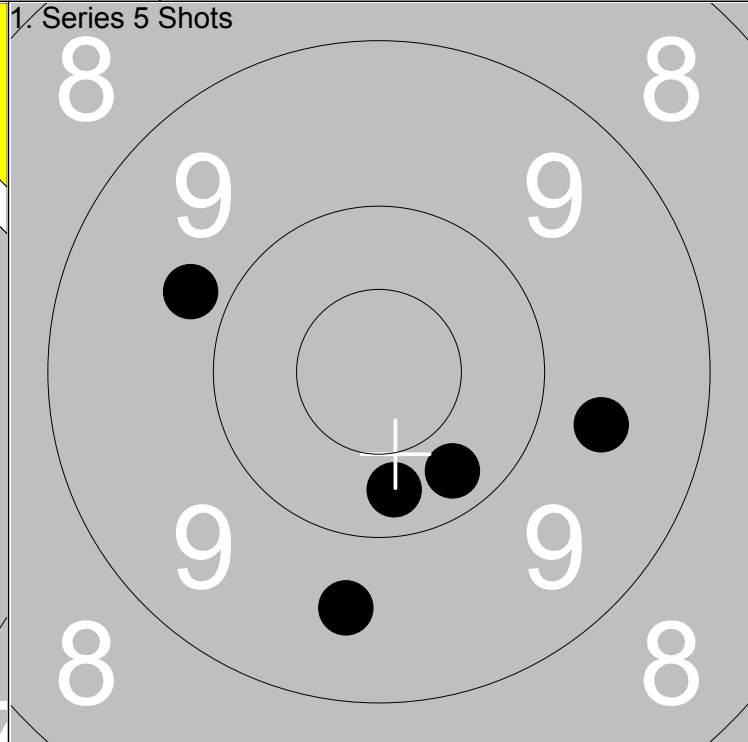
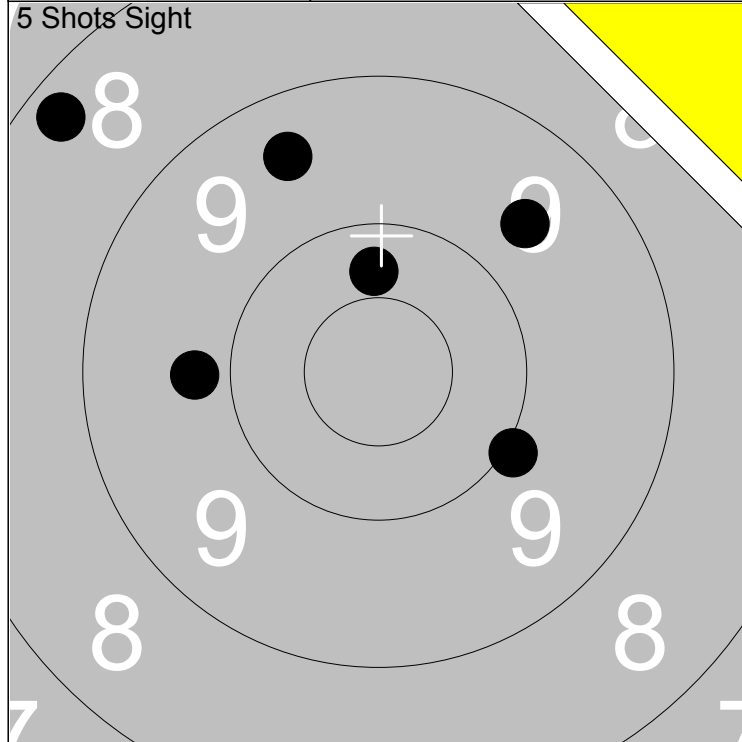

1: 9.6 ↗	6: 8.3 ↖	Series 62.0
2: 7.7 ↗	7: 10.3 ↑	
3: 10.0 ↘		Total 274.0
4: 9.4 ↑		
5: 9.8 ←		

1: 9.8 ↖	Series 47.0
2: 10.3 ↘	
3: 10.3 ↓	Total 321.0
4: 9.6 →	
5: 9.6 ↓	

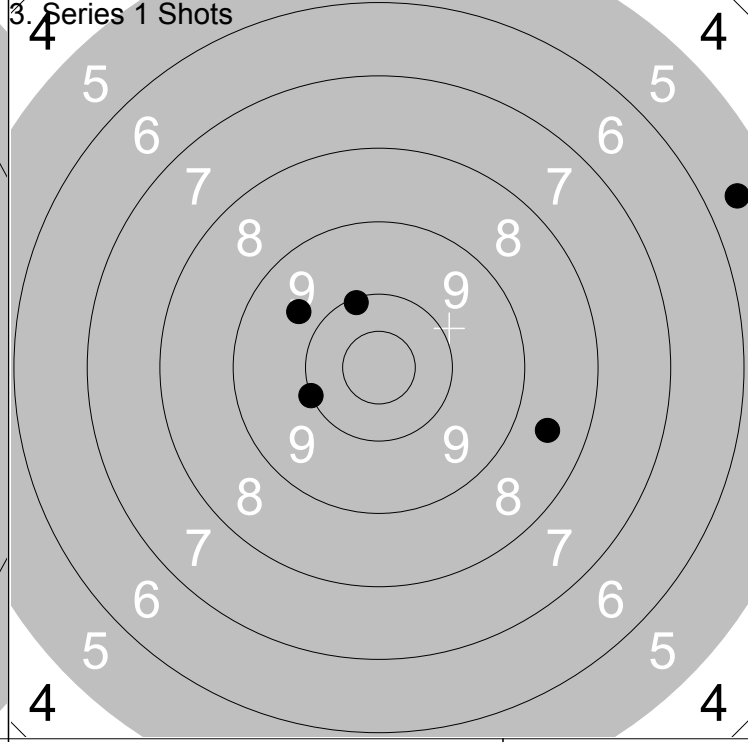
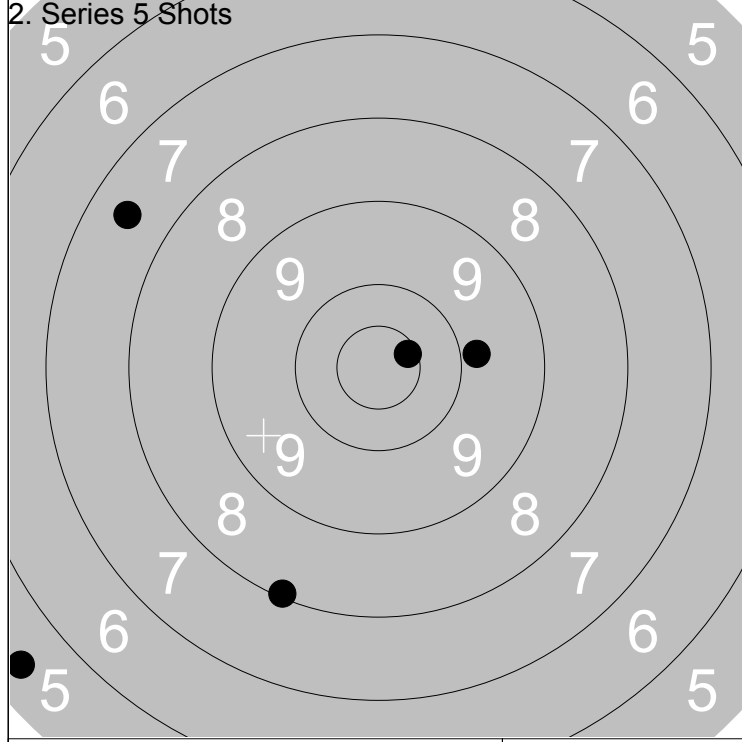

1: 7.5 ↖	Series 39.0
2: 5.4 ↙	
3: 9.8 →	Total 360.0
4: 8.1 ↓	
5: *10.6 ↗	

1: 9.7 ↖	Series 42.0
2: 8.6 →	
3: 10.0 ↙	Total 402.0
4: 10.1 ↑	
5: 5.6 ↗	

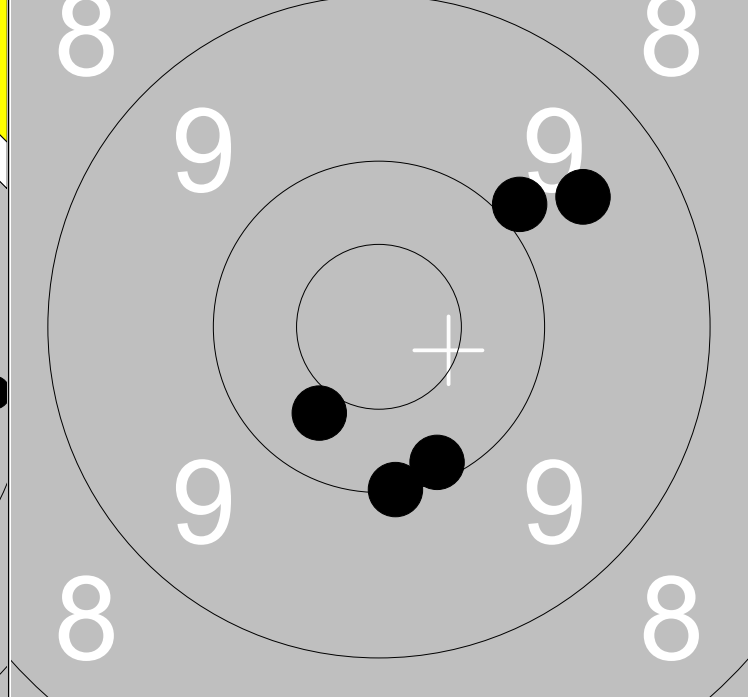
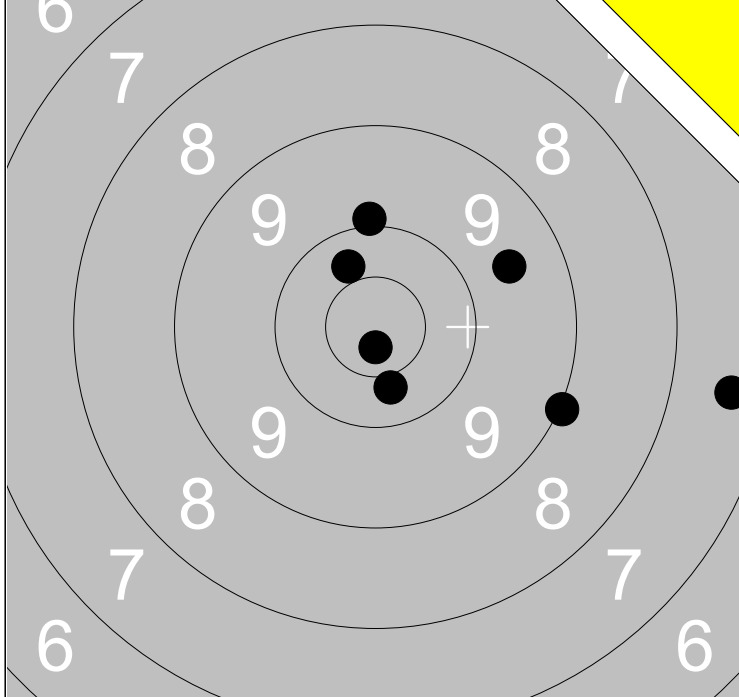

1: *10.8 ↓	6: 9.0 →	Series	64.0
2: 9.6 →	7: 7.4 →		
3: 10.4 ↓		Total	271.0
4: 10.3 ↑			
5: 9.9 ↑			

1: 9.6 ↗	Series	48.0
2: 10.1 ↓		
3: 10.0 ↓	Total	319.0
4: 9.9 ↗		
5: 10.4 ↓		

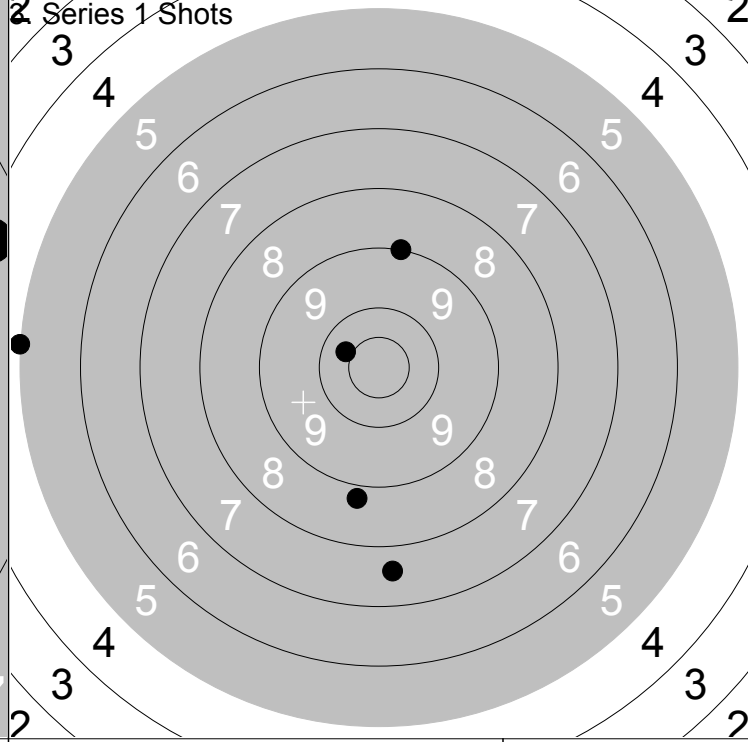
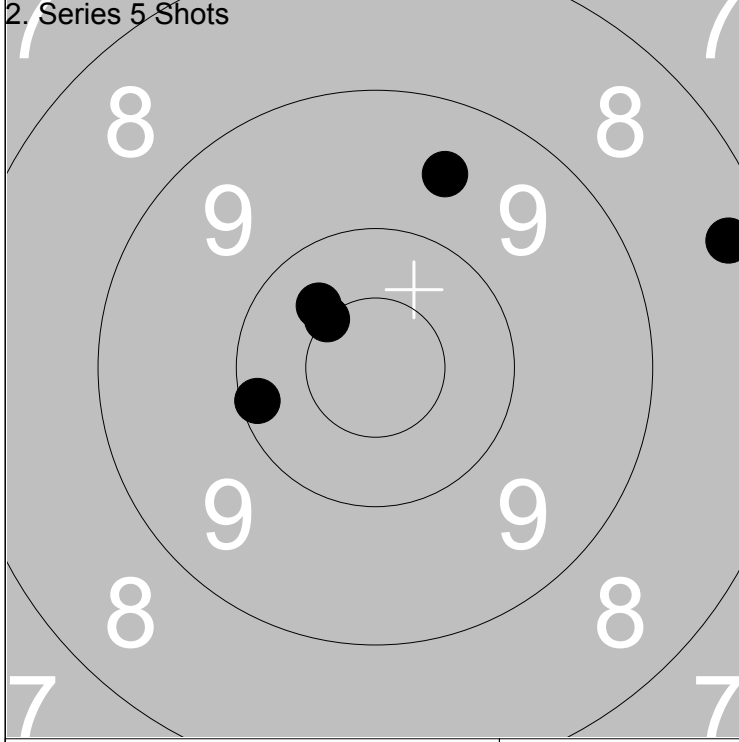

1: 10.4 ↖	Series	47.0
2: 10.1 ←		
3: *10.5 ↖	Total	366.0
4: 9.5 ↑		
5: 8.3 →		

1: 10.4 ↖	Series	39.0
2: 5.0 ←		
3: 8.8 ↓	Total	405.0
4: 9.0 ↑		
5: 7.6 ↓		

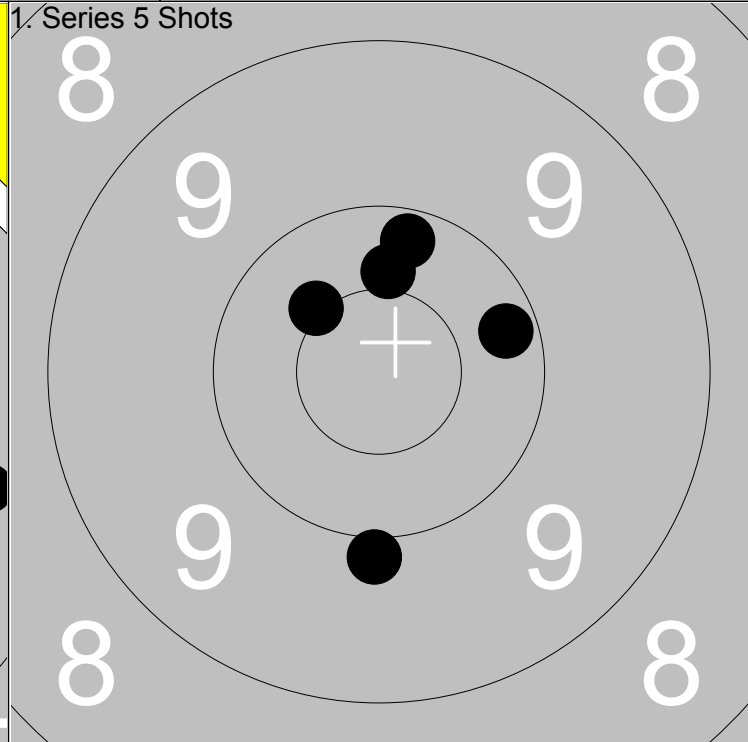
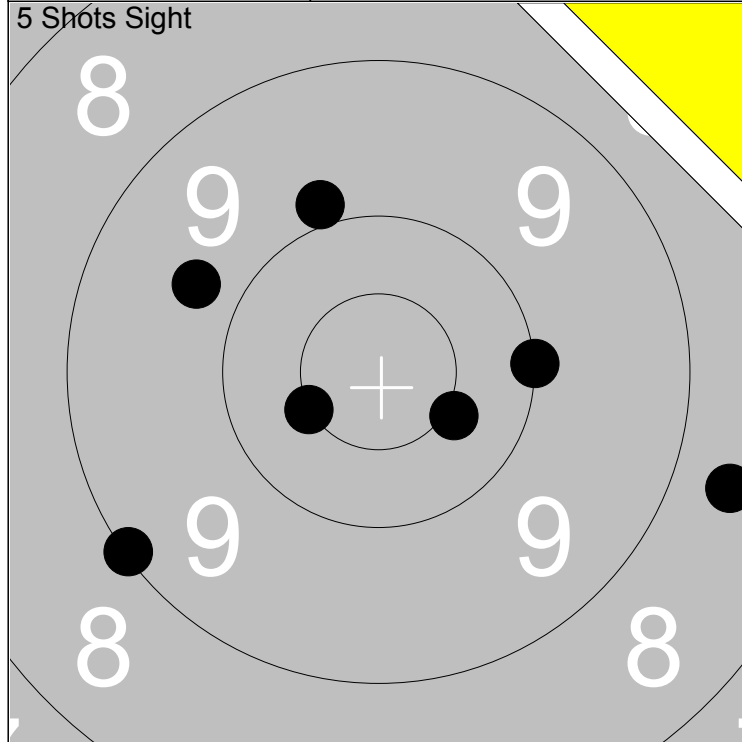

1: 8.7 →	6: 9.1 ↙	Series 65.0	
2: 10.0 →	7: *10.5 ↙		
3: 9.9 ↑		Total 270.0	
4: 9.7 ↖			
5: *10.4 ↘			

1: *10.4 ↖	Series 49.0		
2: 10.2 →			
3: 10.4 ↑	Total 319.0		
4: 10.2 ↑			
5: 9.9 ↓			

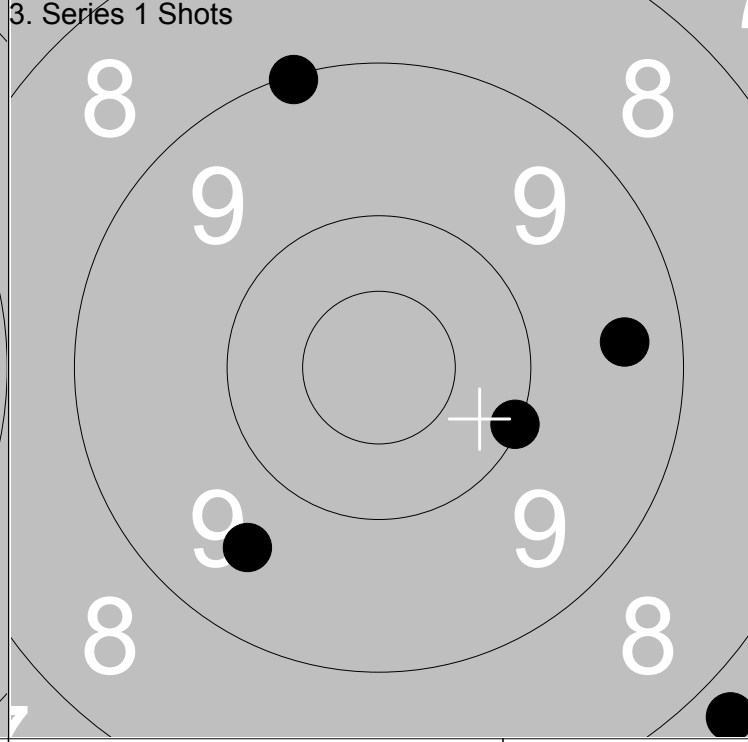
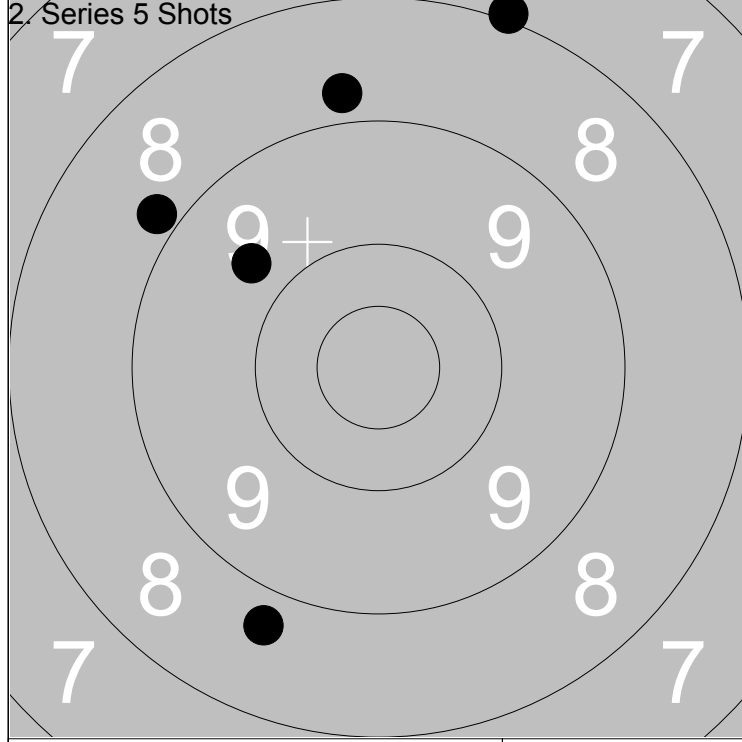

1: 8.0 ↑	Series 41.0		
2: 8.8 ↑			
3: 9.7 ↖	Total 360.0		
4: 8.8 ↖			
5: 8.7 ↓			

1: 9.1 ↑	Series 44.0		
2: 9.4 →			
3: 9.6 ↙	Total 404.0		
4: 7.8 ↘			
5: 10.1 ↘			

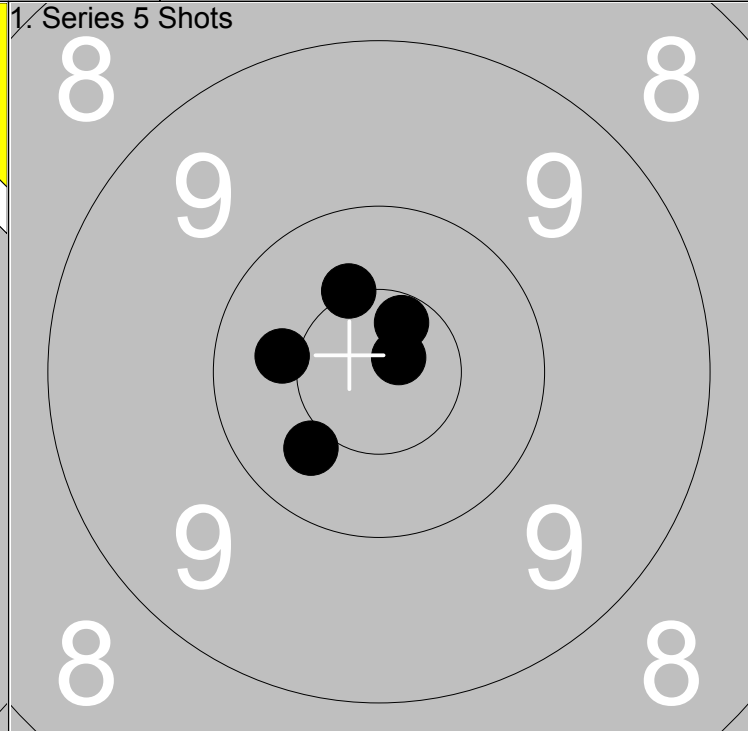
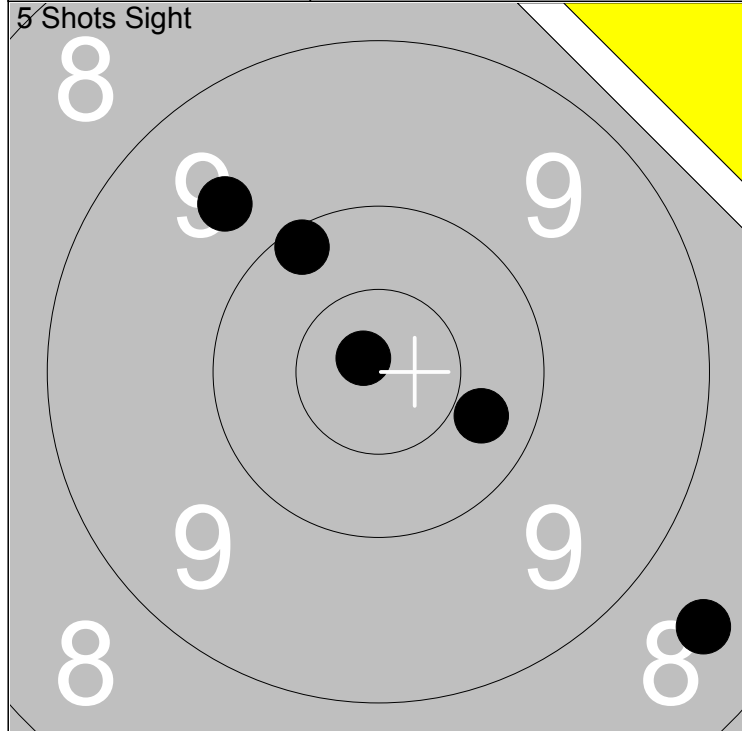

1: 10.3 →	Series	47.0
2: 10.1 ↗		
3: 9.7 ↗	Total	283.0
4: 8.5 ↘		
5: *10.8 ↖		

1: 10.4 ←	Series	50.0
2: *10.8 ↗		
3: 10.4 ↘	Total	333.0
4: *10.6 ↗		
5: *10.5 ↖		

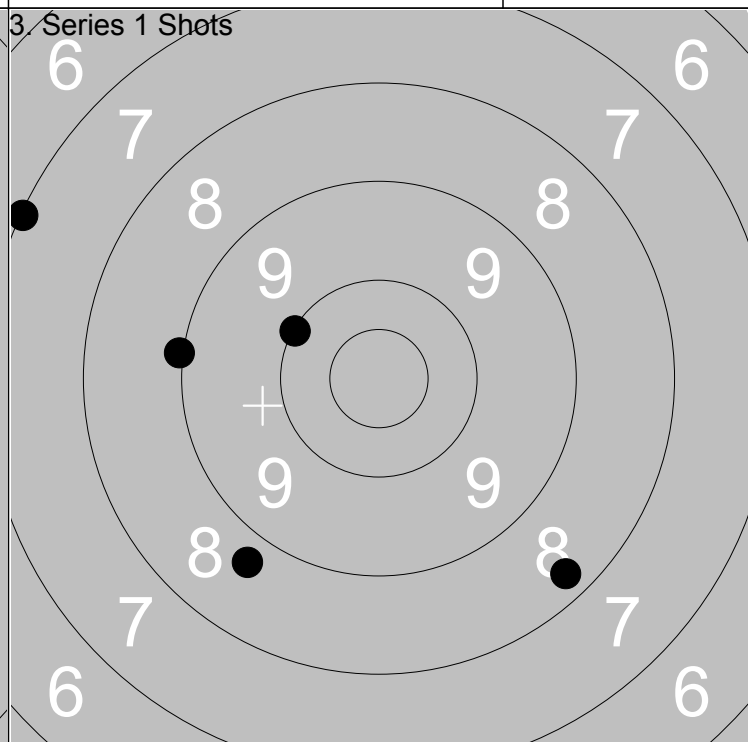
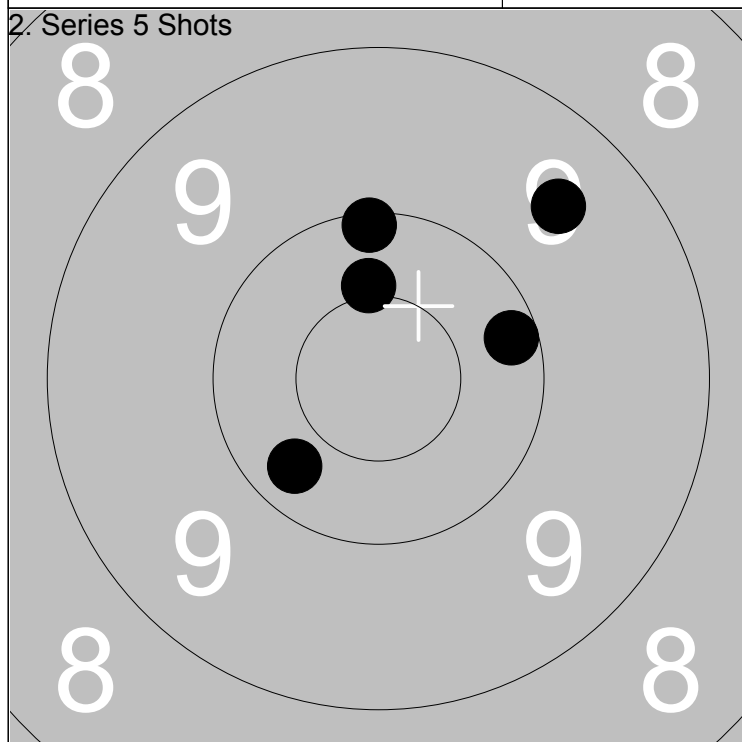

1: 10.1 ↑	Series	49.0
2: 10.2 →		
3: *10.4 ↑	Total	382.0
4: 10.3 ↘		
5: 9.5 ↗		

1: 8.7 ↘	Series	42.0
2: 7.1 ←		
3: 9.0 ←	Total	424.0
4: 10.0 ←		
5: 8.3 ↘		