

	1:	8.7			↓
	2:	10.0			→
	3:	10.4			↘
Series					28.0
Total					233.0

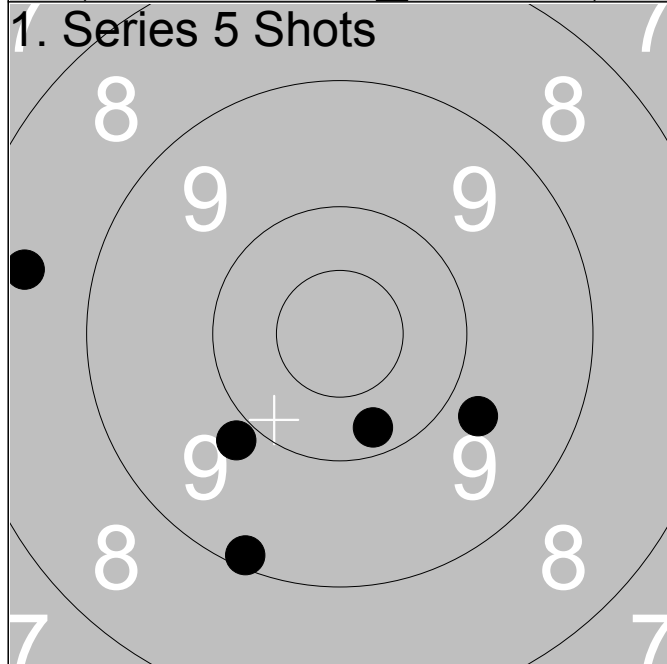

	1:	10.2			↓
	2:	9.8			↘
	3:	9.1			↓
	4:	9.9			↙
	5:	8.5			←
Series					45.0
Total					278.0

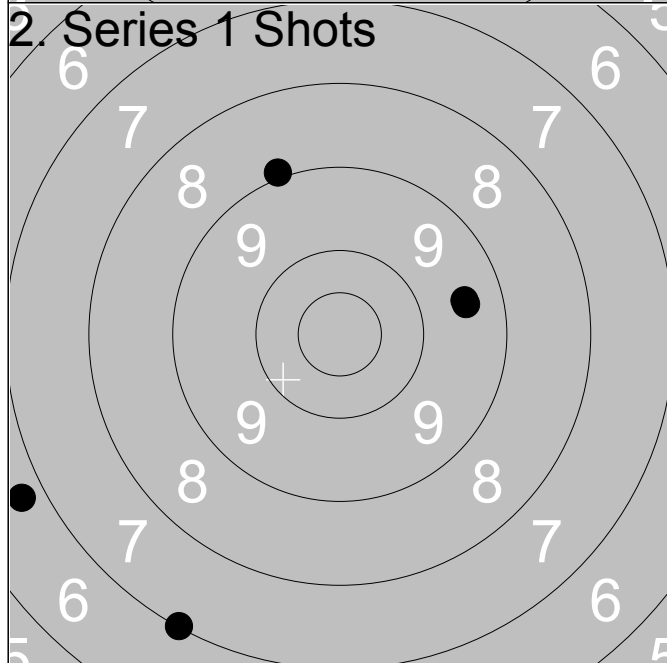

	1:	9.5			→
	2:	9.5			→
	3:	6.7			↙
	4:	9.0			↑
	5:	7.0			↘
Series					40.0
Total					318.0

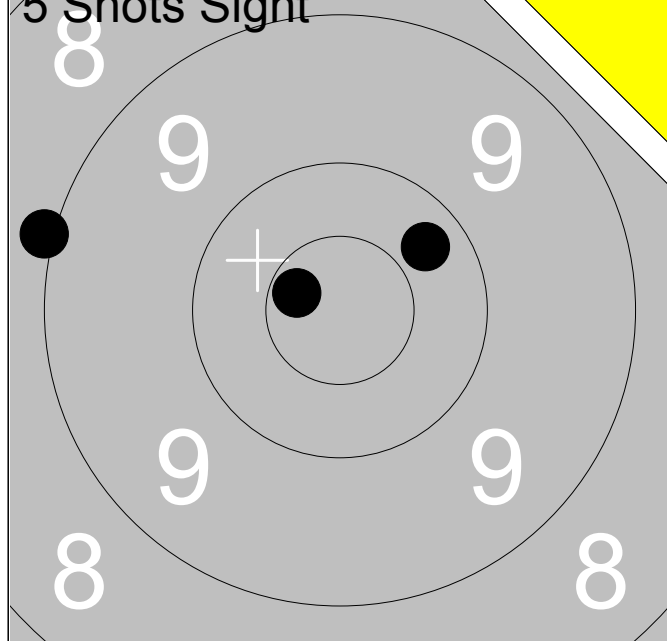

1:	9.0	←
2:	*10.7	←
3:	10.3	↗
Series		29.0
Total		231.0

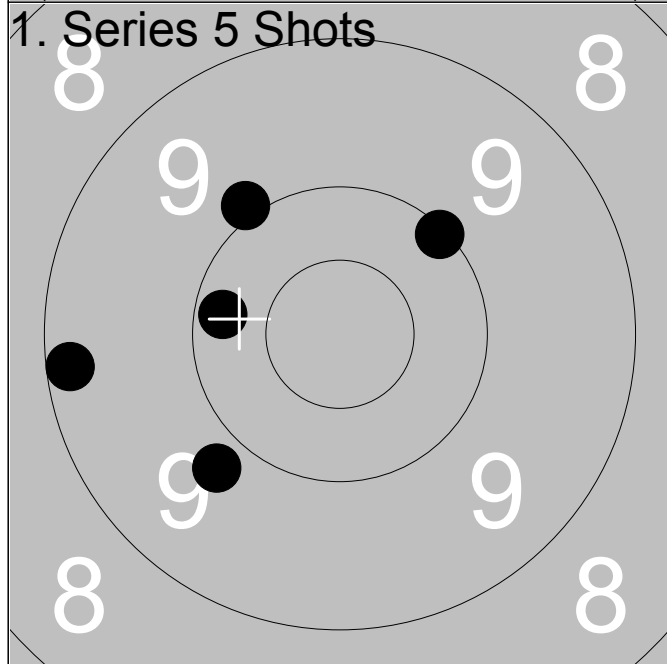

1:	9.2	←
2:	10.2	←
3:	10.1	↗
4:	10.0	↖
5:	9.8	↙
Series		48.0
Total		279.0

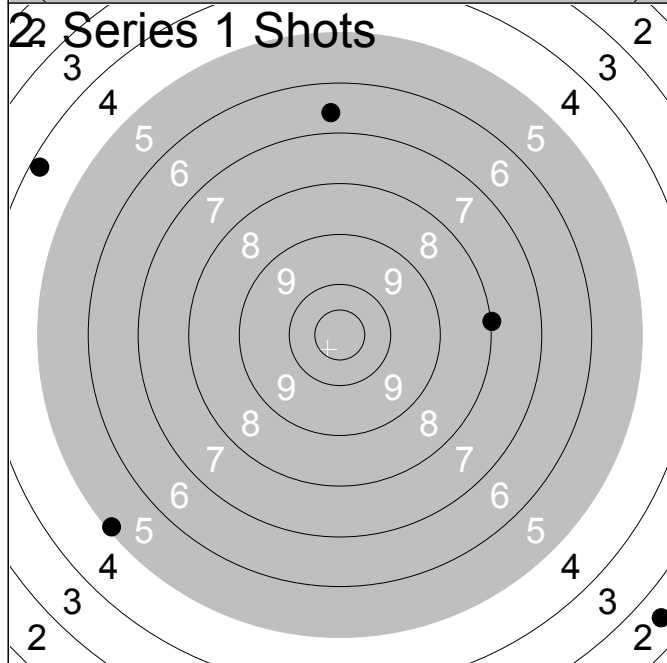

1:	4.2	←
2:	8.0	→
3:	2.5	↘
4:	6.6	↑
5:	5.1	↙
Series		25.0
Total		304.0

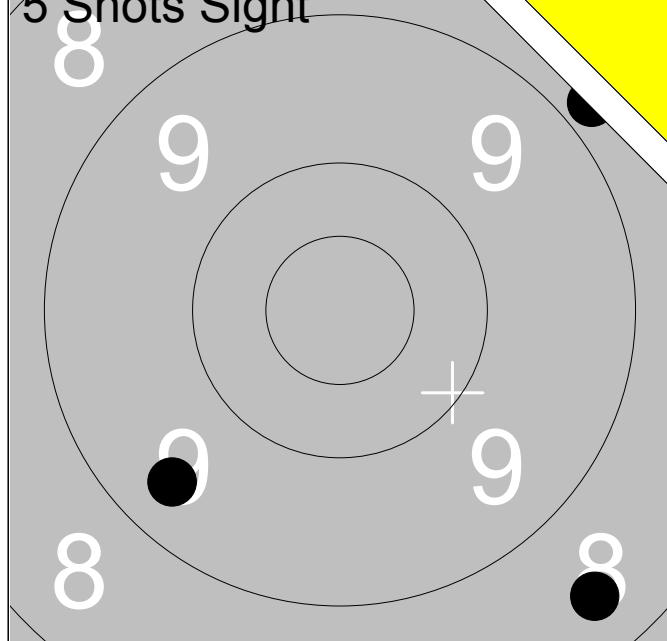

	1:	8.4	↘
	2:	9.4	↙
	3:	8.8	↗
Series			25.0
Total			227.0

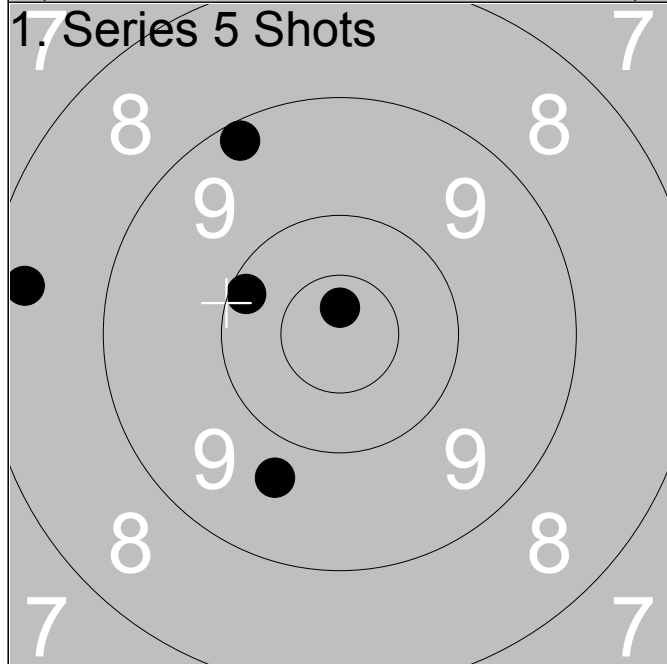

	1:	9.7	↙
	2:	9.2	↗
	3:	10.2	↖
	4:	8.3	←
	5:	*10.7	↑
Series			46.0
Total			273.0

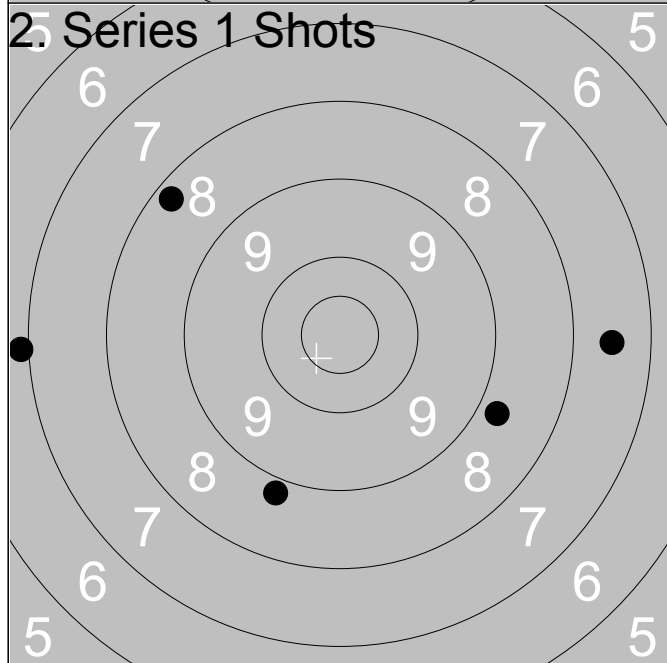

	1:	8.8	↙
	2:	8.8	↘
	3:	8.2	↗
	4:	7.5	→
	5:	6.9	←
Series			37.0
Total			310.0

Relay 4	Lane 4	Berndt Steffen		
-------------------	------------------	-----------------------	--	--

300m	Frötuna	Vet	St
------	---------	-----	----

05.07.2014	Björskottet 2014-07-05	Ramselefors SKF
------------	------------------------	-----------------



1:	9.7	↘
2:	9.8	↑
3:	10.0	↗
Series	28.0	
Total	227.0	

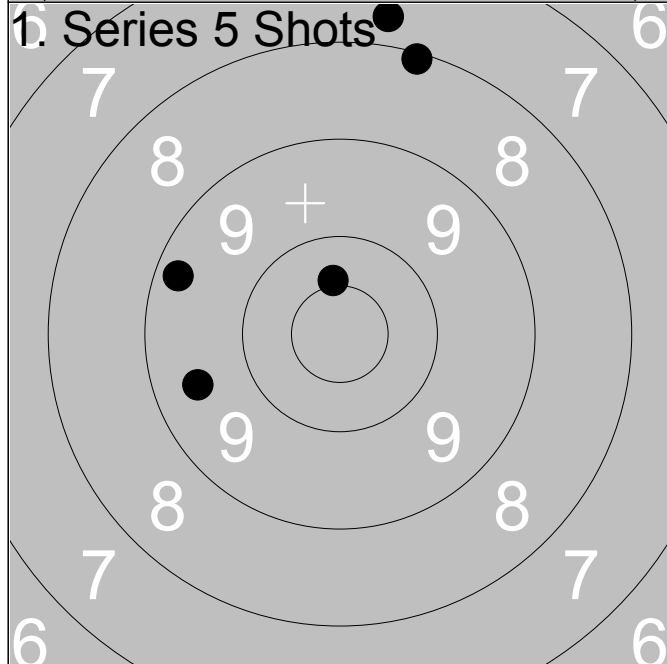

1:	*10.4	↑
2:	7.7	↑
3:	9.3	↖
4:	8.1	↑
5:	9.5	↖
Series	43.0	
Total	270.0	

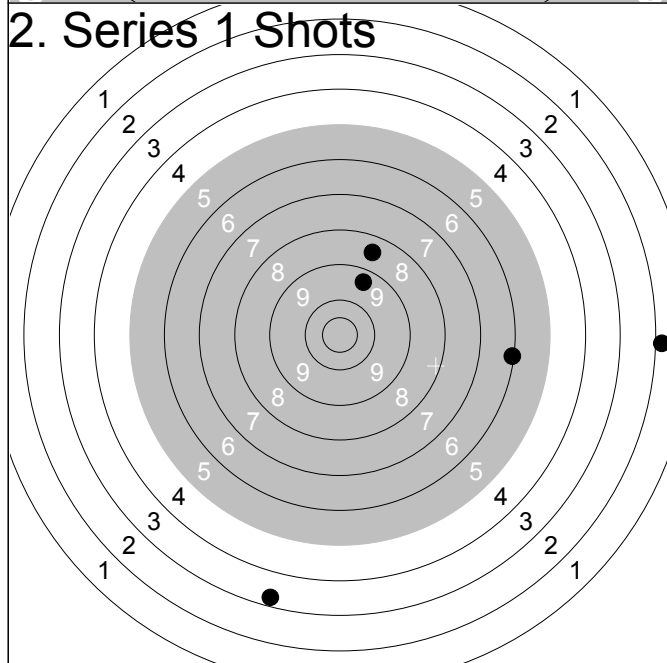

1:	6.1	→
2:	1.8	→
3:	9.4	↗
4:	3.3	↘
5:	8.5	↗
Series	27.0	
Total	297.0	



	1:	10.3	→
	2:	*10.5	→
	3:	6.8	←
Series			26.0
Total			226.0

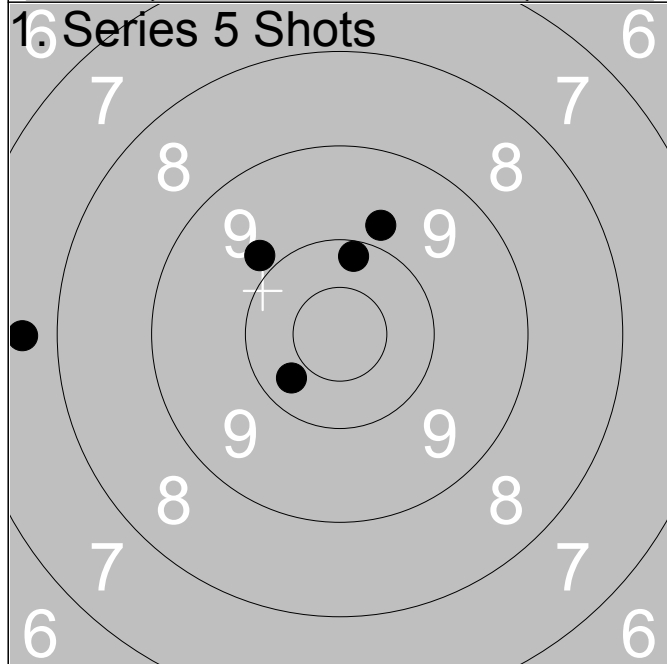

	1:	9.8	↖
	2:	9.8	↑
	3:	10.2	↑
	4:	10.3	↙
	5:	7.7	←
Series			45.0
Total			271.0

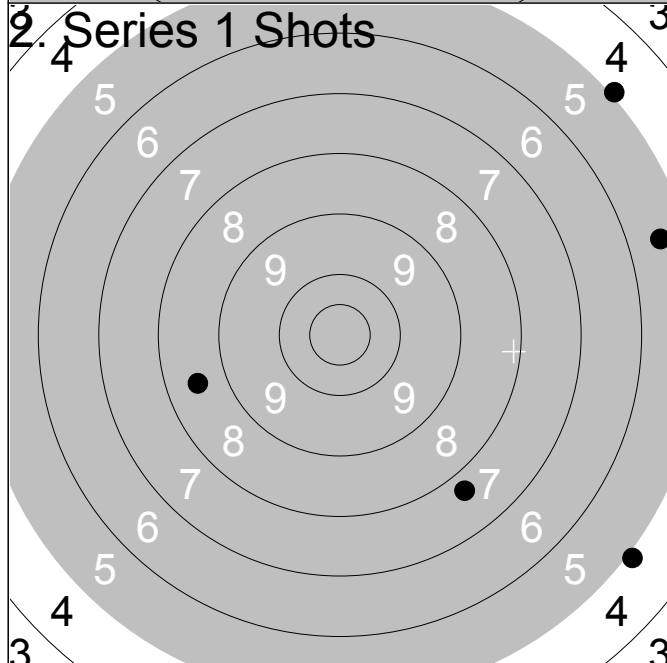

	1:	7.7	↘
	2:	5.5	→
	3:	8.5	←
	4:	5.0	↗
	5:	4.9	↘
Series			29.0
Total			300.0



	1:	10.2	↑
	2:	7.7	→
	3:	6.5	↗
Series			23.0
Total			224.0

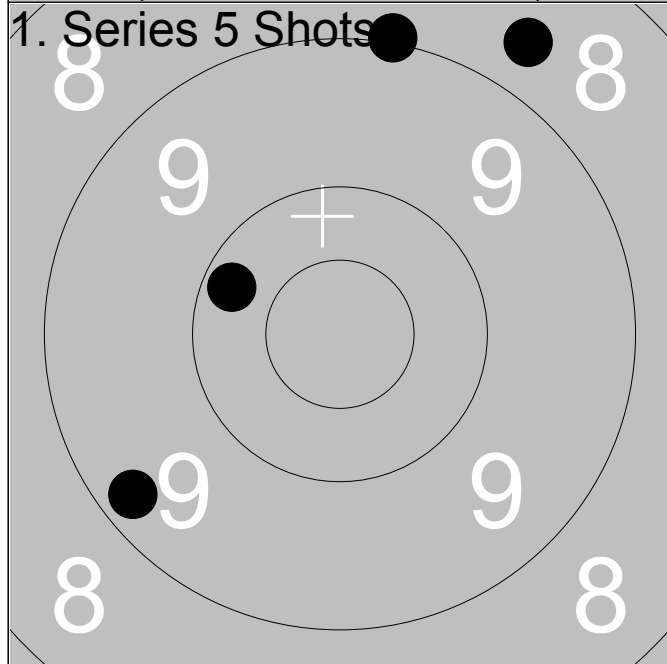

	1:	0.0	
	2:	9.3	↙
	3:	8.7	↗
	4:	9.0	↑
	5:	10.2	↙
Series			36.0
Total			260.0

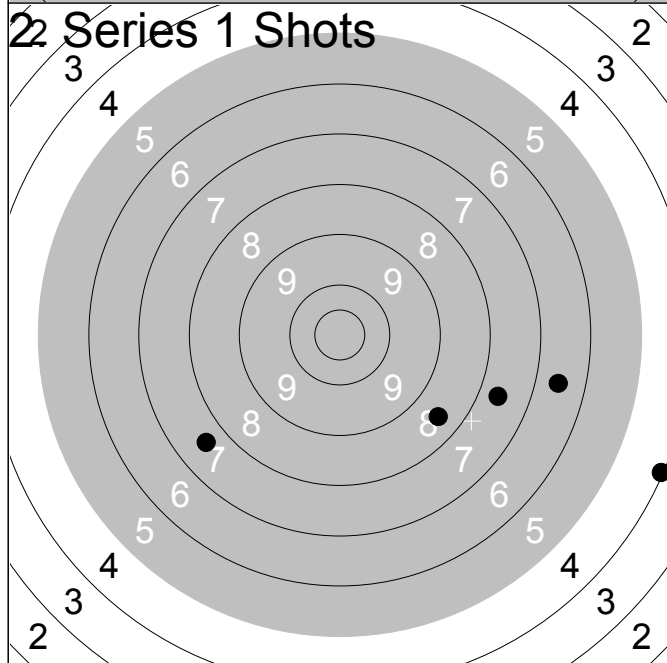

	1:	6.6	→
	2:	7.6	↙
	3:	8.5	↘
	4:	7.7	→
	5:	4.1	→
Series			32.0
Total			292.0

Relay 4	Lane 7	Jan-Erik Karlsson		
-------------------	------------------	--------------------------	--	--

300m	Ramselefors	Vet	Vb
------	-------------	-----	----

05.07.2014	Björkskottet 2014-07-05	Ramselefors SKF
------------	-------------------------	-----------------



1:	7.9	←
2:	9.0	↗
3:	9.7	↓
Series	25.0	
Total	212.0	

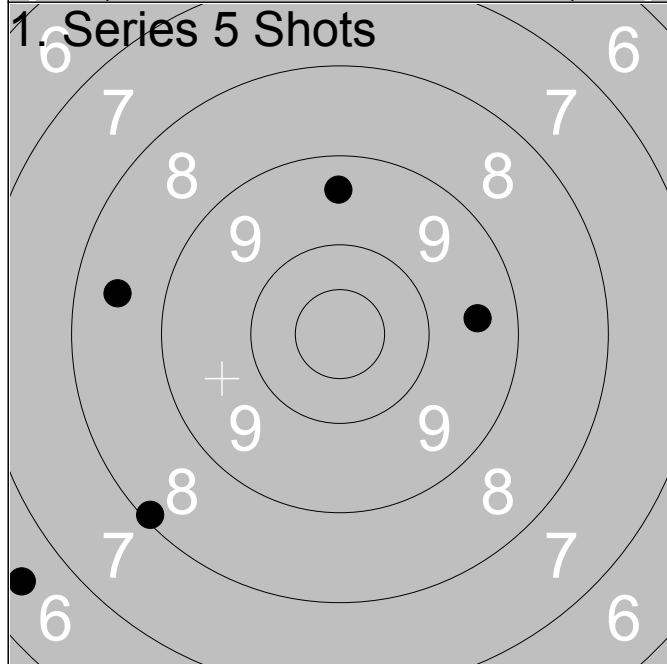

1:	9.4	↑
2:	8.5	←
3:	9.5	→
4:	8.1	↙
5:	6.5	↙
Series	40.0	
Total	252.0	

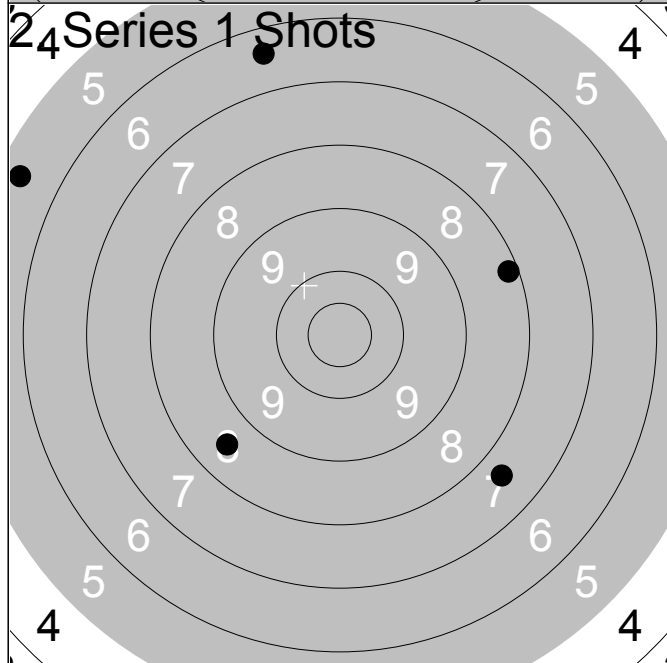

1:	8.5	↙
2:	5.4	↖
3:	7.6	↘
4:	6.4	↑
5:	8.2	↗
Series	34.0	
Total	286.0	

Relay 4	Lane 8	Alf Edin
-------------------	------------------	-----------------

300m	Ale	Vet	No
------	-----	-----	----

05.07.2014	Björskottet 2014-07-05	Ramselefors SKF
------------	------------------------	-----------------



1:	9.8	→
2:	8.8	↗
3:	9.2	↖
Series	26.0	
Total	209.0	

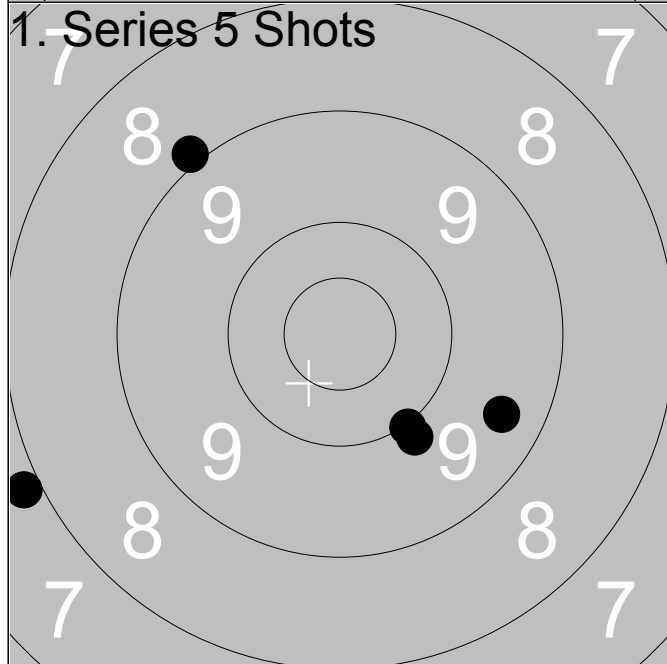

1:	8.9	↗
2:	10.0	↘
3:	9.4	↘
4:	7.9	↖
5:	9.9	↘
Series	43.0	
Total	252.0	

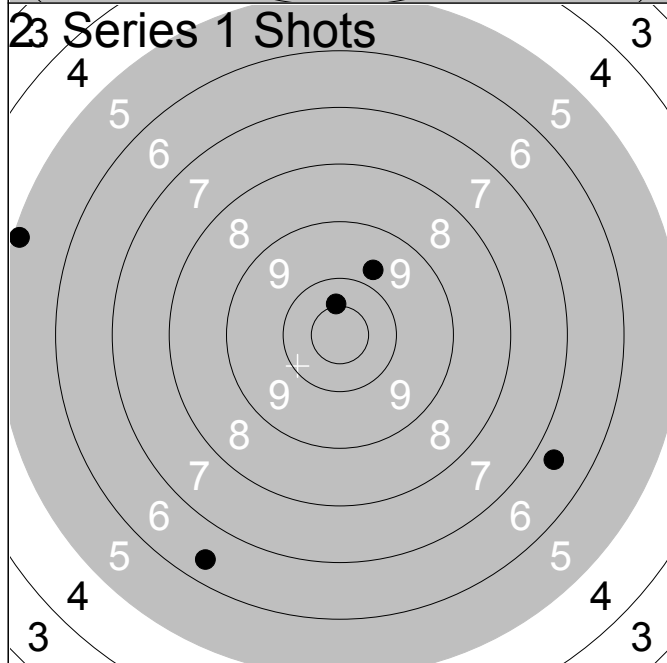

1:	6.4	↘
2:	*10.4	↑
3:	5.1	↖
4:	9.7	↗
5:	6.7	↘
Series	36.0	
Total	288.0	

Relay 4	Lane 9	Tony Jansson
-------------------	------------------	---------------------

300m	Ununge	Vet	St
------	--------	-----	----

05.07.2014	Björkskottet 2014-07-05	Ramselefors SKF
------------	-------------------------	-----------------



1:	6.9	↑
2:	8.6	↗
3:	8.3	↘

Series	22.0
Total	209.0

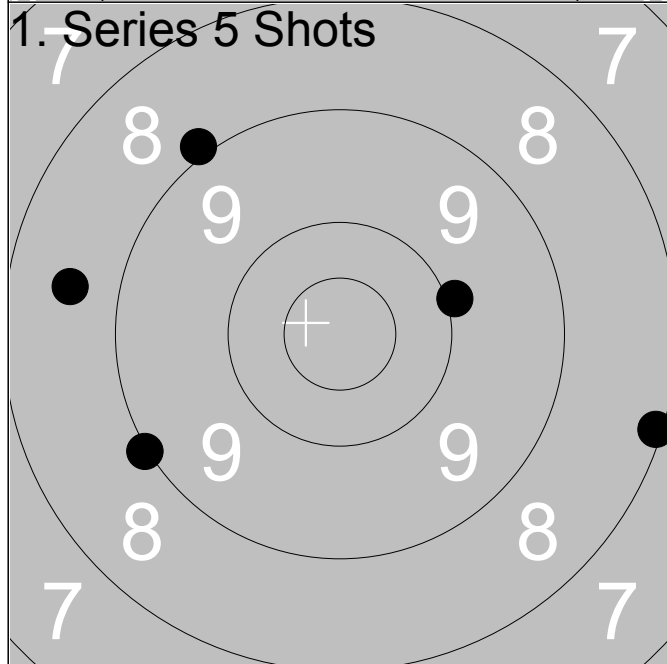

1:	8.9	↖
2:	10.0	→
3:	8.1	→
4:	9.0	↙
5:	8.6	↙

Series	43.0
Total	252.0

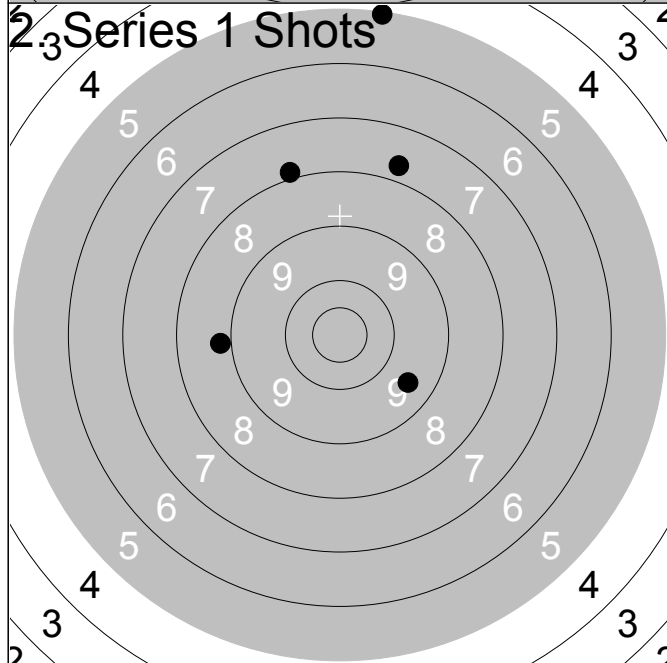

1:	7.9	↑
2:	8.8	←
3:	9.5	↘
4:	7.7	↑
5:	5.1	↑

Series	36.0
Total	288.0

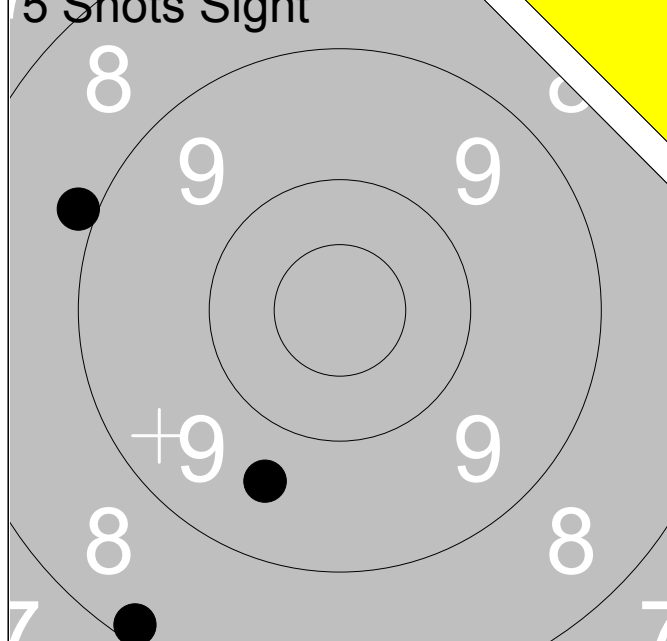

1:	8.2	↙
2:	9.6	↙
3:	8.9	↘
Series	25.0	
Total	206.0	

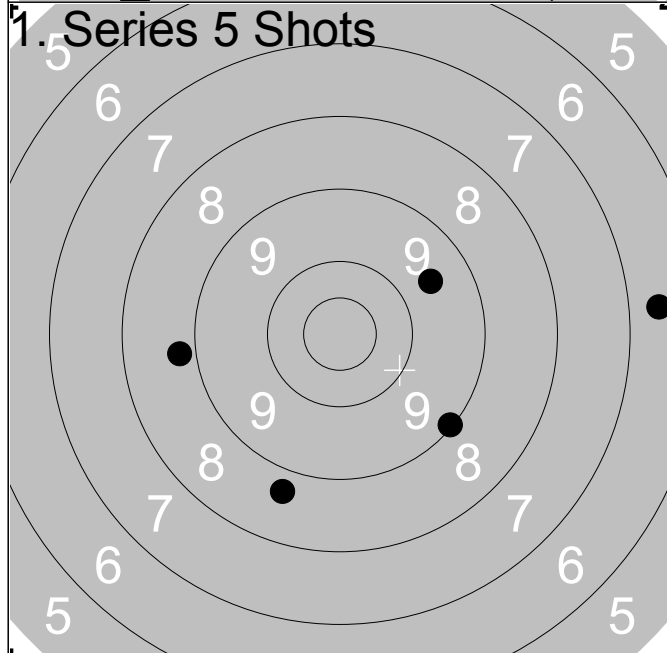

1:	9.6	↗
2:	8.7	↙
3:	9.1	↘
4:	8.8	←
5:	6.6	→
Series	40.0	
Total	246.0	

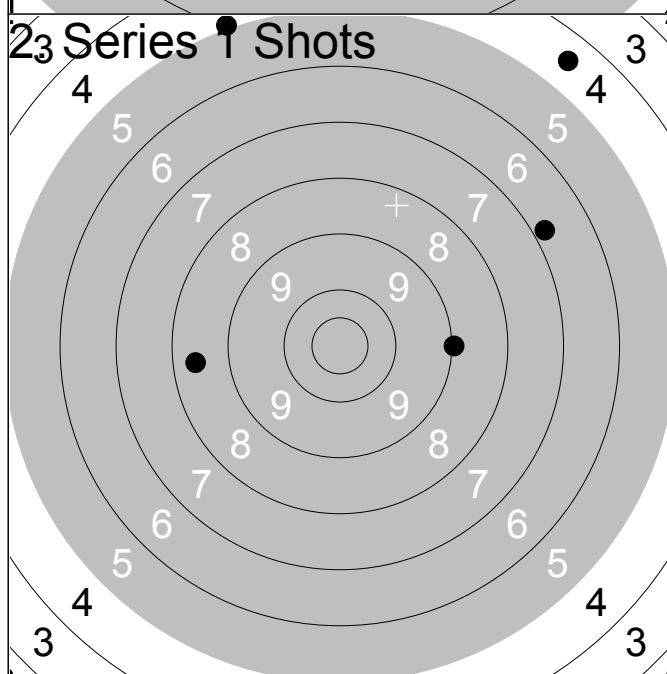

1:	4.5	↗
2:	6.8	↗
3:	4.9	↑
4:	8.4	←
5:	9.0	→
Series	31.0	
Total	277.0	

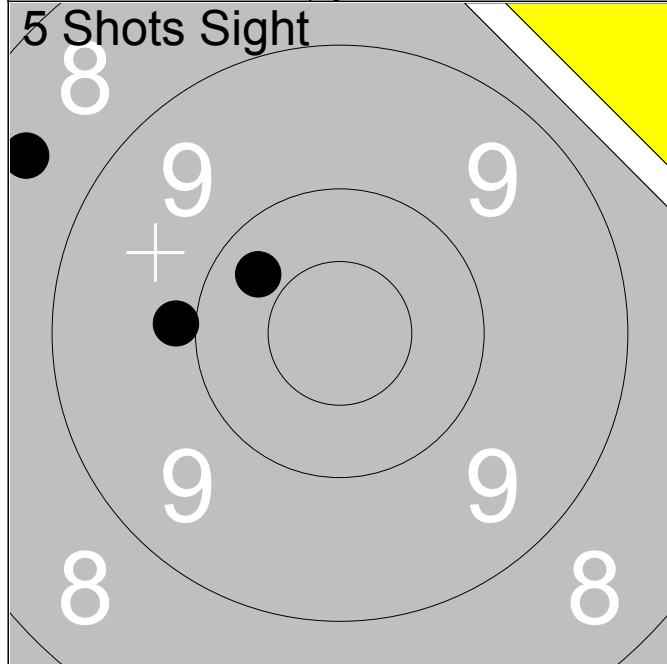

	1:	8.5	↗
	2:	9.9	↖
	3:	10.3	↗
Series			27.0
Total			245.0

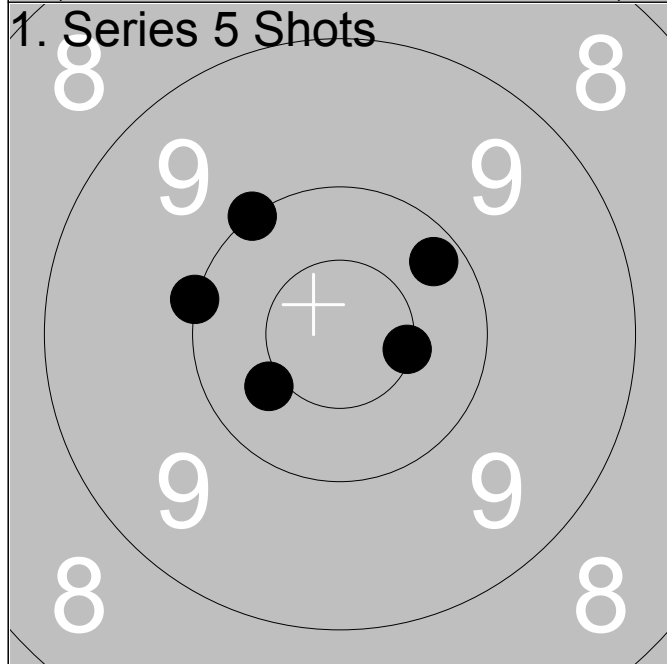

	1:	10.0	↖
	2:	10.2	↗
	3:	*10.5	→
	4:	10.0	↗
	5:	10.4	↙
Series			50.0
Total			295.0

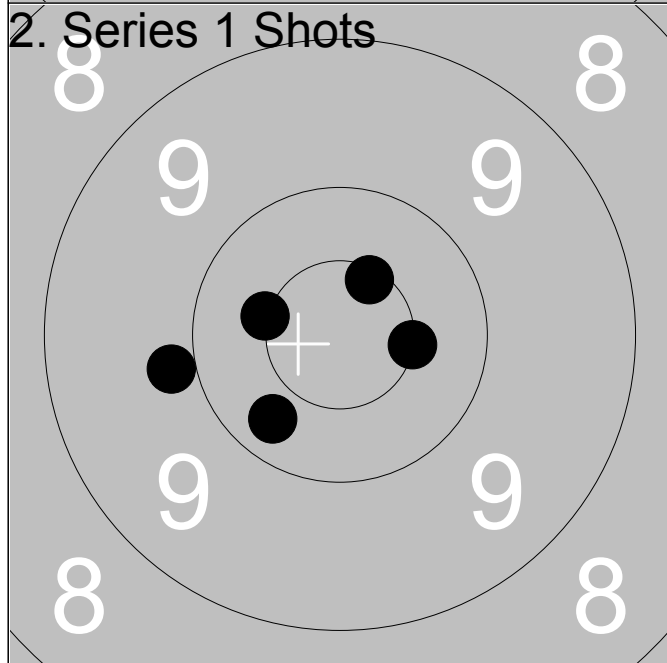

	1:	10.3	↙
	2:	*10.5	→
	3:	9.9	↖
	4:	*10.5	↖
	5:	*10.6	↗
Series			49.0
Total			344.0

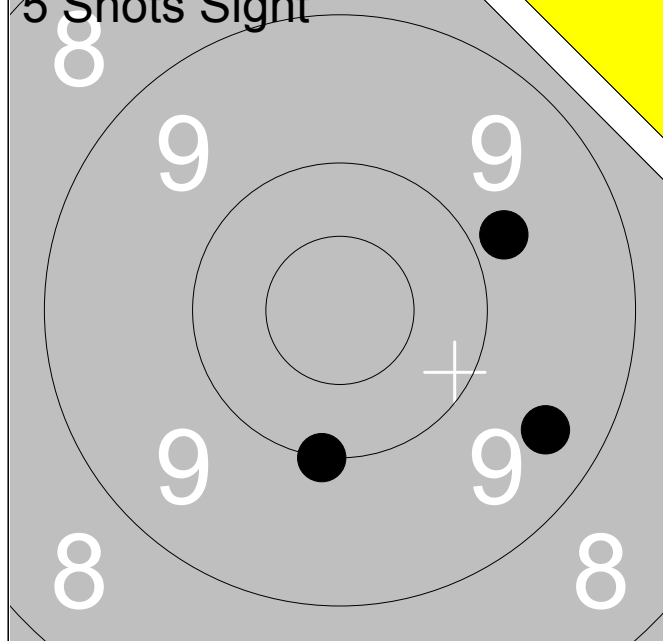

	1:	9.4			↘
	2:	9.8			→
	3:	10.0			↓
Series					28.0
Total					241.0

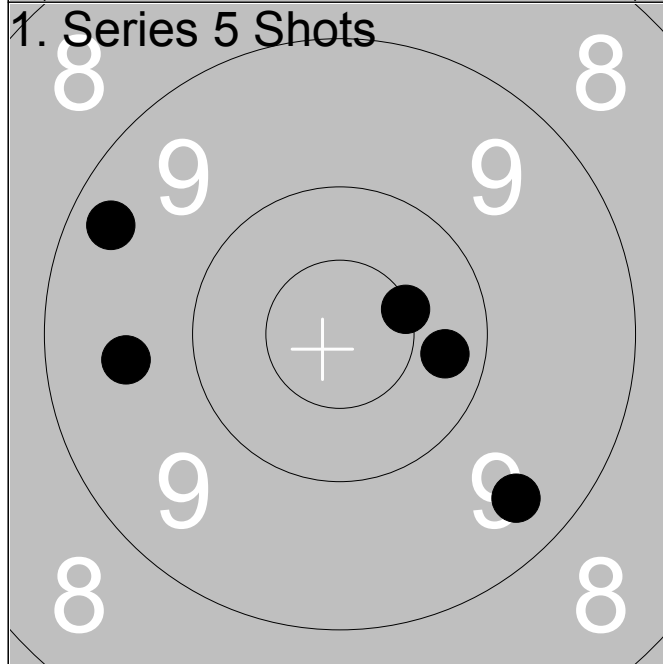

	1:	9.6			←
	2:	10.3			→
	3:	*10.5			→
	4:	9.3			↖
	5:	9.4			↘
Series					47.0
Total					288.0

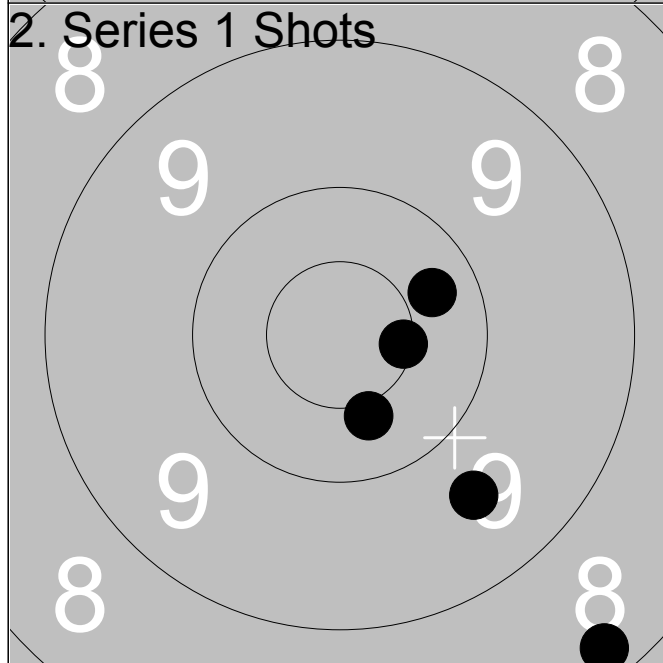

	1:	10.3			→
	2:	*10.5			→
	3:	10.4			↘
	4:	8.2			↘
	5:	9.6			↘
Series					47.0
Total					335.0

Relay 4	Lane 14	Victor Isaksson
-------------------	-------------------	------------------------

300m	Loos	Ligg	Gä
------	------	------	----

05.07.2014	Björskottet 2014-07-05	Ramselefors SKF
------------	------------------------	-----------------

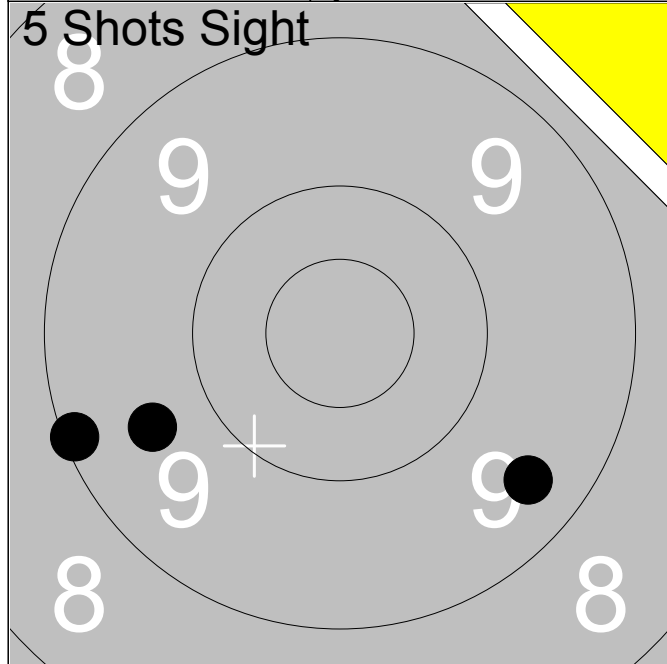

1:	9.6	↙
2:	9.1	↙
3:	9.4	↘

Series	27.0
Total	234.0

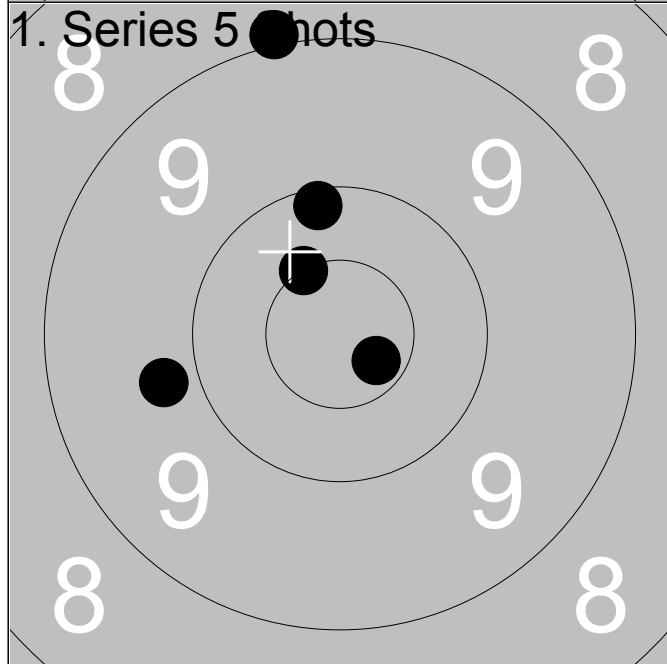

1:	9.0	↑
2:	*10.5	↗
3:	10.1	↑
4:	9.8	↙
5:	*10.7	↘

Series	48.0
Total	282.0

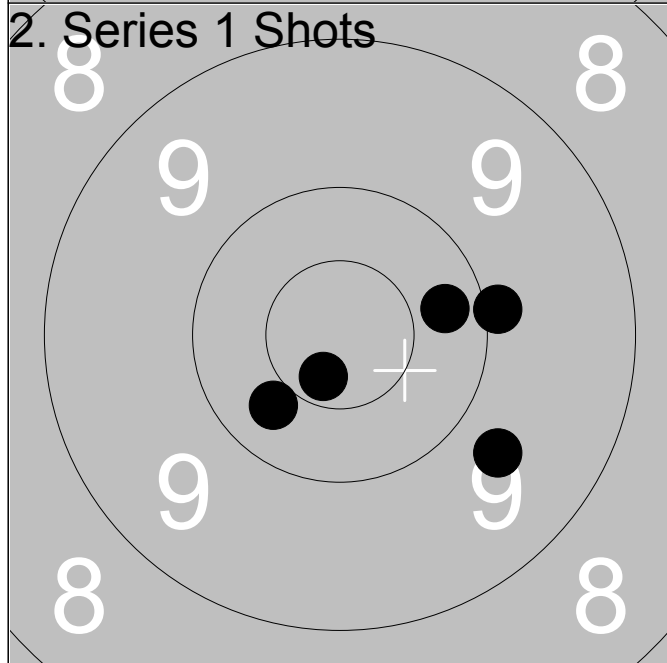

1:	9.7	↘
2:	9.9	→
3:	*10.7	↘
4:	10.3	↙
5:	10.3	→

Series	48.0
Total	330.0

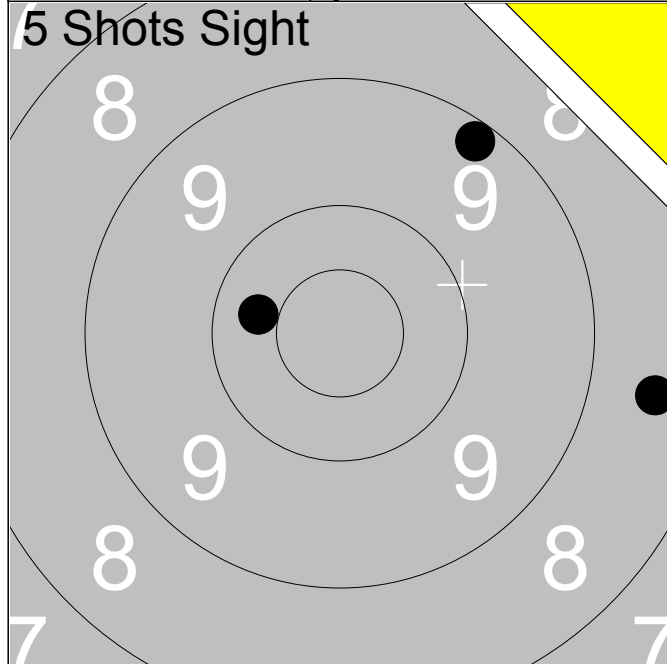

1:	9.2	↗
2:	8.5	→
3:	10.3	↖

Series	27.0
Total	231.0

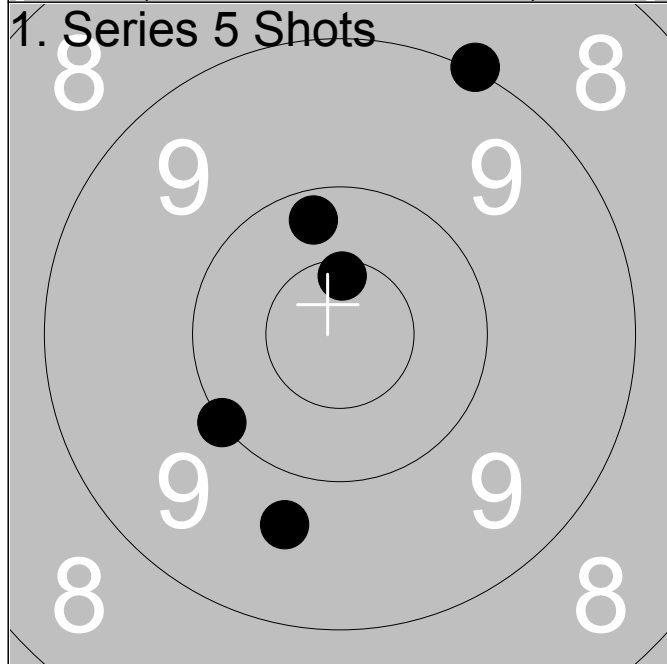

1:	9.0	↗
2:	10.2	↑
3:	9.7	↓
4:	10.0	↖
5:	*10.6	↑

Series	48.0
Total	279.0

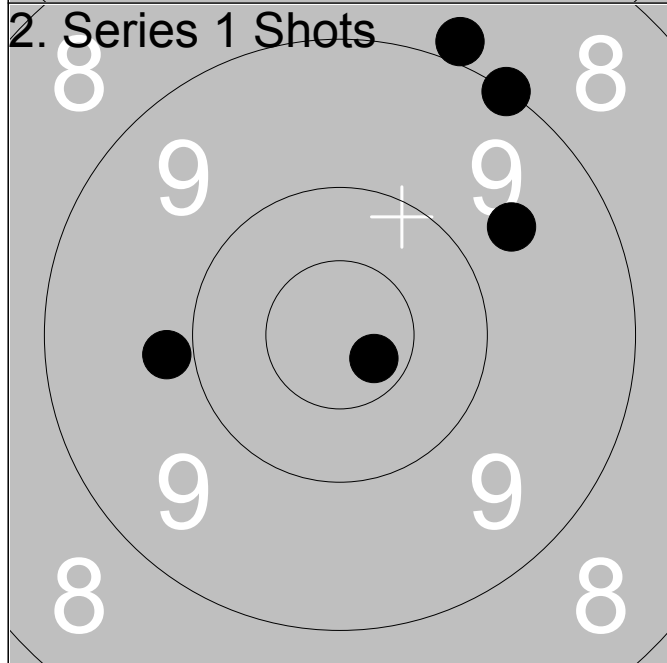

1:	8.9	↗
2:	*10.7	↘
3:	9.7	↗
4:	9.9	↖
5:	9.0	↗

Series	45.0
Total	324.0



1:	10.1	←
2:	*10.5	↗
3:	8.9	↘

Series	28.0
Total	231.0

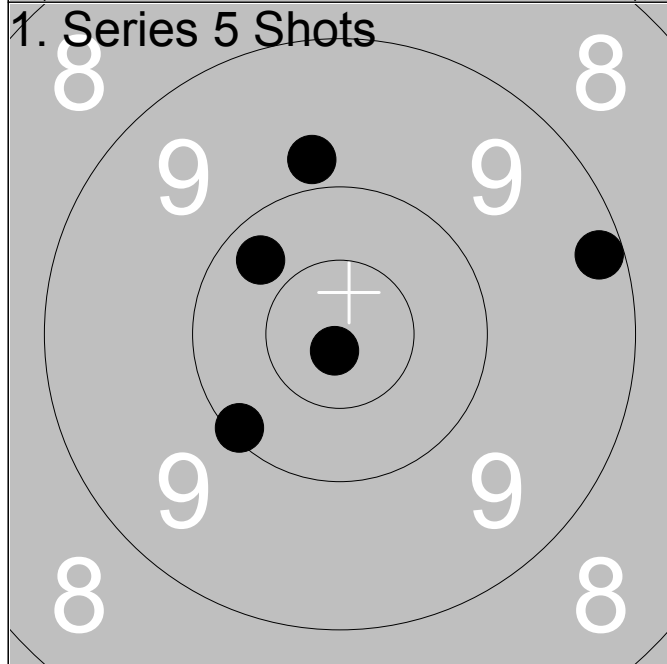

1:	10.3	↖
2:	9.8	↑
3:	10.1	↙
4:	9.2	→
5:	*10.8	↘

Series	48.0
Total	279.0

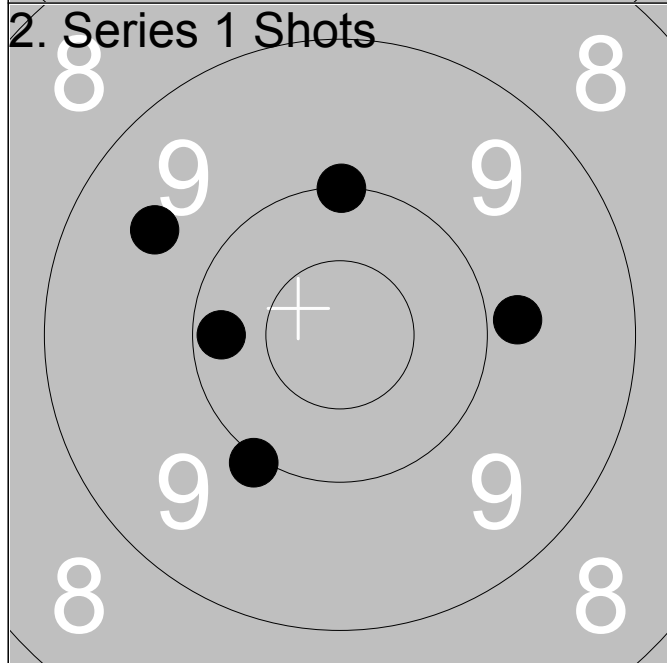

1:	10.0	↙
2:	10.0	↑
3:	9.8	→
4:	9.6	↖
5:	10.2	←

Series	48.0
Total	327.0

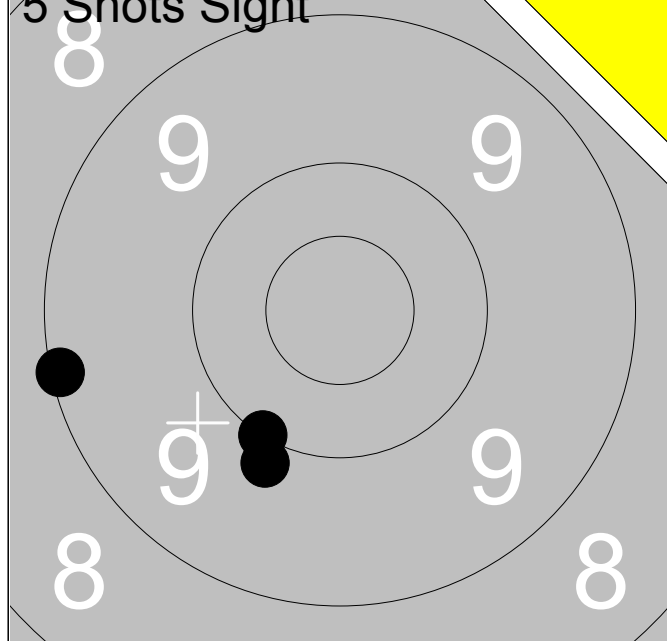

	1:	9.1	←
	2:	9.9	↙
	3:	10.0	↘
Series			28.0
Total			227.0

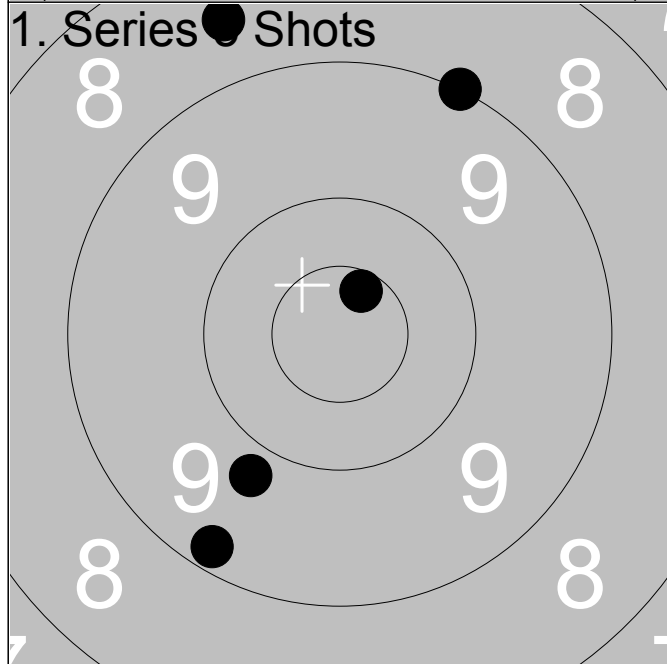

	1:	8.6	↖
	2:	9.0	↗
	3:	9.8	↘
	4:	*10.6	↗
	5:	9.2	↘
Series			45.0
Total			272.0

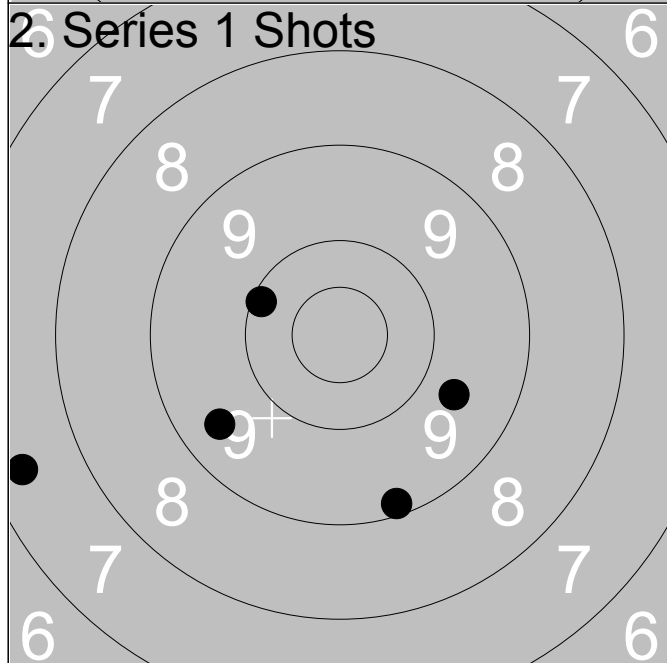

	1:	9.2	↘
	2:	10.1	↖
	3:	7.4	↖
	4:	9.5	↘
	5:	9.7	↗
Series			44.0
Total			316.0



1:	8.6	→
2:	10.4	↖
3:	8.2	↘
Series		26.0
Total		226.0

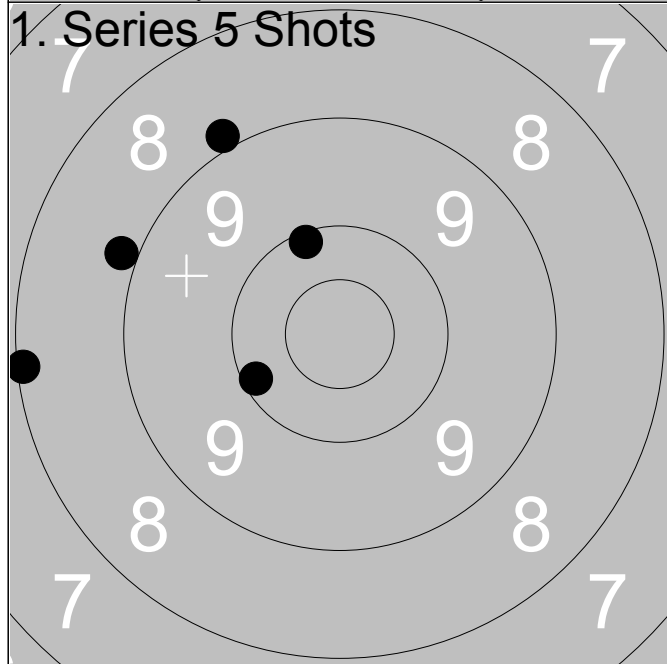

1:	8.9	↖
2:	10.1	↖
3:	8.9	↖
4:	8.1	←
5:	10.1	↙
Series		44.0
Total		270.0

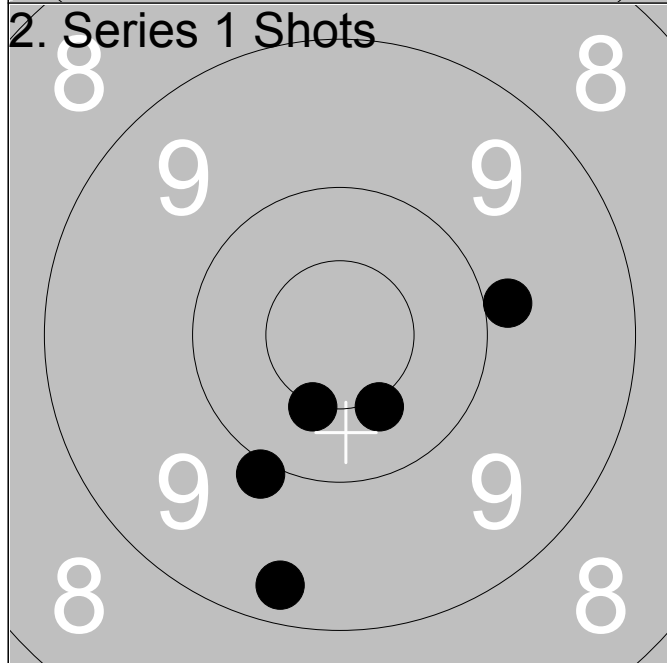

1:	9.9	→
2:	9.9	↙
3:	9.3	↙
4:	*10.4	↙
5:	*10.5	↙
Series		47.0
Total		317.0

Relay 4	Lane 19	Emelie Jansson
-------------------	-------------------	-----------------------

300m	Kvistbro	Ligg	Ör
------	----------	------	----

05.07.2014	Björkskottet 2014-07-05	Ramselefors SKF
------------	-------------------------	-----------------



1:	9.7	←
2:	7.5	↖
3:	9.8	→

Series	25.0
Total	225.0

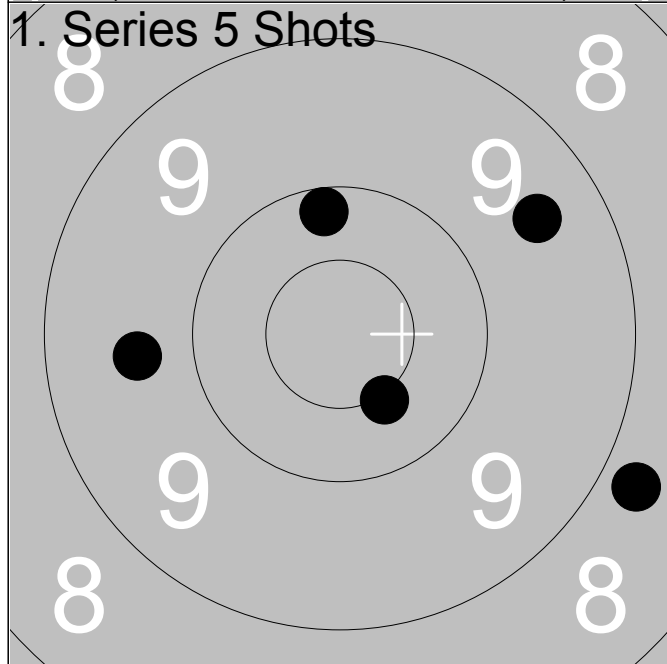

1:	8.8	↗
2:	9.5	↗
3:	9.6	←
4:	*10.5	↘
5:	10.2	↑

Series	46.0
Total	271.0

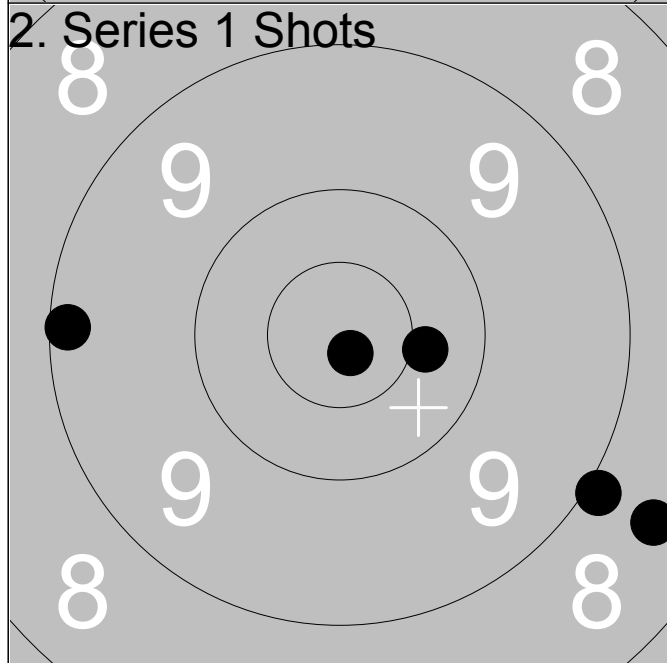

1:	10.4	→
2:	8.9	↘
3:	*10.8	↘
4:	8.5	↘
5:	9.2	←

Series	45.0
Total	316.0



1:	9.6	↙
2:	8.5	↘
3:	9.9	←

Series	26.0
Total	235.0

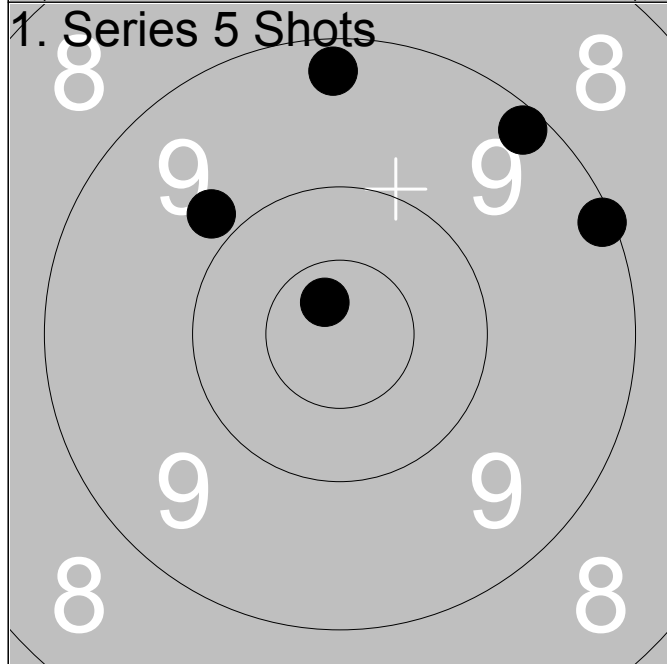

1:	*10.7	↖
2:	9.2	↑
3:	9.8	↖
4:	9.2	↗
5:	9.1	→

Series	46.0
Total	281.0

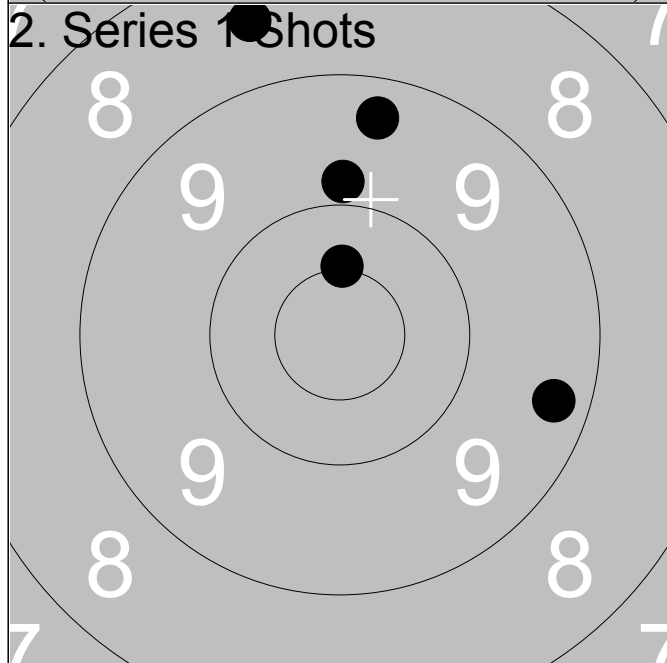

1:	9.3	→
2:	*10.5	↑
3:	8.5	↖
4:	9.9	↑
5:	9.3	↑

Series	45.0
Total	326.0

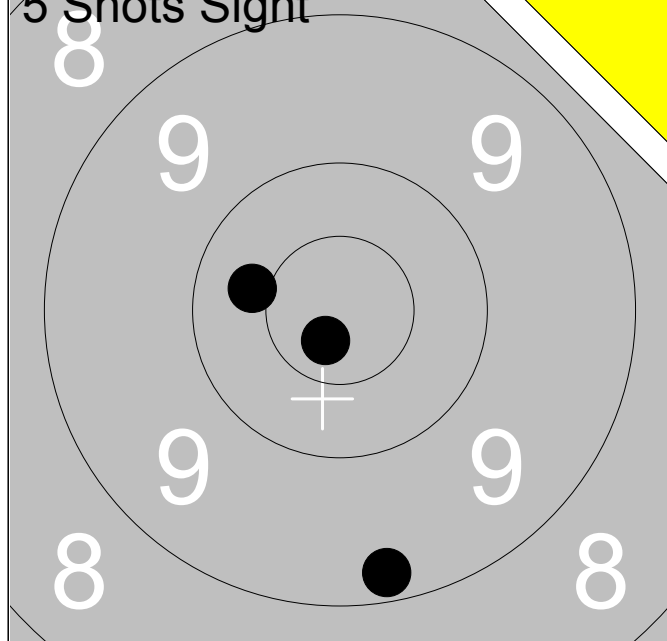

1:	10.4	←
2:	9.2	↓
3:	*10.7	↙
Series	29.0	
Total	232.0	

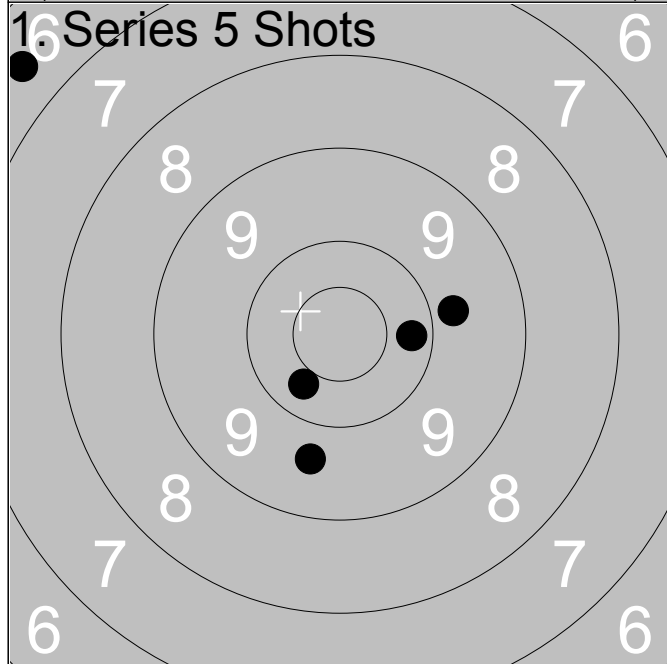

1:	9.8	→
2:	9.7	↓
3:	10.2	→
4:	10.3	↙
5:	6.6	↗
Series	44.0	
Total	276.0	

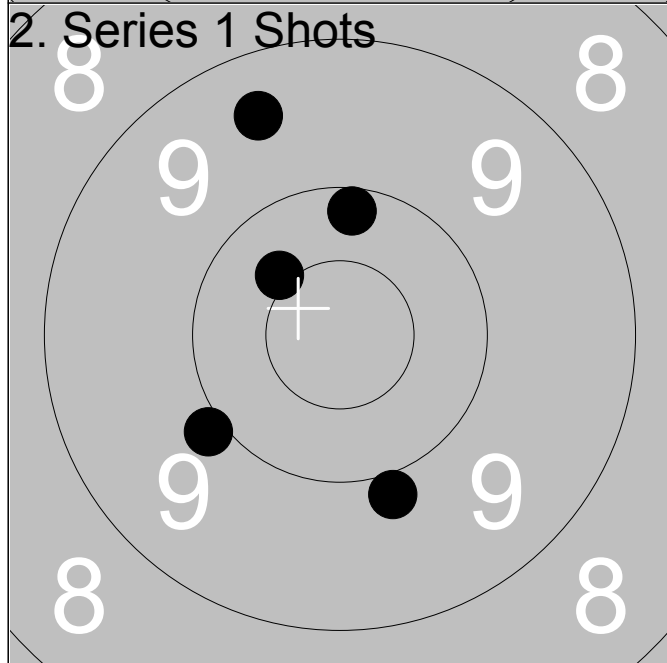

1:	10.2	↑
2:	*10.4	↖
3:	9.9	↙
4:	9.4	↑
5:	9.9	↓
Series	47.0	
Total	323.0	

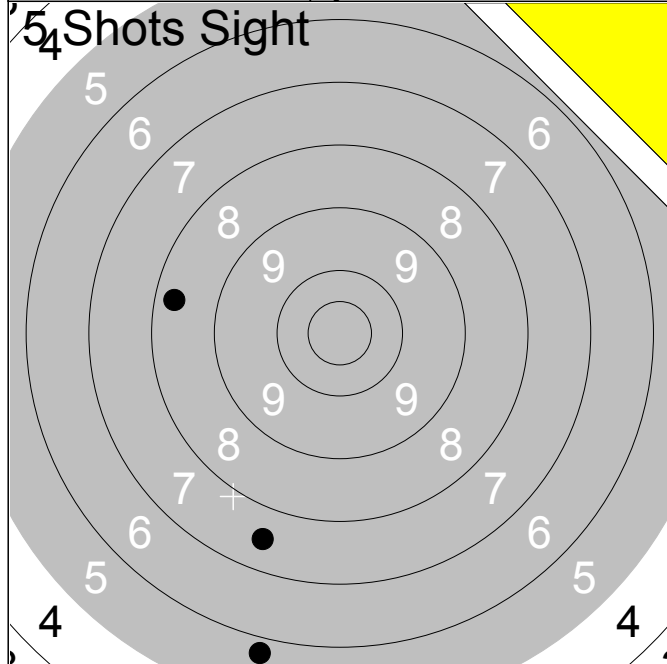

	1:	5.8			↓
	2:	7.5			↓
	3:	8.3			←
<hr/>					
Series					20.0
Total					224.0

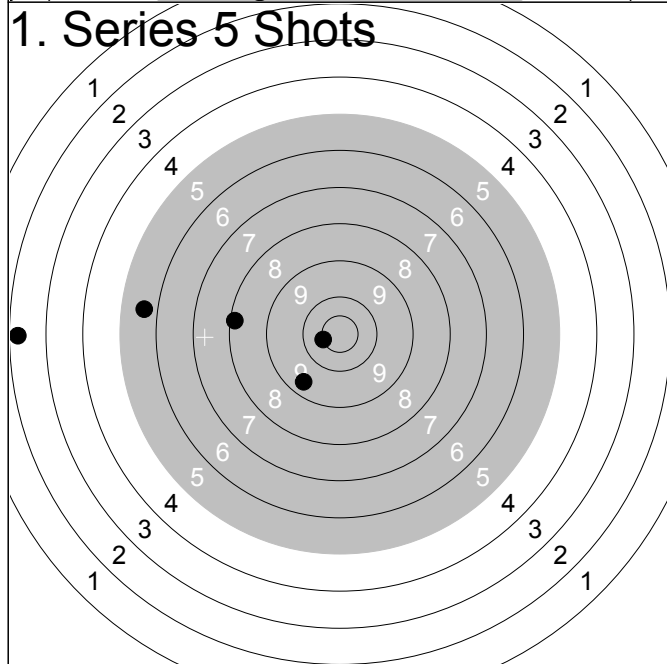

	1:	5.7			←
	2:	2.3			←
	3:	8.1			←
	4:	9.4			↓
	5:	*10.5			←
<hr/>					
Series					34.0
Total					258.0

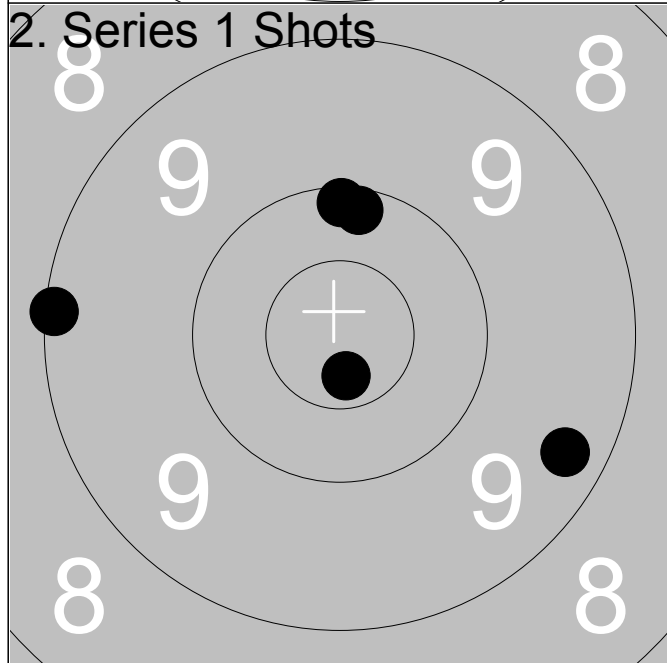

	1:	9.1			←
	2:	10.2			↑
	3:	10.1			↑
	4:	9.3			→
	5:	*10.7			↓
<hr/>					
Series					48.0
Total					306.0

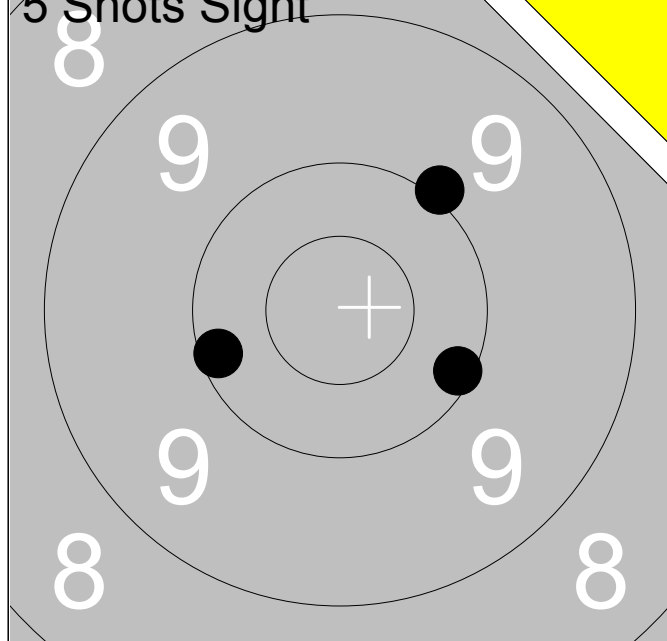

1:	10.1	→
2:	10.0	↗
3:	10.1	←
Series		30.0
Total		240.0

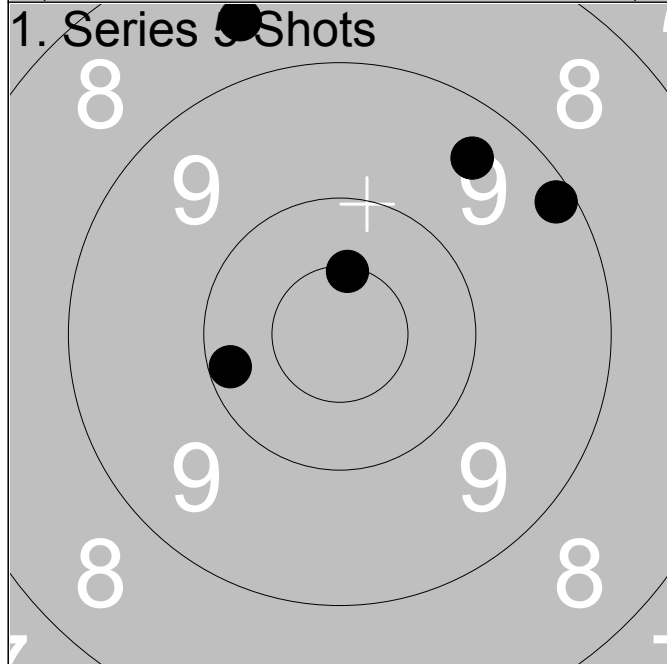

1:	8.6	↖
2:	*10.5	↑
3:	9.4	↗
4:	9.2	↘
5:	10.2	←
Series		46.0
Total		286.0

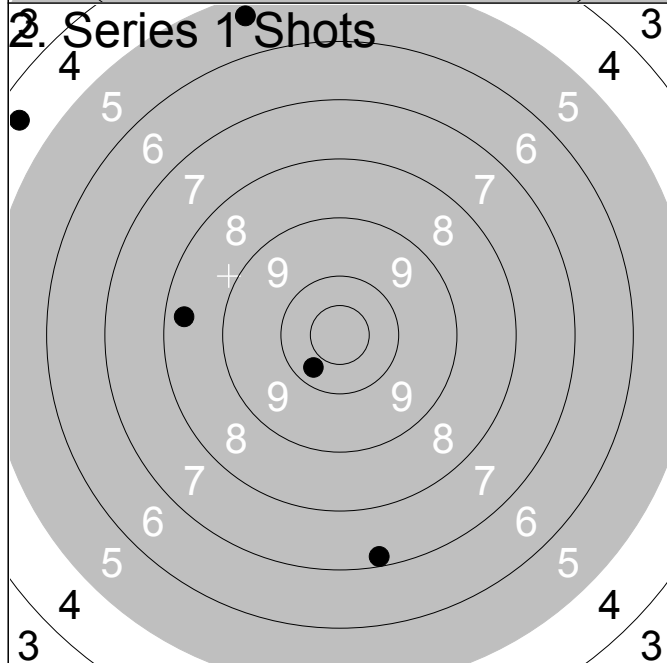

1:	7.2	↓
2:	10.3	↙
3:	8.4	←
4:	4.5	↗
5:	5.4	↑
Series		34.0
Total		320.0

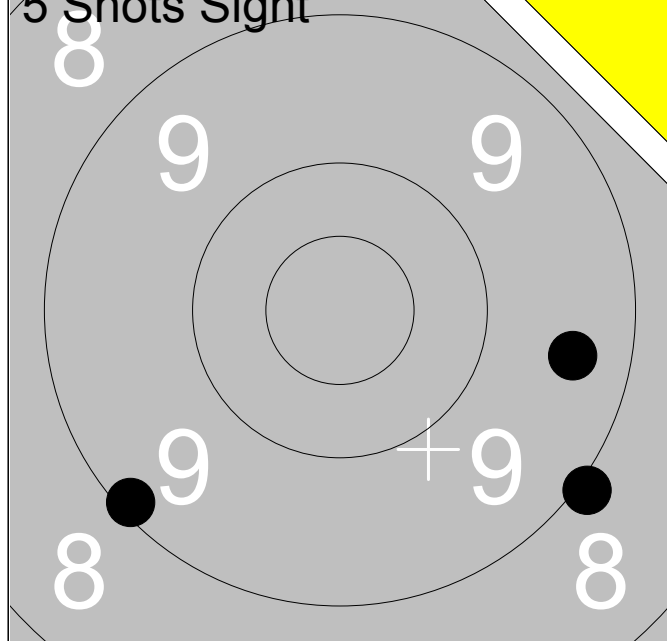

	1:	9.0	↘
	2:	9.1	↙
	3:	9.4	→
Series			27.0
Total			239.0

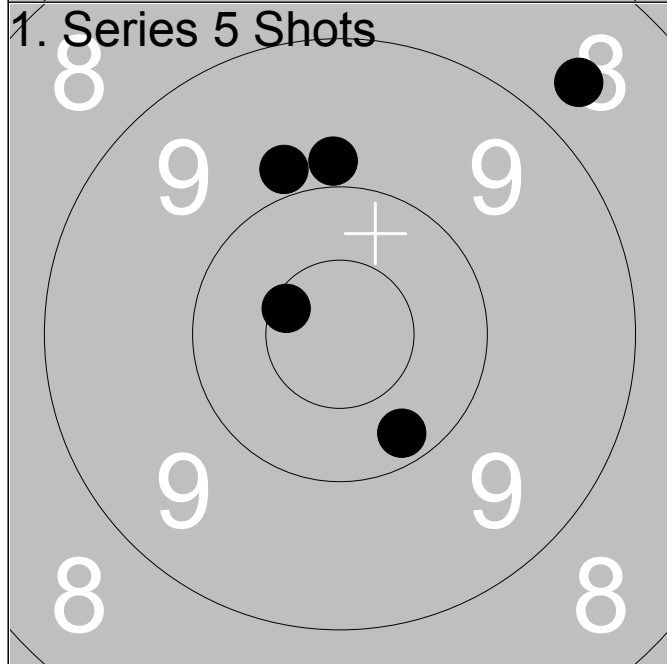

	1:	8.7	↗
	2:	*10.6	↖
	3:	9.9	↗
	4:	9.9	↑
	5:	10.2	↘
Series			46.0
Total			285.0

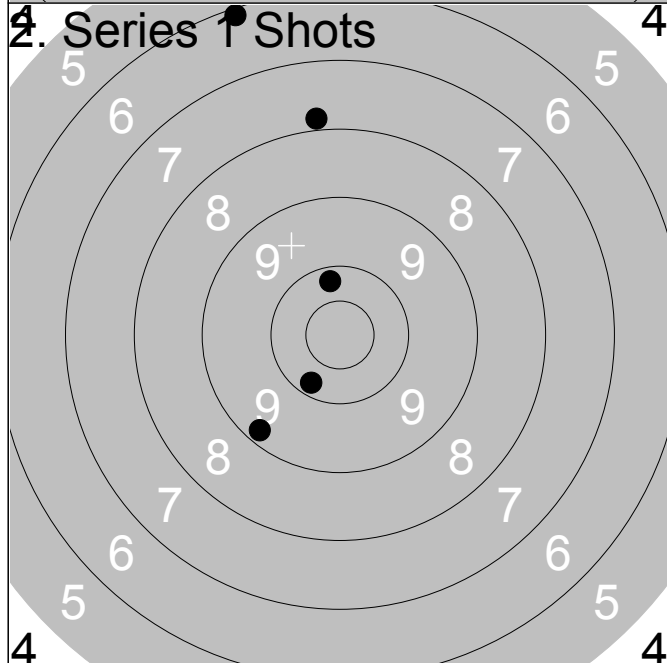

	1:	6.1	↑
	2:	7.9	↑
	3:	10.2	↑
	4:	10.2	↙
	5:	9.2	↙
Series			42.0
Total			327.0



1:	10.1	↓
2:	8.2	→
3:	*10.4	↑
Series	28.0	
Total	238.0	

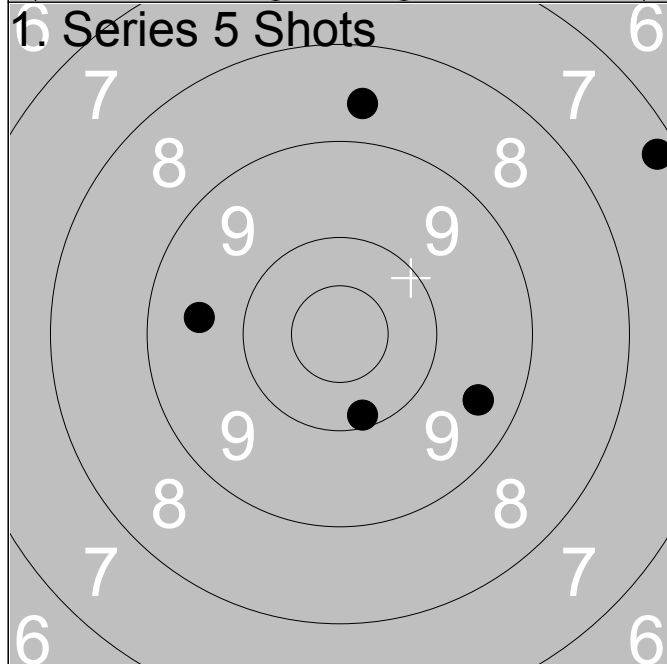

1:	8.6	↑
2:	10.1	↓
3:	9.4	→
4:	7.2	↗
5:	9.6	←
Series	43.0	
Total	281.0	

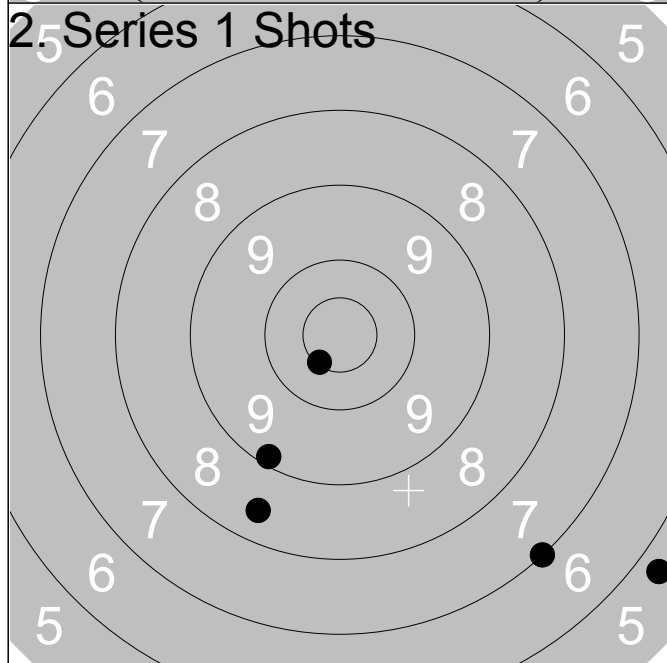

1:	5.7	↘
2:	*10.5	↙
3:	9.2	↘
4:	8.4	↘
5:	7.0	↘
Series	39.0	
Total	320.0	



	1:	9.7	↗
	2:	9.7	↗
	3:	9.6	↙
Series			27.0
Total			234.0

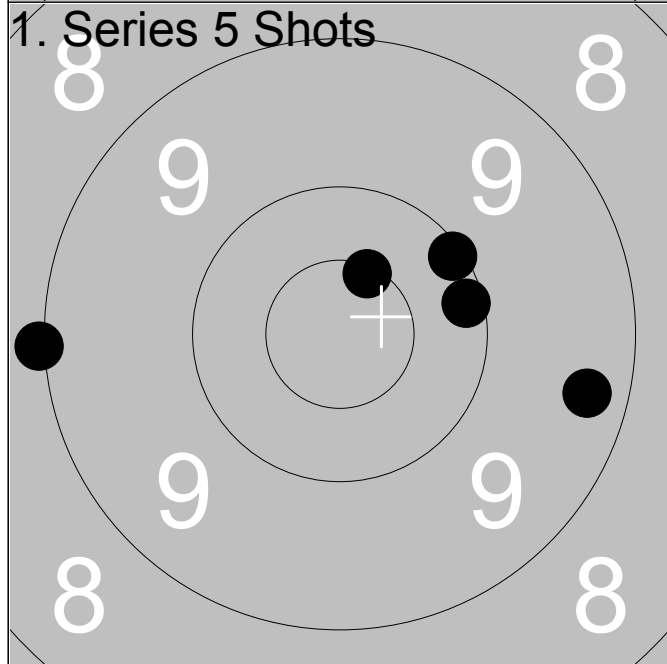

	1:	*10.5	↗
	2:	10.1	→
	3:	9.3	→
	4:	10.1	↗
	5:	9.0	←
Series			48.0
Total			282.0

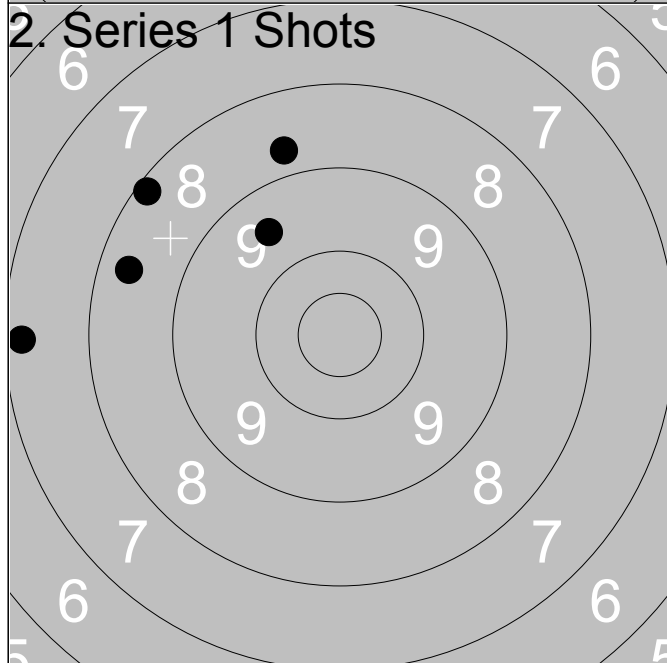

	1:	8.2	↗
	2:	8.7	↗
	3:	7.2	←
	4:	8.4	↖
	5:	9.5	↗
Series			40.0
Total			322.0



1:	9.9	→
2:	9.7	←
3:	7.9	←

Series	25.0
Total	232.0

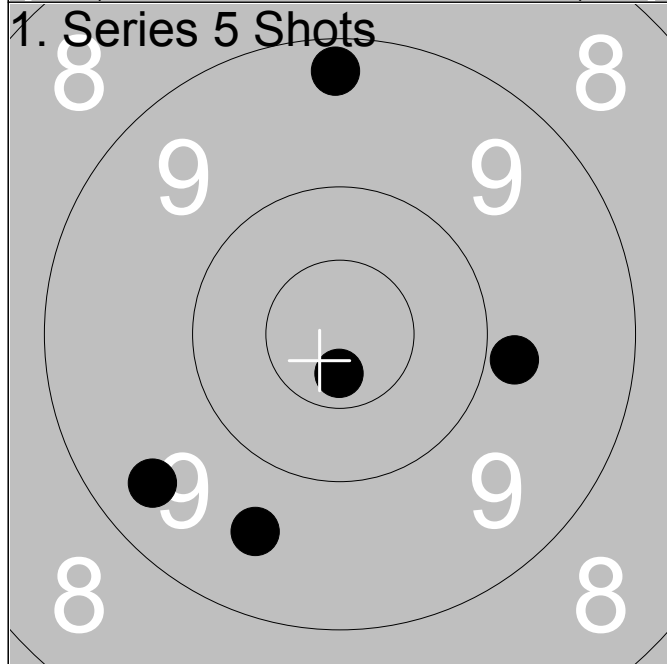

1:	9.6	↓
2:	*10.7	↓
3:	9.8	→
4:	9.2	↑
5:	9.4	↙

Series	46.0
Total	278.0

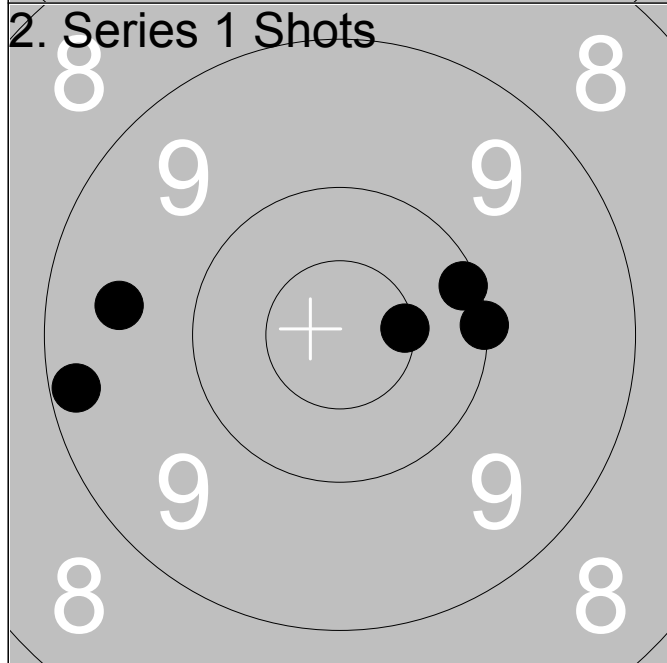

1:	9.2	←
2:	10.1	→
3:	9.5	←
4:	10.0	→
5:	*10.5	→

Series	48.0
Total	326.0



1:	9.3	↘
2:	9.0	↘
3:	9.7	↘
Series		27.0
Total		231.0

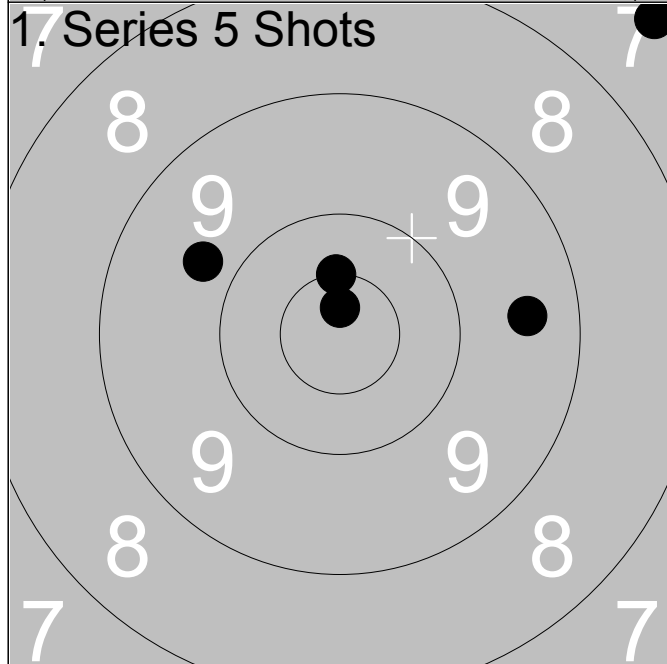

1:	7.3	↗
2:	9.7	↖
3:	*10.7	↑
4:	*10.5	↑
5:	9.5	→
Series		45.0
Total		276.0

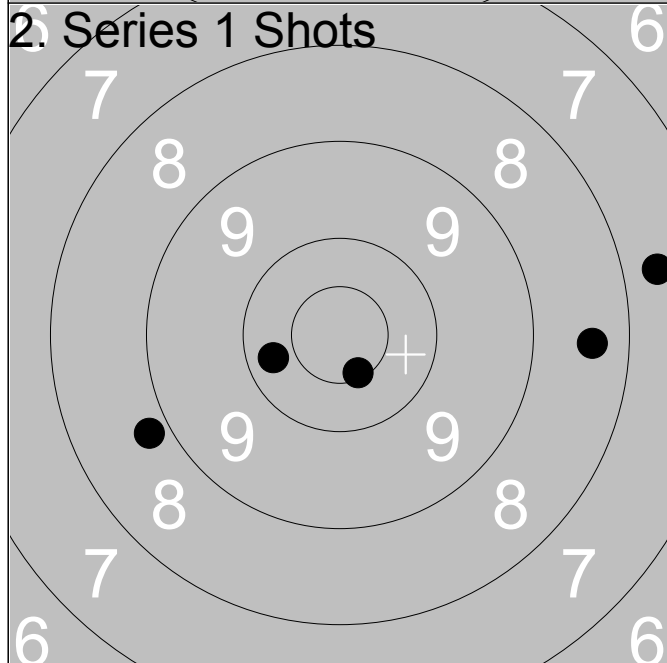

1:	8.4	→
2:	*10.5	↘
3:	7.7	→
4:	8.8	↖
5:	10.3	↖
Series		43.0
Total		319.0

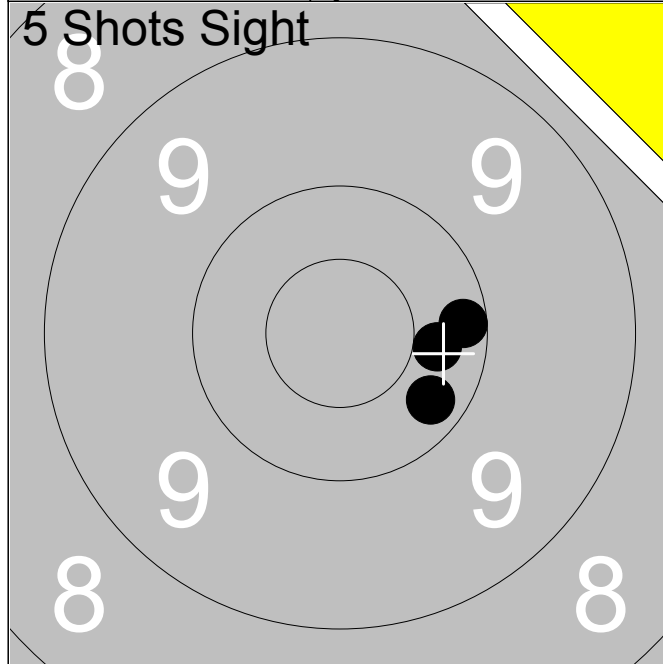

1:	10.3	→
2:	10.2	↘
3:	10.2	→
<hr/>		
Series	30.0	
Total	231.0	

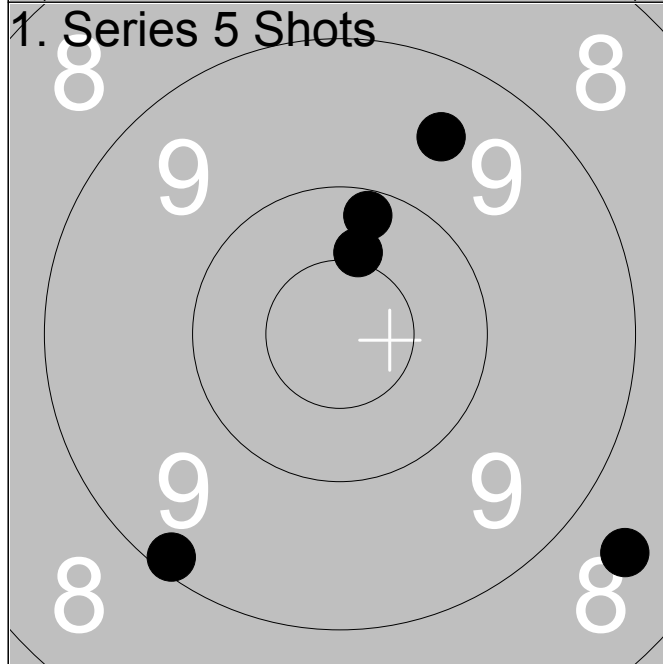

1:	9.1	↙
2:	8.6	↘
3:	9.5	↗
4:	10.2	↑
5:	*10.4	↑
<hr/>		
Series	46.0	
Total	277.0	

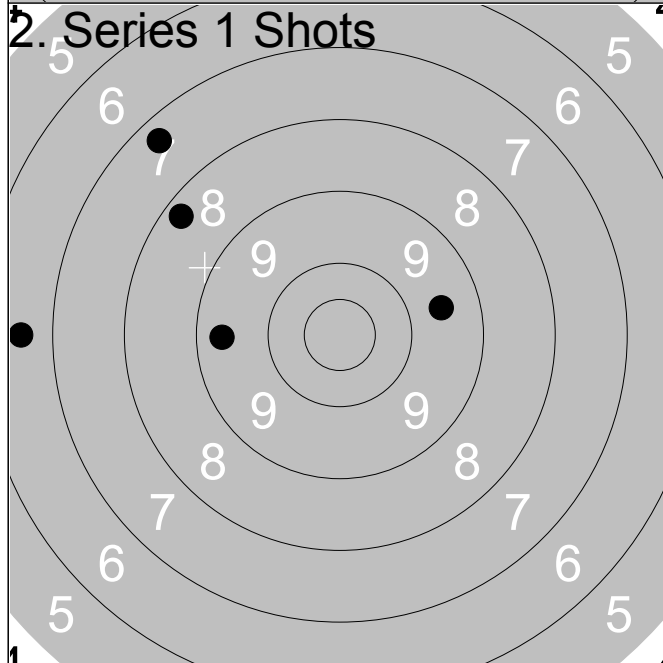

1:	7.3	↖
2:	9.4	←
3:	9.6	→
4:	6.6	←
5:	8.3	↗
<hr/>		
Series	39.0	
Total	316.0	



1:	9.4	↗
2:	10.2	↘
3:	9.3	↖

Series	28.0
Total	229.0

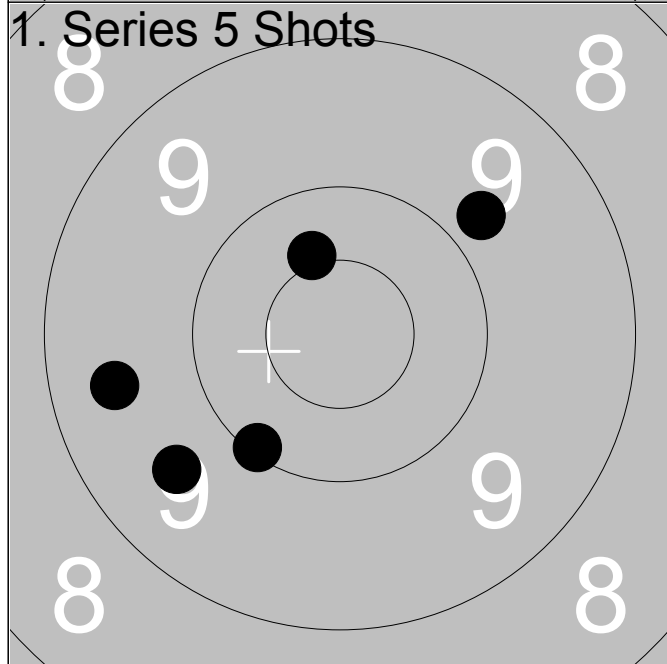

1:	*10.4	↖
2:	9.8	↗
3:	9.6	↘
4:	9.5	↖
5:	10.1	↘

Series	47.0
Total	276.0

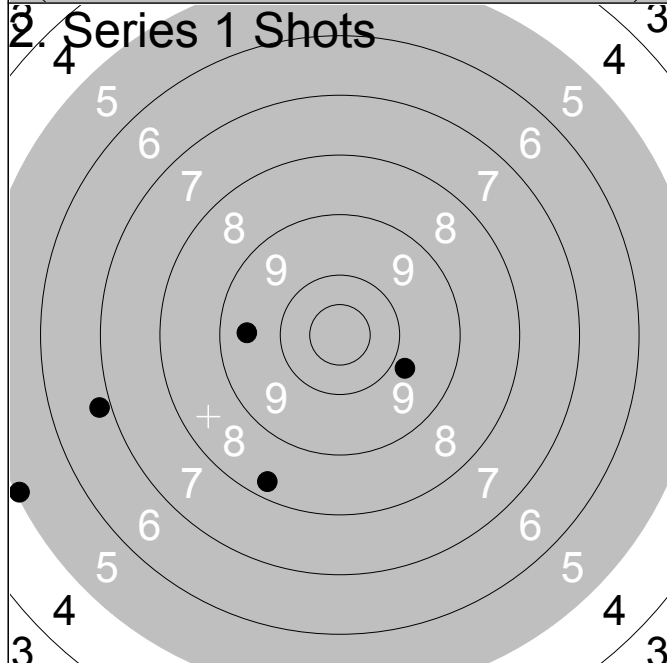

1:	9.8	↗
2:	5.1	↖
3:	9.5	↖
4:	8.3	↘
5:	6.8	↖

Series	37.0
Total	313.0

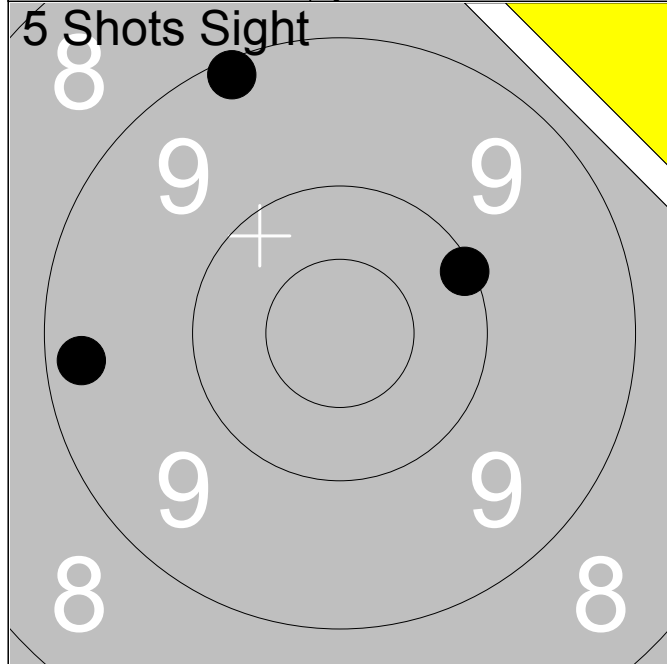

1:	9.1	↑
2:	10.1	↗
3:	9.3	←
Series		28.0
Total		226.0

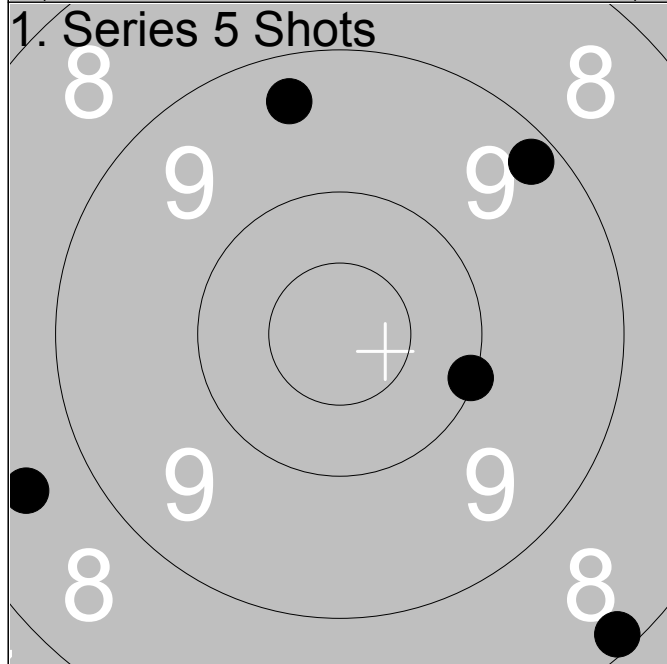

1:	9.4	↑
2:	9.2	↗
3:	8.6	↖
4:	10.0	→
5:	8.2	↘
Series		44.0
Total		270.0

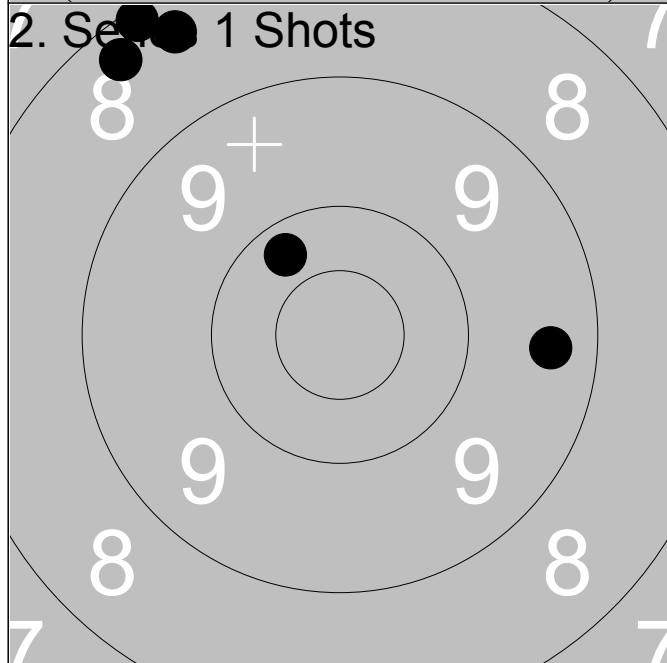

1:	8.3	↗
2:	9.4	→
3:	8.4	↗
4:	10.3	↗
5:	8.1	↗
Series		43.0
Total		313.0



1:	9.7	→
2:	9.0	←
3:	*10.6	←

Series	28.0
Total	225.0

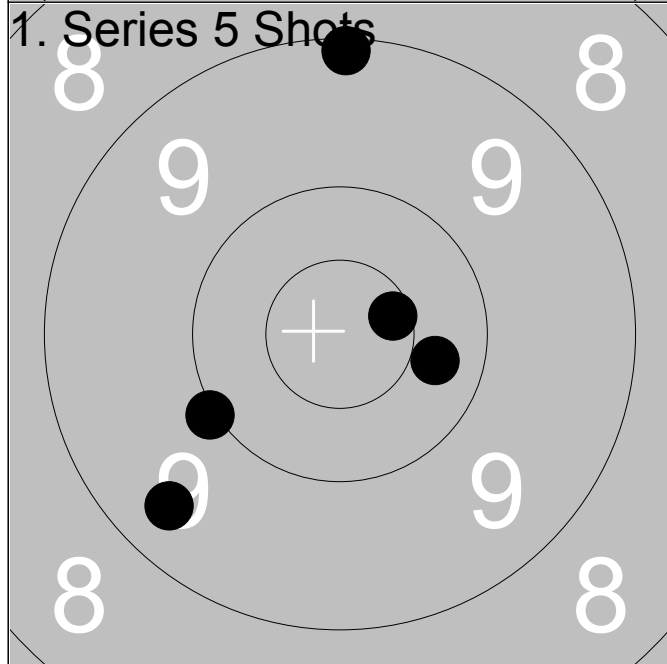

1:	9.1	↑
2:	*10.6	→
3:	10.3	→
4:	10.0	←
5:	9.4	↙

Series	48.0
Total	273.0

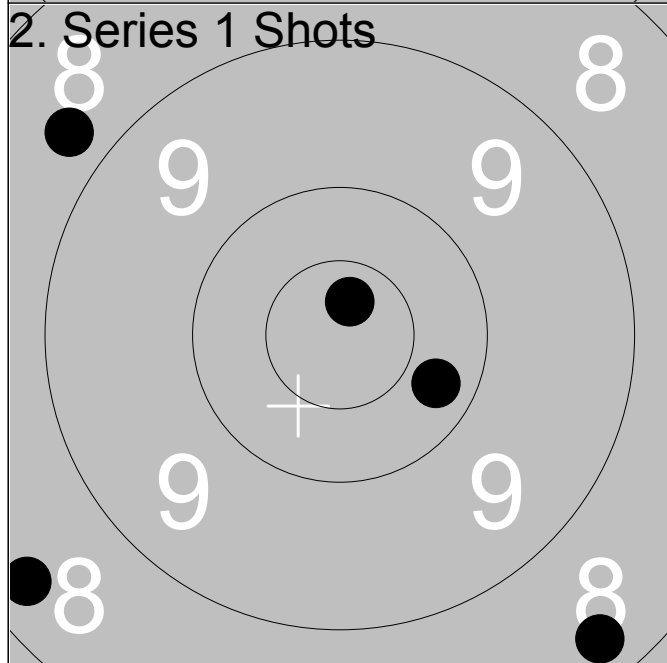

1:	8.7	↖
2:	10.3	→
3:	*10.7	↑
4:	8.3	↘
5:	8.3	↙

Series	44.0
Total	317.0

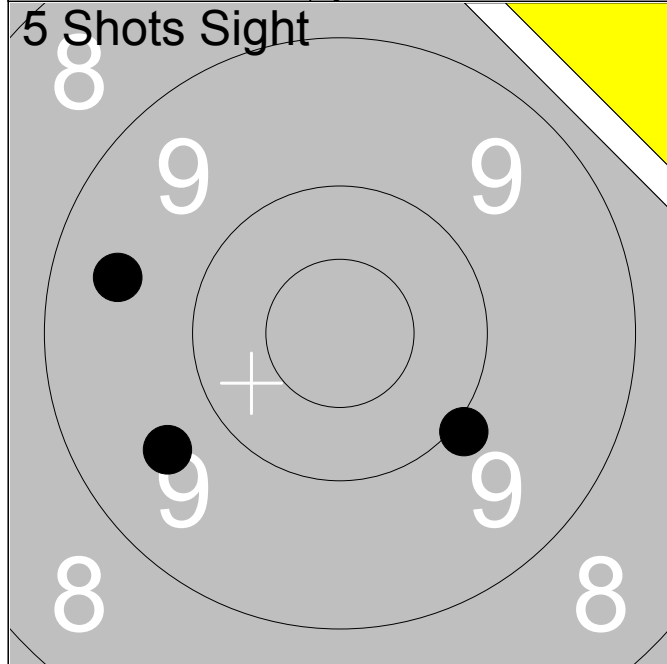

1:	10.0	↘
2:	9.5	↖
3:	9.6	↙
Series	28.0	
Total	223.0	

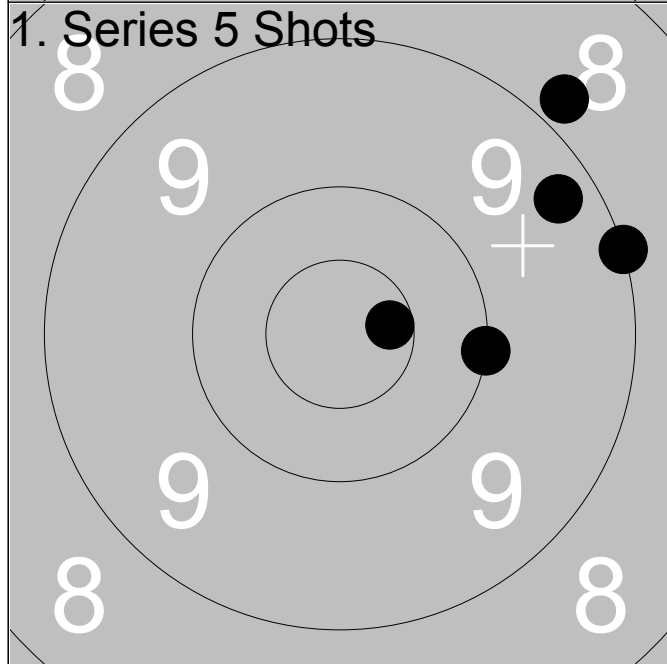

1:	8.8	↗
2:	10.0	→
3:	9.3	↗
4:	*10.6	→
5:	9.0	→
Series	46.0	
Total	269.0	

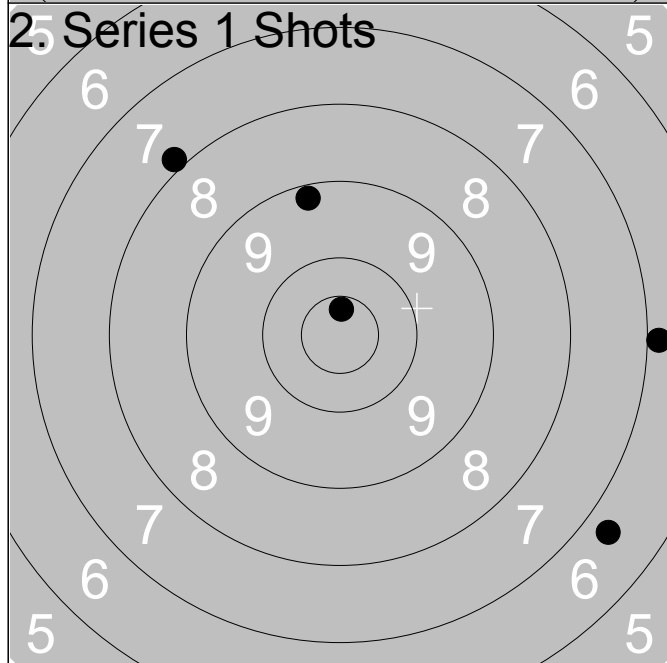

1:	6.7	↘
2:	*10.6	↑
3:	6.9	→
4:	7.9	↖
5:	9.2	↑
Series	38.0	
Total	307.0	

Relay	Lane	Ulf Ohlsson	
5	12		

300m	Umeå	Sen-A	Vb
------	------	-------	----

05.07.2014	Björskottet 2014-07-05	Ramselefors SKF
------------	------------------------	-----------------

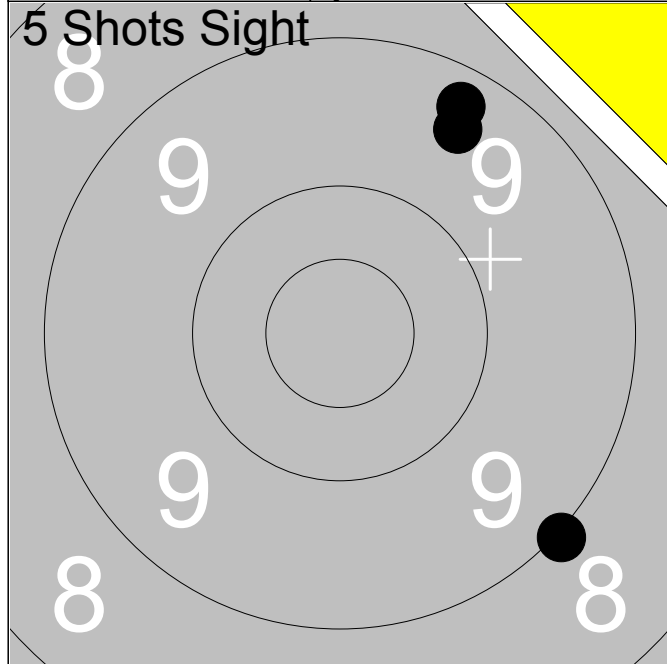

1:	9.4	↗
2:	9.0	↘
3:	9.3	↗
Series	27.0	
Total	223.0	

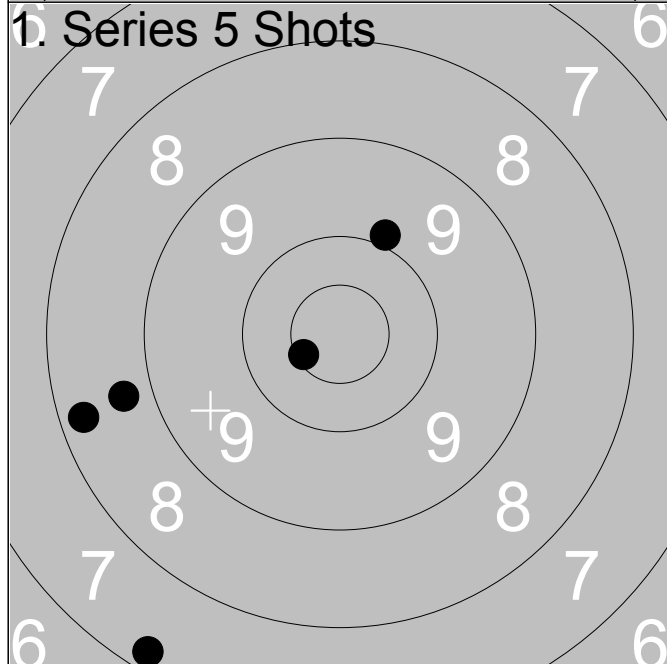

1:	9.9	↗
2:	*10.6	↖
3:	7.2	↘
4:	8.3	↖
5:	8.7	↖
Series	42.0	
Total	265.0	

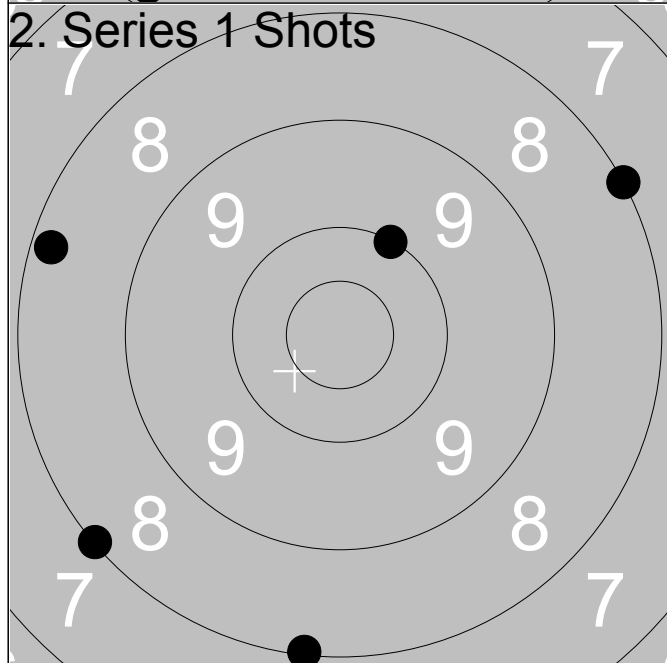

1:	8.2	↖
2:	8.1	↓
3:	8.0	↖
4:	10.0	↗
5:	8.0	↗
Series	42.0	
Total	307.0	



	1:	8.2			→
	2:	9.2			↑
	3:	9.5			↖
<hr/>					
Series					26.0
Total					219.0

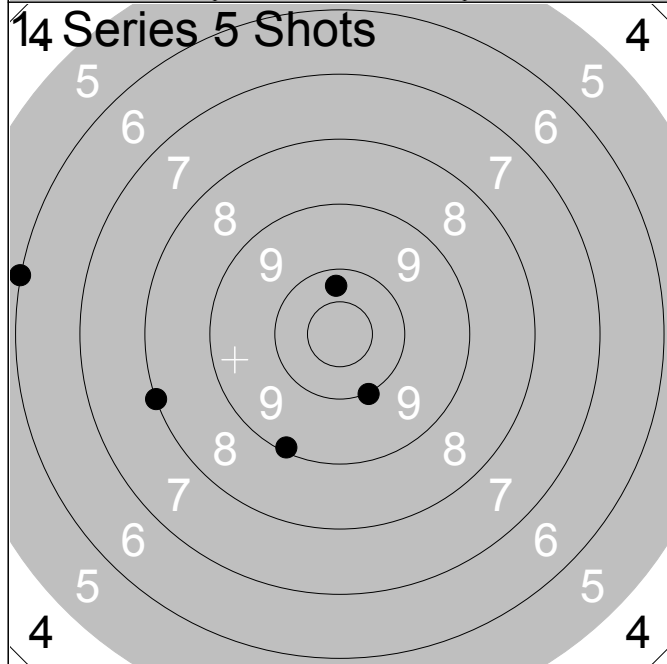

	1:	10.3			↑
	2:	10.0			↘
	3:	8.0			↖
	4:	6.0			↖
	5:	9.1			↘
<hr/>					
Series					43.0
Total					262.0

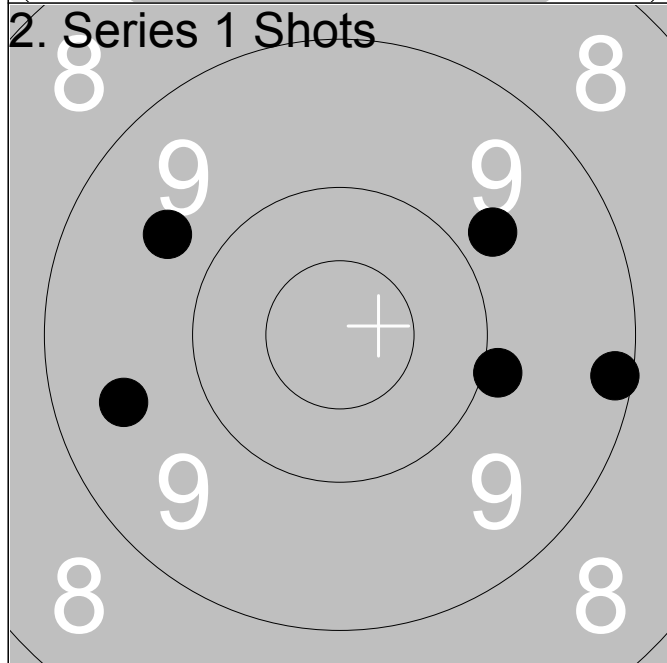

	1:	9.8			↗
	2:	9.9			→
	3:	9.1			→
	4:	9.7			↗
	5:	9.5			↖
<hr/>					
Series					45.0
Total					307.0

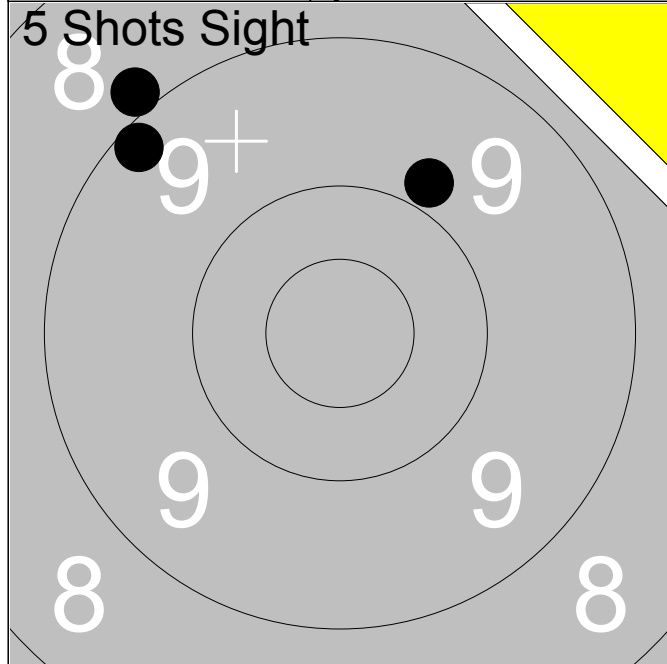

1:	9.2	↗
2:	9.8	↗
3:	8.9	↗

Series	26.0
Total	233.0

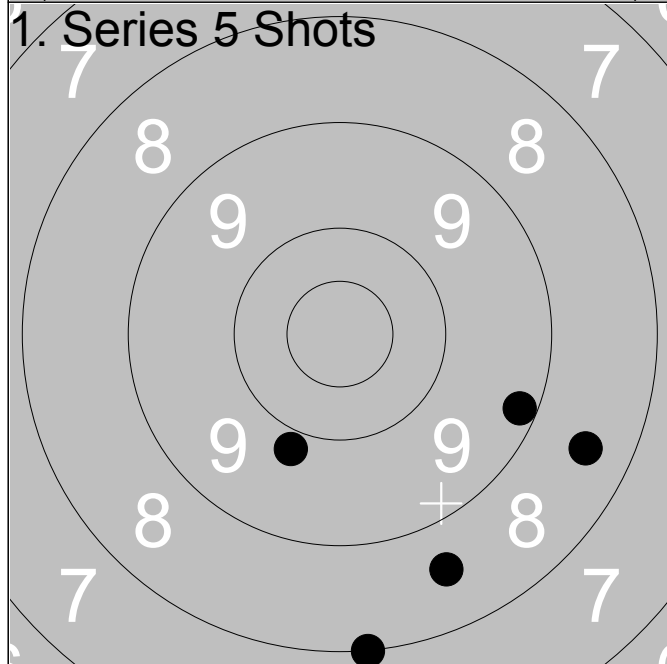

1:	8.6	↘
2:	9.9	↘
3:	8.5	↘
4:	9.2	↘
5:	8.0	↘

Series	42.0
Total	275.0

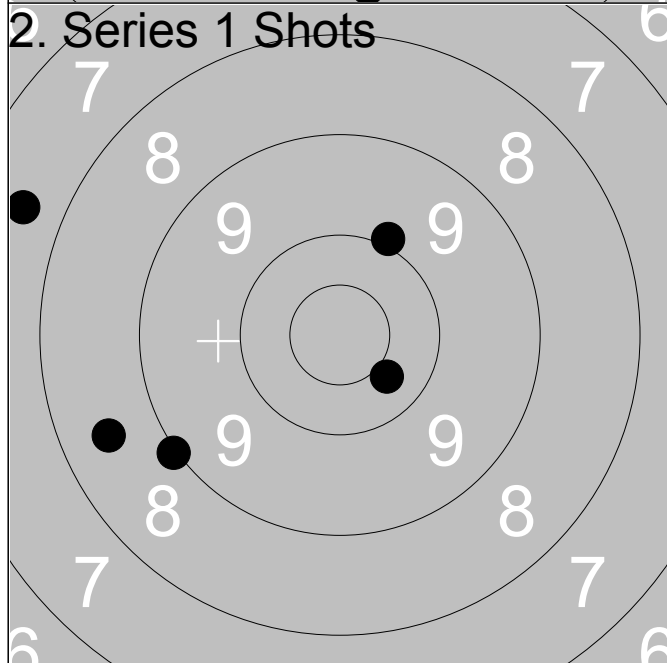

1:	8.5	↖
2:	9.0	↖
3:	10.4	↘
4:	10.0	↗
5:	7.6	↖

Series	44.0
Total	319.0

<p>5 Shots Sight</p>	<table style="width:100%;"> <tr><td>1:</td><td style="text-align:right;">9.3</td><td style="text-align:right;">↗</td></tr> <tr><td>2:</td><td style="text-align:right;">9.9</td><td style="text-align:right;">↘</td></tr> <tr><td>3:</td><td style="text-align:right;">9.4</td><td style="text-align:right;">↖</td></tr> </table>	1:	9.3	↗	2:	9.9	↘	3:	9.4	↖
1:	9.3	↗								
2:	9.9	↘								
3:	9.4	↖								
<table style="width:100%;"> <tr> <td style="width:80%;">Series</td> <td style="text-align:right;">27.0</td> </tr> <tr> <td colspan="2" style="border-top: 1px solid black;">Total</td> <td style="text-align:right; border-top: 1px solid black;">228.0</td> </tr> </table>		Series	27.0	Total		228.0				
Series	27.0									
Total		228.0								

<p>1. Series 5 Shots</p>	<table style="width:100%;"> <tr><td>1:</td><td style="text-align:right;">9.7</td><td style="text-align:right;">↓</td></tr> <tr><td>2:</td><td style="text-align:right;">9.9</td><td style="text-align:right;">↘</td></tr> <tr><td>3:</td><td style="text-align:right;">10.1</td><td style="text-align:right;">→</td></tr> <tr><td>4:</td><td style="text-align:right;">9.0</td><td style="text-align:right;">↖</td></tr> <tr><td>5:</td><td style="text-align:right;">9.4</td><td style="text-align:right;">↘</td></tr> </table>	1:	9.7	↓	2:	9.9	↘	3:	10.1	→	4:	9.0	↖	5:	9.4	↘
1:	9.7	↓														
2:	9.9	↘														
3:	10.1	→														
4:	9.0	↖														
5:	9.4	↘														
<table style="width:100%;"> <tr> <td style="width:80%;">Series</td> <td style="text-align:right;">46.0</td> </tr> <tr> <td colspan="2" style="border-top: 1px solid black;">Total</td> <td style="text-align:right; border-top: 1px solid black;">274.0</td> </tr> </table>		Series	46.0	Total		274.0										
Series	46.0															
Total		274.0														

<p>2. Series 1 Shots</p>	<table style="width:100%;"> <tr><td>1:</td><td style="text-align:right;">8.1</td><td style="text-align:right;">↓</td></tr> <tr><td>2:</td><td style="text-align:right;">8.3</td><td style="text-align:right;">↘</td></tr> <tr><td>3:</td><td style="text-align:right;">9.1</td><td style="text-align:right;">↓</td></tr> <tr><td>4:</td><td style="text-align:right;">9.0</td><td style="text-align:right;">↘</td></tr> <tr><td>5:</td><td style="text-align:right;">8.7</td><td style="text-align:right;">↘</td></tr> </table>	1:	8.1	↓	2:	8.3	↘	3:	9.1	↓	4:	9.0	↘	5:	8.7	↘
1:	8.1	↓														
2:	8.3	↘														
3:	9.1	↓														
4:	9.0	↘														
5:	8.7	↘														
<table style="width:100%;"> <tr> <td style="width:80%;">Series</td> <td style="text-align:right;">42.0</td> </tr> <tr> <td colspan="2" style="border-top: 1px solid black;">Total</td> <td style="text-align:right; border-top: 1px solid black;">316.0</td> </tr> </table>		Series	42.0	Total		316.0										
Series	42.0															
Total		316.0														

Relay 5	Lane 16	Daniel Wallberg
-------------------	-------------------	------------------------

300m	Loos	Sen-B	Gä
------	------	-------	----

05.07.2014	Björkskottet 2014-07-05	Ramselefors SKF
------------	-------------------------	-----------------



1:	8.2	↓
2:	8.5	→
3:	9.6	↗

Series	25.0
Total	227.0

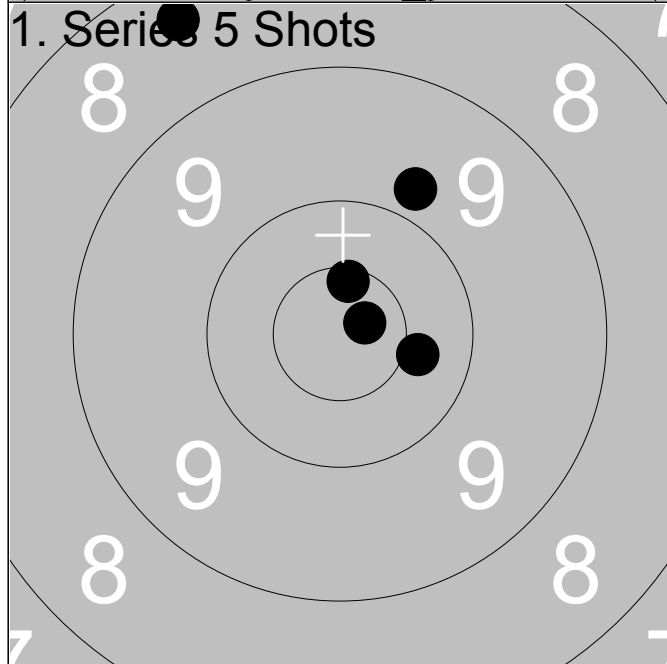

1:	8.4	↖
2:	10.4	→
3:	*10.8	↗
4:	9.8	↗
5:	*10.6	↑

Series	47.0
Total	274.0

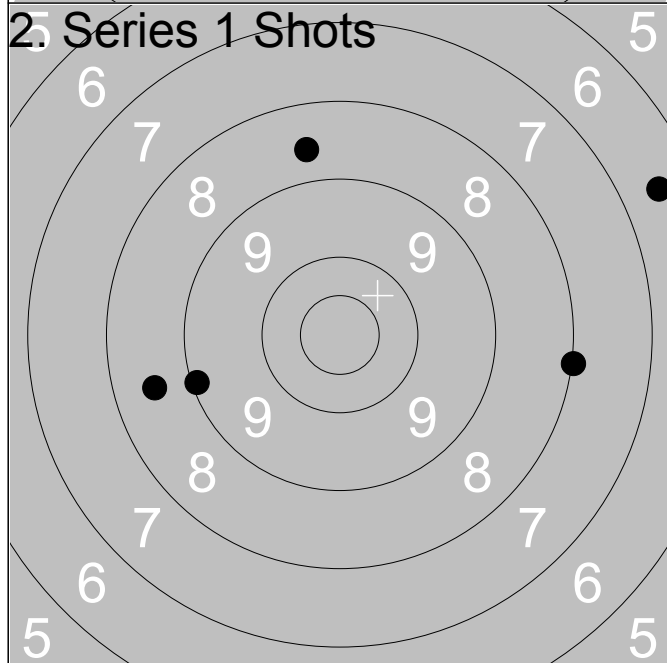

1:	8.6	↑
2:	8.6	←
3:	6.5	↗
4:	9.1	←
5:	8.0	→

Series	39.0
Total	313.0

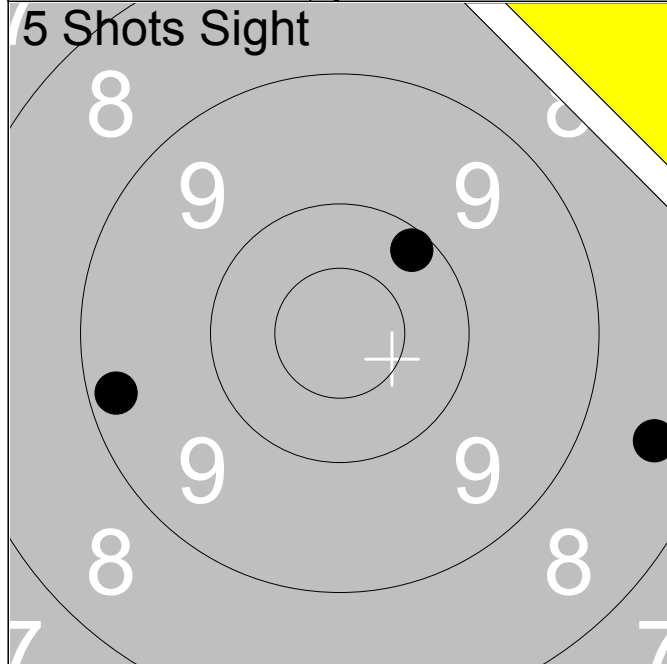

	1:	9.2	←
	2:	8.5	→
	3:	10.2	↗
<hr/>			
Series			27.0
Total			224.0

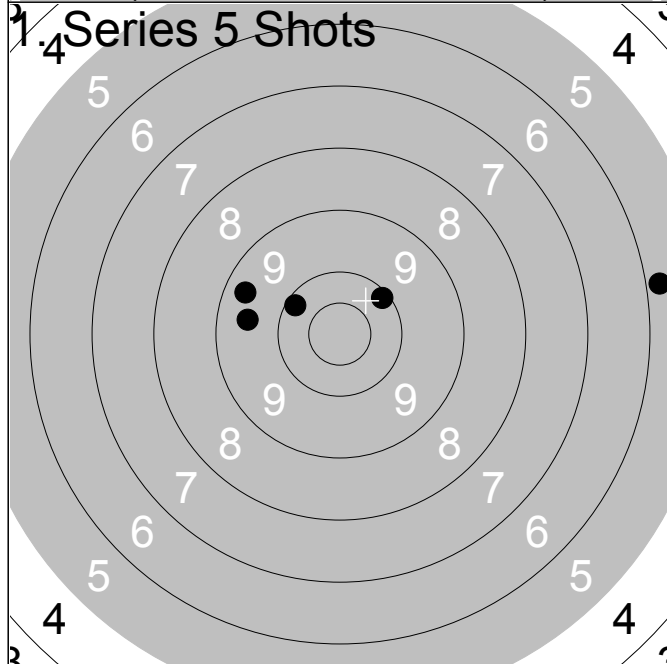

	1:	10.2	↖
	2:	9.4	↖
	3:	10.1	↗
	4:	9.5	←
	5:	5.8	→
<hr/>			
Series			43.0
Total			267.0

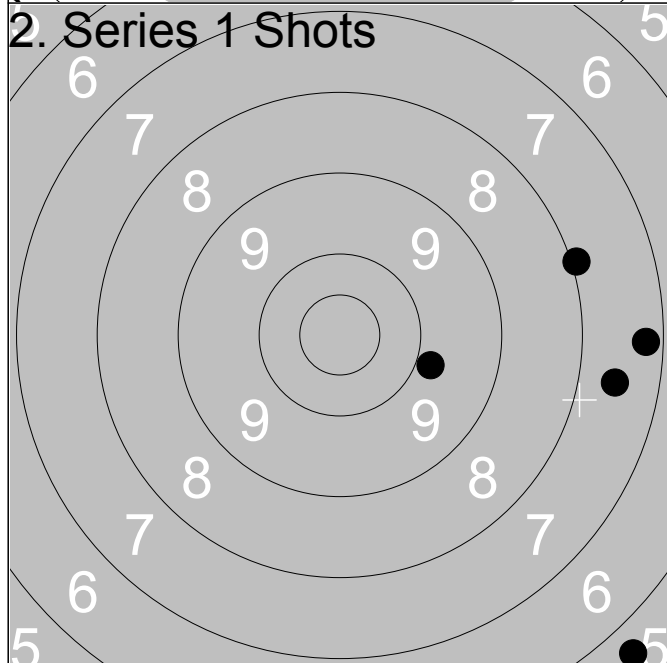

	1:	7.6	→
	2:	5.7	↘
	3:	8.0	→
	4:	9.8	→
	5:	7.2	→
<hr/>			
Series			36.0
Total			303.0

Relay	Lane	Linda Bergman	
5	18		

300m	Ununge	Sen-B	St
------	--------	-------	----

05.07.2014	Björskottet 2014-07-05	Ramselefors SKF
------------	------------------------	-----------------



1:	6.4	→
2:	8.2	→
3:	9.6	↙

Series	23.0
Total	223.0

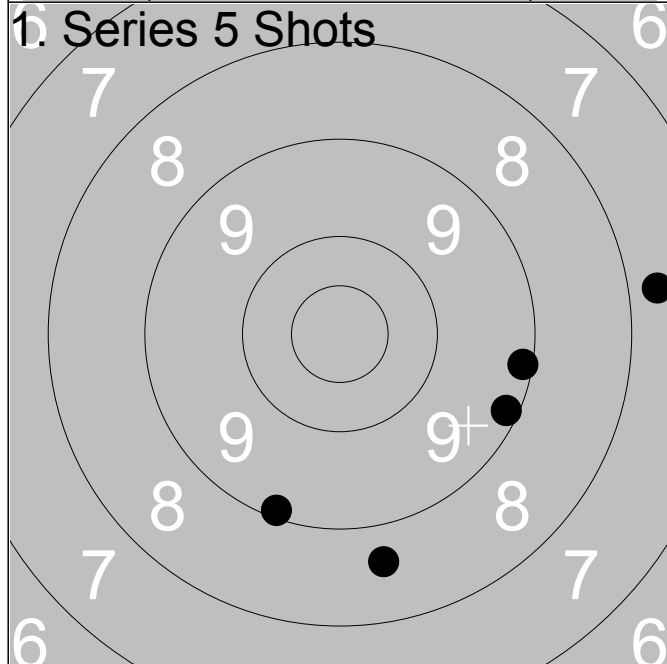

1:	7.7	→
2:	9.1	↘
3:	9.1	→
4:	9.1	↙
5:	8.6	↘

Series	42.0
Total	265.0

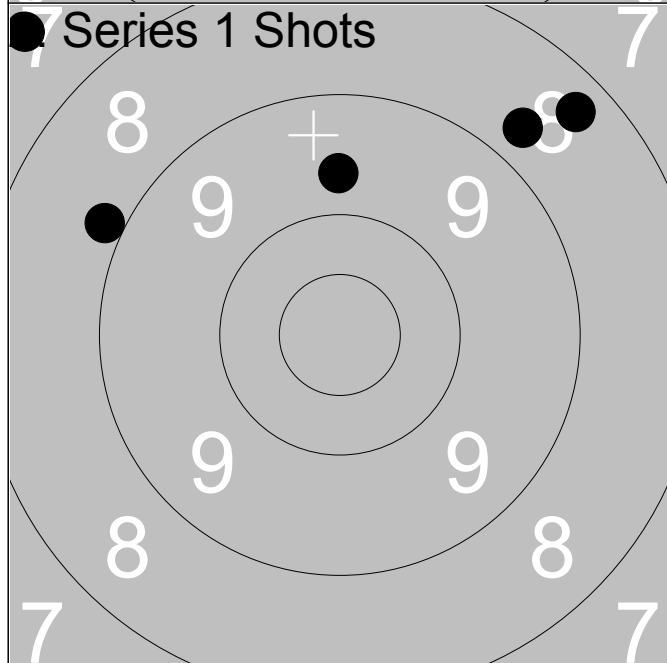

1:	8.9	↖
2:	8.7	↗
3:	9.7	↑
4:	8.3	↗
5:	7.4	↖

Series	40.0
Total	305.0

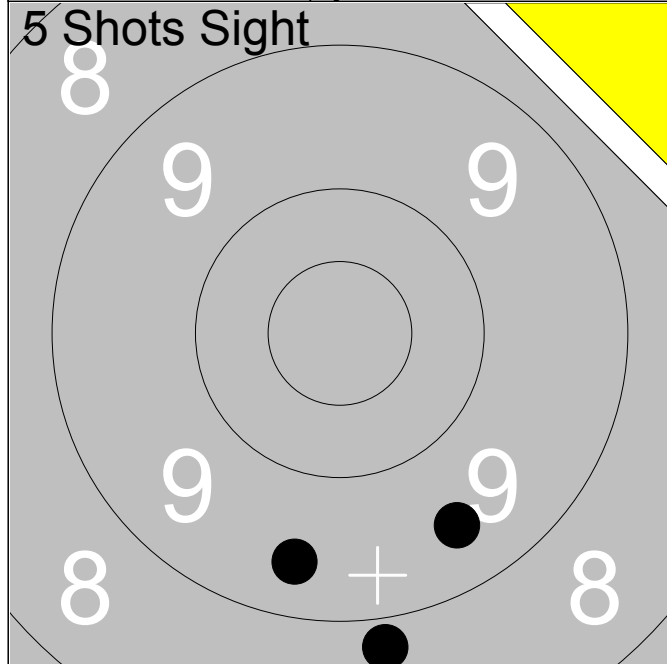

1:	9.5	↘
2:	9.4	↘
3:	8.8	↘
Series	26.0	
Total	222.0	

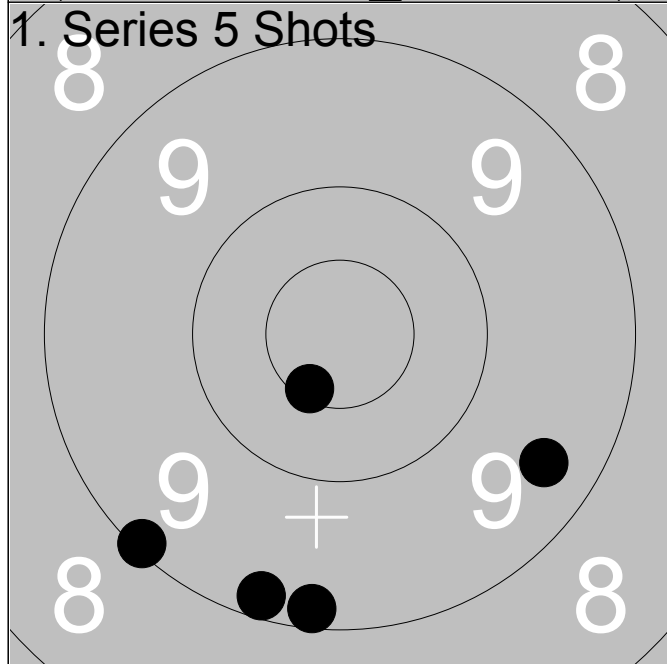

1:	9.1	↙
2:	9.2	↘
3:	*10.6	↙
4:	9.4	↘
5:	9.2	↘
Series	46.0	
Total	268.0	

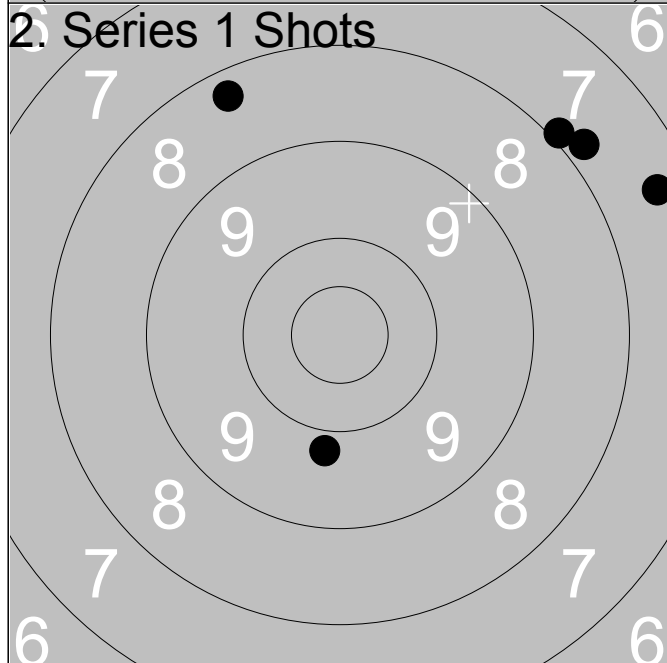

1:	7.4	↗
2:	7.8	↗
3:	9.8	↘
4:	7.9	↗
5:	8.3	↖
Series	38.0	
Total	306.0	



1:	9.4	↑
2:	9.1	→
3:	8.9	↗
Series		26.0
Total		222.0

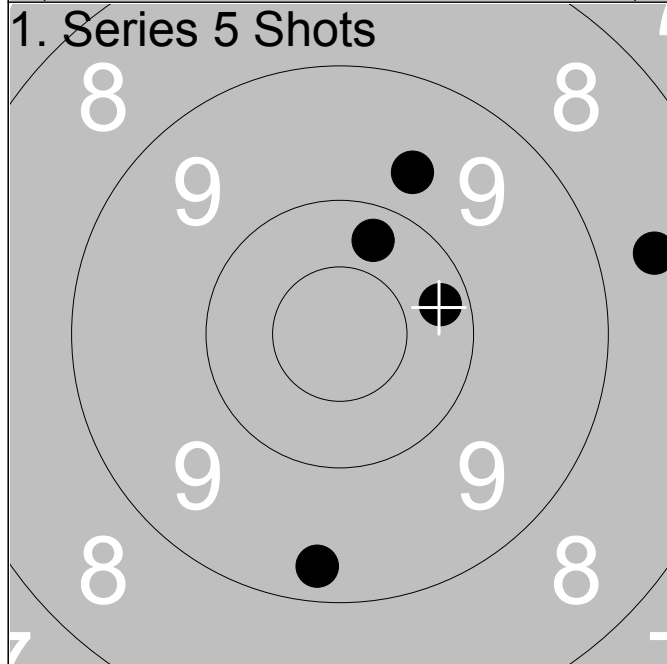

1:	10.3	↑
2:	8.6	→
3:	10.2	→
4:	9.7	↑
5:	9.3	↓
Series		46.0
Total		268.0

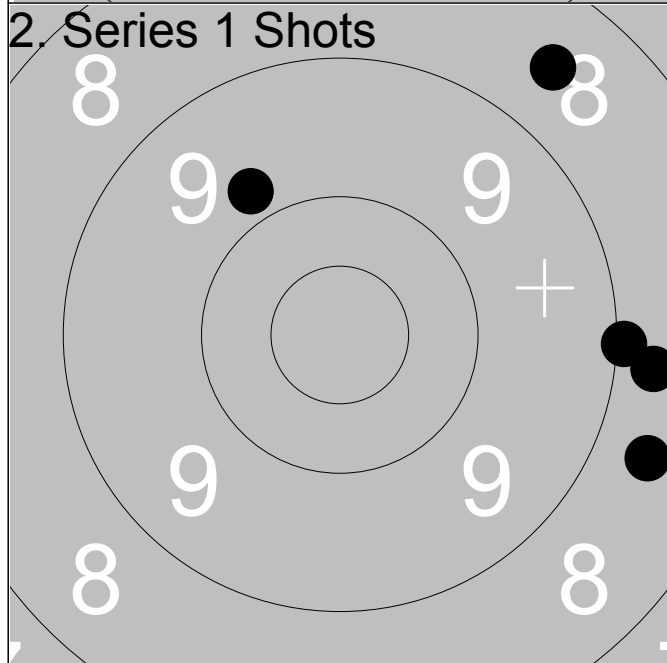

1:	9.0	→
2:	8.6	→
3:	8.7	→
4:	8.6	↗
5:	9.8	↖
Series		42.0
Total		310.0

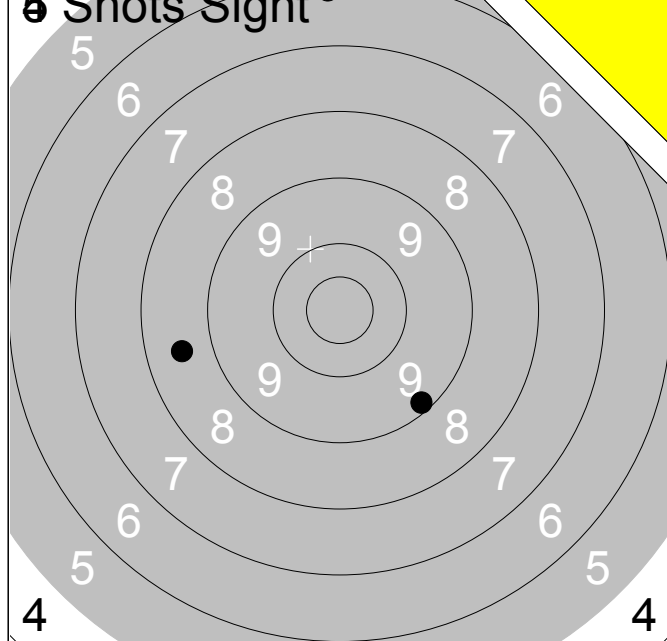

	1:	6.2			↑
	2:	8.6			←
	3:	9.2			↓
Series					23.0
Total					216.0

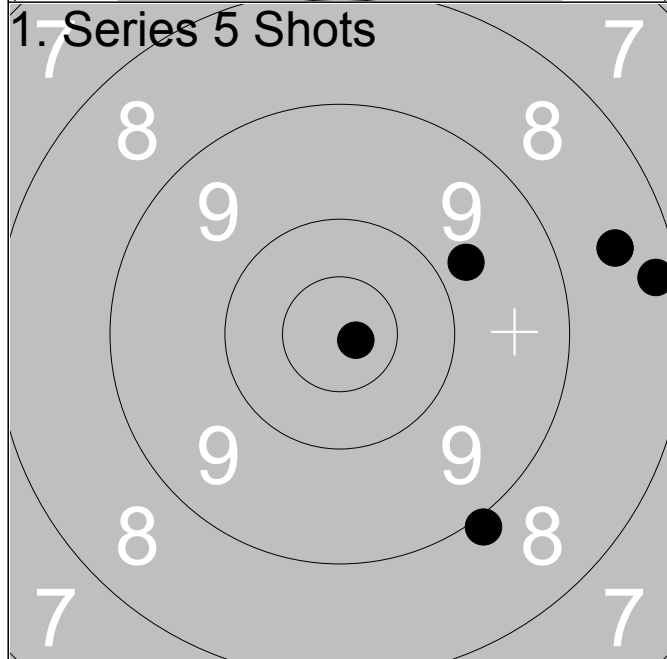

	1:	9.8			↗
	2:	8.9			↘
	3:	*10.8			→
	4:	8.5			→
	5:	8.2			→
Series					43.0
Total					259.0

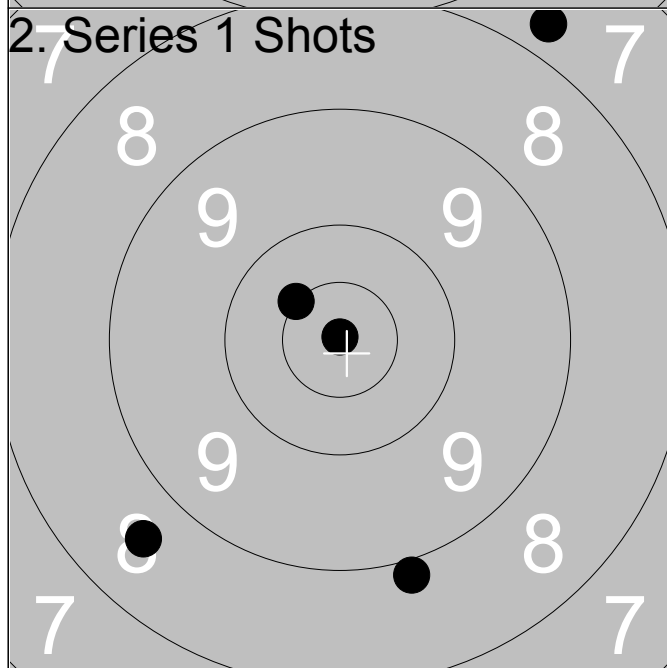

	1:	*10.5			↖
	2:	*10.9			↑
	3:	8.9			↓
	4:	8.6			↙
	5:	7.7			↗
Series					43.0
Total					302.0



1:	8.8	➔
2:	10.0	↑
3:	9.1	➔
Series		27.0
Total		215.0

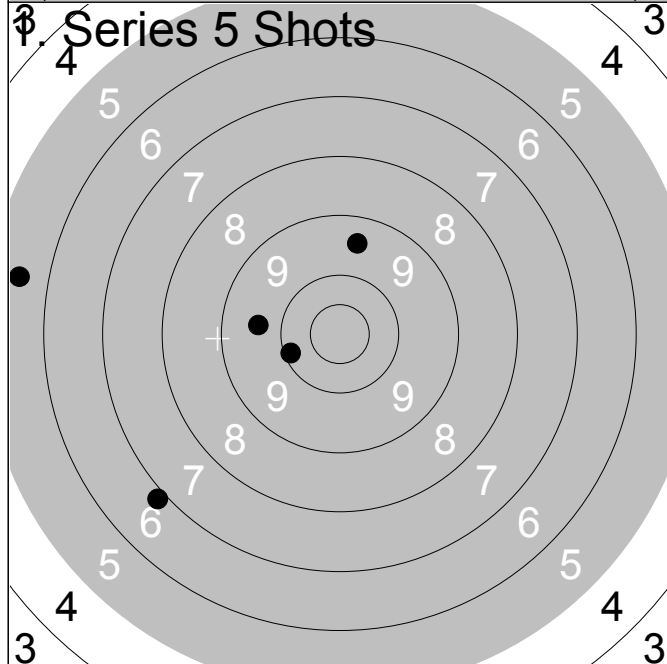

1:	9.5	↑
2:	6.9	↙
3:	10.1	←
4:	9.6	←
5:	5.5	←
Series		39.0
Total		254.0

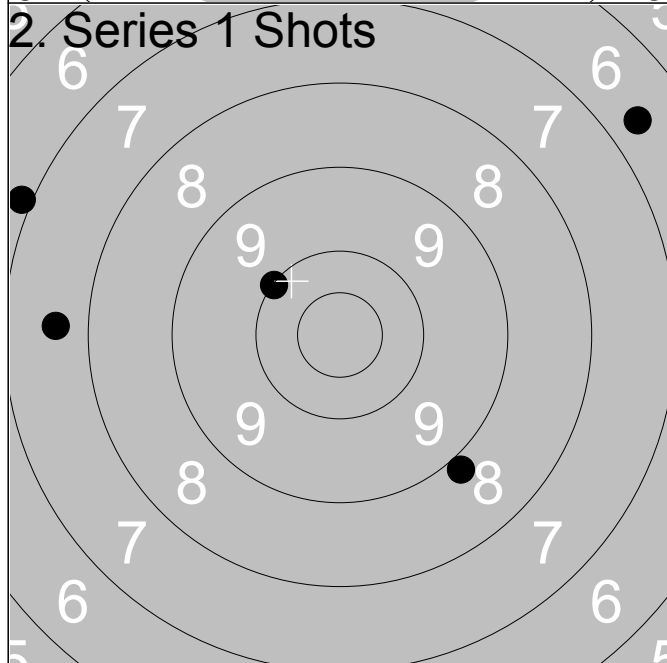

1:	7.6	←
2:	6.9	↙
3:	6.7	➔
4:	10.0	↗
5:	8.9	➔
Series		37.0
Total		291.0

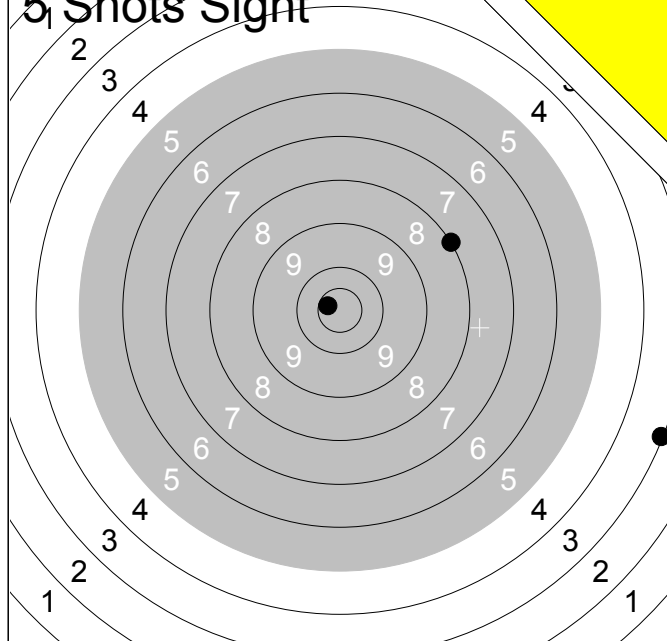

1:	3.1	➔
2:	*10.7	➔
3:	8.0	➔
<hr/>		
Series		21.0
Total		214.0

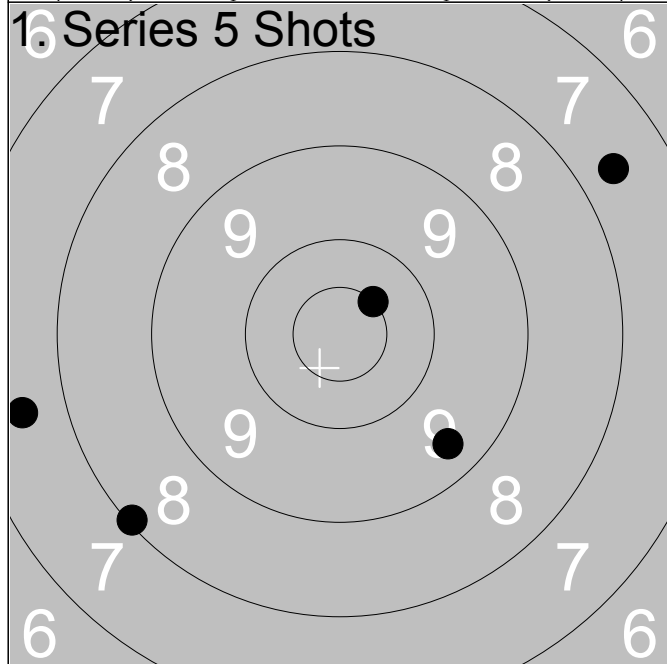

1:	7.6	➔
2:	*10.5	➔
3:	9.4	➔
4:	7.6	➔
5:	8.1	➔
<hr/>		
Series		41.0
Total		255.0

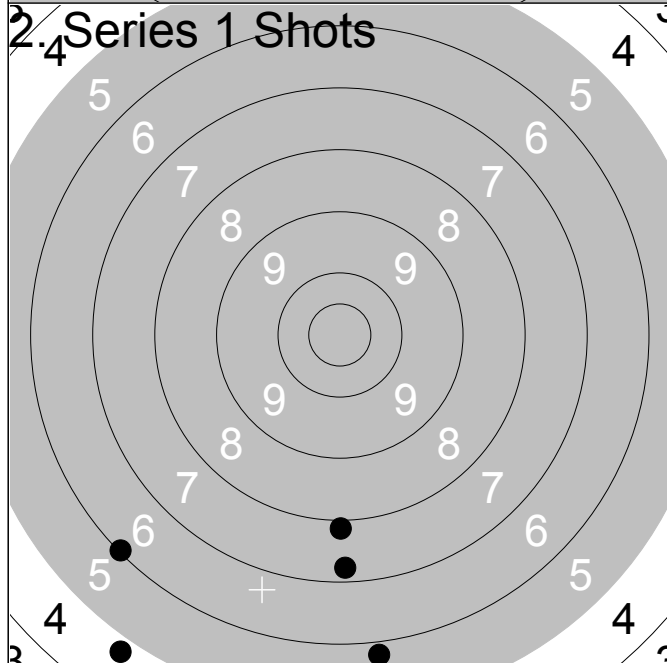

1:	6.1	➔
2:	5.8	➔
3:	4.8	➔
4:	7.9	➔
5:	7.3	➔
<hr/>		
Series		29.0
Total		284.0



1:	7.5	↘
2:	8.1	→
3:	6.7	→
Series	21.0	
Total	212.0	

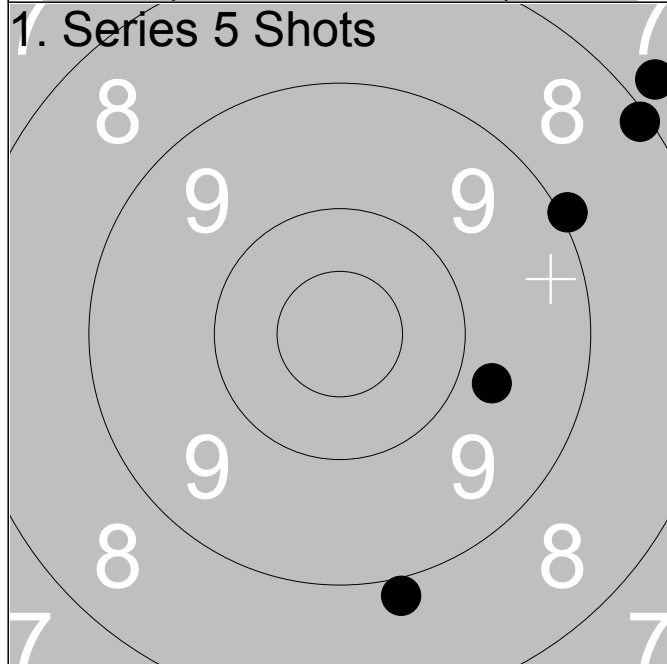

1:	8.9	↓
2:	9.0	↗
3:	9.8	→
4:	8.1	↗
5:	7.8	↗
Series	41.0	
Total	253.0	

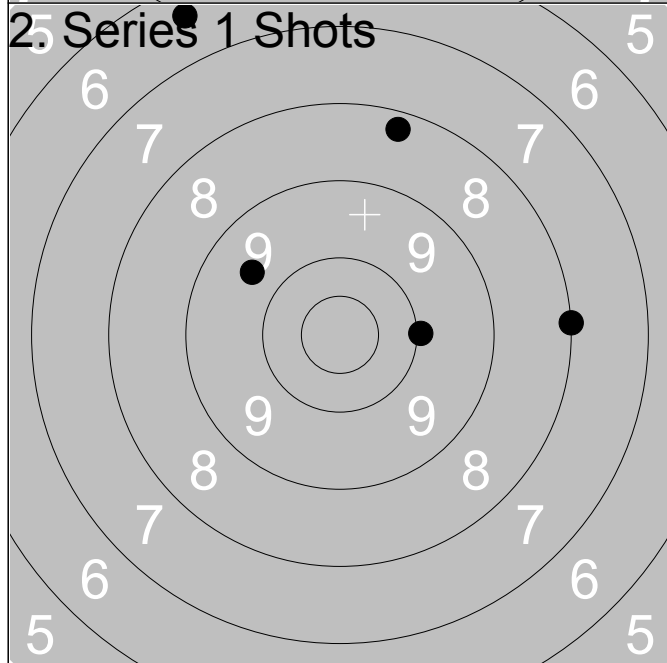

1:	6.4	↖
2:	9.6	↖
3:	10.0	→
4:	8.0	→
5:	8.3	↑
Series	41.0	
Total	294.0	