

Relay 4	Lane 1	Nils Ström	
-------------------	------------------	-------------------	--

300m	Övertorneå	E	No
------	------------	---	----

2013-07-08	Tavelträffen B 2013	Ramselefors SKF
------------	---------------------	-----------------

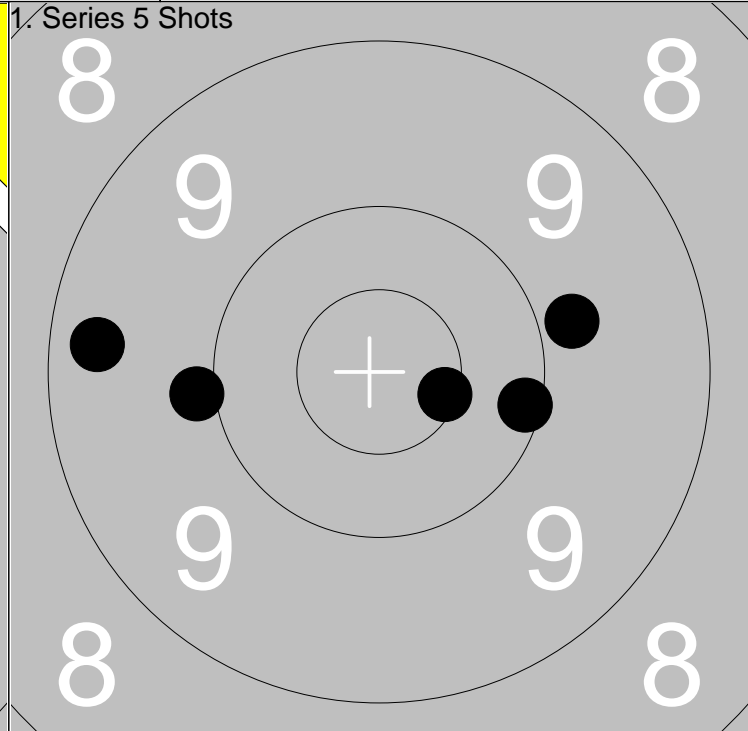
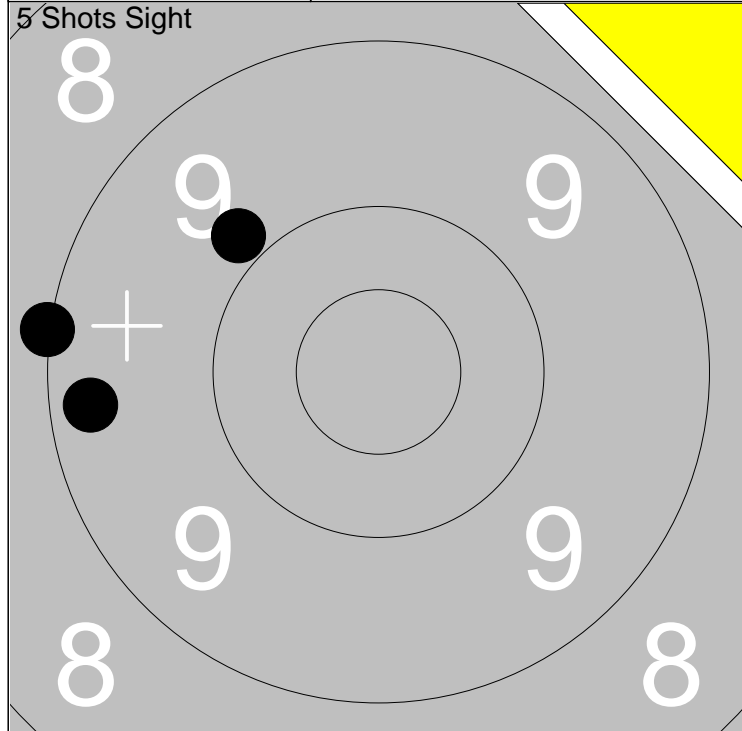

1: 9.8 ↗	Series 27.0
2: 9.0 ←	
3: 9.3 ←	
Total 285.0	

1: 9.8 →	Series 47.0
2: 9.3 ←	
3: *10.6 →	
4: 10.1 →	Total 332.0
5: 9.9 ←	

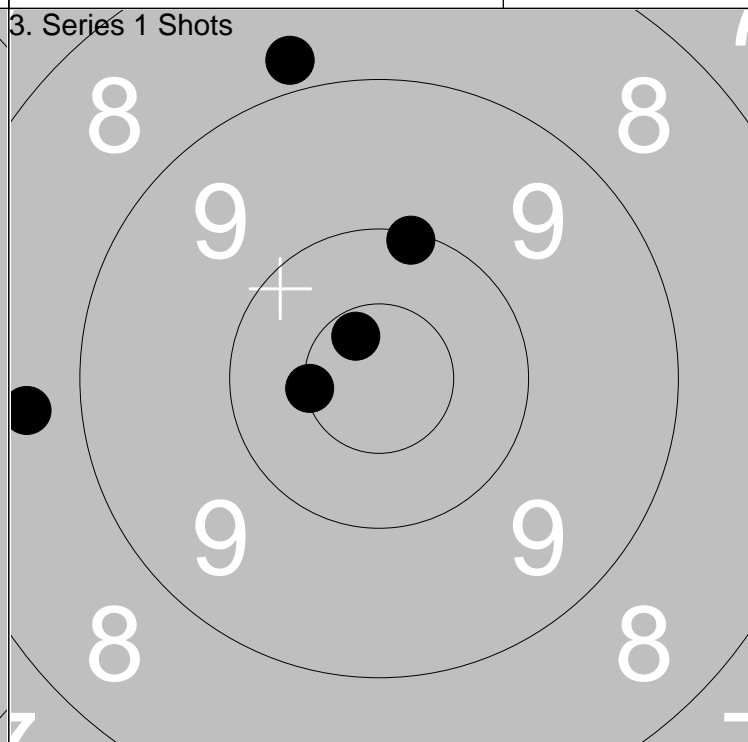
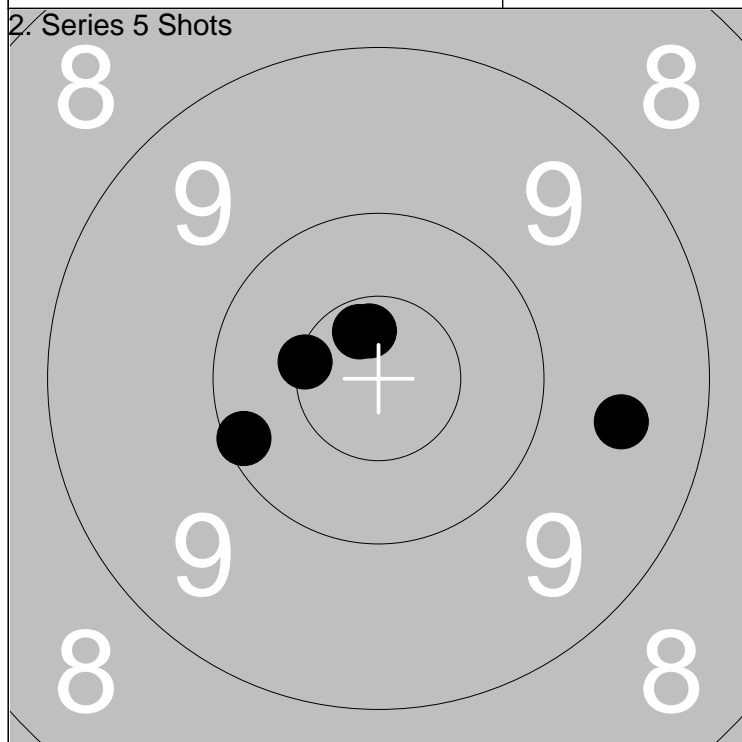

1: *10.5 ←	Series 49.0
2: 10.1 ←	
3: *10.7 ↗	
4: *10.7 ↑	Total 381.0
5: 9.5 →	

1: *10.7 ↗	Series 46.0
2: 8.8 ↑	
3: *10.5 ←	
4: 8.7 ←	Total 427.0
5: 10.1 ↑	

Relay 4	Lane 2	Victor Isaksson	
-------------------	------------------	------------------------	--

300m	Loos	E	Gä
------	------	---	----

2013-07-08	Tavelträffen B 2013	Ramselefors SKF
------------	---------------------	-----------------

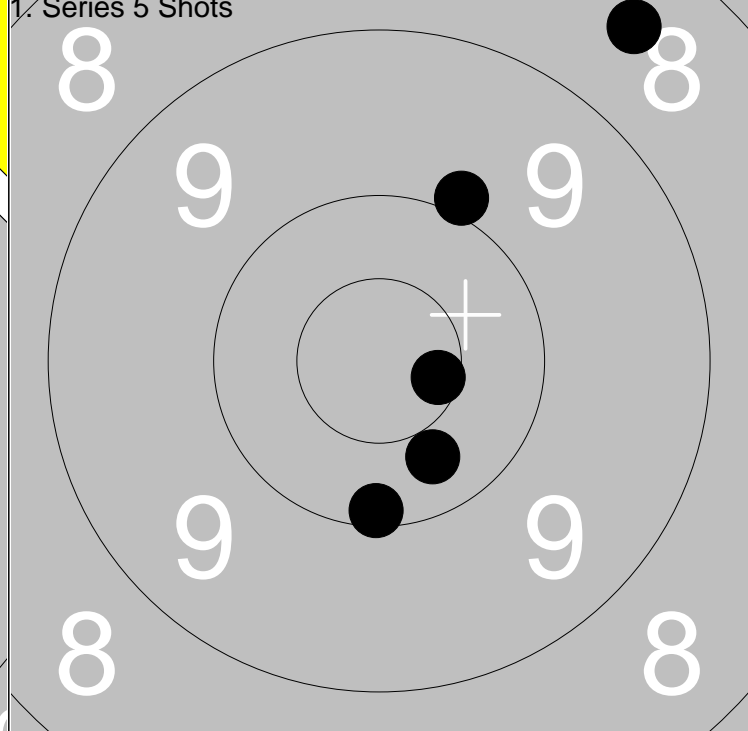
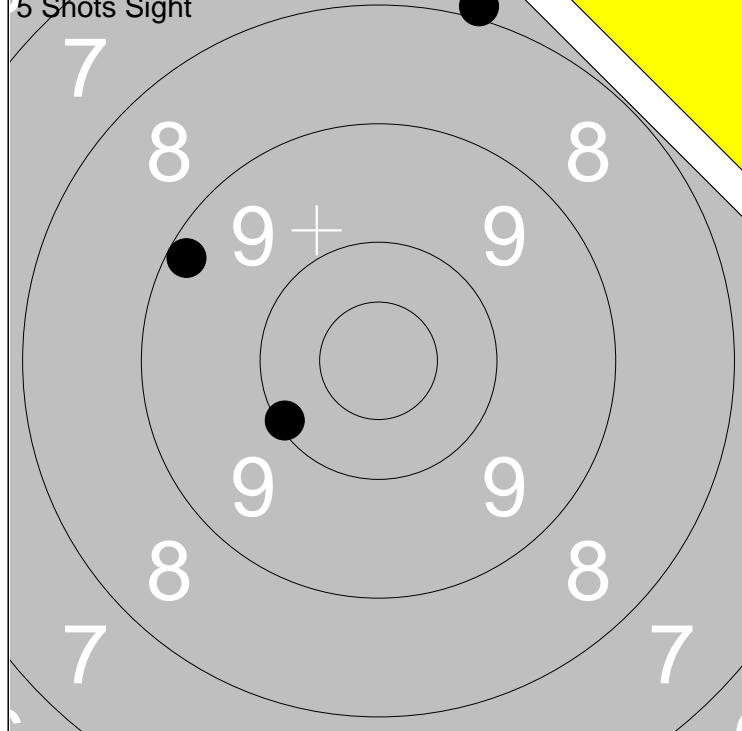

1: 10.1 ↙	Series	26.0
2: 9.2 ↖		
3: 7.9 ↗		
Total		279.0

1: *10.6 ➔	Series	47.0
2: 10.1 ↓		
3: 9.9 ↗		
4: 10.3 ↘		
5: 8.5 ↗		
Total		326.0

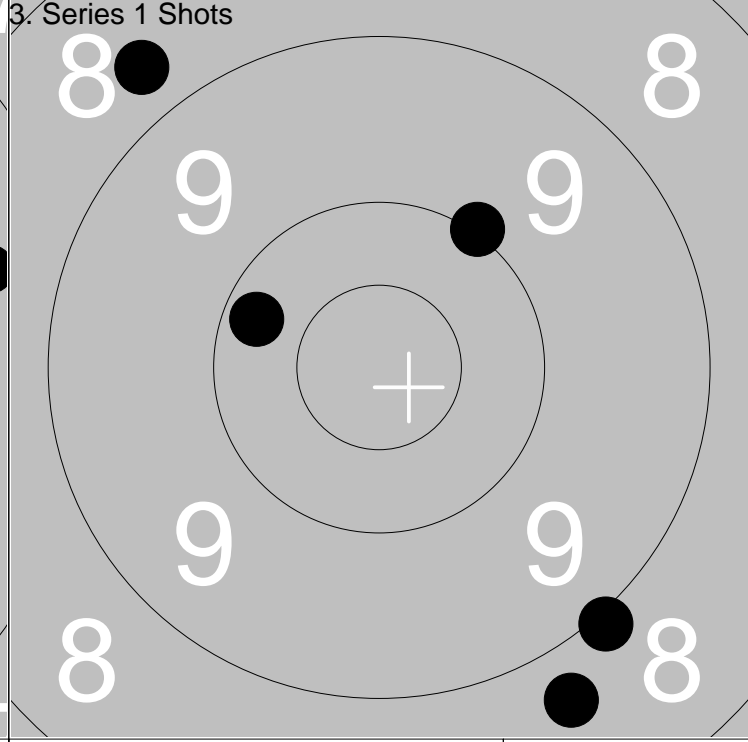
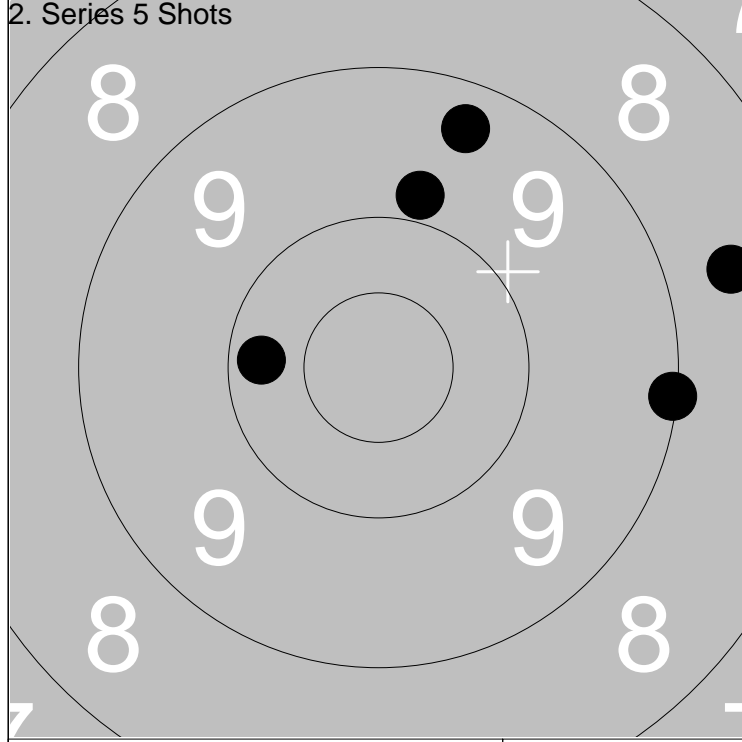

1: 9.8 ↗	Series	45.0
2: 10.2 ←		
3: 9.1 ➔		
4: 8.6 ➔		
5: 9.3 ↗		
Total		371.0

1: 8.7 ↘	Series	45.0
2: 9.0 ↘		
3: 10.0 ↗		
4: 8.7 ↖		
5: 10.2 ↖		
Total		416.0

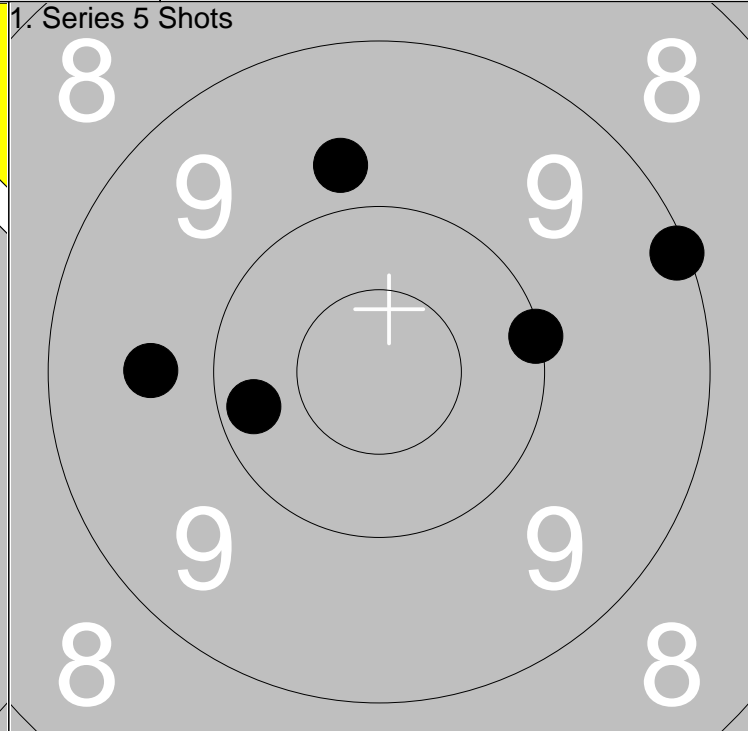
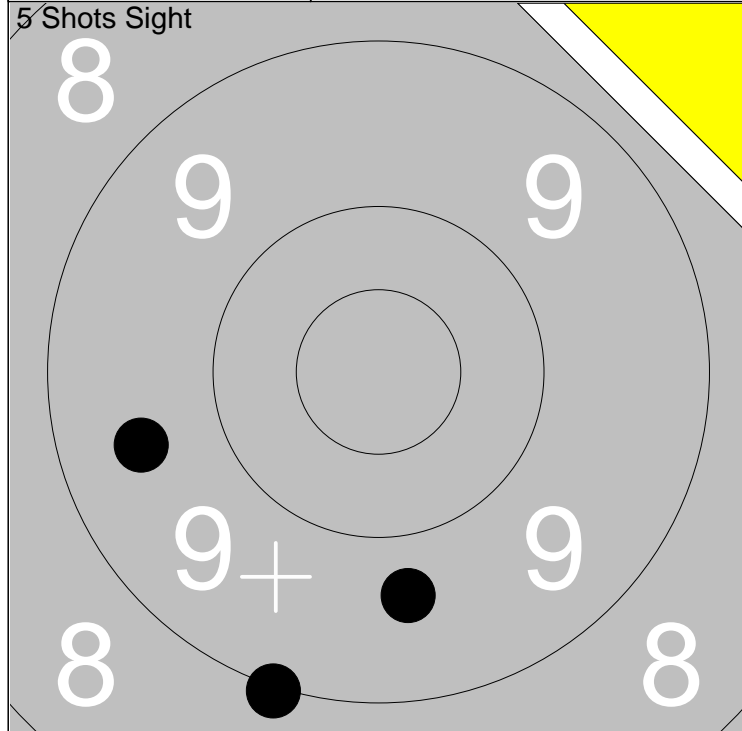

1: 9.7 ↓	Series	27.0
2: 9.5 ←		
3: 9.0 ↓		
Total		278.0

1: 10.2 ←	Series	47.0
2: 9.6 ←		
3: 10.1 →		
Total		325.0

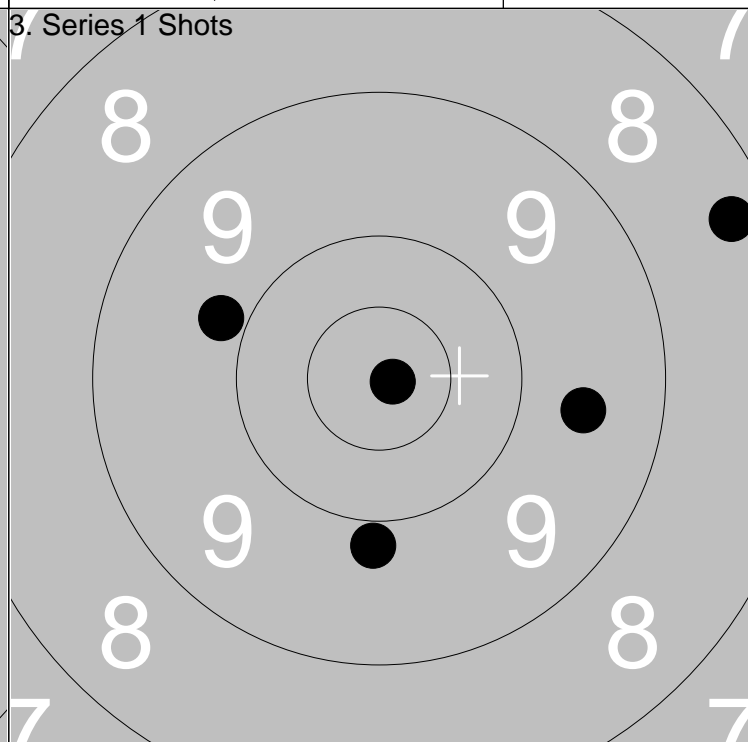
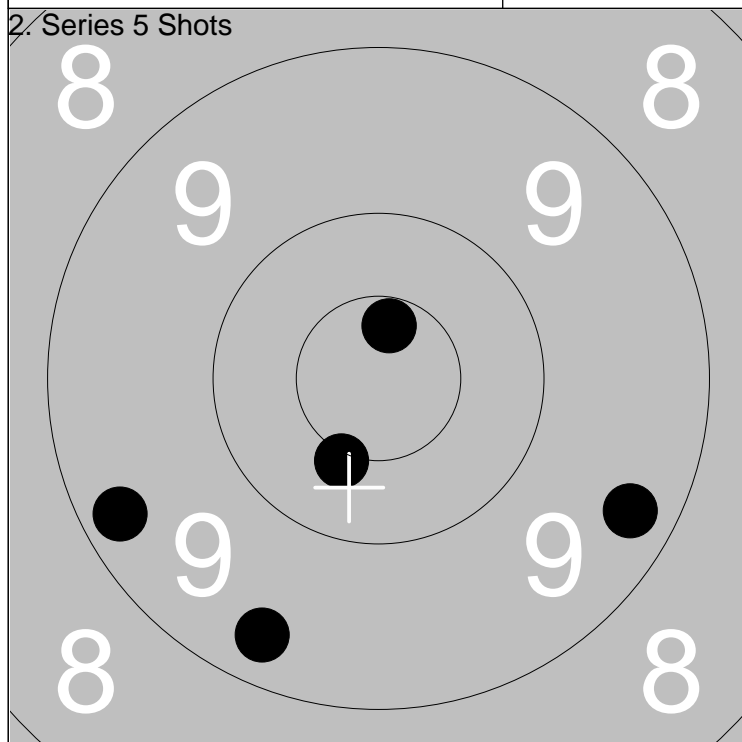

1: 9.3 ↓	Series	47.0
2: *10.6 ↑		
3: *10.4 ↓		
Total		372.0

1: 8.3 →	Series	45.0
2: 9.6 →		
3: 9.8 ←		
Total		417.0

Relay 4	Lane 4	Leif Sigfridsson	
-------------------	------------------	-------------------------	--

300m	Ramselefors	E	Vb
------	-------------	---	----

2013-07-08	Tavelträffen B 2013	Ramselefors SKF
------------	---------------------	-----------------

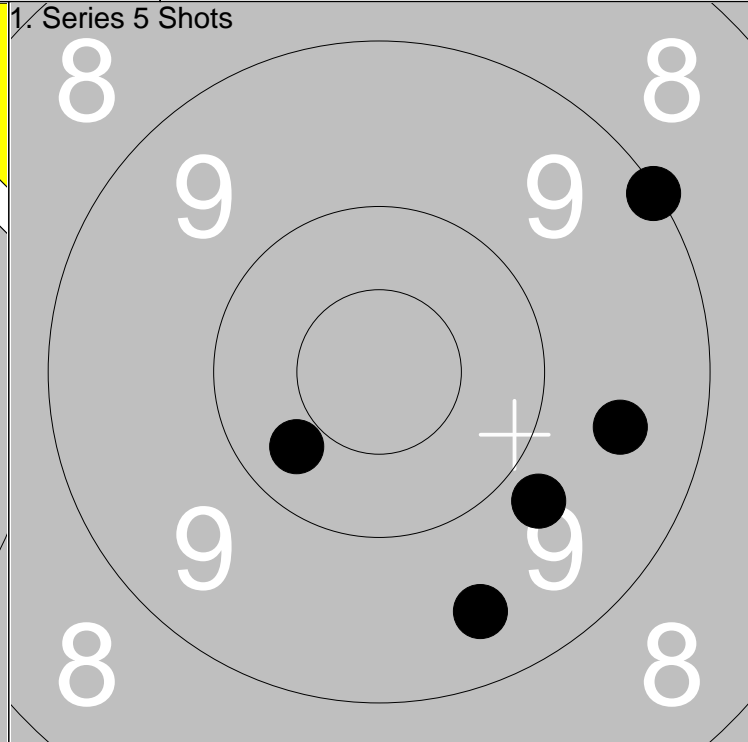
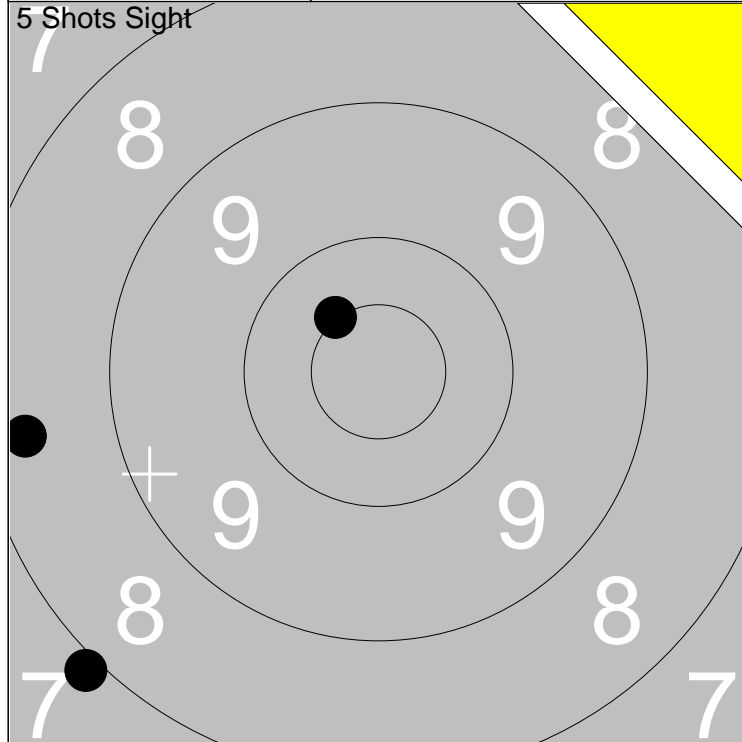

1: *10.5 ↖
2: 8.4 ←
3: 7.9 ↙

Series	25.0
Total	272.0

1: 9.1 ↗
2: 9.8 ↘
3: 9.5 →
4: 9.5 ↓
5: 10.3 ↙

Series	46.0
Total	318.0

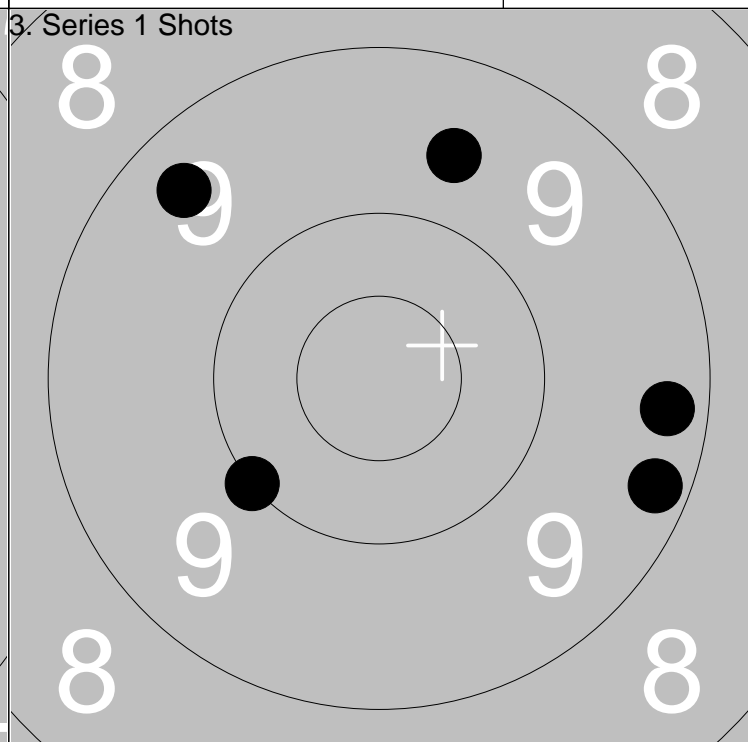
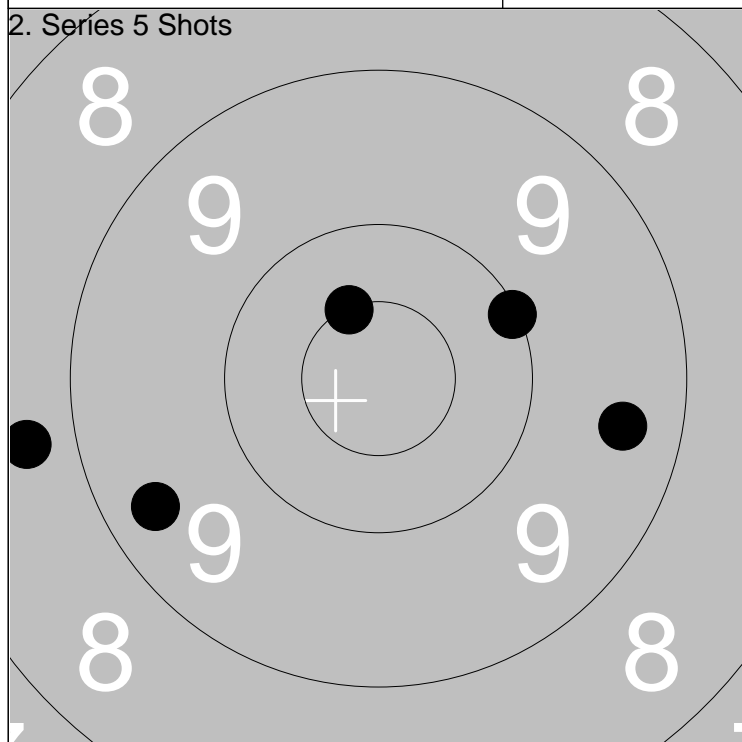

1: 10.1 ↗
2: 9.4 →
3: *10.5 ↖
4: 8.7 ←
5: 9.4 ↙

Series	46.0
Total	364.0

1: 9.2 ↗
2: 9.3 →
3: 9.6 ↑
4: 9.4 ↖
5: 10.0 ↙

Series	46.0
Total	410.0

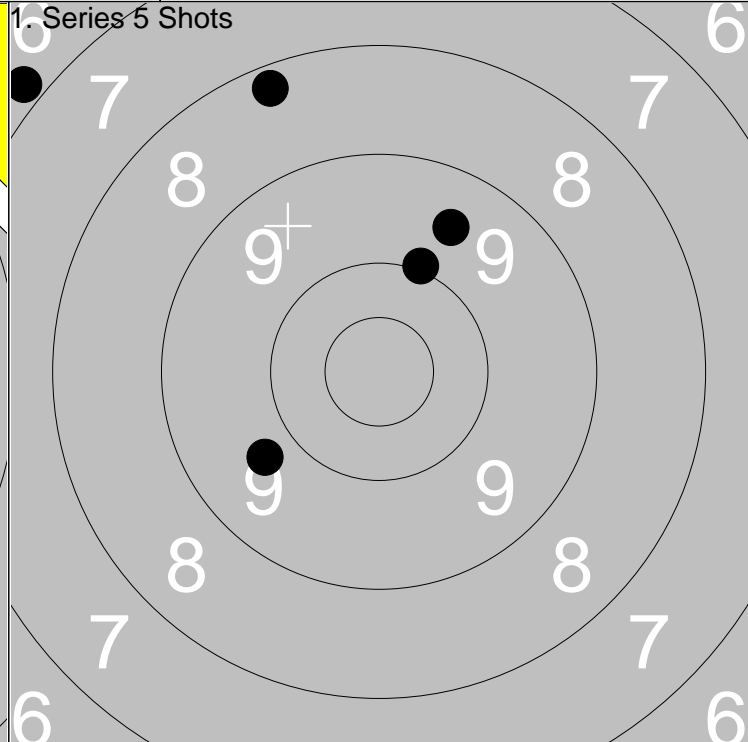
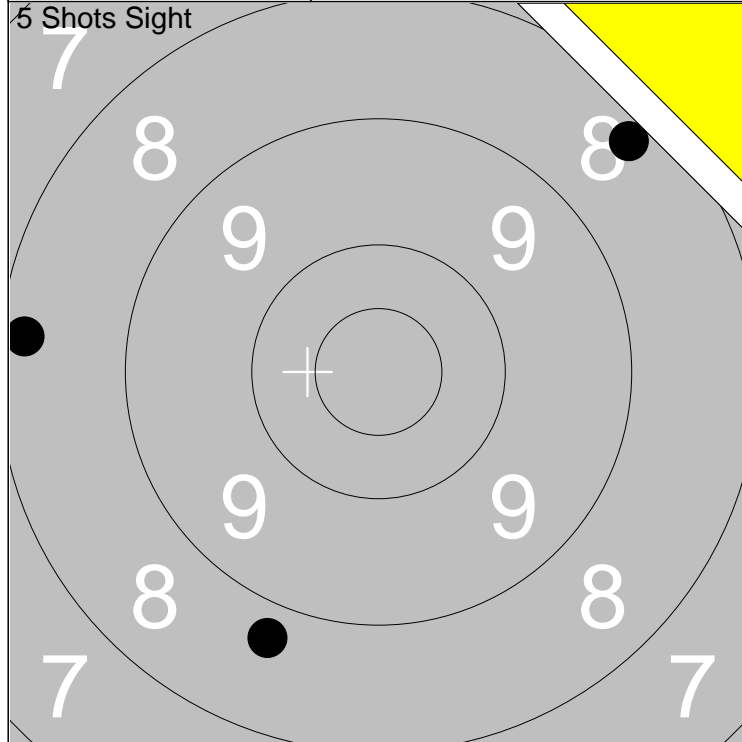

1: 8.2 ←	Series	24.0
2: 8.8 ↓		
3: 8.3 ↗		
Total		271.0

1: 8.2 ↖	Series	42.0
2: 9.5 ↗		
3: 10.0 ↗		
Total		313.0

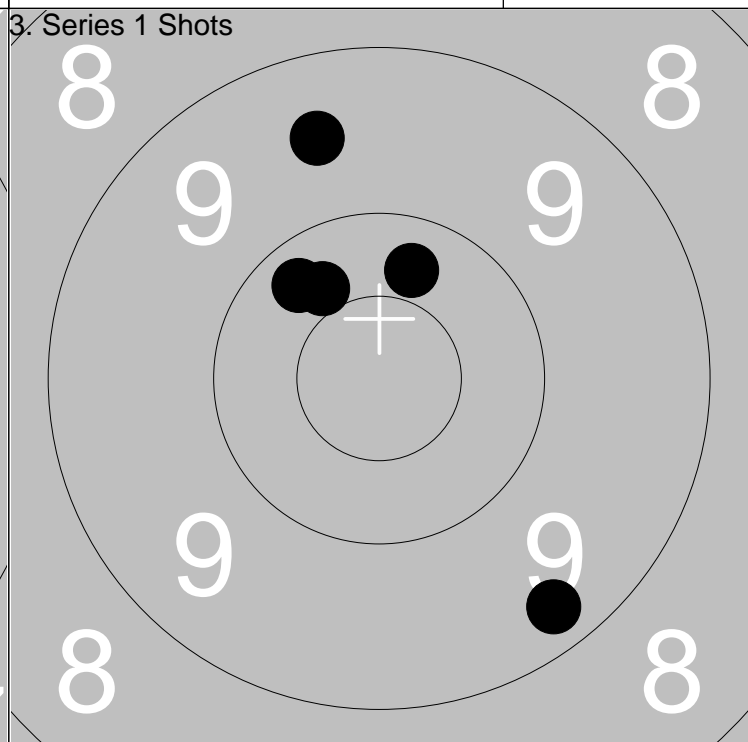
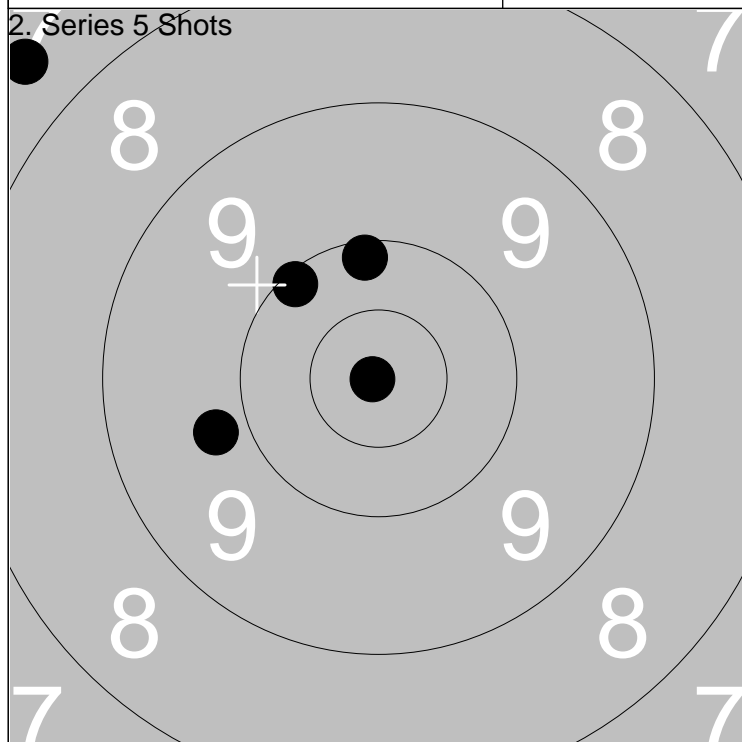

1: 10.1 ↖	Series	46.0
2: 10.1 ↑		
3: 9.8 ←		
Total		359.0

1: 10.4 ↖	Series	48.0
2: 9.3 ↓		
3: 10.3 ↖		
Total		407.0

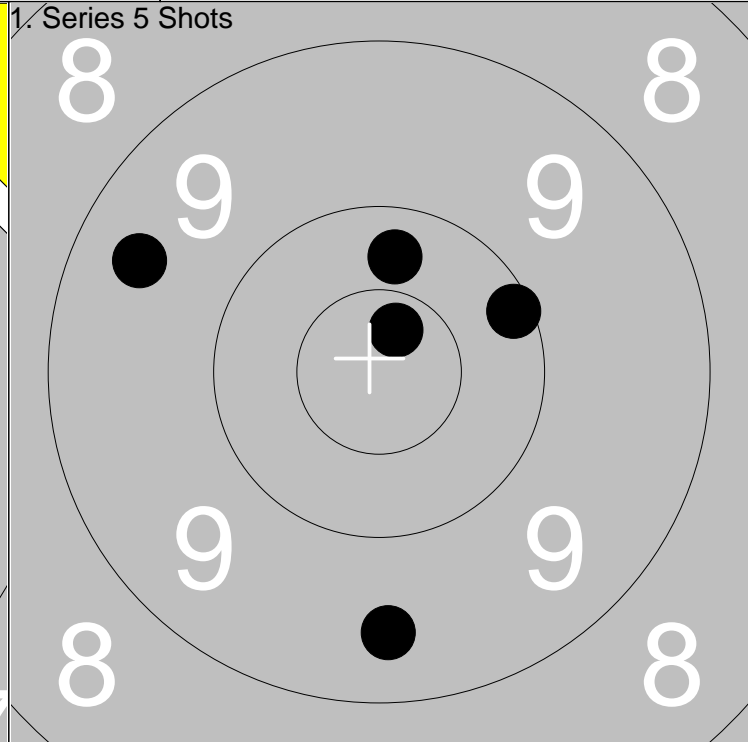
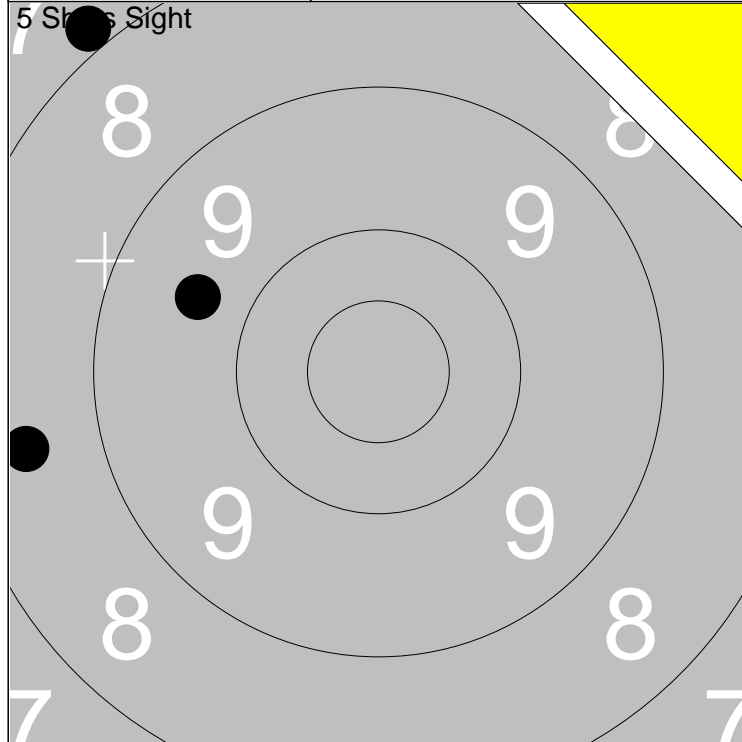

1: 9.7 ↙		Series 24.0
2: 8.5 ↙		Total 266.0
3: 7.9 ↗		

1: 9.5 ↓		Series 48.0
2: 9.4 ↙		Total 314.0
3: 10.3 ↑		
4: *10.7 ↗		
5: 10.1 ↘		

1: 9.5 ↓		Series 48.0
2: 9.4 ↙		Total 314.0
3: 10.3 ↑		
4: *10.7 ↗		
5: 10.1 ↘		

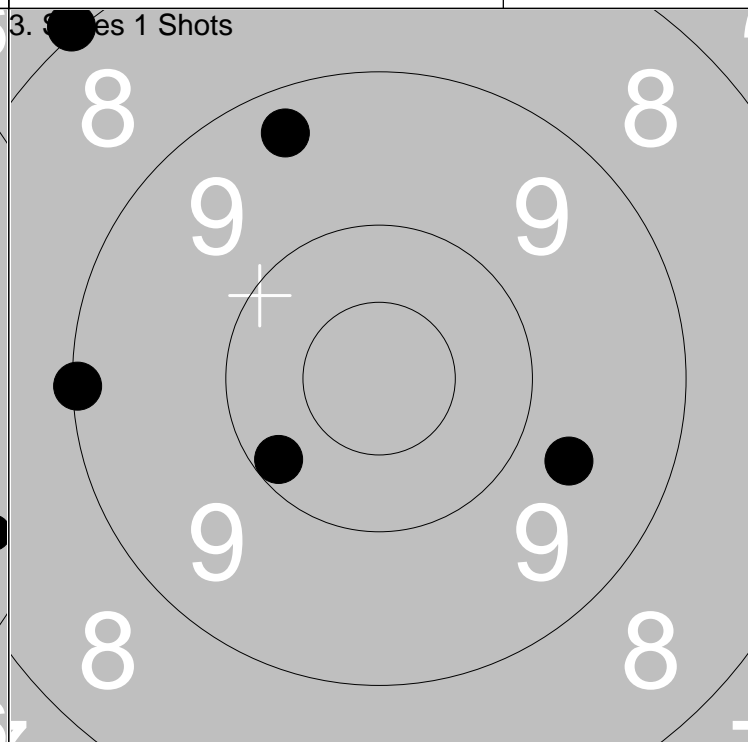
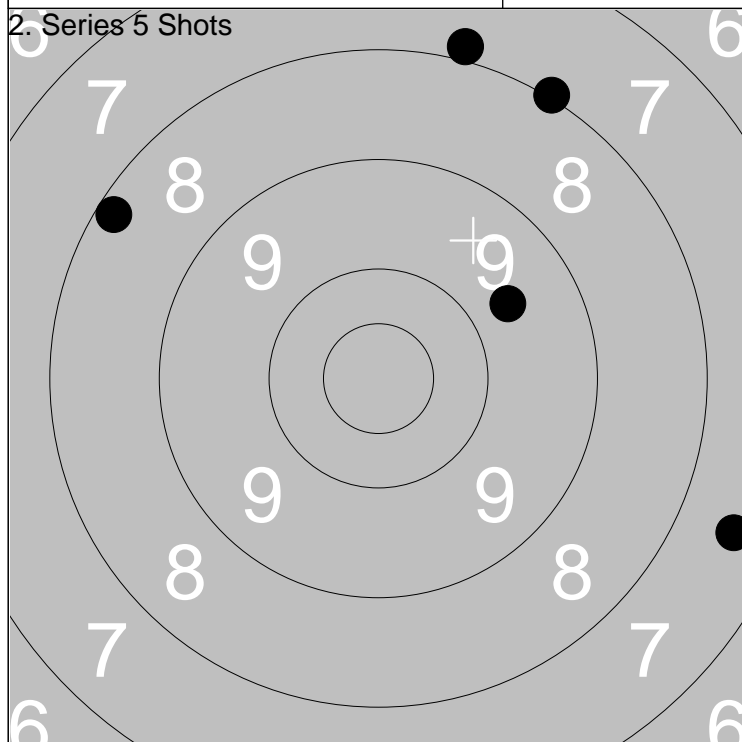

1: 7.9 ↑		Series 39.0
2: 7.5 ➡		Total 353.0
3: 8.0 ↗		
4: 9.7 ↘		
5: 8.2 ↙		

1: 9.3 ↗		Series 45.0
2: 9.7 ➡		Total 398.0
3: 9.1 ↙		
4: 8.0 ↙		
5: 10.2 ↘		

1: 9.3 ↗		Series 45.0
2: 9.7 ➡		Total 398.0
3: 9.1 ↙		
4: 8.0 ↙		
5: 10.2 ↘		

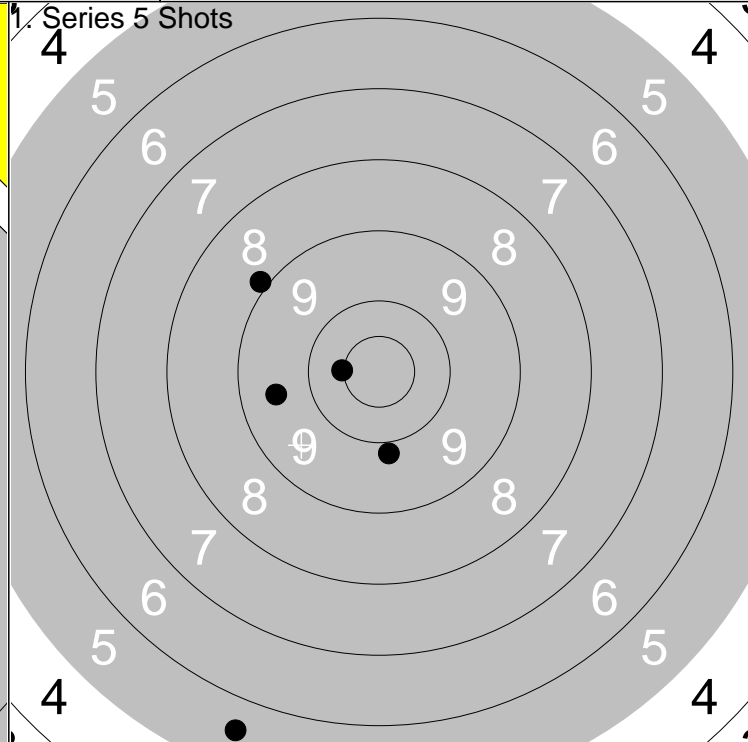
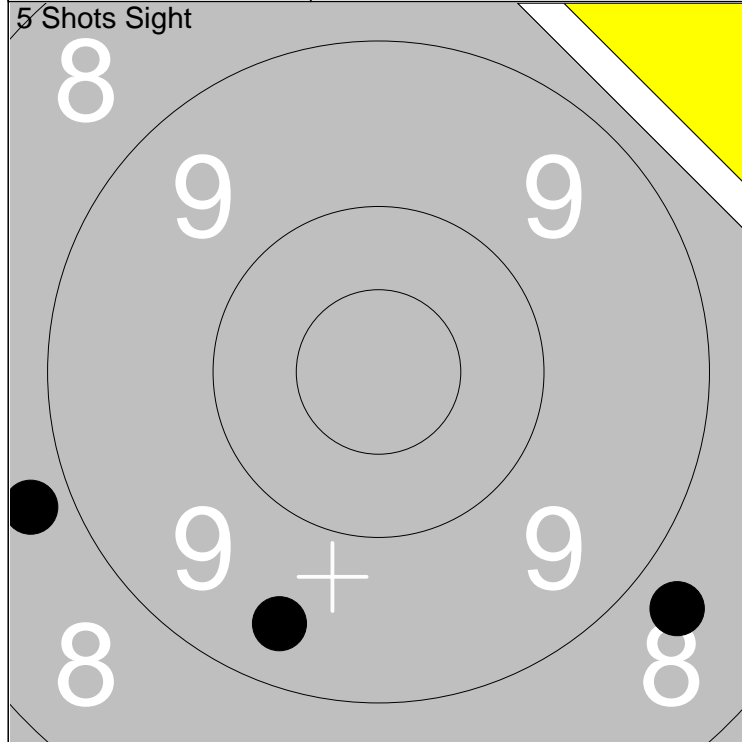

1: 9.4 ↘	Series	25.0
2: 8.7 ↘		
3: 8.8 ←		
Total		238.0

1: 5.6 ↘	Series	41.0
2: *10.5 ←		
3: 9.9 ↘		
4: 8.9 ↖		
5: 9.5 ←		
Total		279.0

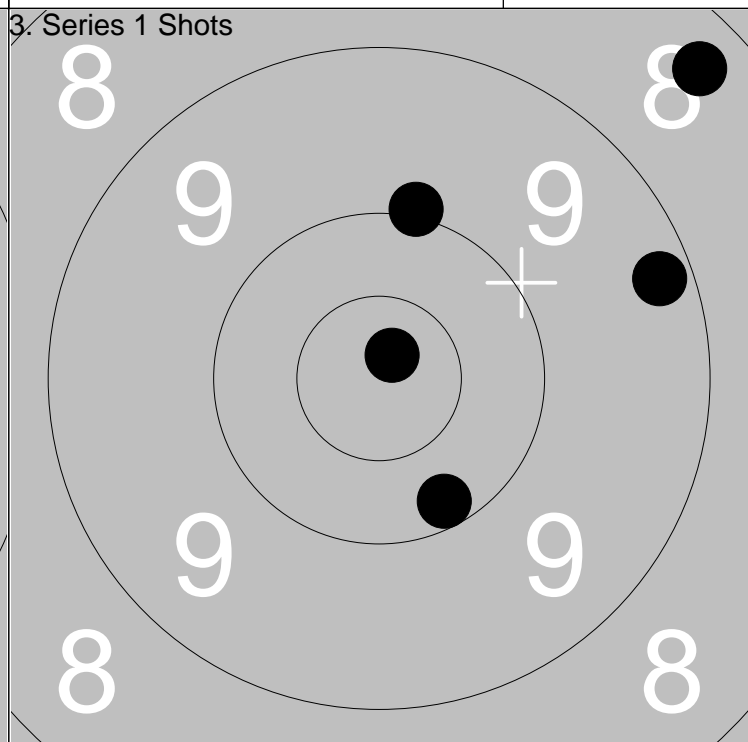
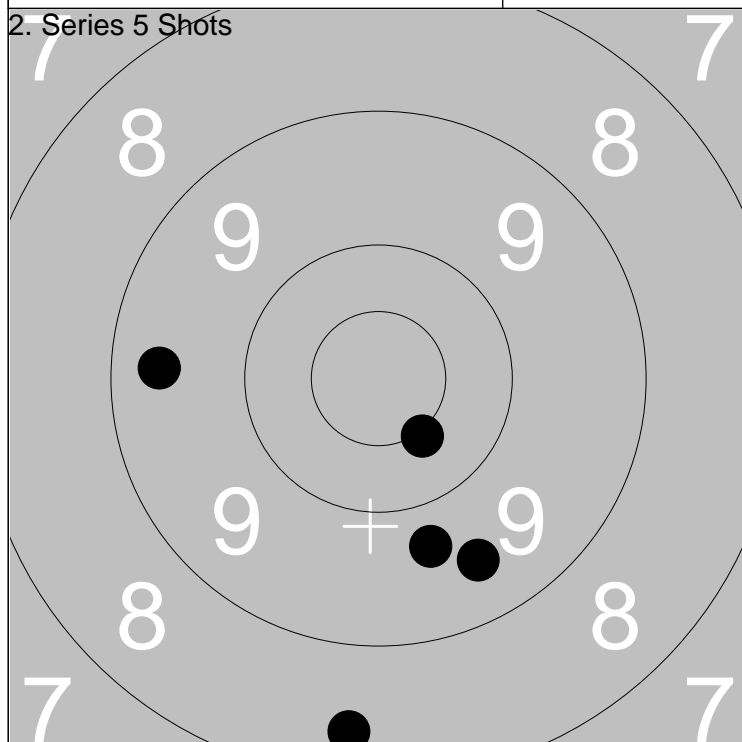

1: 9.7 ↘	Series	45.0
2: 9.4 ←		
3: 9.5 ↘		
4: 8.4 ↘		
5: *10.4 ↘		
Total		324.0

1: 8.3 ↗	Series	47.0
2: 9.2 →		
3: 10.0 ↑		
4: 10.2 ↘		
5: *10.8 ↗		
Total		371.0

Relay 4	Lane 9	Ella Carlsson	
-------------------	------------------	----------------------	--

300m	Ramsberg	U	Ör
------	----------	---	----

2013-07-08	Tavelträffen B 2013	Ramselefors SKF
------------	---------------------	-----------------

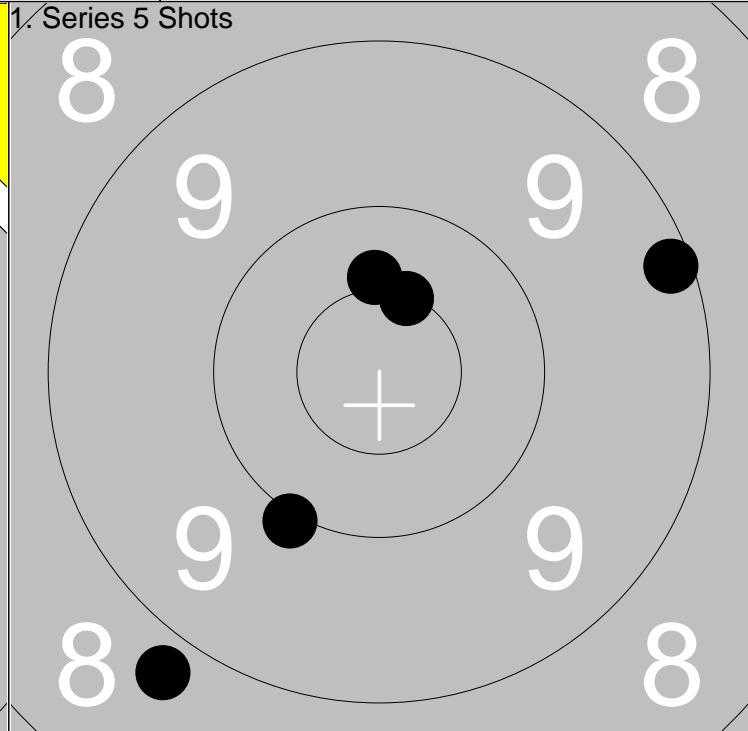
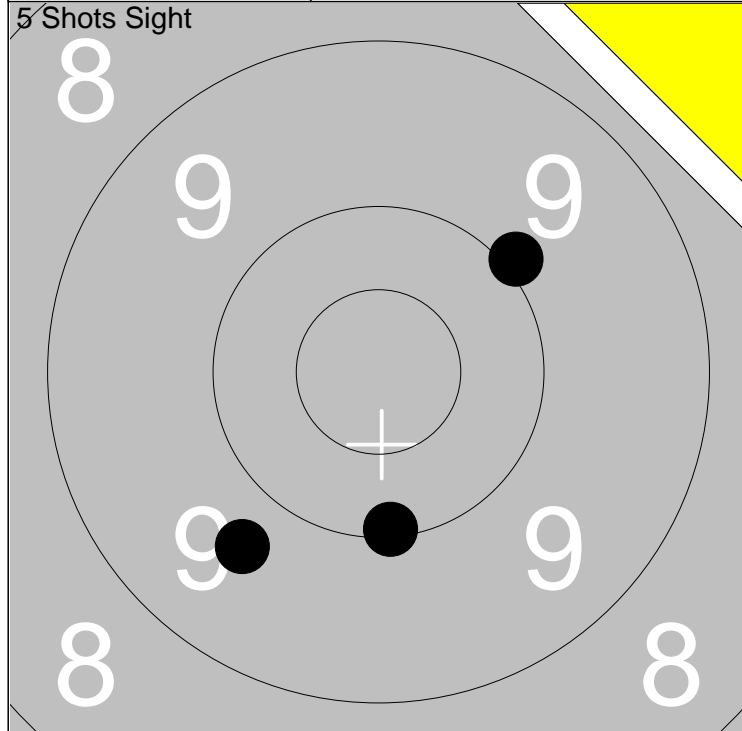

1: 9.7 ↙	Series	29.0
2: 10.1 ↓		
3: 10.0 ↗		
Total		291.0

1: 8.8 ↙	Series	47.0
2: 9.2 →		
3: *10.5 ↑		
4: *10.4 ↑		
5: 10.0 ↙		
Total		338.0

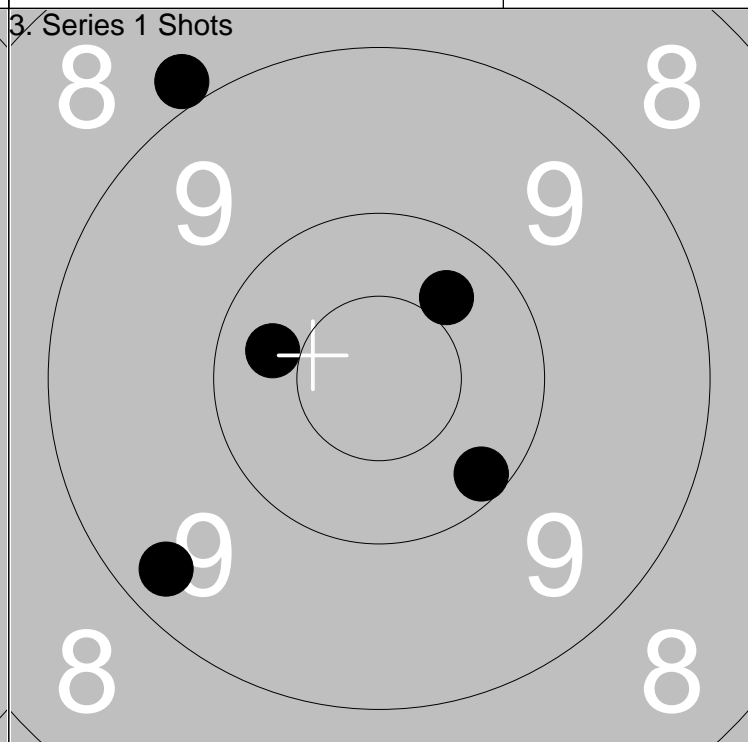
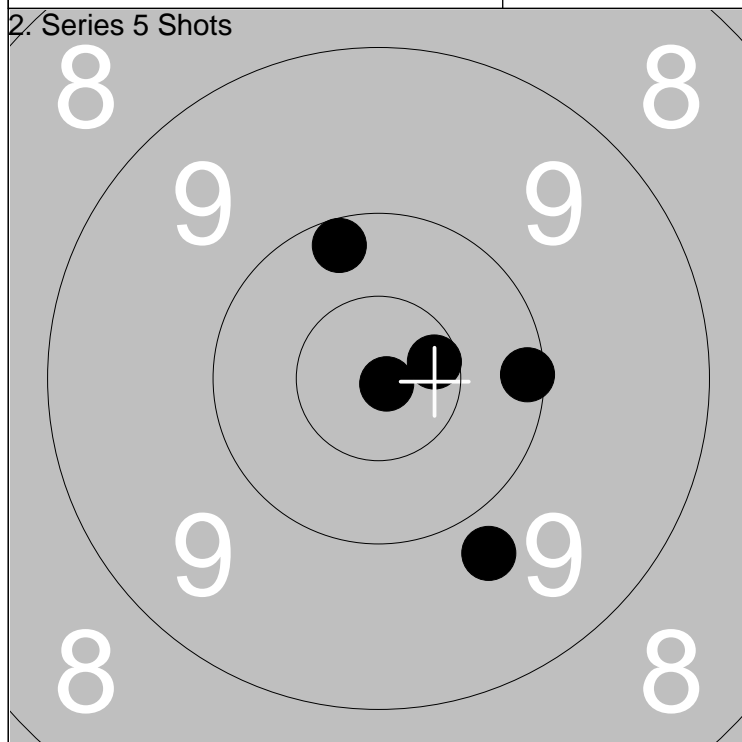

1: 10.1 →	Series	49.0
2: 10.2 ↑		
3: 9.8 ↙		
4: *10.9 ↘		
5: *10.6 →		
Total		387.0

1: 9.3 ↙	Series	47.0
2: 10.2 ↘		
3: 10.4 ↗		
4: 8.9 ↑		
5: 10.3 ←		
Total		434.0

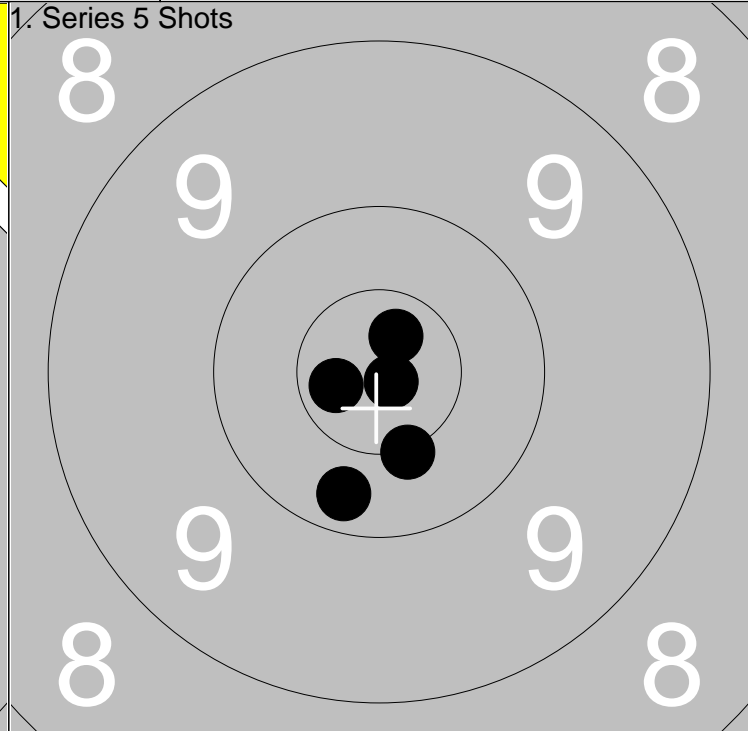

1: 9.2 ↑	Series	29.0
2: 10.3 ↑		
3: 10.1 ←		
Total		290.0

1: *10.7 ↑	Series	50.0
2: *10.9 ↘		
3: 10.2 ↓		
4: *10.5 ↓		
5: *10.7 ←		
Total		340.0

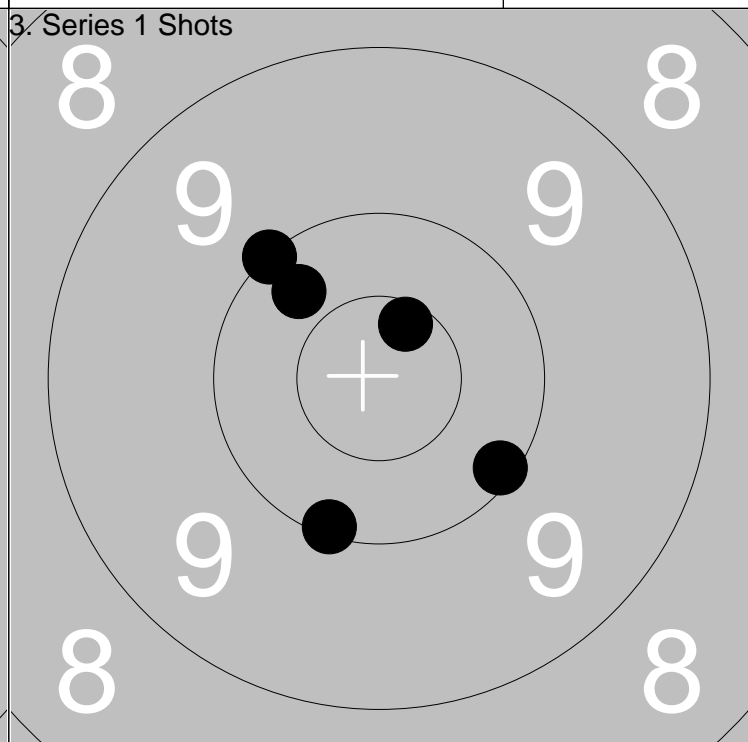
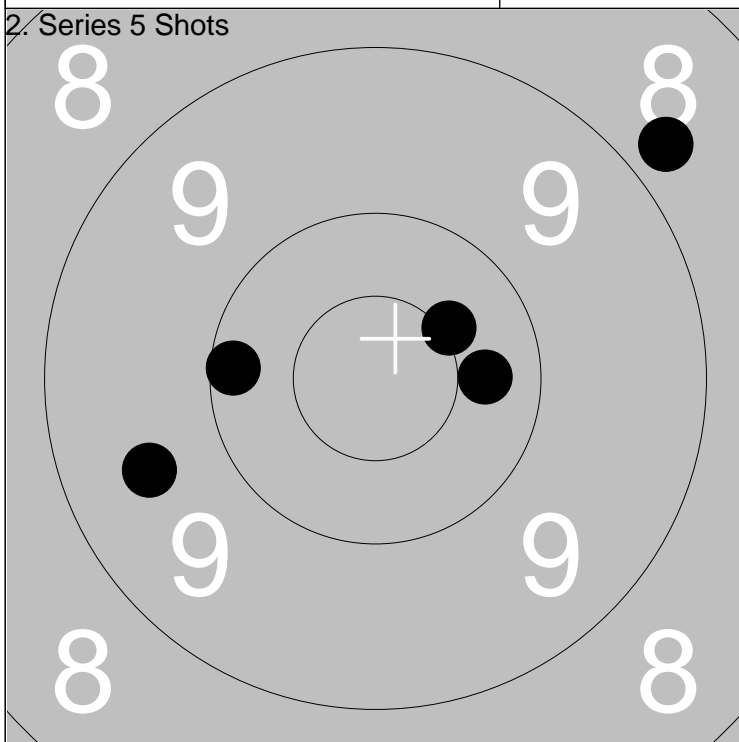

1: 10.3 →	Series	47.0
2: *10.5 ↗		
3: 8.8 ↗		
4: 9.6 ←		
5: 10.2 ←		
Total		387.0

1: 10.1 ↓	Series	50.0
2: 10.1 ↘		
3: *10.6 ↑		
4: 10.0 ↖		
5: 10.3 ↖		
Total		437.0

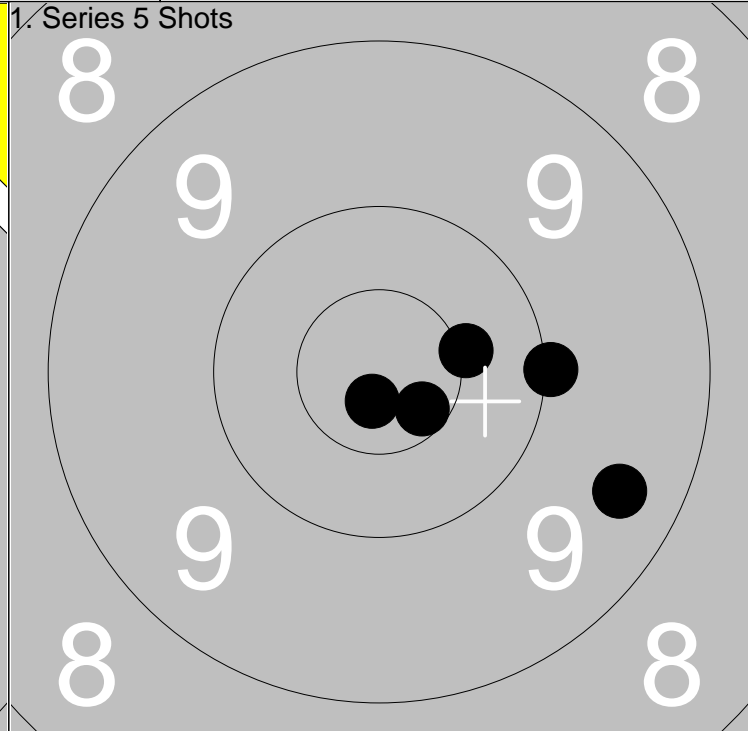
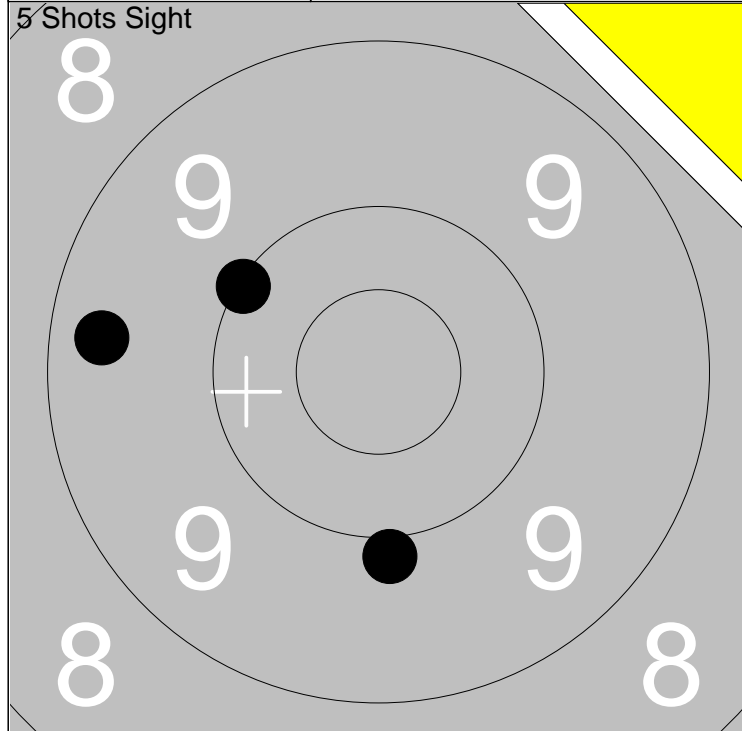

1: 9.3 ←	Series	28.0
2: 10.1 ↖		
3: 9.9 ↓		
Total		289.0

1: *10.4 →	Series	49.0
2: *10.6 ↘		
3: *10.8 ↓		
4: 10.0 →		
5: 9.4 ↘		
Total		338.0

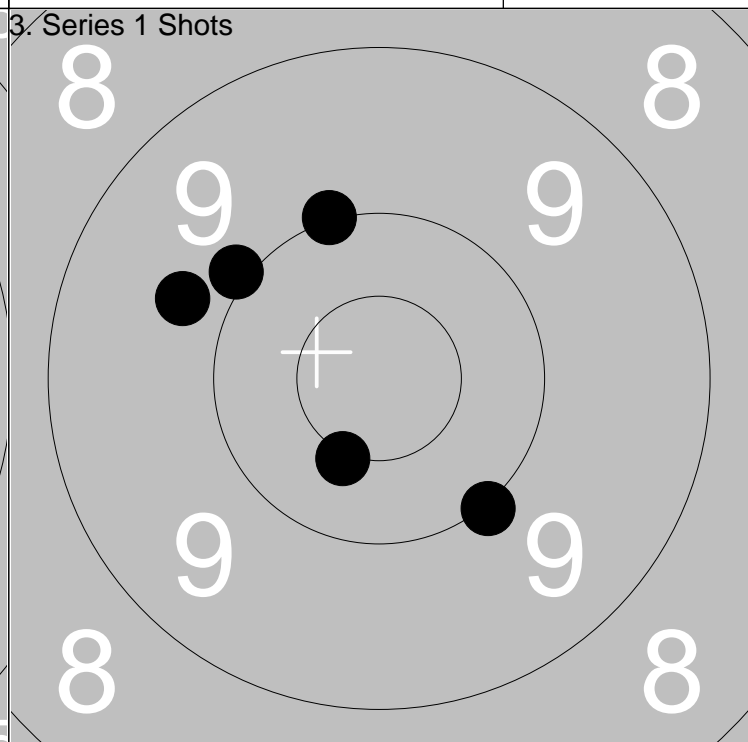
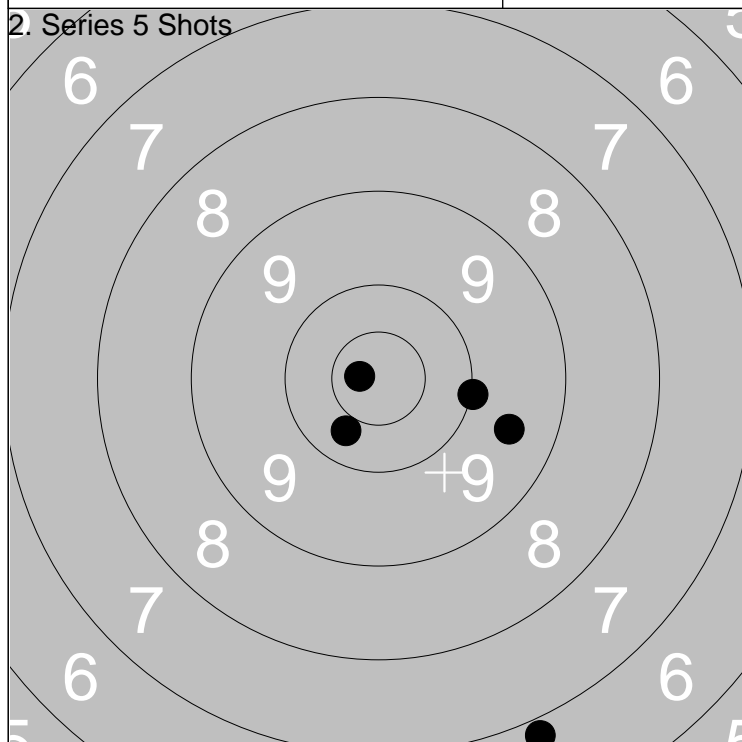

1: *10.8 ←	Series	45.0
2: 6.8 ↓		
3: 10.0 →		
4: 10.3 ↓		
5: 9.5 →		
Total		383.0

1: 9.7 ←	Series	49.0
2: 10.0 ↑		
3: *10.5 ↓		
4: 10.0 ↖		
5: 10.0 ↓		
Total		432.0

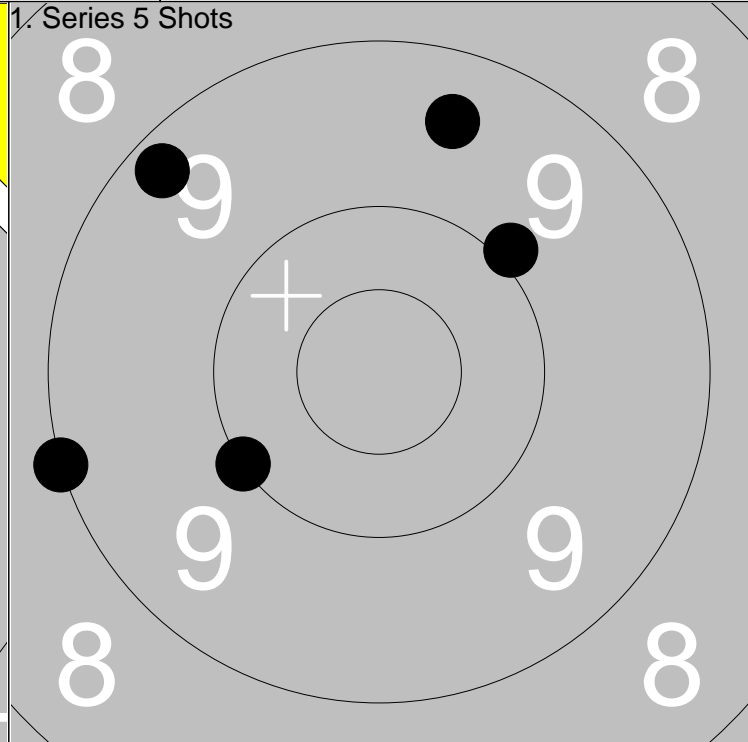
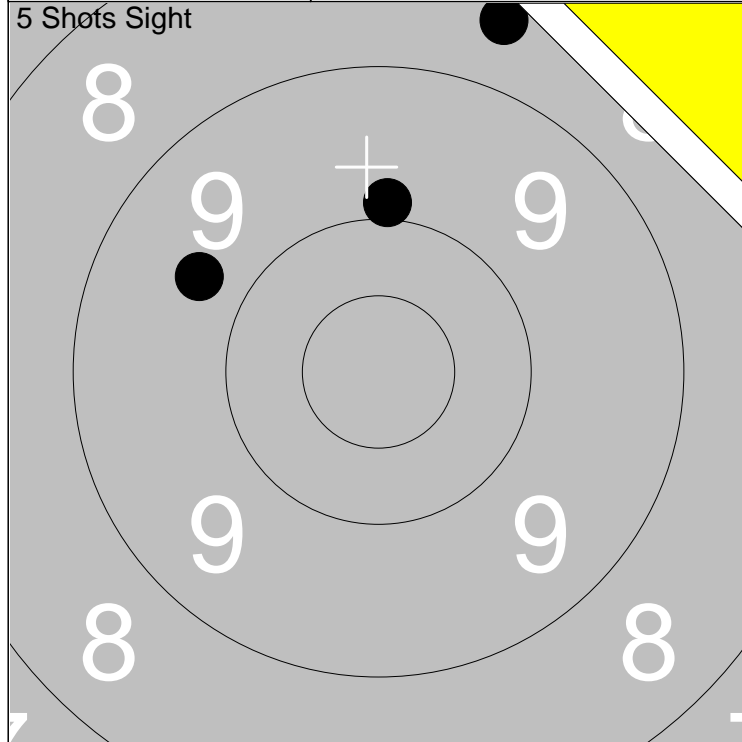

1: 9.7 ↙	Series 26.0
2: 9.9 ↑	
3: 8.6 ↑	
Total 286.0	

1: 9.5 ↑	Series 46.0
2: 9.9 ↗	
3: 10.0 ↙	
4: 9.2 ↖	
5: 9.0 ←	
Total 332.0	

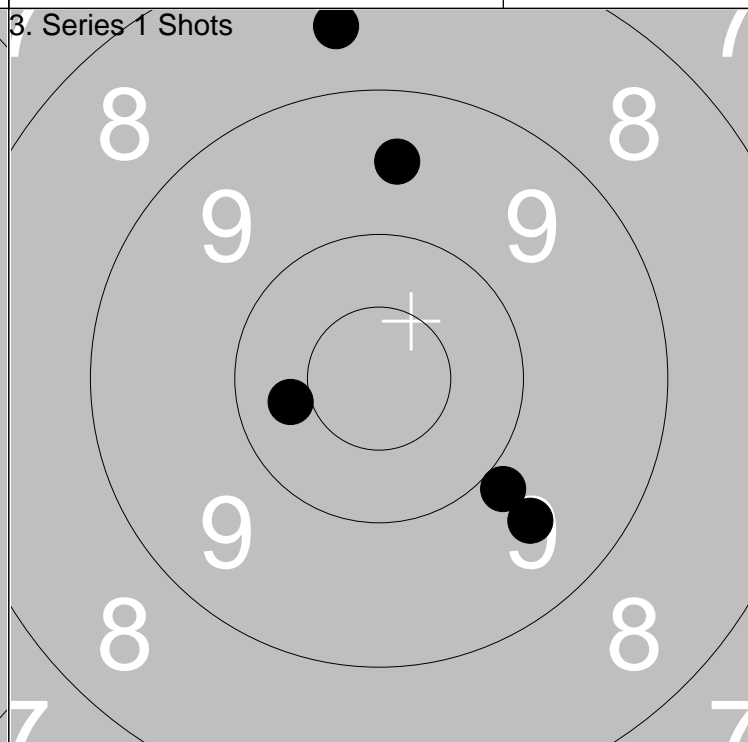
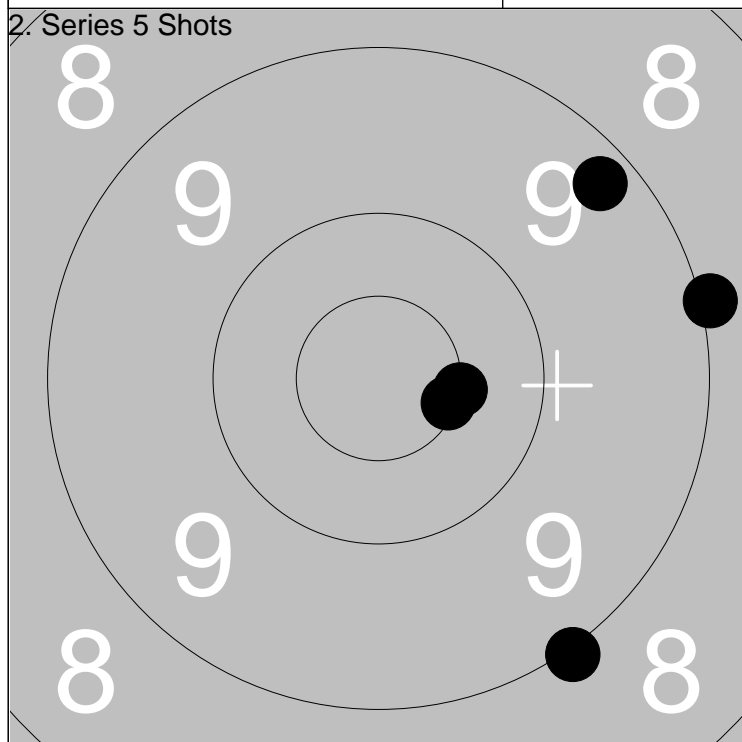

1: 9.0 ↘	Series 47.0
2: *10.5 →	
3: *10.5 →	
4: 9.0 →	
5: 9.2 ↗	
Total 379.0	

1: 9.5 ↑	Series 45.0
2: 9.9 ↘	
3: 9.6 ↘	
4: 8.6 ↑	
5: 10.4 ←	
Total 424.0	

Relay **4** Lane **13** **Evelina Isaksson**

300m Loos U Gä

2013-07-08 Tavelträffen B 2013 Ramselefors SKF

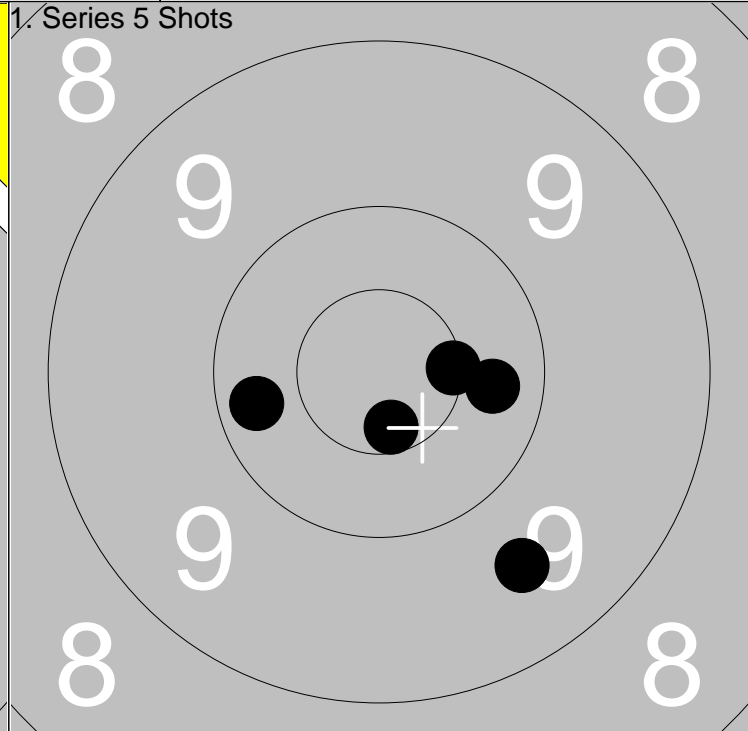
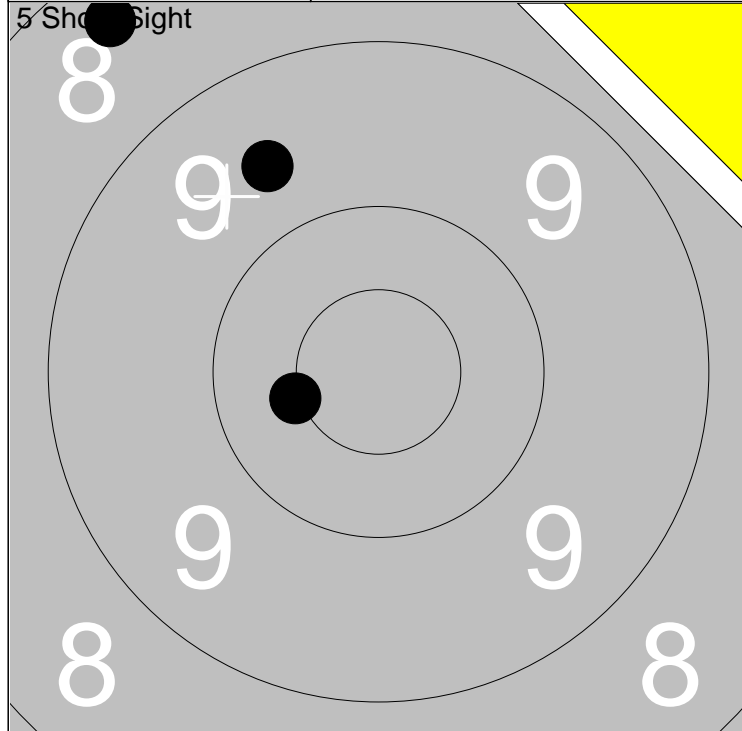

1: 8.4 ↗	Series 27.0
2: 9.6 ↗	
3: *10.5 ↙	
Total 283.0	

1: 10.2 ←	Series 49.0
2: *10.5 →	
3: 9.6 ↘	
4: 10.3 →	
5: *10.6 ↓	
Total 332.0	

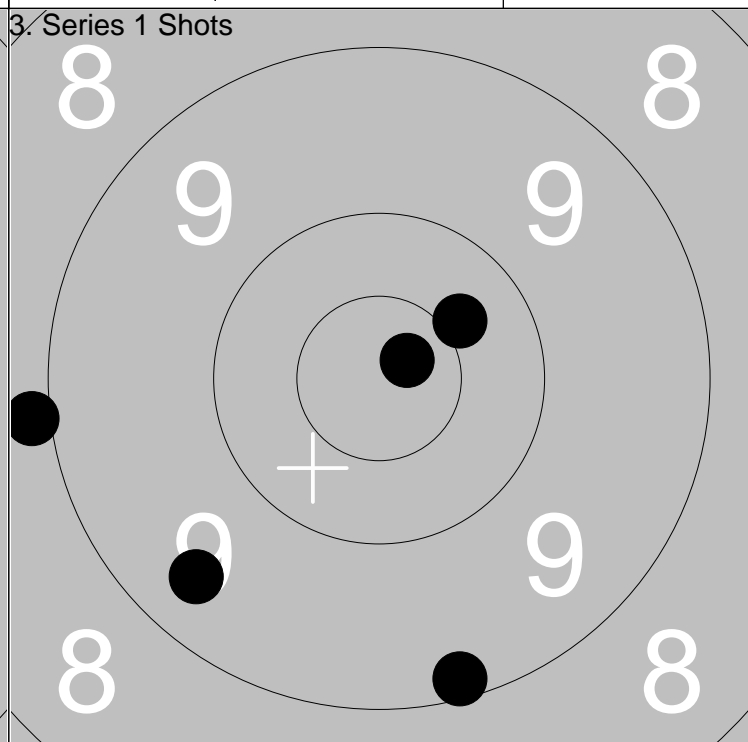
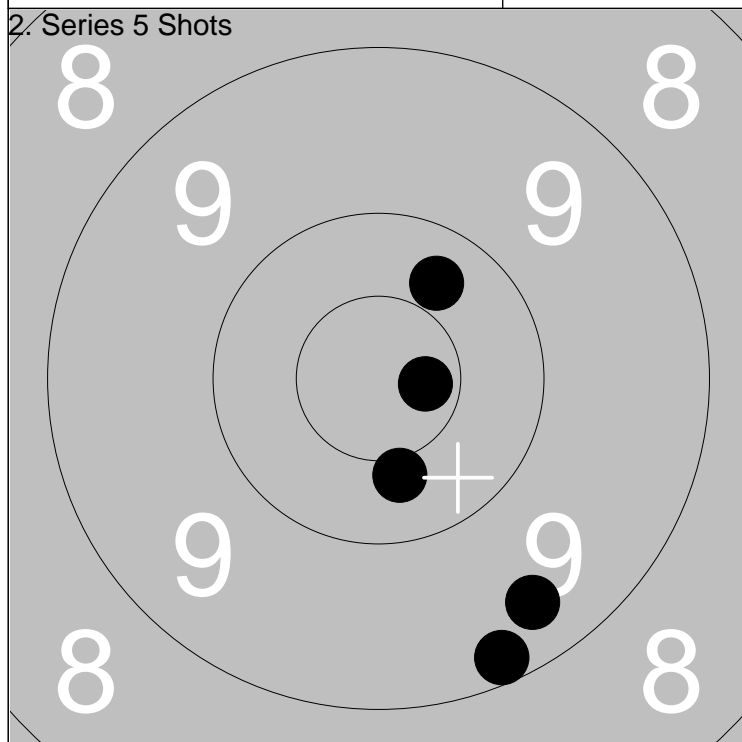

1: 9.4 ↘	Series 48.0
2: 10.3 ↗	
3: 10.4 ↘	
4: 9.2 ↘	
5: *10.7 →	
Total 380.0	

1: 10.4 ↗	Series 46.0
2: 9.2 ↘	
3: 9.4 ↘	
4: 8.9 ←	
5: *10.8 ↗	
Total 426.0	

Relay 4	Lane 14	Filip Jansson	
-------------------	-------------------	----------------------	--

300m	Söderala	U	Gä
------	----------	---	----

2013-07-08	Tavelträffen B 2013	Ramselefors SKF
------------	---------------------	-----------------

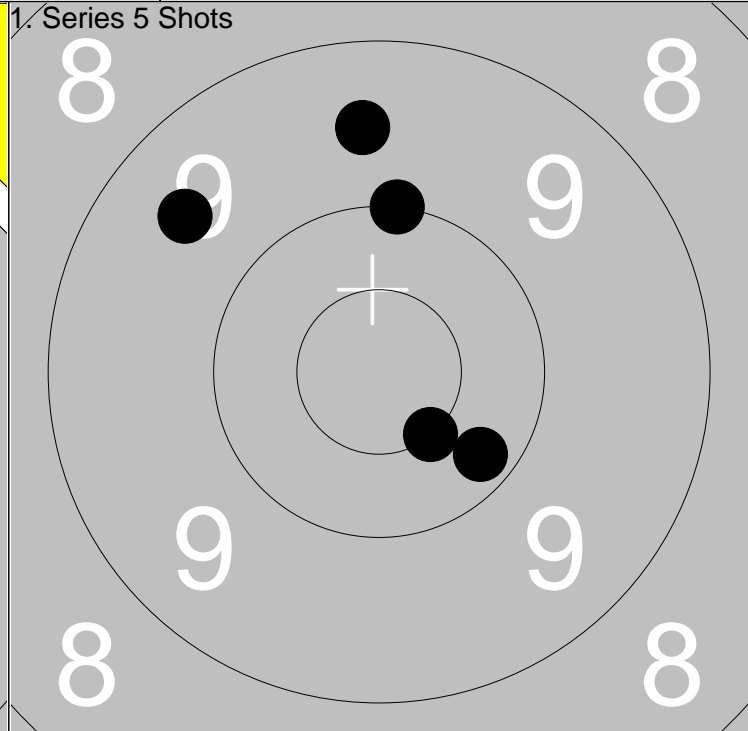
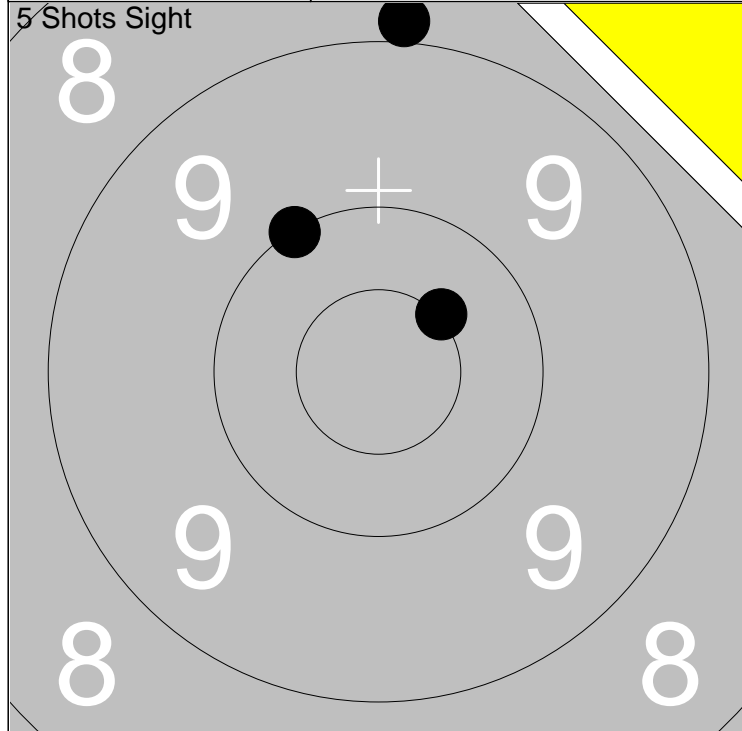

1: 10.0 ↖	Series	28.0
2: 8.9 ↑		
3: *10.5 ↗		
Total		282.0

1: 10.0 ↑	Series	48.0
2: 10.2 ↘		
3: 9.5 ↑		
4: 9.5 ↖		
5: *10.5 ↘		
Total		330.0

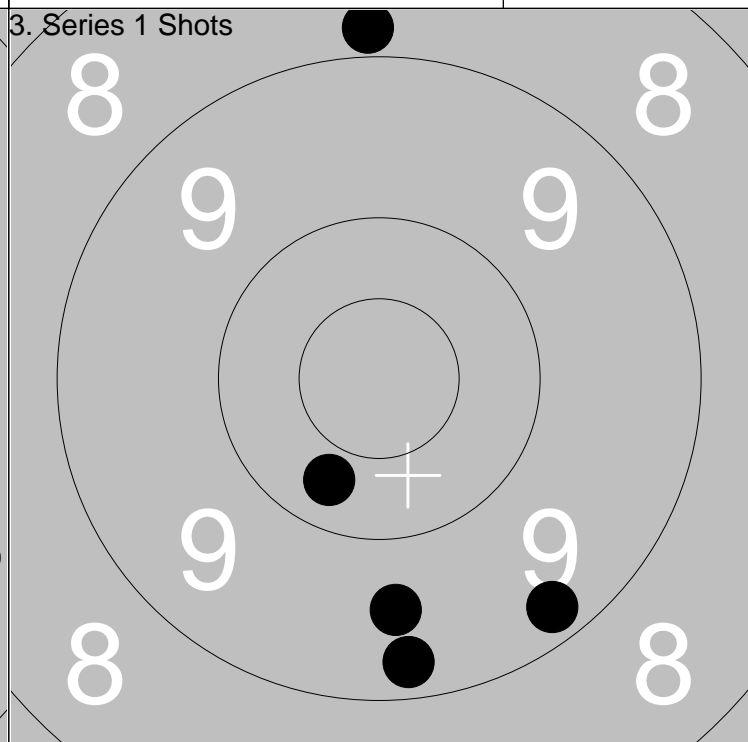
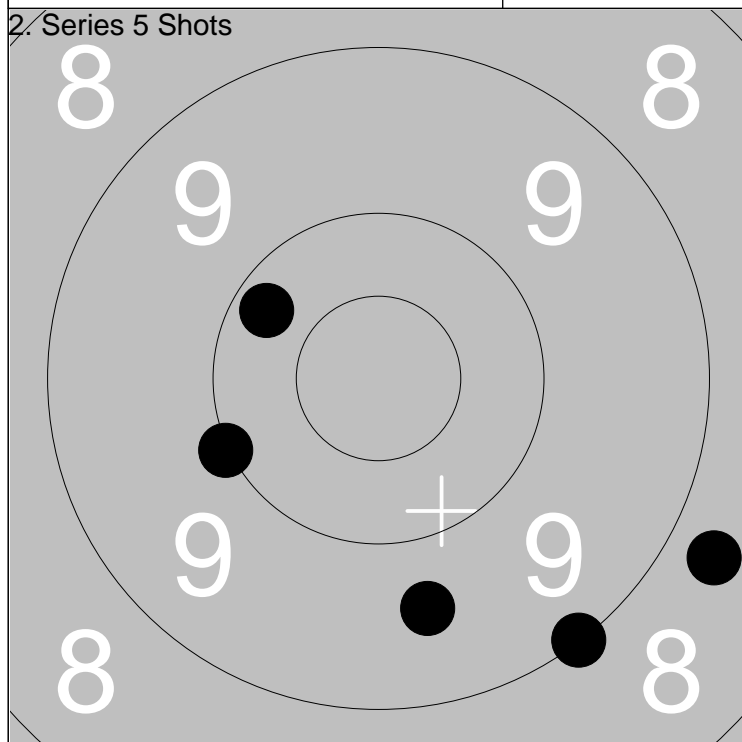

1: 8.7 ↘	Series	46.0
2: 9.0 ↘		
3: 10.2 ↖		
4: 10.0 ↖		
5: 9.6 ↓		
Total		376.0

1: 10.3 ↘	Series	45.0
2: 9.3 ↓		
3: 9.2 ↘		
4: 8.8 ↑		
5: 9.6 ↓		
Total		421.0

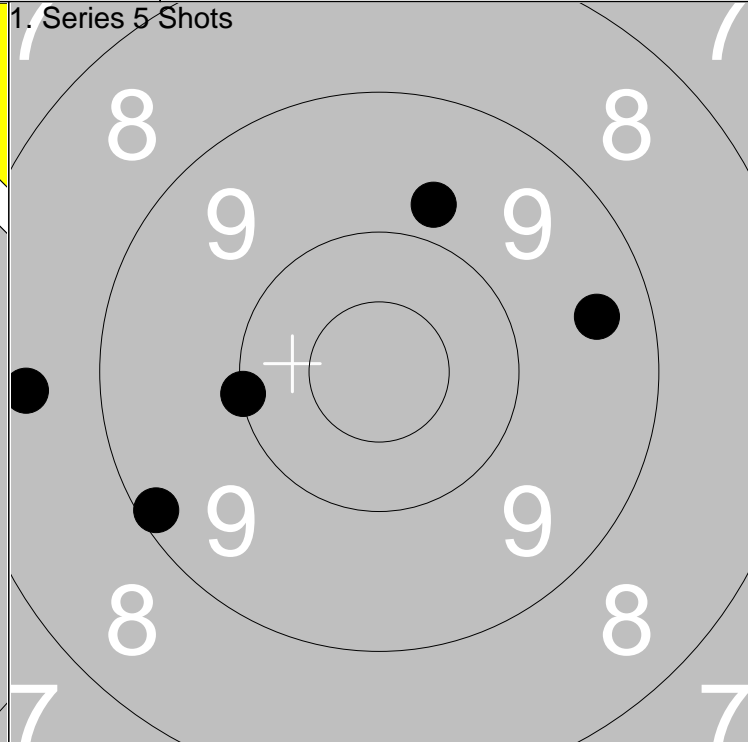
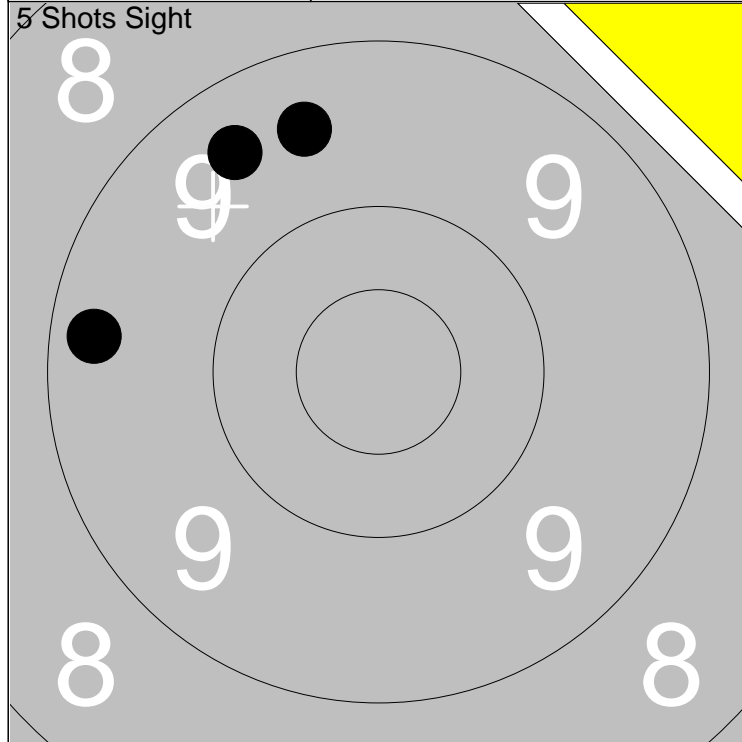

1: 9.4 ↗	Series	27.0
2: 9.3 ←		
3: 9.5 ↗		
Total		250.0

1: 10.0 ←	Series	45.0
2: 8.5 ←		
3: 9.4 →		
4: 9.8 ↗		
5: 9.2 ↙		
Total		295.0

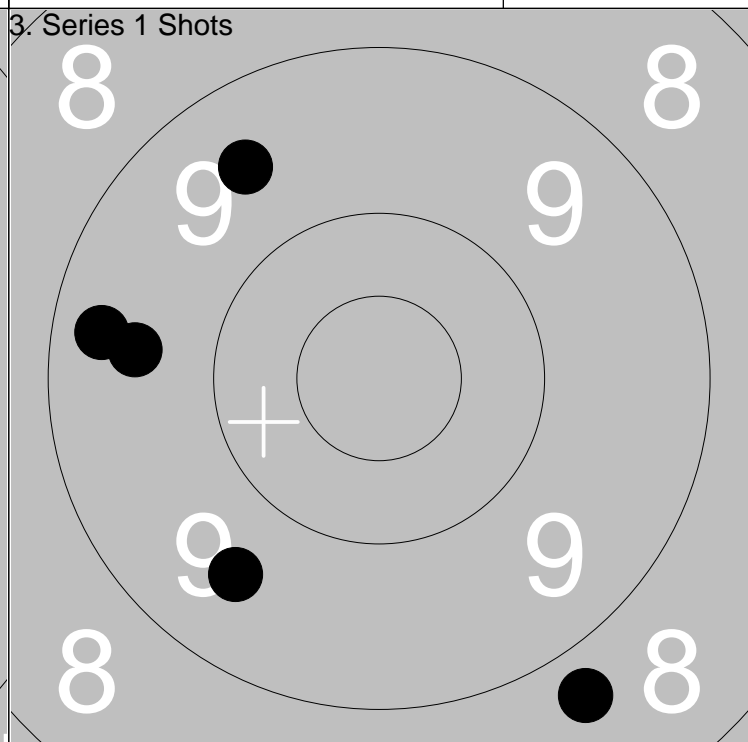
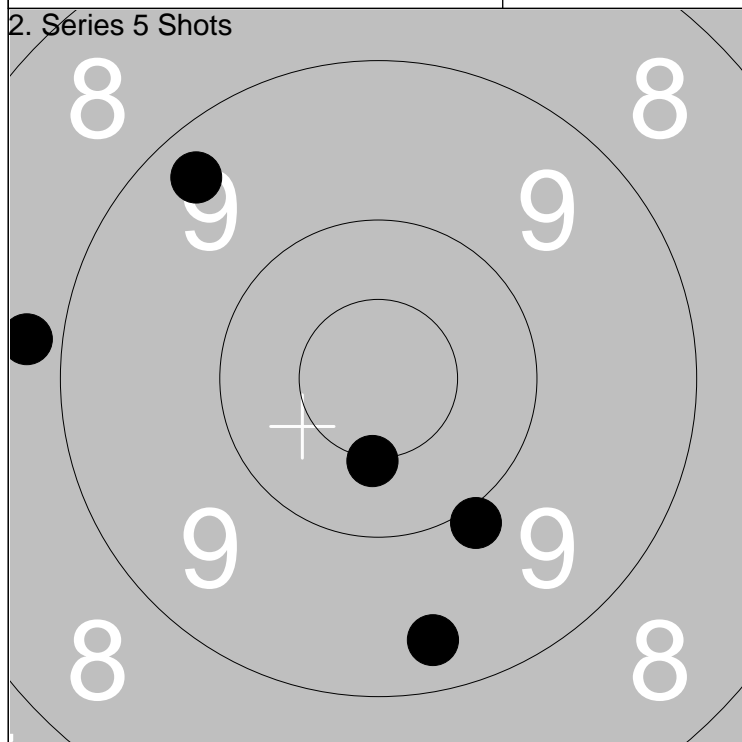

1: 8.8 ←	Series	45.0
2: *10.5 ↓		
3: 9.3 ↓		
4: 9.9 ↘		
5: 9.3 ↗		
Total		340.0

1: 9.3 ←	Series	44.0
2: 9.6 ↘		
3: 8.7 ↘		
4: 9.5 ↗		
5: 9.5 ←		
Total		384.0

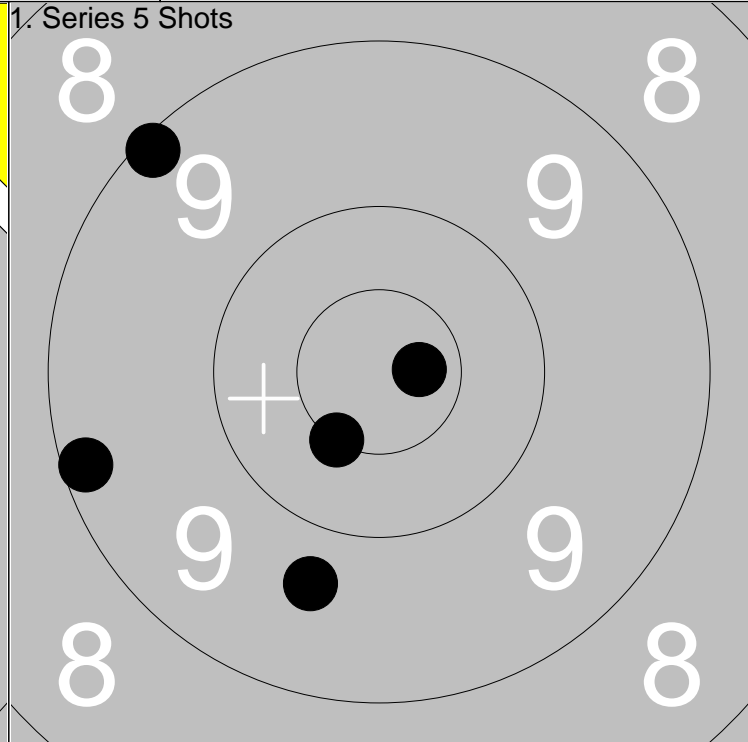
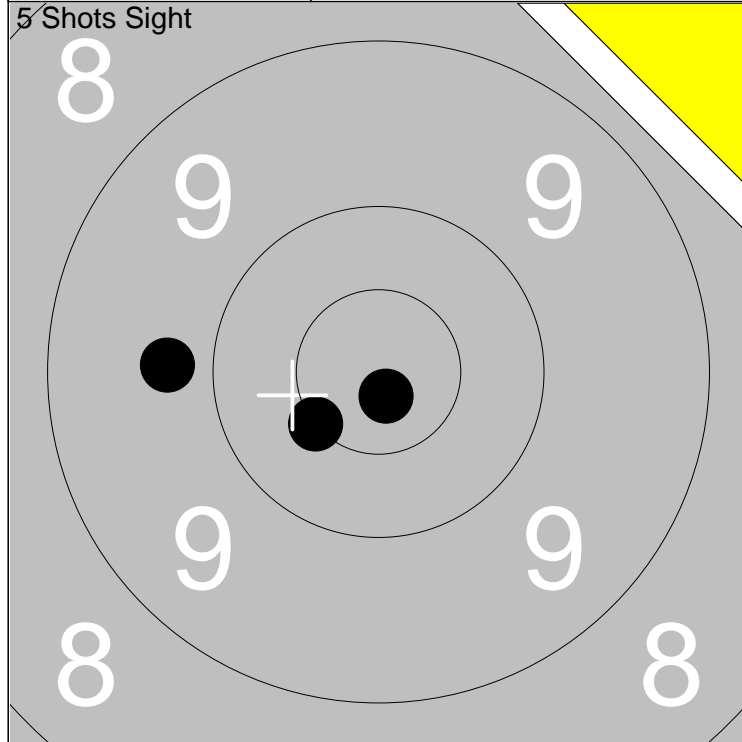

1: *10.5 ↙	Series 29.0
2: 9.8 ←	
3: *10.8 ↓	
Total 133.0	

1: 9.2 ←	Series 47.0
2: 9.1 ↖	
3: *10.7 →	
Total 180.0	

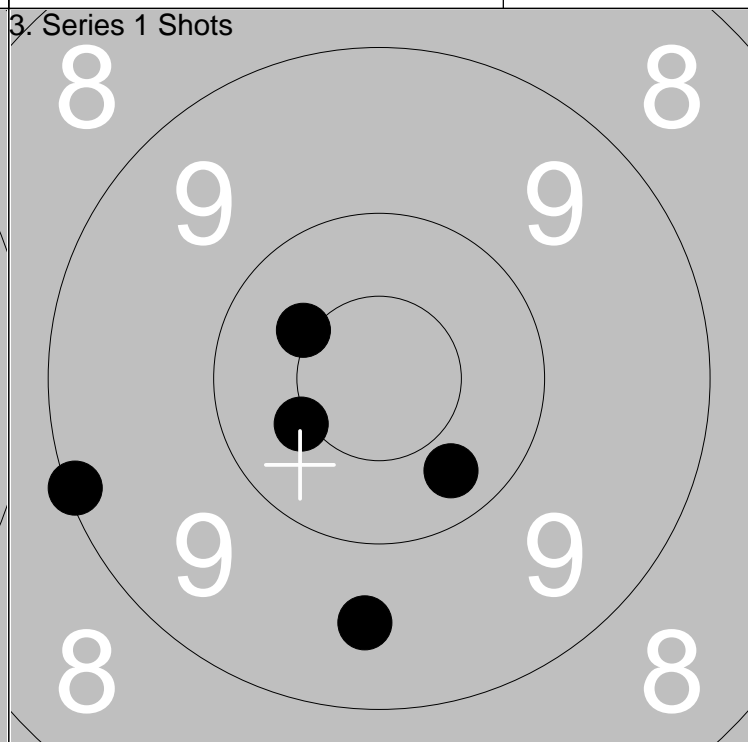
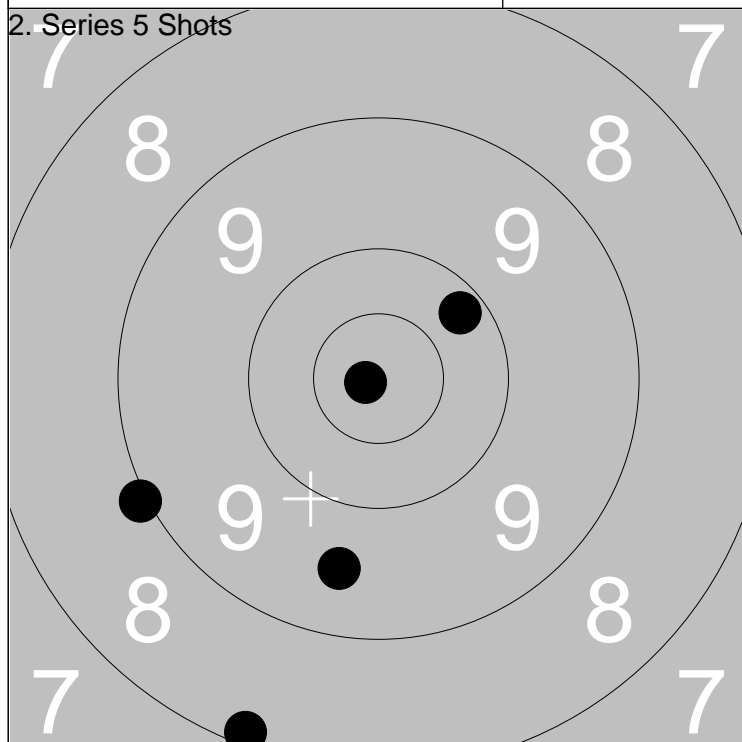

1: 9.5 ↓	Series 46.0
2: *10.9 ↙	
3: 8.1 ↓	
Total 226.0	

1: 9.1 ←	Series 48.0
2: *10.4 ↙	
3: 9.6 ↓	
Total 274.0	

<p>5 Shots Sight</p>	<p>1. Series 5 Shots</p>	<p>1: *10.5↓ 2: 9.9 ↘ 3: 10.4 ↓</p> <p>1: *10.6↓ 2: 9.9 ↑ 3: 9.1 ↘ 4: 10.2↖ 5: 10.0←</p>
Series 29.0	Series 48.0	
Total 286.0	Total 334.0	

<p>2. Series 5 Shots</p>	<p>3. Series 1 Shots</p>	<p>1: 9.9 ← 2: 9.4 → 3: 8.9 → 4: 9.7 ↗ 5: *10.6↓</p> <p>1: 10.1 ↑ 2: 9.6 → 3: 9.5 ↓ 4: 10.3↗ 5: *10.6↗</p>
Series 45.0	Series 48.0	
Total 379.0	Total 427.0	

<p>1. Series 1 Shots Sh.off</p>	<p>2. Series 1 Shots Sh.off</p>	<p>1: *10.5←</p> <p>1: *10.5↖</p>
Series 10.0	Series 10.0	
Total 427.0	Total 427.0	

<p>5 Shots Sight</p>	<p>1: *10.5 ↘ 2: 10.2 → 3: 9.9 ←</p>	<p>1. Series 5 Shots</p>		<p>1: 8.5 ↖ 2: 9.4 ↖ 3: 9.9 → 4: 9.4 ↖ 5: 10.2 ↘</p>	
Series 29.0				Series 45.0	
Total 285.0				Total 330.0	

<p>2. Series 5 Shots</p>	<p>1: 10.3 ↖ 2: 10.1 ↖ 3: 10.0 → 4: *10.7 ↖ 5: 9.8 ↗</p>	<p>3. Series 1 Shots</p>		<p>1: 10.1 ↗ 2: 9.0 → 3: 10.0 ↘ 4: 10.1 ↖ 5: 9.7 →</p>	
Series 49.0				Series 48.0	
Total 379.0				Total 427.0	

<p>1. Series 1 Shots Sh.off</p>	<p>1: *10.5 ↘</p>	<p>2. Series 1 Shots Sh.off</p>		<p>1: 9.6 ↖</p>	
Series 10.0				Series 9.0	
Total 427.0				Total 427.0	

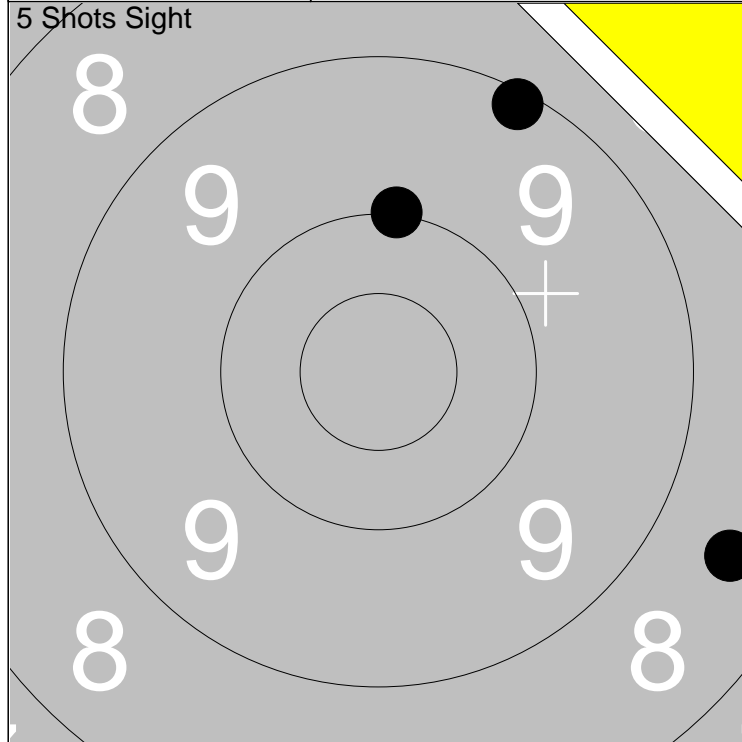

1: 9.1 ↗	Series	27.0
2: 10.0 ↑		
3: 8.5 →		
Total		283.0

1: 10.1 ↗	Series	47.0
2: 9.6 →		
3: 9.7 →		
Total		330.0

4: 10.1 ↖	Series	44.0
5: 9.5 ←		
Total		

1: 9.8 ↗	Series	46.0
2: 10.0 ↖		
3: 8.9 ←		
Total		376.0

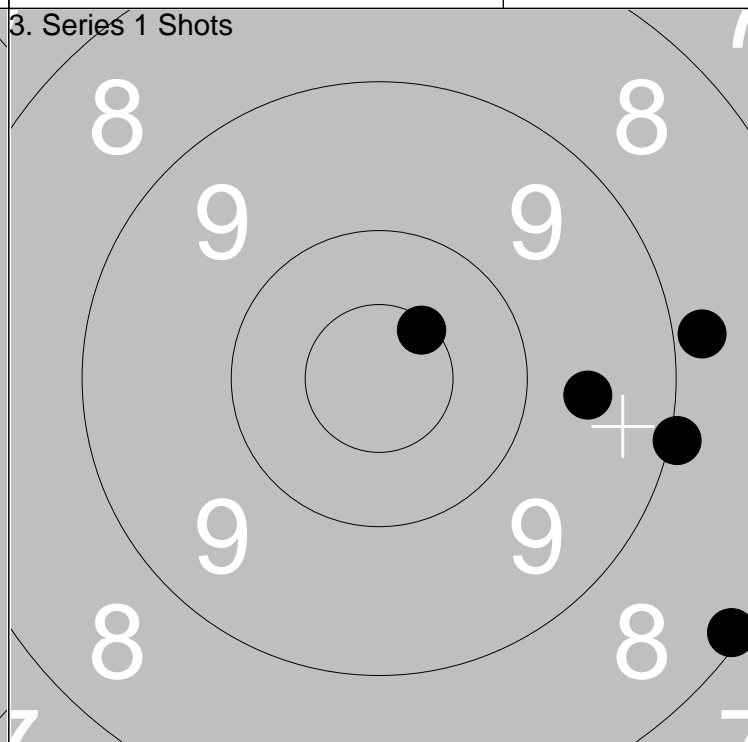
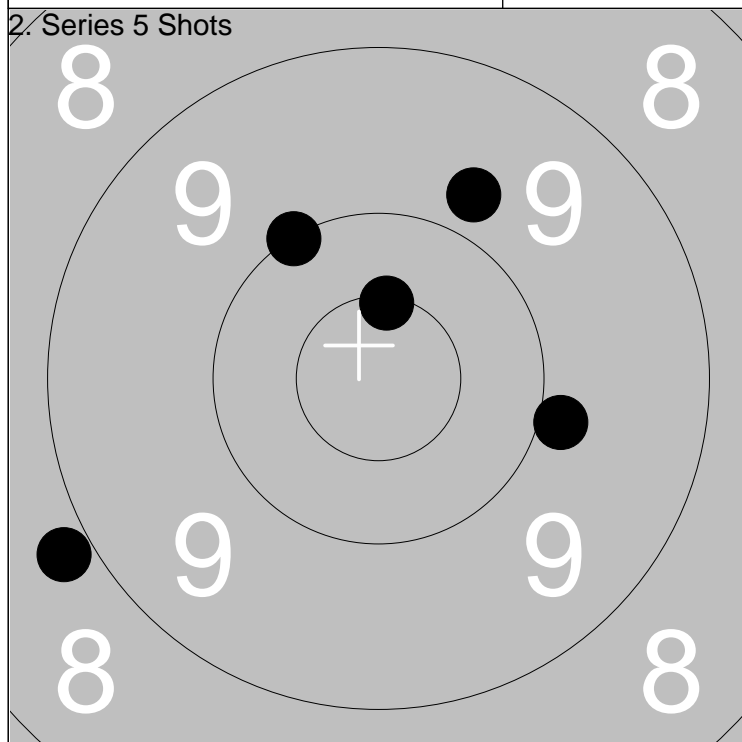

4: *10.5 ↑	Series	44.0
5: 9.9 →		
Total		

1: 9.6 →	Series	44.0
2: 8.8 →		
3: 8.1 ↘		
Total		420.0

4: *10.6 ↗	Series	44.0
5: 9.0 →		
Total		

1: 9.6 →	Series	44.0
2: 8.8 →		
3: 8.1 ↘		
Total		420.0

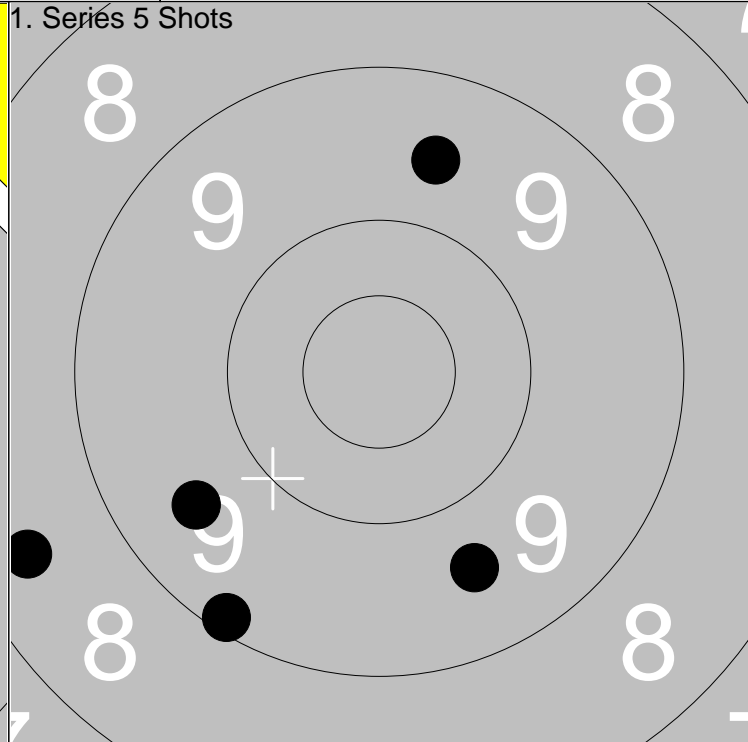
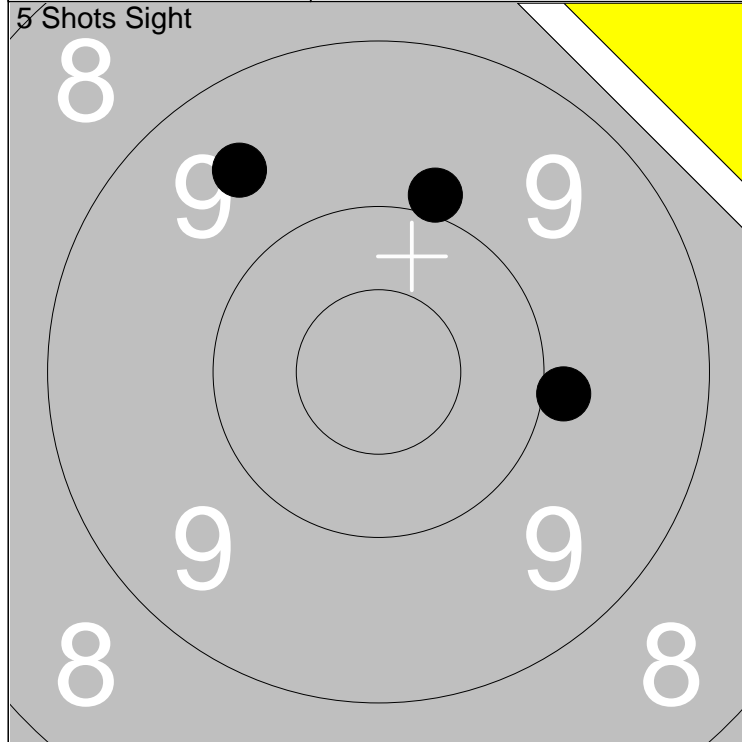

1: 9.6 ↖	Series	27.0
2: 9.9 ↑		
3: 9.9 →		
Total		280.0

1: 9.1 ↙	Series	44.0
2: 9.6 ↑		
3: 9.5 ↙		
4: 8.4 ↙		
5: 9.6 ↘		
Total		324.0

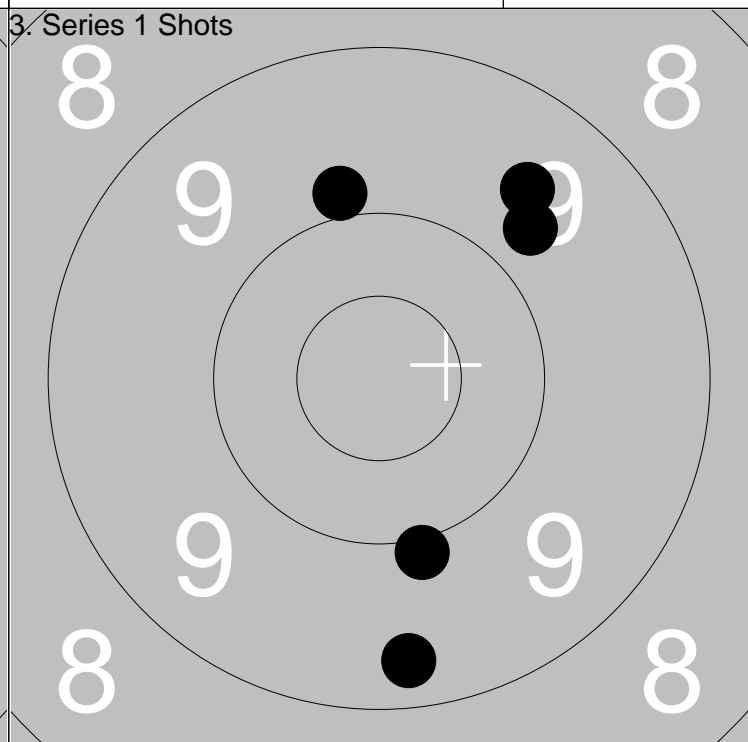
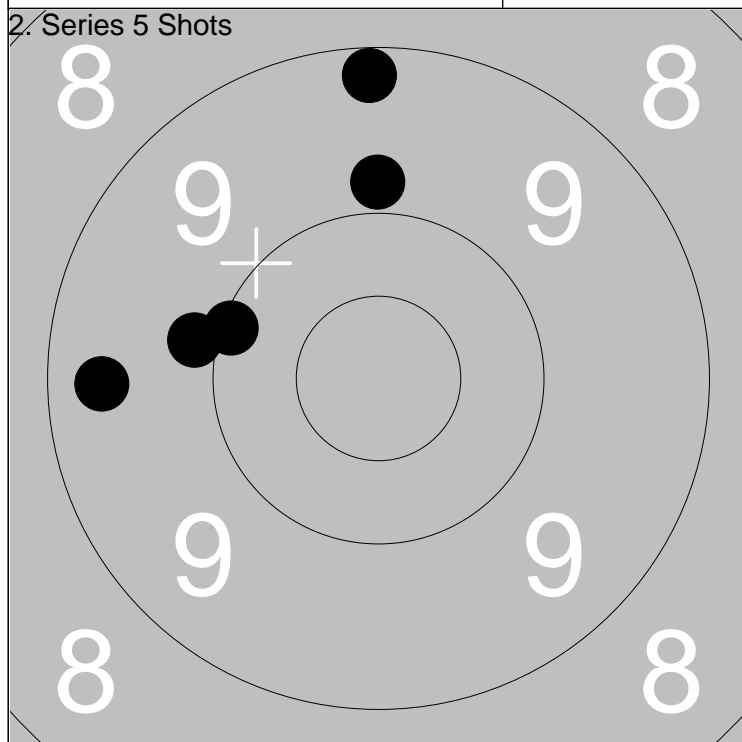

1: 10.1 ←	Series	46.0
2: 9.9 ←		
3: 9.2 ↑		
4: 9.4 ←		
5: 9.8 ↑		
Total		370.0

1: 9.9 ↑	Series	45.0
2: 9.3 ↓		
3: 9.7 ↗		
4: 9.9 ↓		
5: 9.6 ↗		
Total		415.0

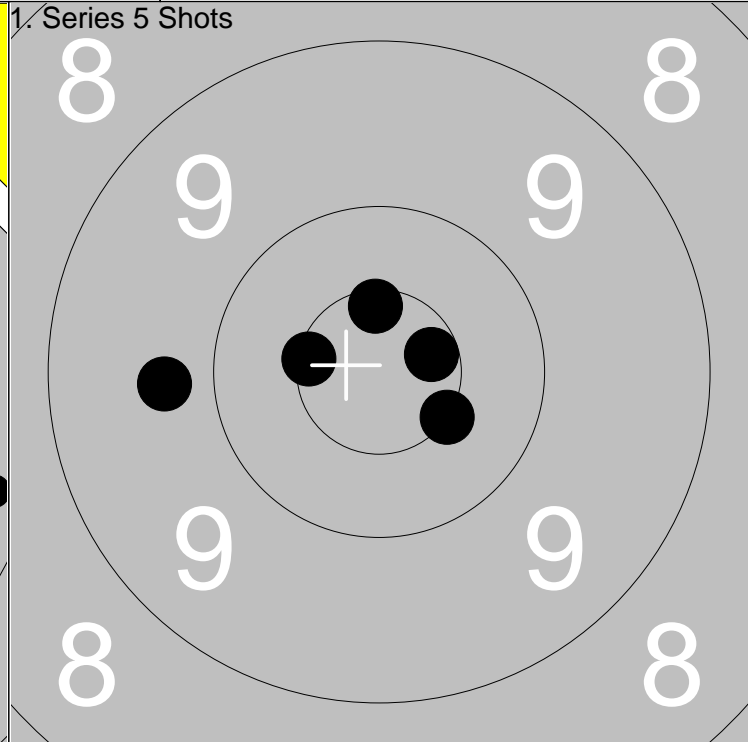
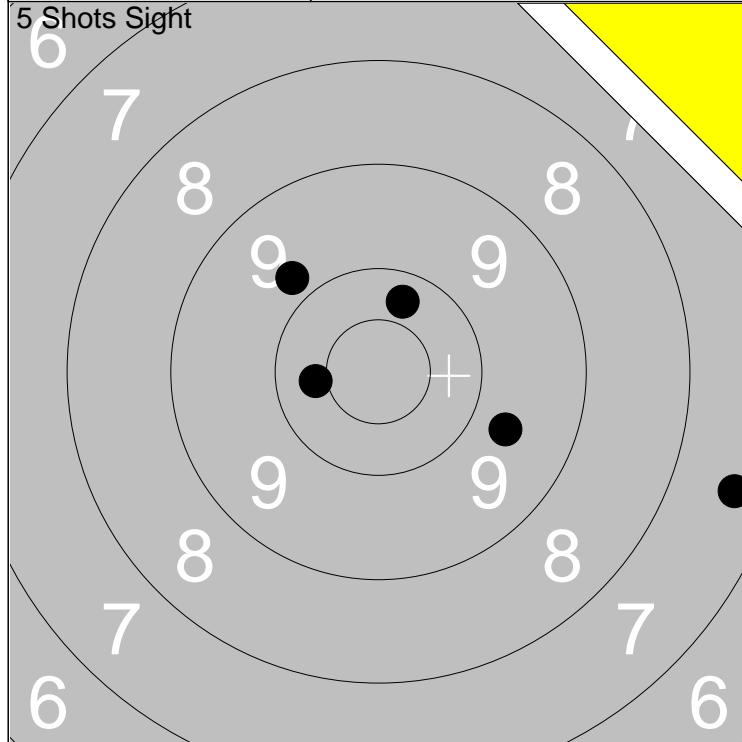

1: 10.3 ↗	Series	45.0
2: 10.4 ↖		
3: 9.8 ↗	Total	283.0
4: 7.4 →		
5: 9.7 ↘		

1: 9.7 ←	Series	49.0
2: *10.6 →		
3: *10.6 ↗	Total	332.0
4: *10.5 ↘		
5: *10.5 ↖		

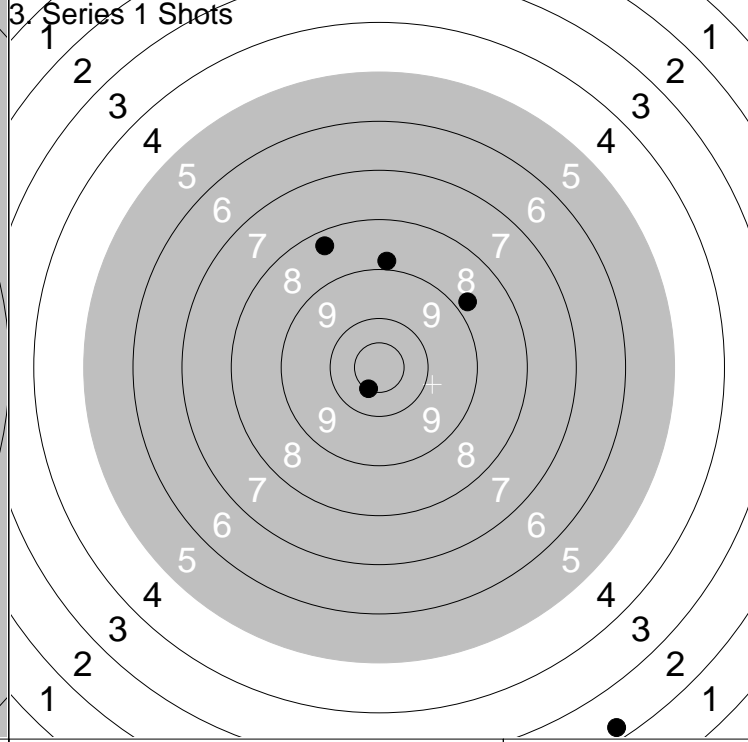
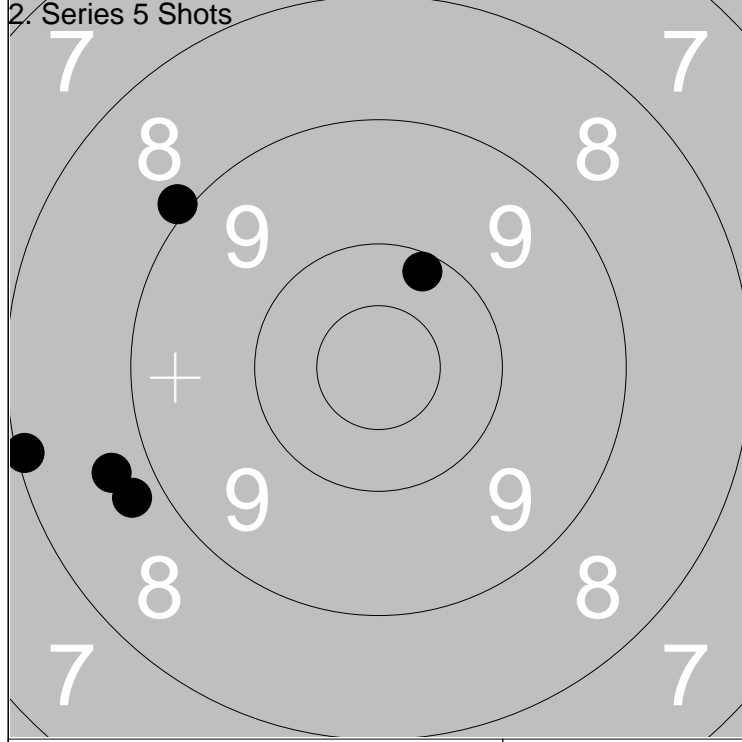

1: 8.7 ←	Series	42.0
2: 8.8 ↖		
3: 10.2 ↗	Total	374.0
4: 8.9 ↖		
5: 8.1 ←		

1: *10.5 ↘	Series	36.0
2: 2.3 ↘		
3: 8.3 ↗	Total	410.0
4: 8.8 ↗		
5: 8.9 ↗		

Relay 5	Lane 2	Markus Andersson		
-------------------	------------------	-------------------------	--	--

300m	Bälinge-Jumkil	B	Up
------	----------------	---	----

2013-07-08	Tavelträffen B 2013	Ramselefors SKF
------------	---------------------	-----------------

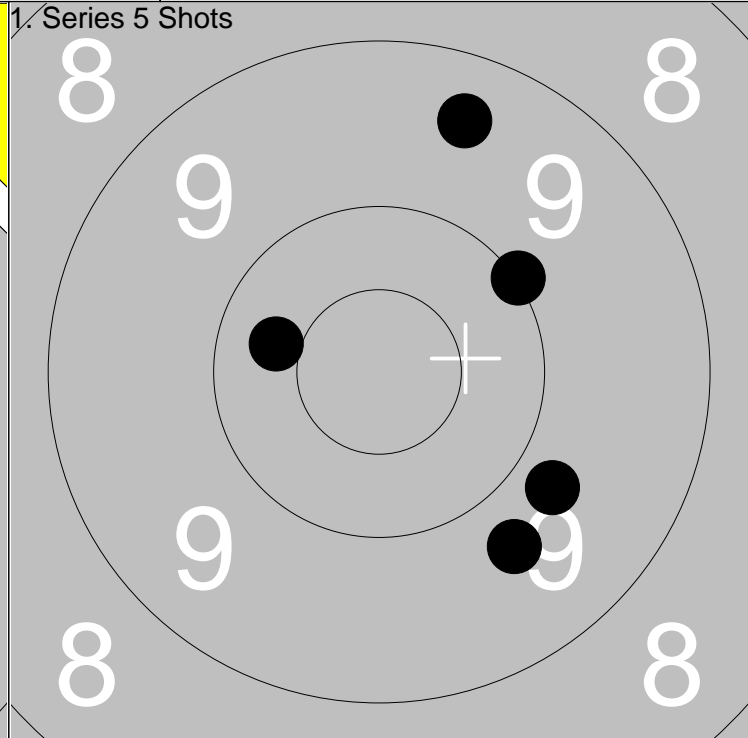
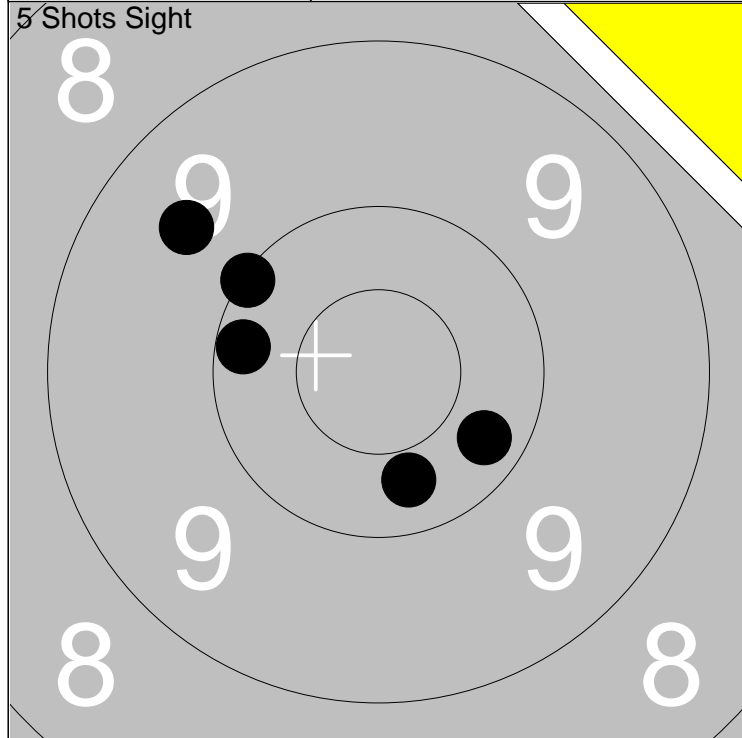

1: 10.3 ↘	Series	49.0
2: 10.2 ←		
3: 10.3 ↓	Total	275.0
4: 9.6 ↗		
5: 10.1 ↖		

1: 9.7 ↘	Series	47.0
2: 9.4 ↑		
3: 10.4 ←	Total	322.0
4: 9.8 ↘		
5: 10.0 ↗		

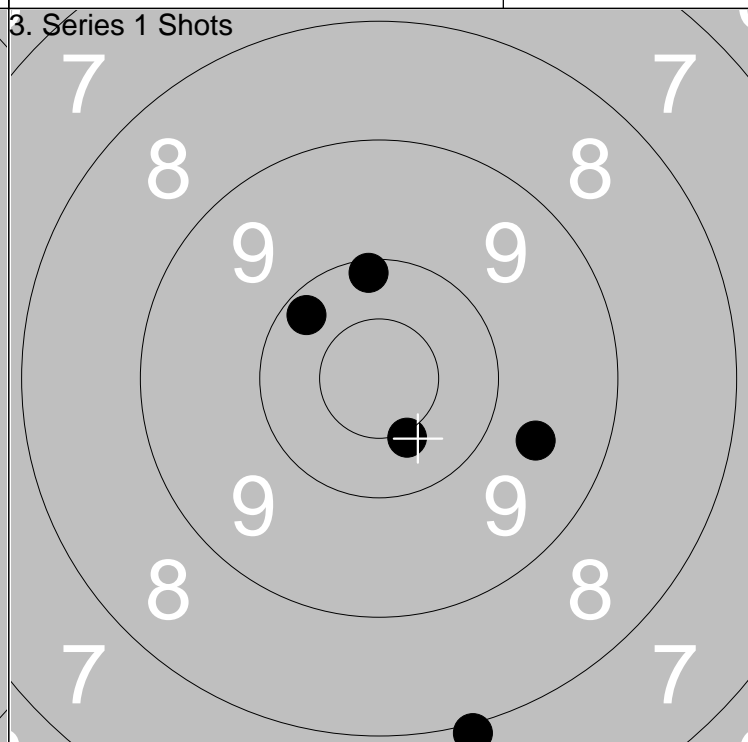
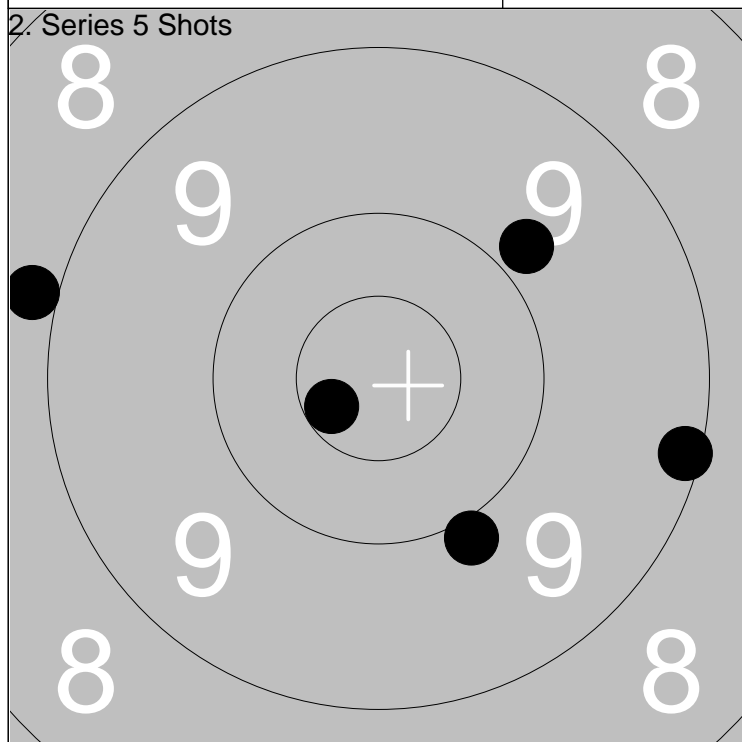

1: 9.8 ↗	Series	45.0
2: 9.1 →		
3: *10.6 ↙	Total	367.0
4: 8.9 ←		
5: 9.9 ↓		

1: *10.4 ↓	Series	47.0
2: 10.2 ↖		
3: 8.0 ↓	Total	414.0
4: 10.1 ↑		
5: 9.6 ↘		

Relay 5	Lane 3	Sara Borg		
-------------------	------------------	------------------	--	--

300m	Ununge	B	St
------	--------	---	----

2013-07-08	Tavelträffen B 2013	Ramselefors SKF	
------------	---------------------	-----------------	--

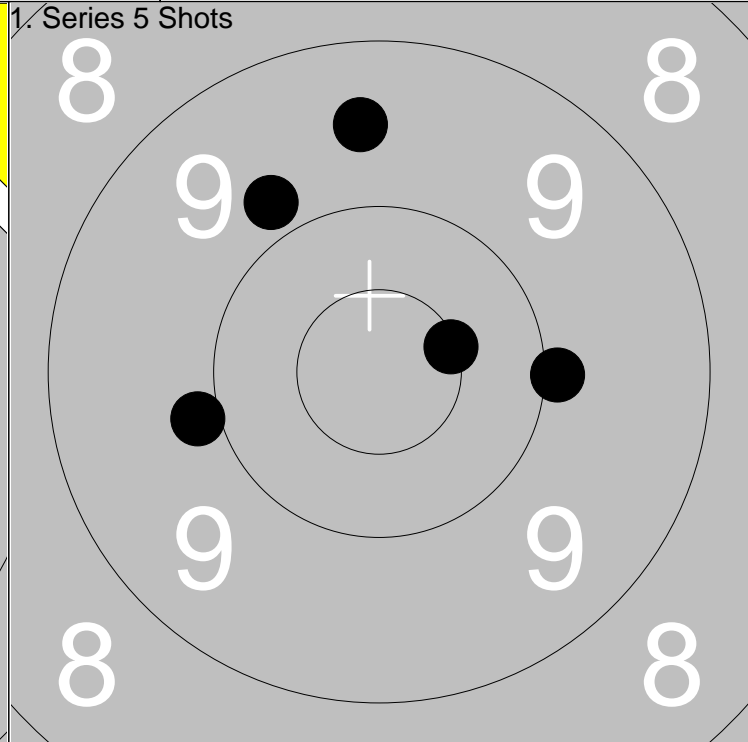
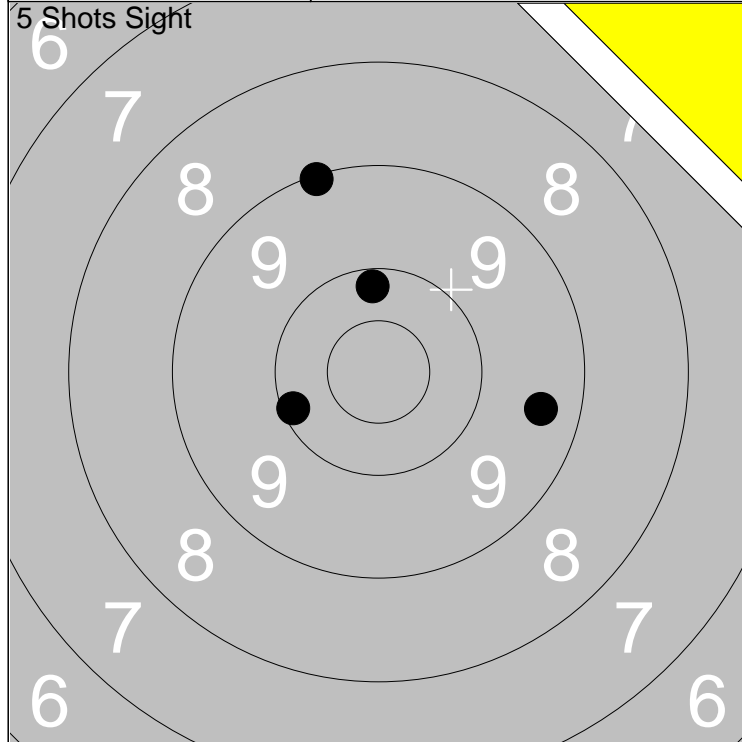

1: 9.4 →
2: 10.2 ↑
3: 9.1 ↑
4: 10.1 ←
5: 7.0 ↗

Series	45.0
Total	275.0

1: 9.9 ←
2: 9.9 →
3: 9.8 ↖
4: 9.5 ↑
5: *10.5 →

Series	46.0
Total	321.0

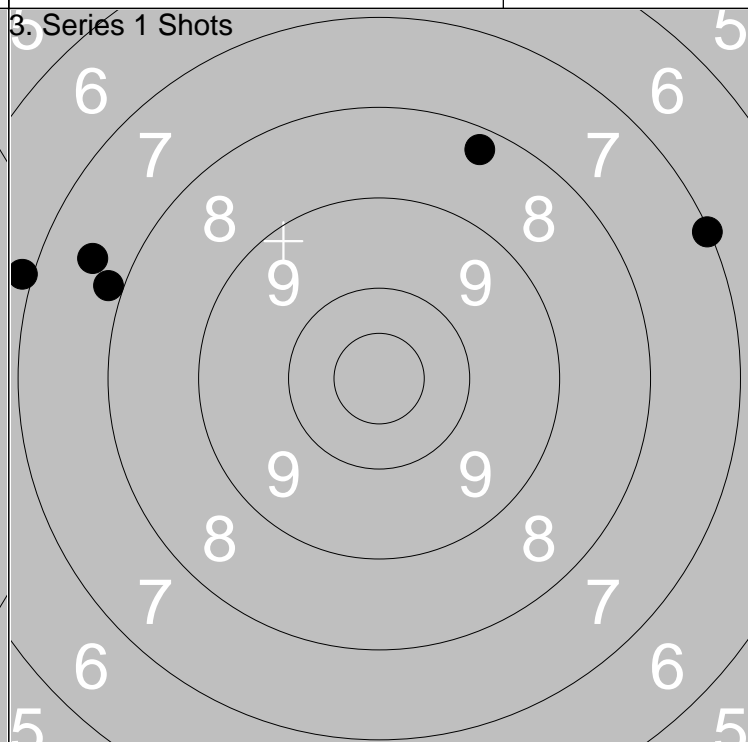
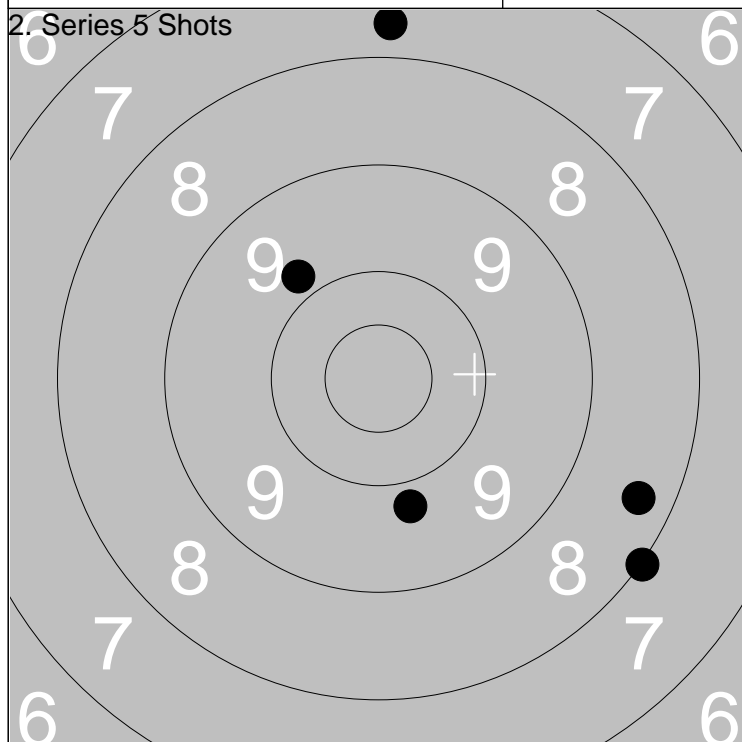

1: 8.0 ↘
2: 8.4 →
3: 9.8 ↓
4: 7.7 ↑
5: 9.8 ↖

Series	41.0
Total	362.0

1: 7.6 ←
2: 7.9 ←
3: 6.9 ←
4: 7.1 ↗
5: 8.3 ↑

Series	35.0
Total	397.0

Relay 5	Lane 4	Jan Wallerström	
-------------------	------------------	------------------------	--

300m	Ununge	B	St
------	--------	---	----

2013-07-08	Tavelträffen B 2013	Ramselefors SKF
------------	---------------------	-----------------

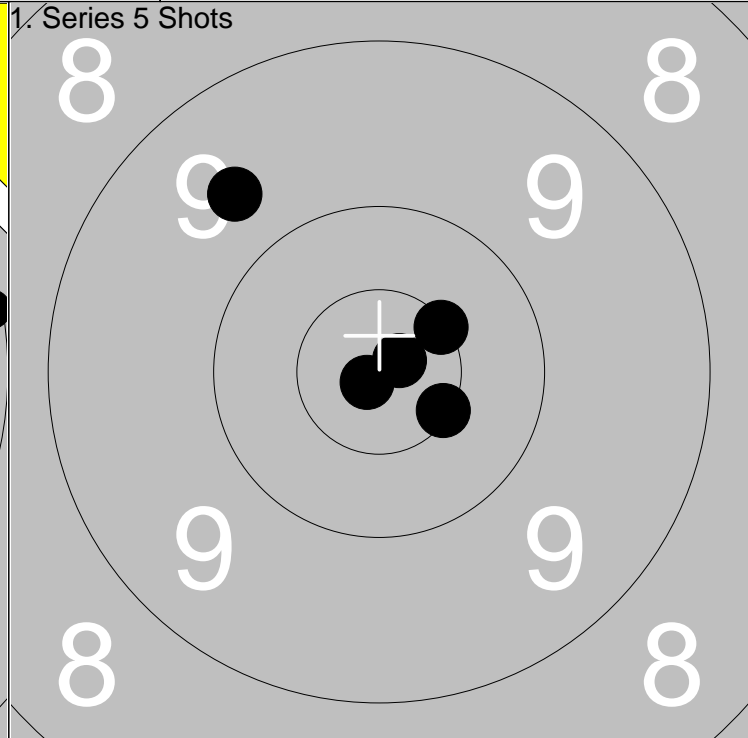
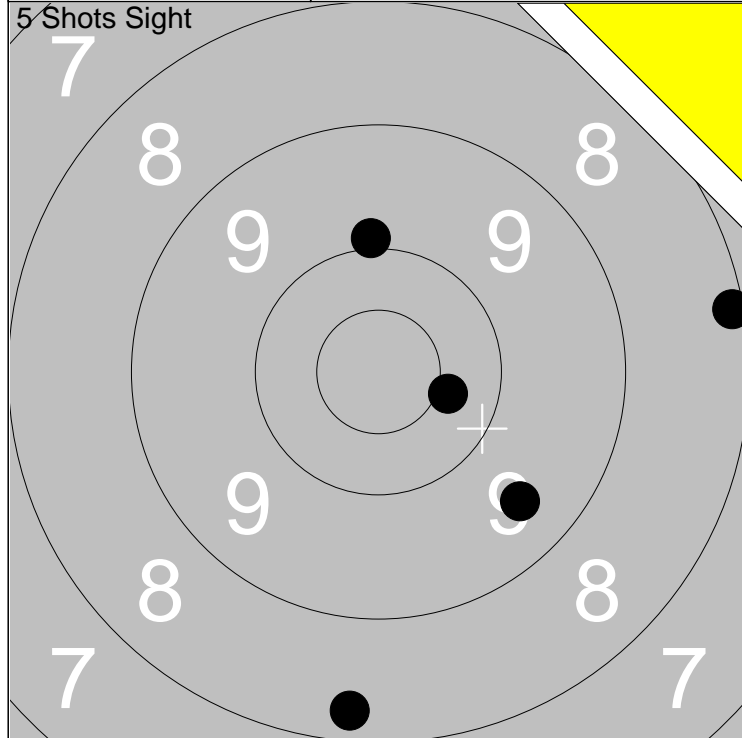

1: 9.5 ↘
2: 9.9 ↑
3: 8.3 ↓
4: 8.1 →
5: 10.4 ↘

Series	44.0
Total	274.0

1: *10.5 ↘
2: *10.9 ↘
3: *10.8 ↗
4: 9.6 ↖
5: *10.5 ↗

Series	49.0
Total	323.0

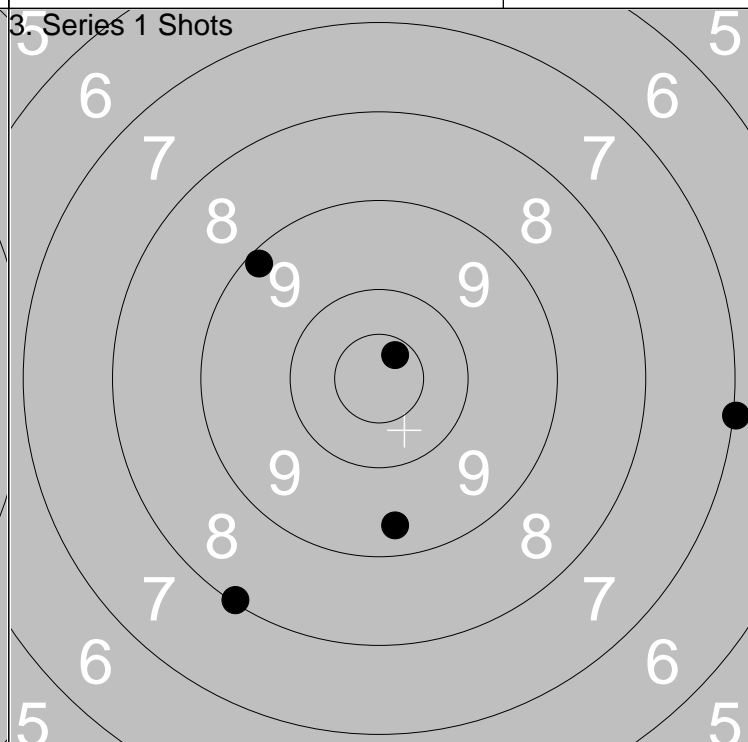
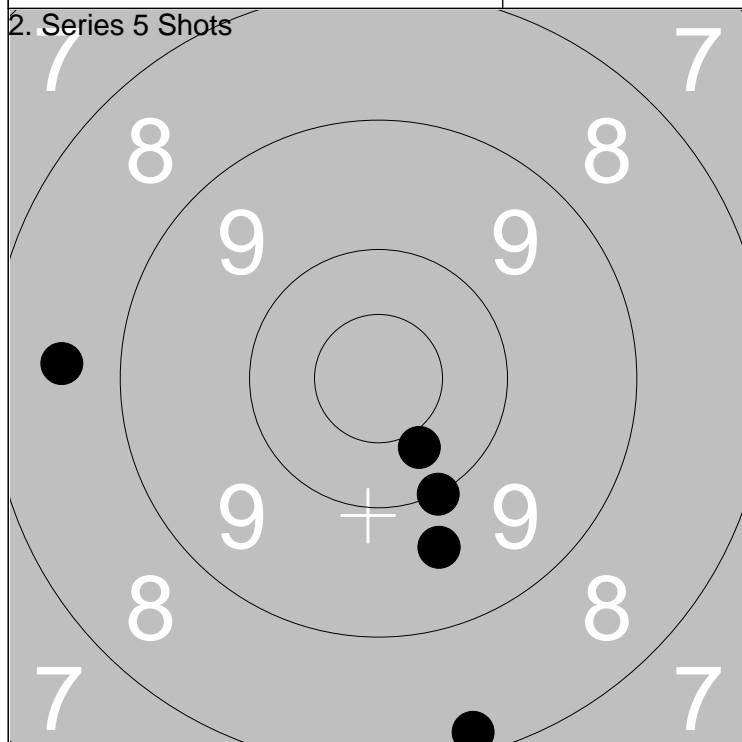

1: 9.6 ↓
2: 8.2 ↓
3: 8.6 ←
4: 10.0 ↓
5: 10.4 ↓

Series	45.0
Total	368.0

1: 9.4 ↓
2: 7.0 →
3: 8.1 ↓
4: *10.7 ↗
5: 9.2 ↖

Series	43.0
Total	411.0

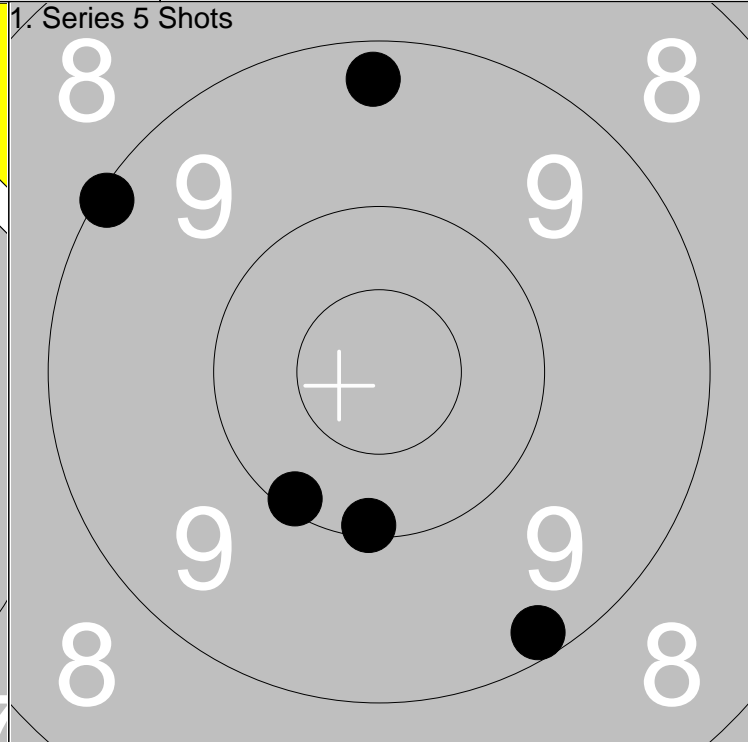
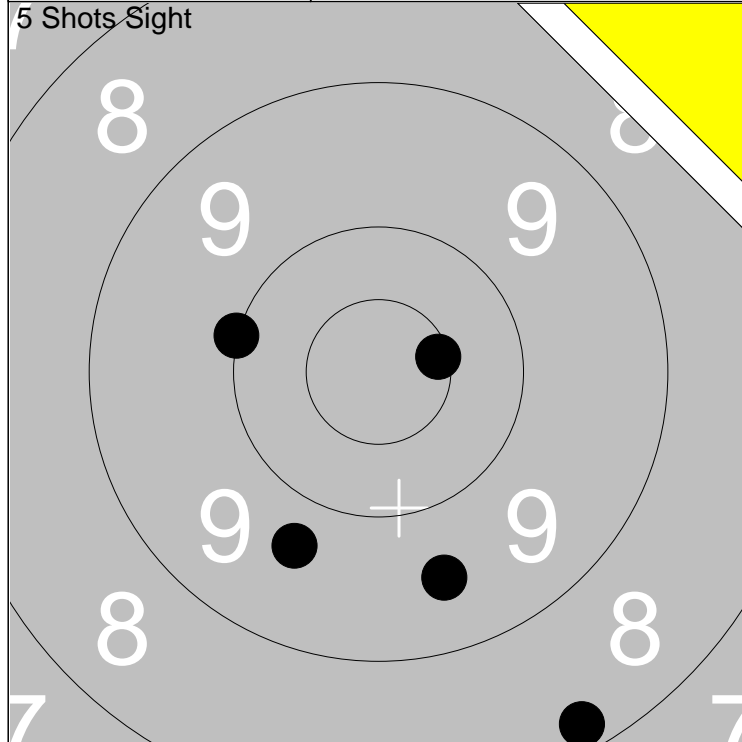

1: *10.6 →	Series 46.0
2: 9.7 ↓	
3: 10.0 ←	Total 274.0
4: 9.5 ↓	
5: 8.2 ↓	

1: 10.1 ↓	Series 47.0
2: 9.3 ↑	
3: 9.1 ↖	Total 321.0
4: 9.2 ↓	
5: 10.1 ↓	

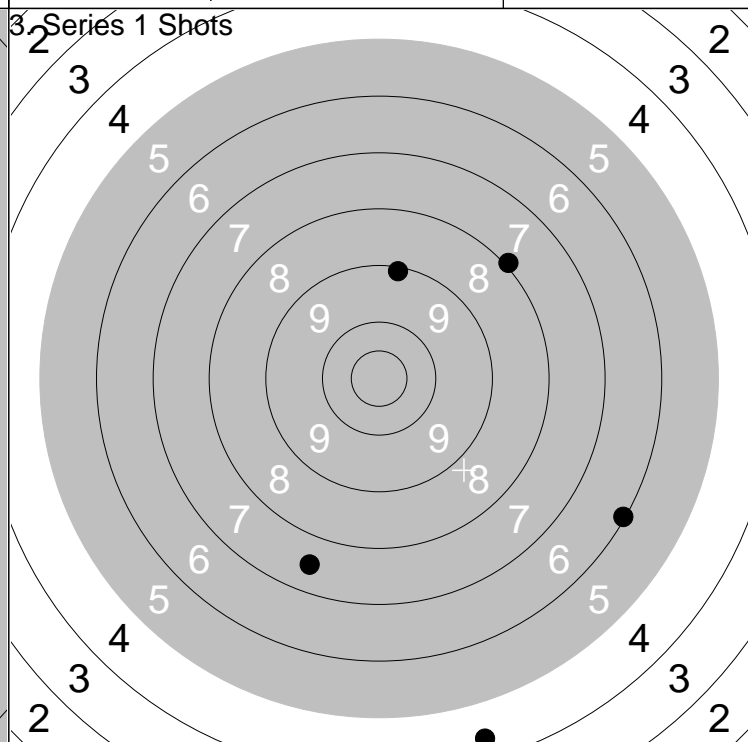
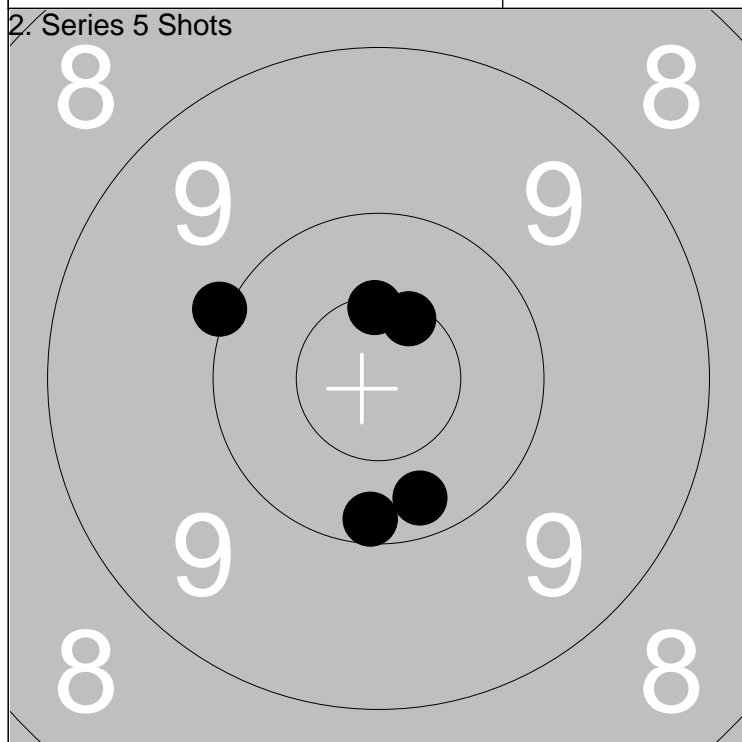

1: 10.0 ↖	Series 50.0
2: 10.2 ↓	
3: *10.6 ↗	Total 371.0
4: 10.2 ↓	
5: *10.6 ↑	

1: 7.5 ↓	Series 34.0
2: 4.4 ↓	
3: 9.1 ↑	Total 405.0
4: 6.1 →	
5: 8.0 ↗	

Relay **5** Lane **6** **Linda Bergman**

300m Ununge B St

2013-07-08 Tavelträffen B 2013 Ramselefors SKF

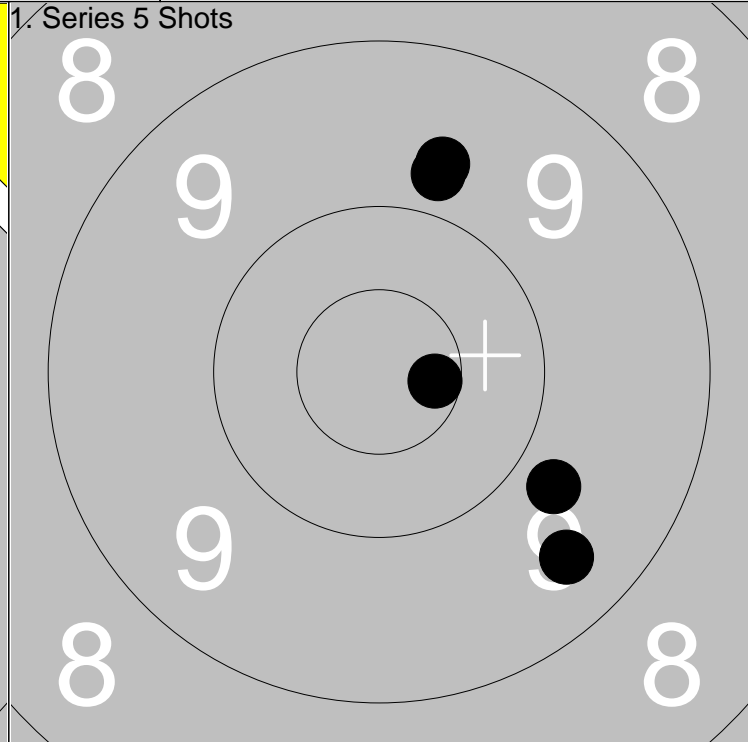
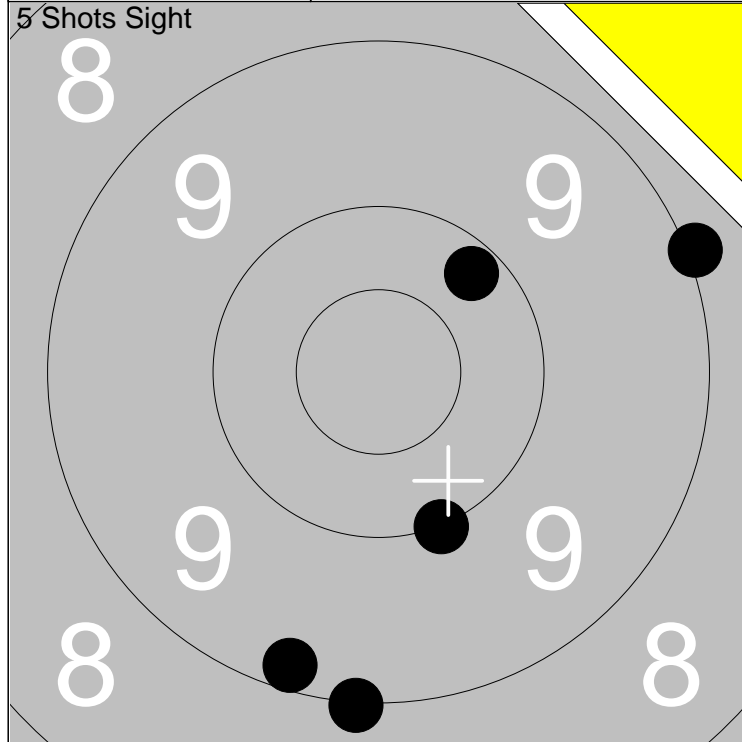

1: 9.0 →	Series 47.0
2: 9.2 ↓	
3: 9.0 ↓	Total 273.0
4: 10.2 ↗	
5: 10.0 ↓	

1: 9.8 ↘	Series 46.0
2: 9.7 ↑	
3: 9.8 ↑	Total 319.0
4: 9.4 ↓	
5: *10.6 →	

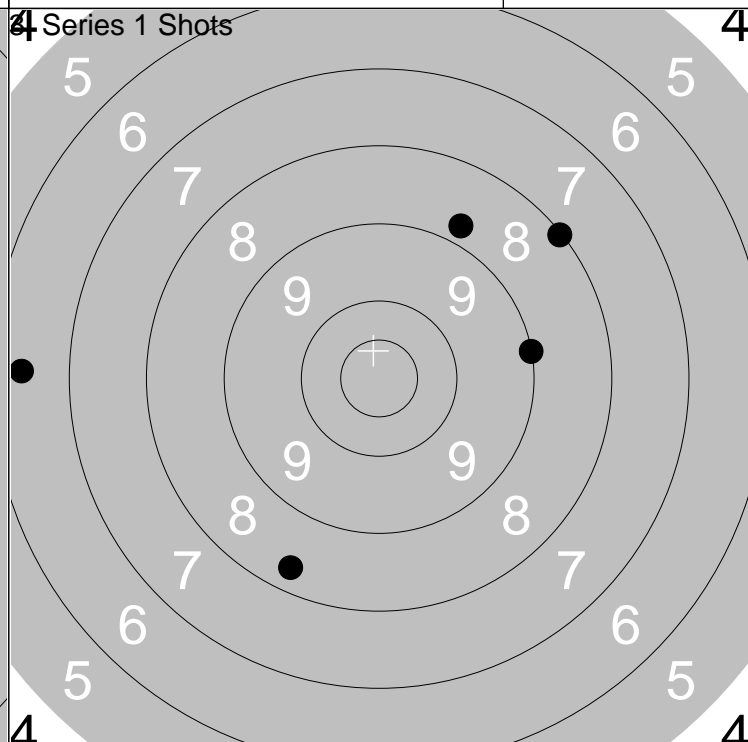
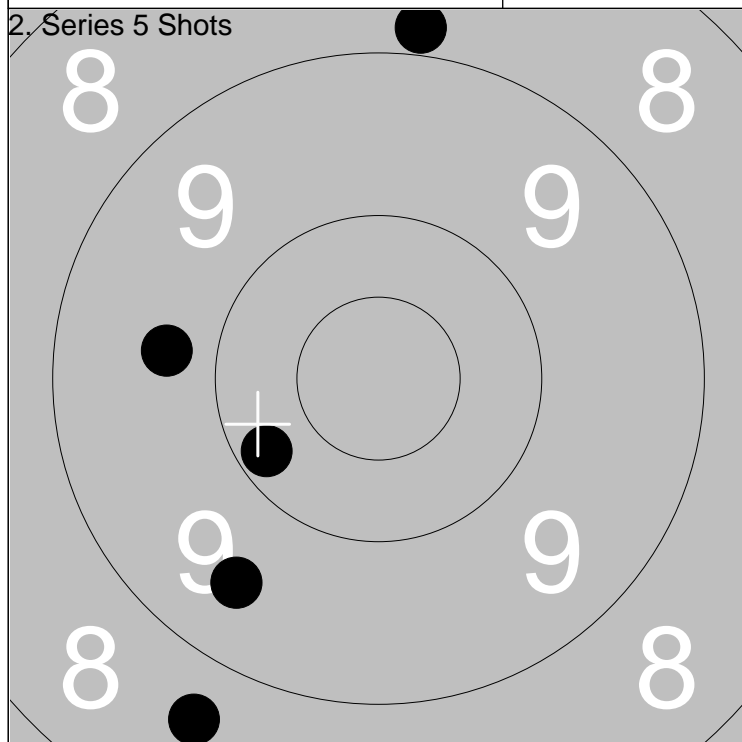

1: 9.5 ↓	Series 44.0
2: 10.2 ↙	
3: 9.7 ←	Total 363.0
4: 8.9 ↑	
5: 8.7 ↓	

1: 8.1 ↗	Series 39.0
2: 8.8 ↑	
3: 9.0 →	Total 402.0
4: 8.3 ↓	
5: 6.4 ←	

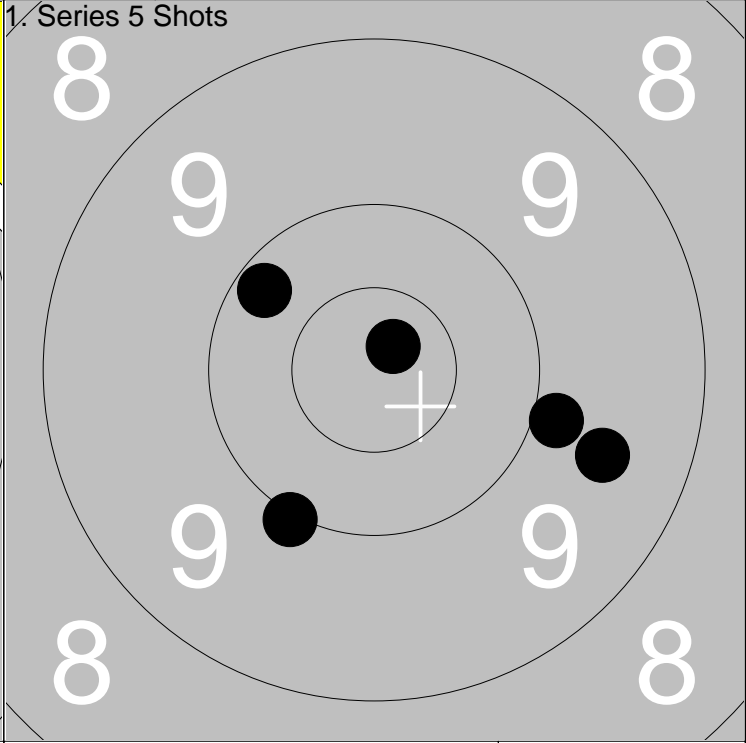
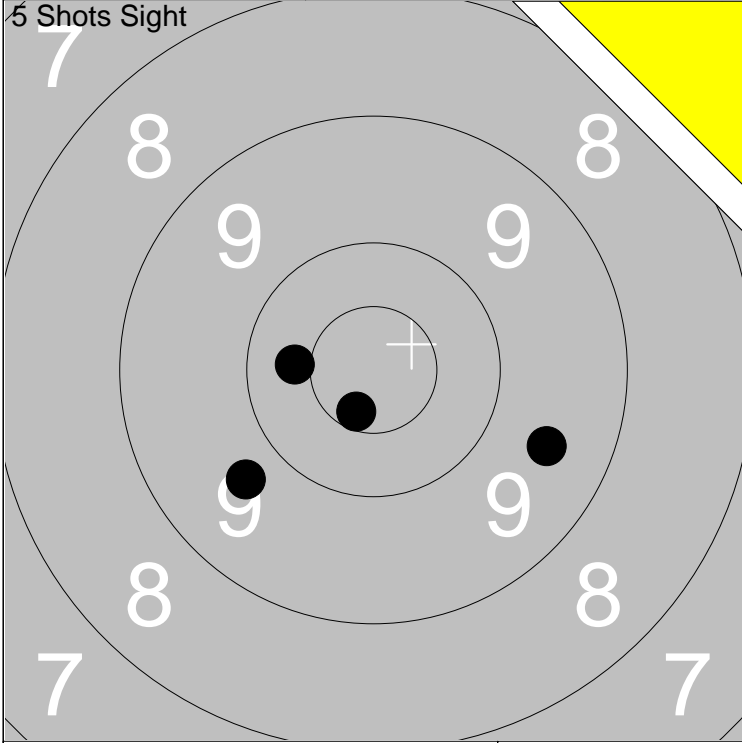

1: 9.7 ↙	Series	45.0
2: *10.6 ↓		
3: 10.4 ←	Total	272.0
4: 7.6 ↗		
5: 9.5 ➔		

1: 10.0 ↓	Series	48.0
2: 9.6 ➔		
3: *10.8 ↗	Total	320.0
4: 10.2 ↖		
5: 9.9 ➔		

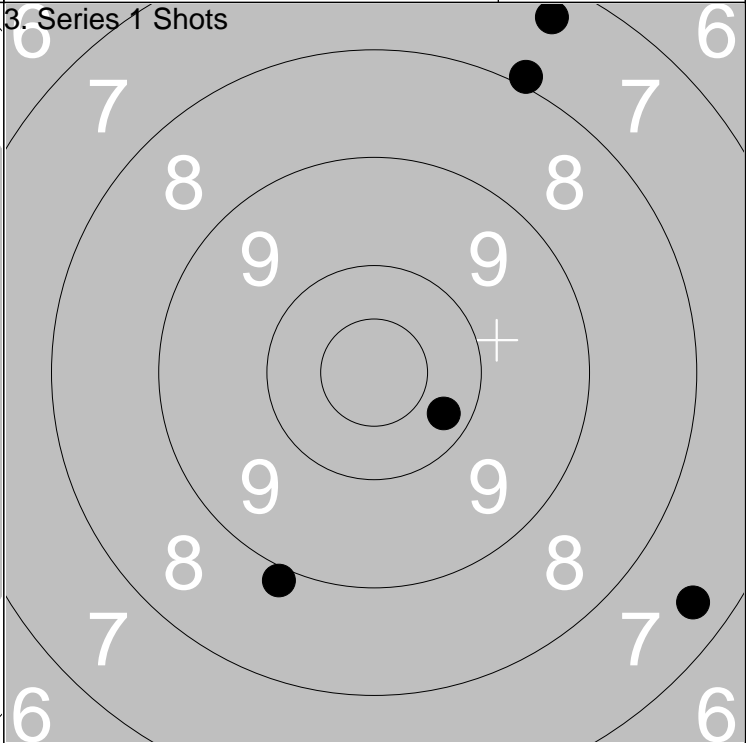
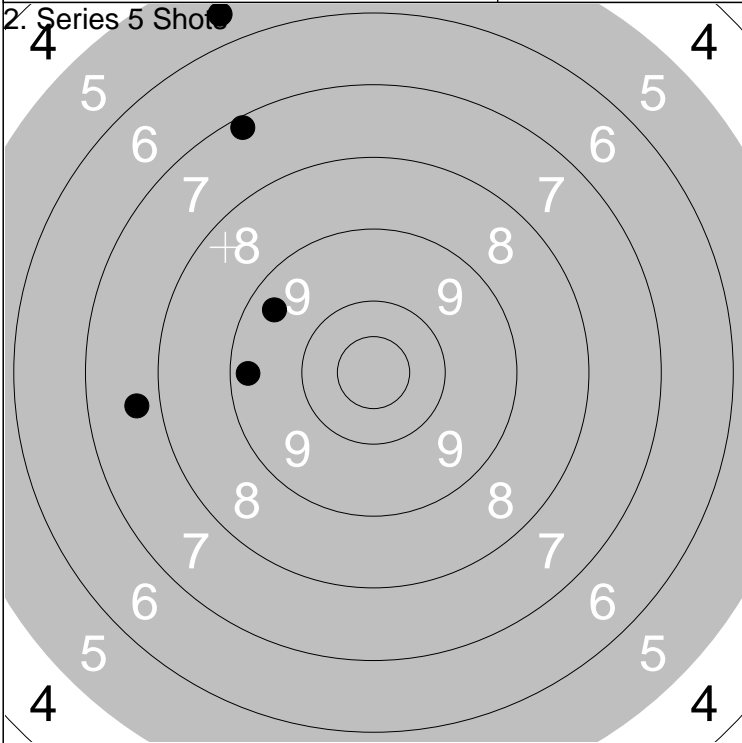

1: 7.2 ↗	Series	37.0
2: 5.6 ↗		
3: 9.4 ↖	Total	357.0
4: 9.3 ←		
5: 7.7 ←		

1: 7.9 ↗	Series	39.0
2: 7.3 ↗		
3: 8.9 ↓	Total	396.0
4: 10.3 ➔		
5: 7.4 ➔		

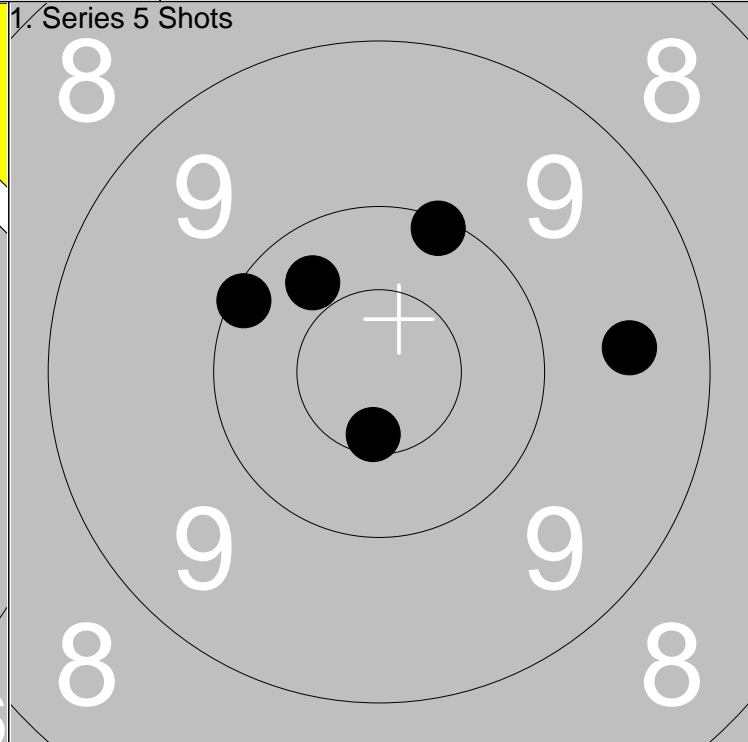

1: 10.2 ↑	Series 47.0
2: 10.4 →	
3: *10.4 ↘	Total 272.0
4: *10.7 →	
5: 7.6 ←	

1: 10.1 ↖	Series 49.0
2: 10.1 ↑	
3: 10.3 ↖	Total 321.0
4: 9.5 →	
5: *10.6 ↓	

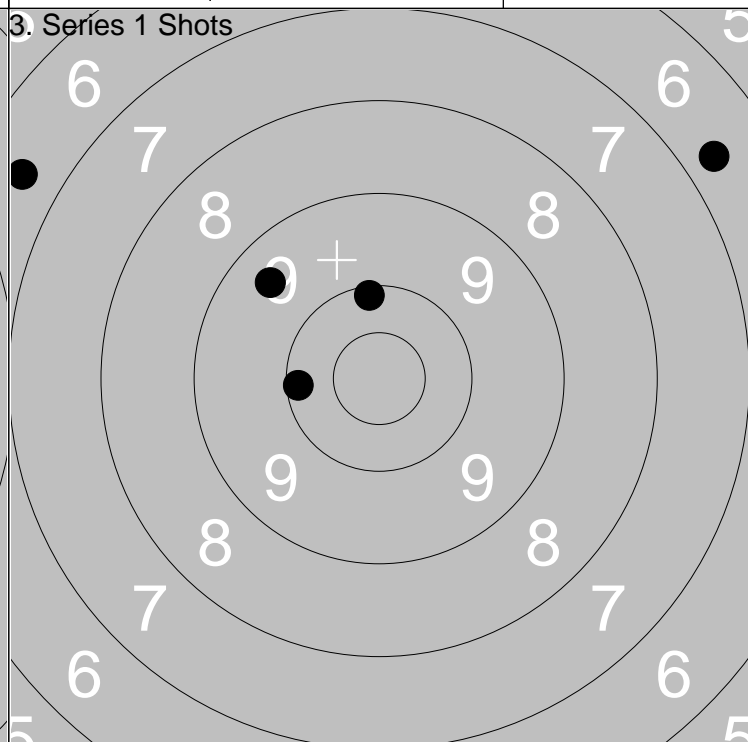
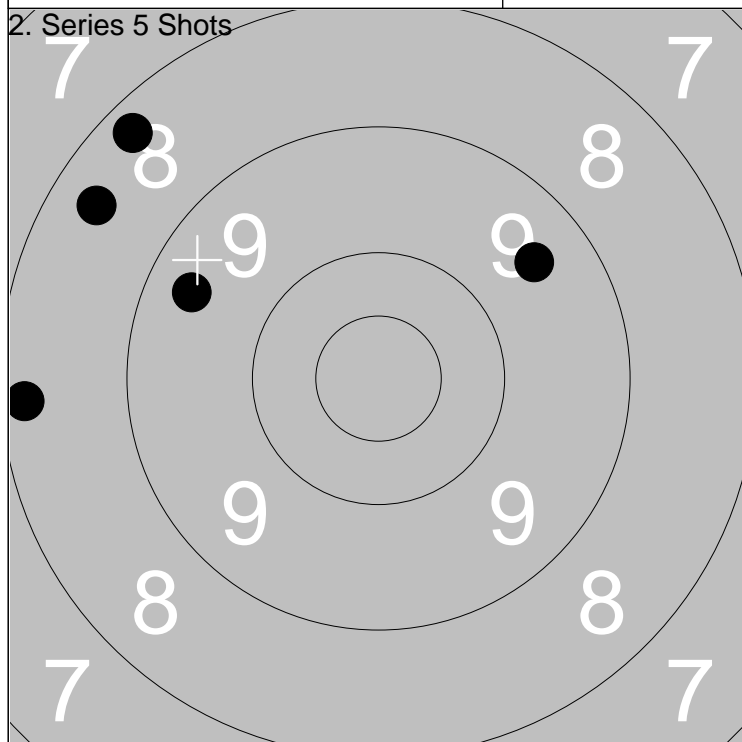

1: 8.4 ↖	Series 42.0
2: 8.3 ↗	
3: 8.2 ←	Total 363.0
4: 9.5 ↗	
5: 9.4 ←	

1: 6.7 ↗	Series 41.0
2: 10.1 ←	
3: 6.6 ↖	Total 404.0
4: 10.1 ↑	
5: 9.5 ↖	

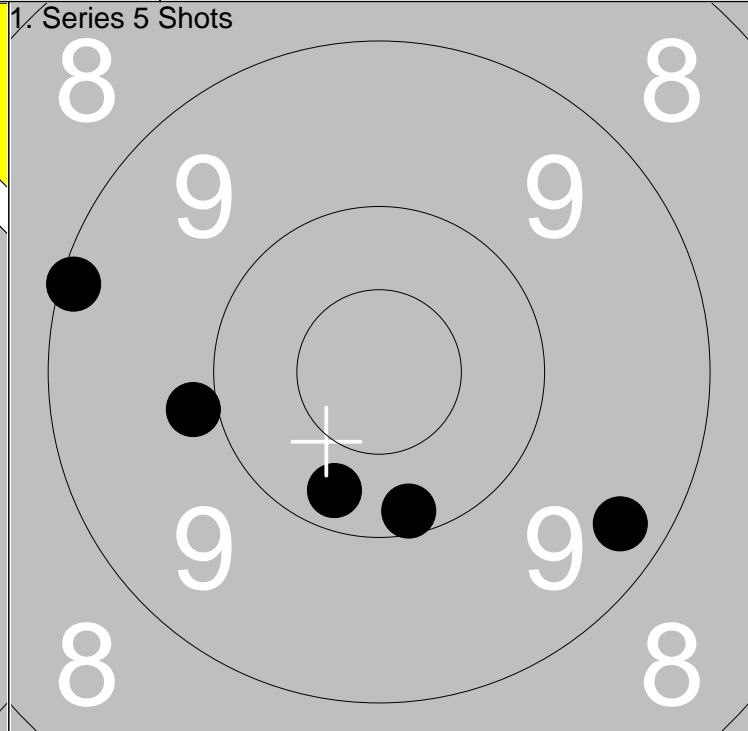
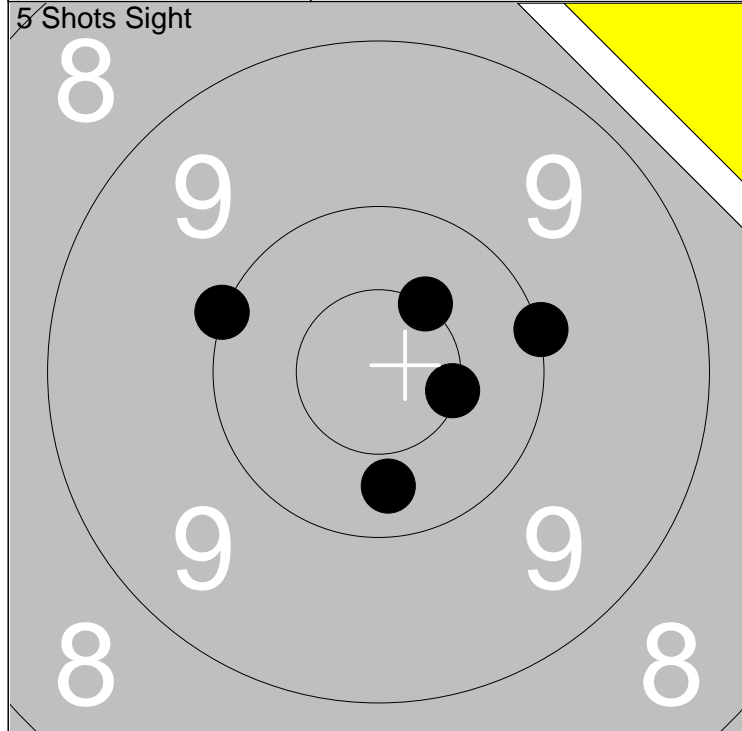

1: *10.5 ↗	Series	50.0
2: *10.5 →		
3: 10.3 ↓	Total	272.0
4: 10.0 →		
5: 10.0 ←		

1: 9.1 ←	Series	47.0
2: 9.9 ←		
3: 10.2 ↓	Total	319.0
4: 9.3 →		
5: 10.2 ↓		

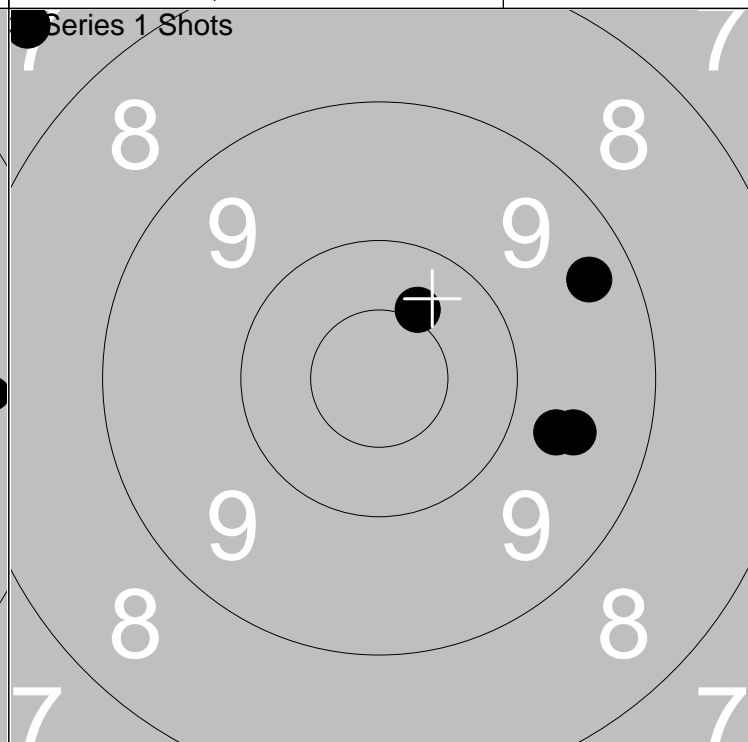
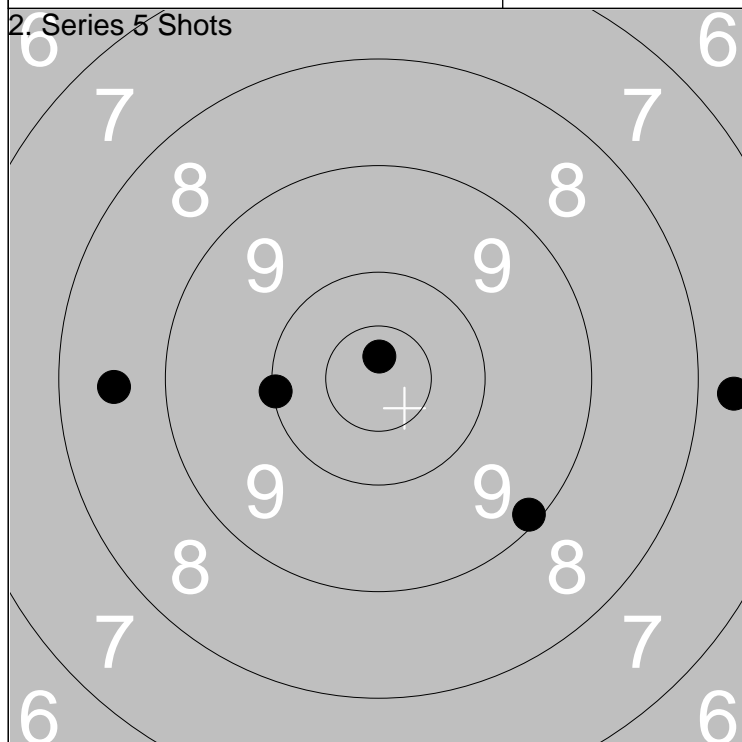

1: *10.8 ↑	Series	44.0
2: 7.7 →		
3: 8.5 ←	Total	363.0
4: 10.0 ←		
5: 9.1 ↓		

1: 9.6 →	Series	44.0
2: 9.7 →		
3: *10.4 ↗	Total	407.0
4: 9.3 →		
5: 7.4 ↖		

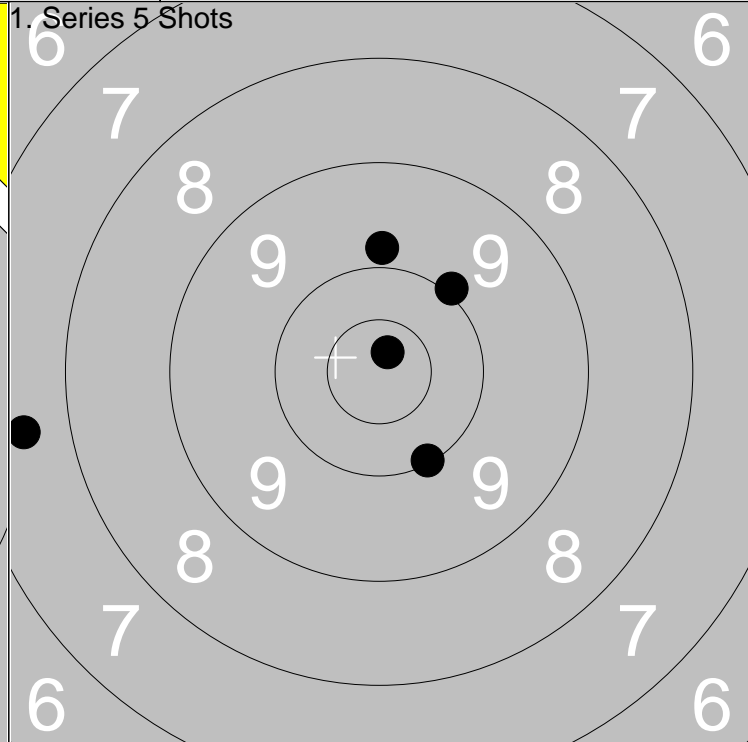
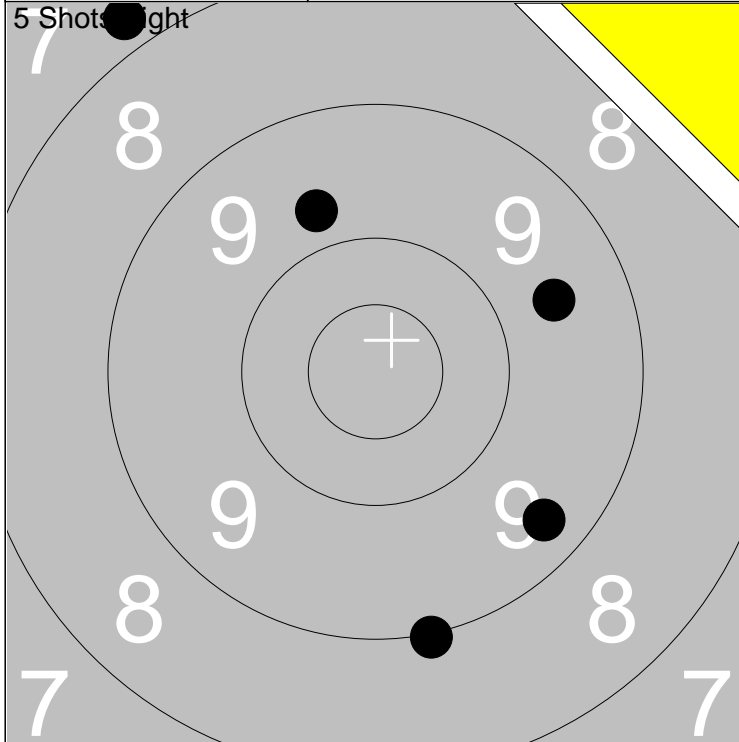

1: 9.0 ↓	Series	43.0
2: 9.6 →		
3: 9.4 ↓	Total	271.0
4: 7.8 ↗		
5: 9.7 ↗		

1: 7.6 ←	Series	46.0
2: 9.8 ↑		
3: 10.1 ↓	Total	317.0
4: *10.8 ↗		
5: 10.0 ↗		

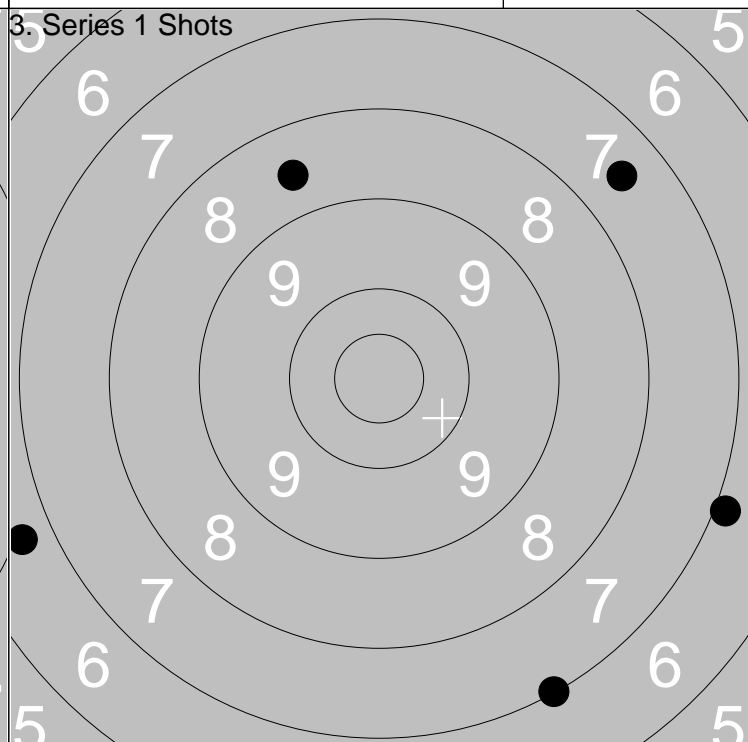
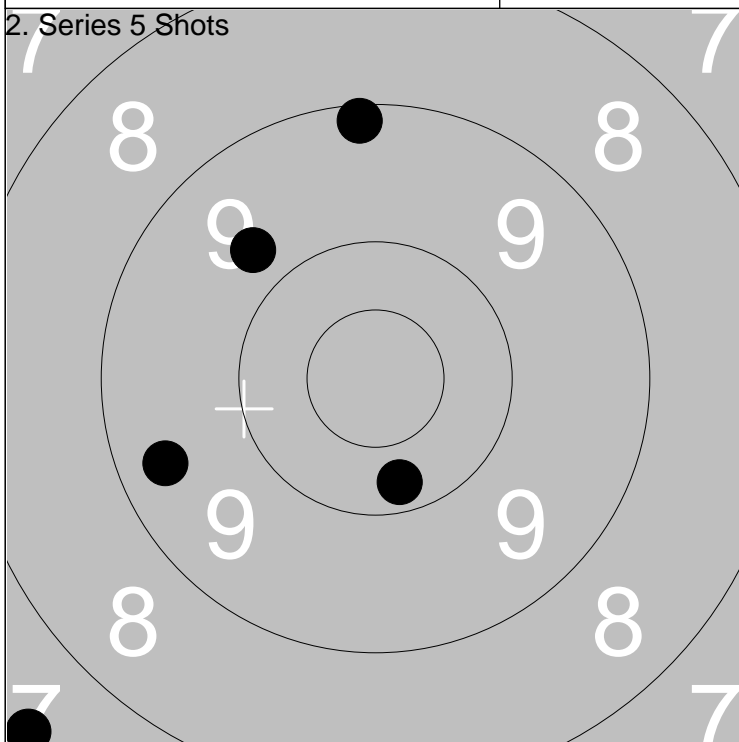

1: 9.1 ↑	Series	44.0
2: 9.7 ↖		
3: 9.4 ←	Total	361.0
4: 10.2 ↓		
5: 7.4 ↙		

1: 7.0 ↓	Series	34.0
2: 6.9 →		
3: 7.5 ↗	Total	395.0
4: 8.6 ↖		
5: 6.7 ←		

Relay 5	Lane 12	Johan Nilsson	
-------------------	-------------------	----------------------	--

300m	Ramselefors	B	Vb
------	-------------	---	----

2013-07-08	Tavelträffen B 2013	Ramselefors SKF	
------------	---------------------	-----------------	--

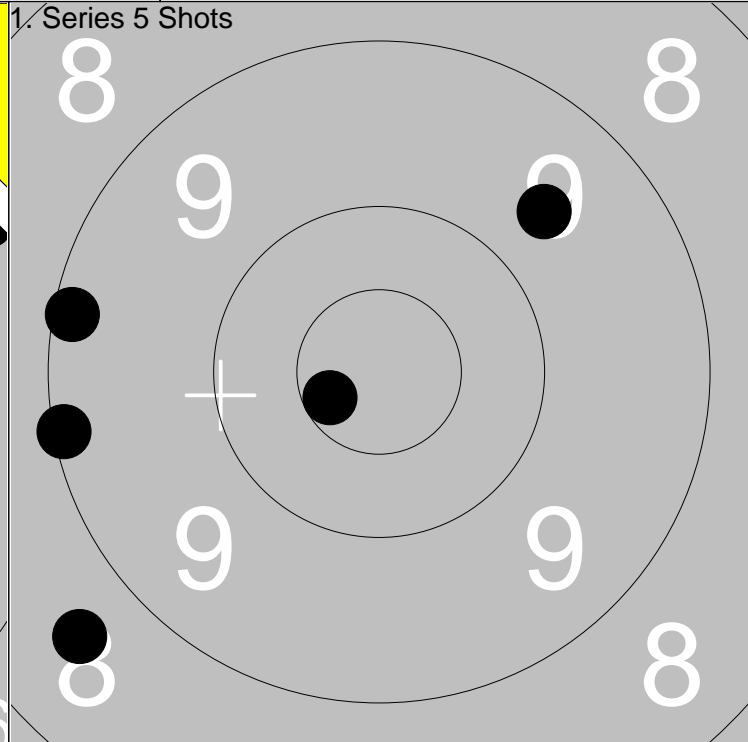
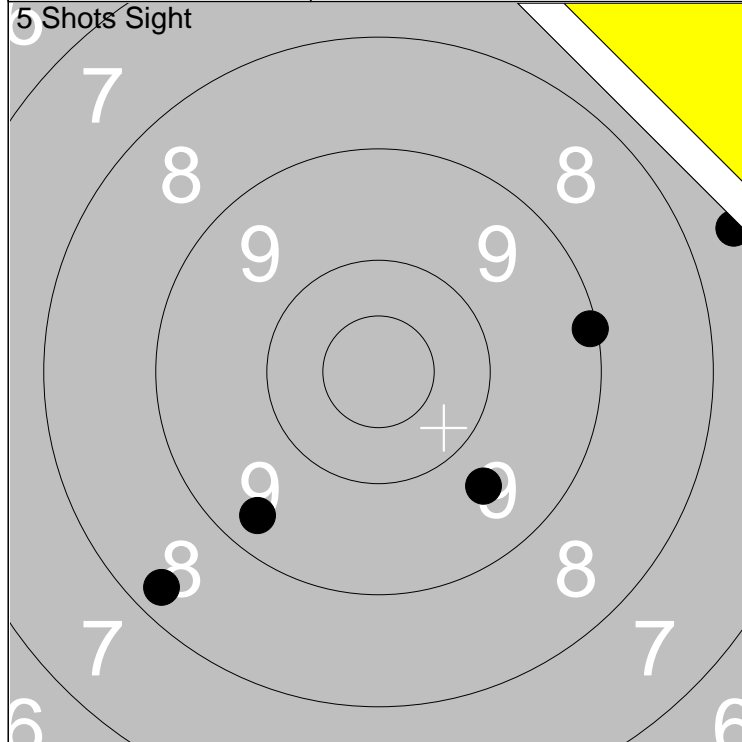

1: 8.3 ↙
2: 9.6 ↘
3: 9.3 ↙
4: 9.1 →
5: 7.6 →

Series	42.0
Total	270.0

1: 8.6 ↙
2: 9.1 ←
3: 9.6 ↗
4: *10.6 ↙
5: 9.1 ←

Series	45.0
Total	315.0

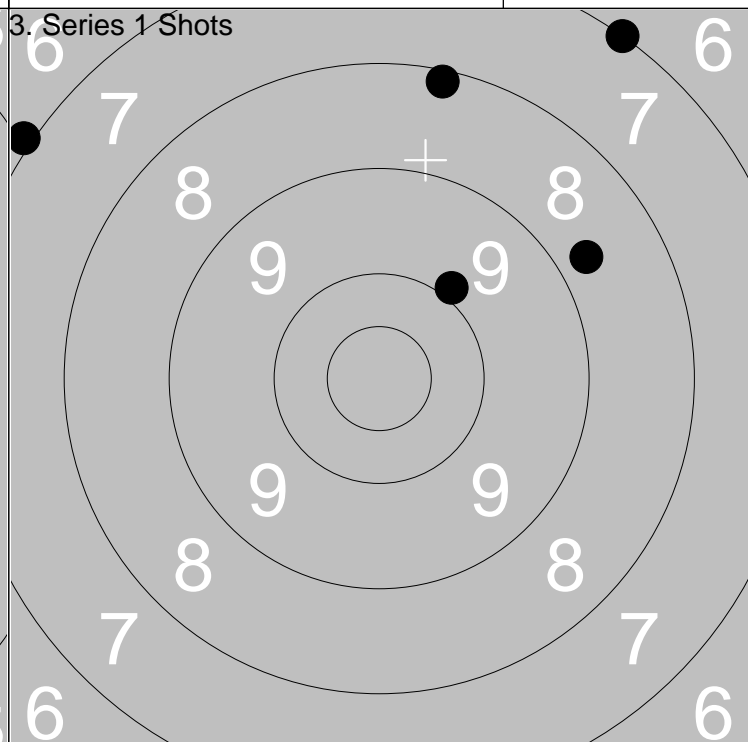
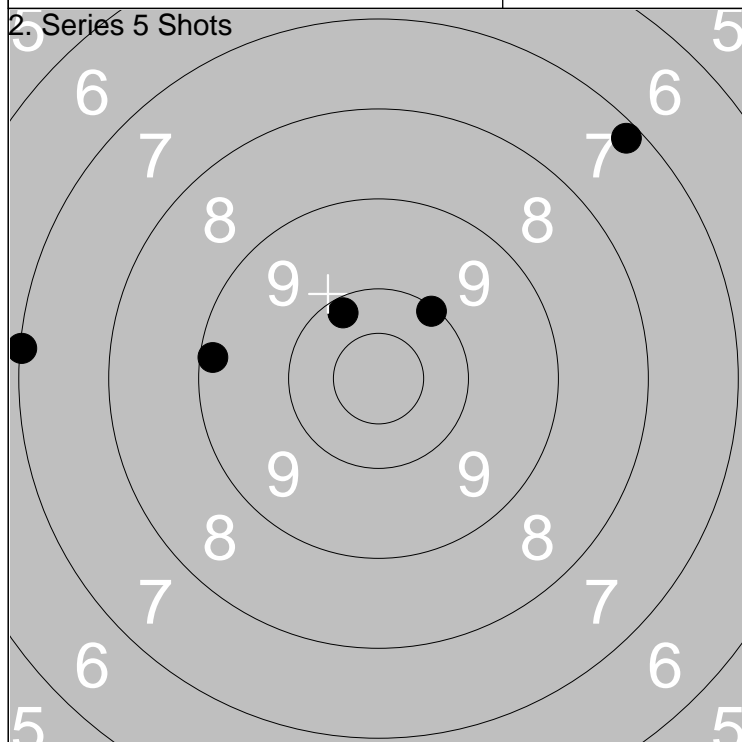

1: 7.1 ←
2: 10.2 ↗
3: 7.2 ↗
4: 9.2 ←
5: 10.1 ↗

Series	43.0
Total	358.0

1: 6.9 ↙
2: 8.1 ↑
3: 7.0 ↗
4: 9.9 ↗
5: 8.7 ↗

Series	38.0
Total	396.0

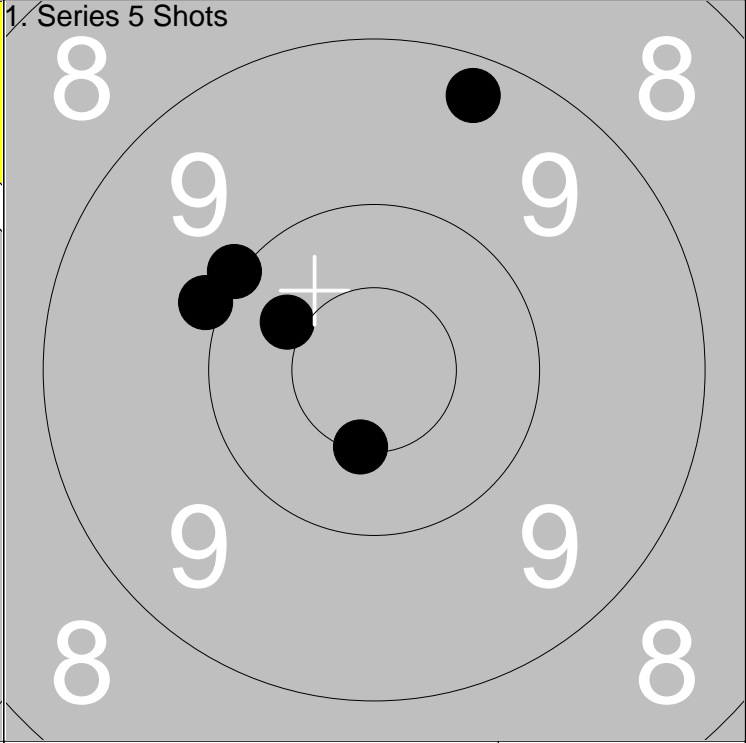
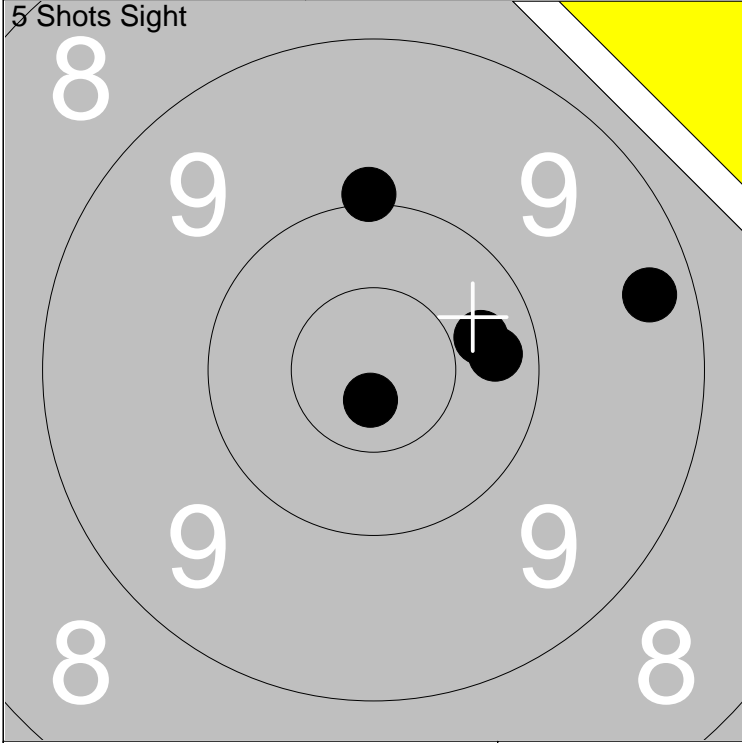

1: 10.0 ↑	Series	49.0
2: 10.3 →		
3: 9.3 →	Total	267.0
4: *10.8 ↓		
5: 10.3 →		

1: 10.4 ↖	Series	48.0
2: 9.9 ↖		
3: 9.3 ↑	Total	315.0
4: *10.5 ↓		
5: 10.0 ↖		

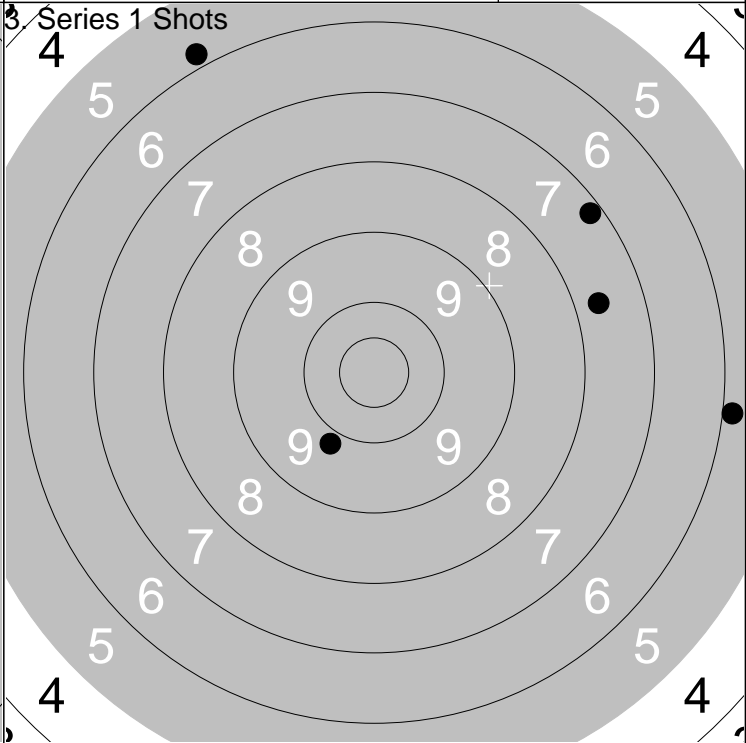
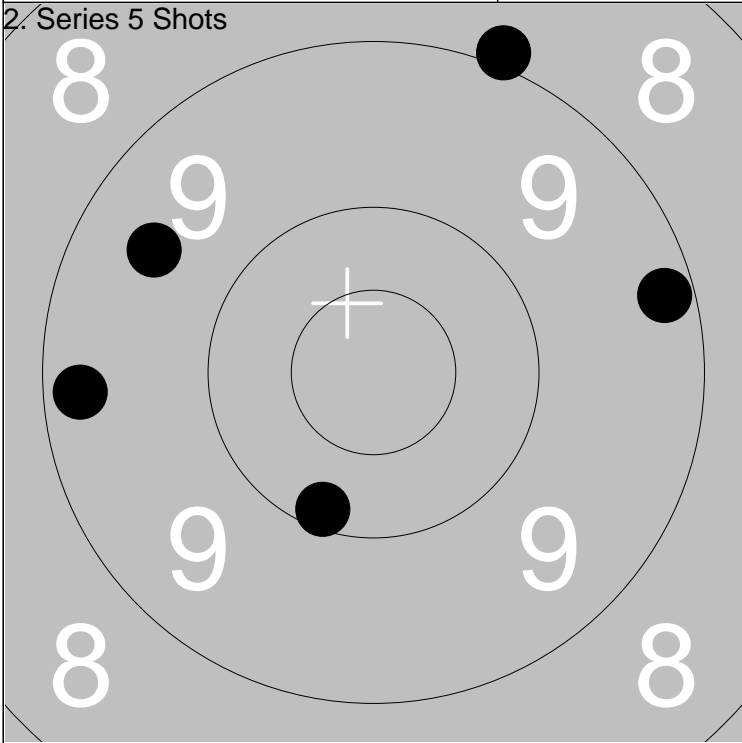

1: 9.5 ↖	Series	45.0
2: 10.1 ↓		
3: 8.9 ↑	Total	360.0
4: 9.3 ←		
5: 9.2 →		

1: 5.9 →	Series	33.0
2: 7.7 →		
3: 9.8 ↓	Total	393.0
4: 7.2 ↗		
5: 5.8 ↖		

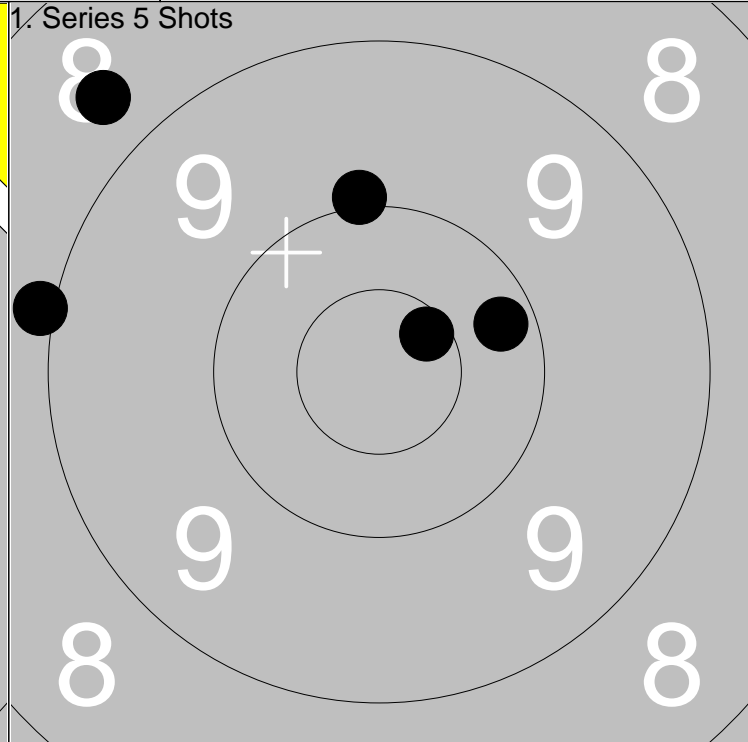
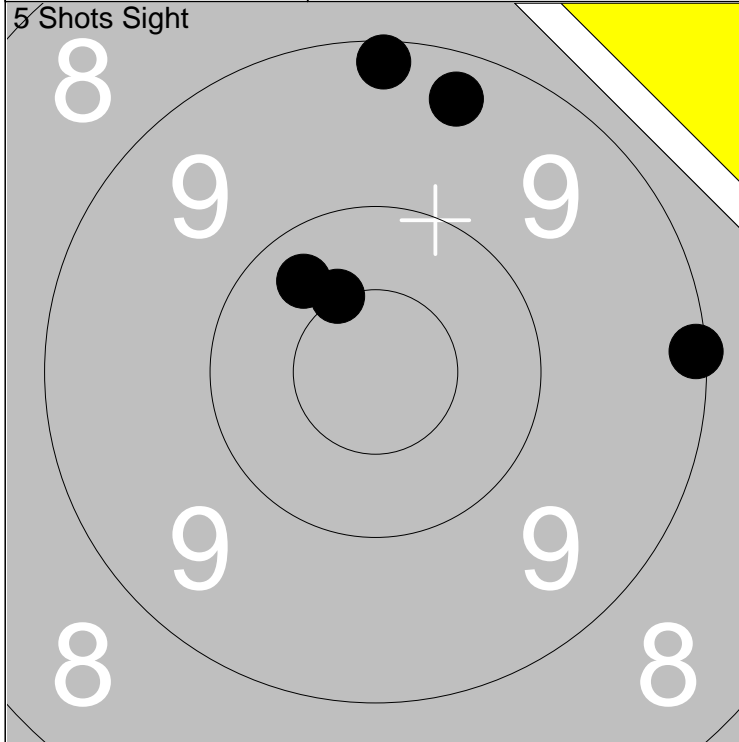

1: 9.2 ↑
2: *10.5 ↖
3: 10.3 ↖
4: 9.3 ↑
5: 9.1 →

Series	47.0
Total	267.0

1: 10.0 ↑
2: 8.9 ←
3: 8.7 ↖
4: *10.6 ↗
5: 10.2 →

Series	46.0
Total	313.0

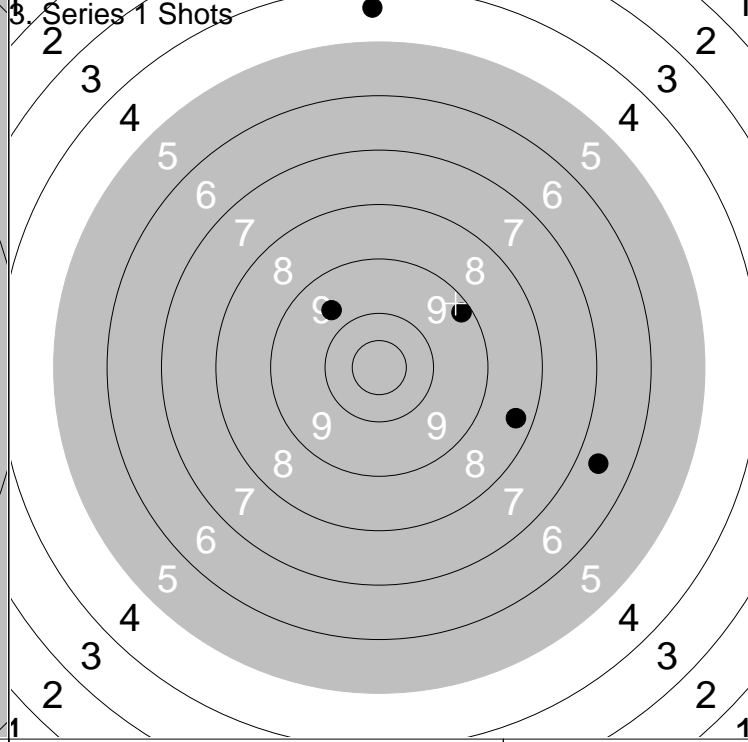
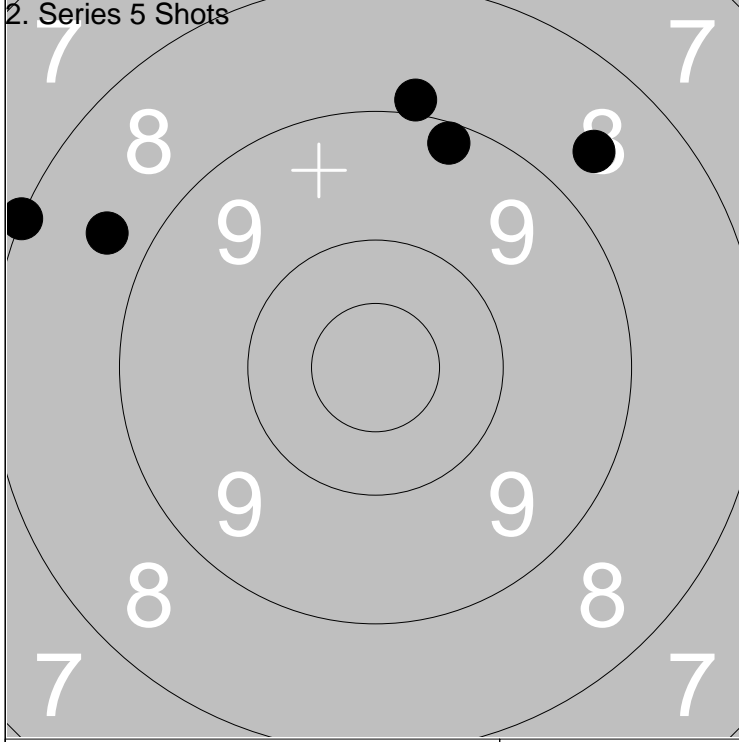

1: 8.7 ↖
2: 9.2 ↑
3: 8.0 ↖
4: 8.9 ↑
5: 8.6 ↗

Series	41.0
Total	354.0

1: 9.2 ↗
2: 8.3 →
3: 6.6 →
4: 9.7 ↖
5: 4.4 ↑

Series	36.0
Total	390.0

Relay 5	Lane 15	Anders Andersson	
-------------------	-------------------	-------------------------	--

300m	Hammerdal	B	Jä
------	-----------	---	----

2013-07-08	Tavelträffen B 2013	Ramselefors SKF
------------	---------------------	-----------------

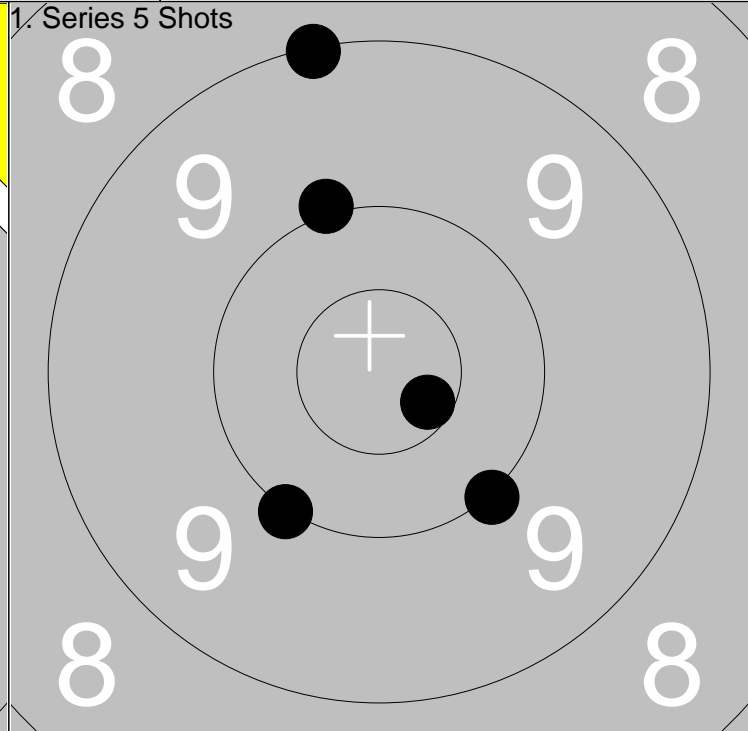
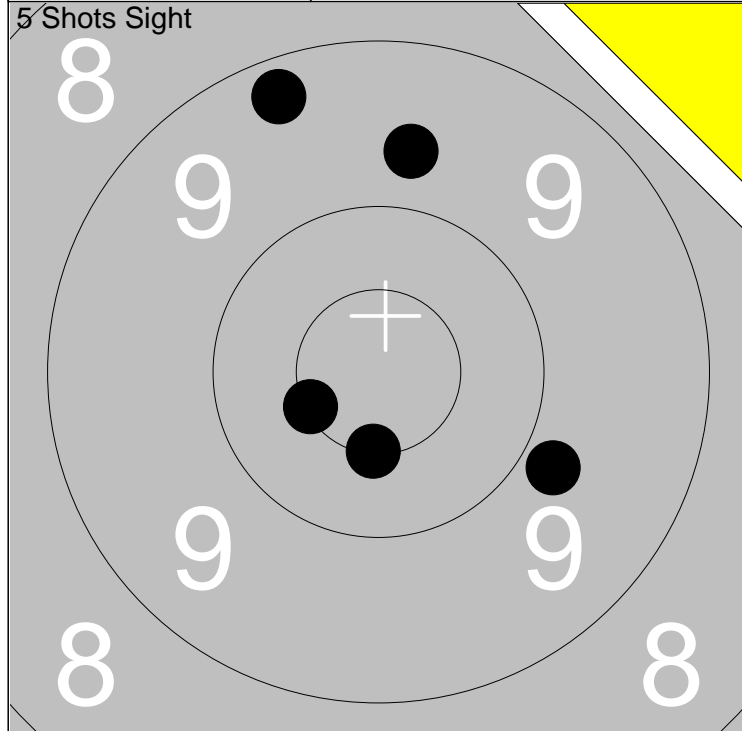

1: *10.5 ↙	Series	47.0
2: *10.5 ↓		
3: 9.8 →	Total	266.0
4: 9.3 ↑		
5: 9.7 ↑		

1: 10.0 ↙	Series	49.0
2: *10.6 ↘		
3: 10.0 ↑	Total	315.0
4: 9.1 ↑		
5: 10.0 ↘		

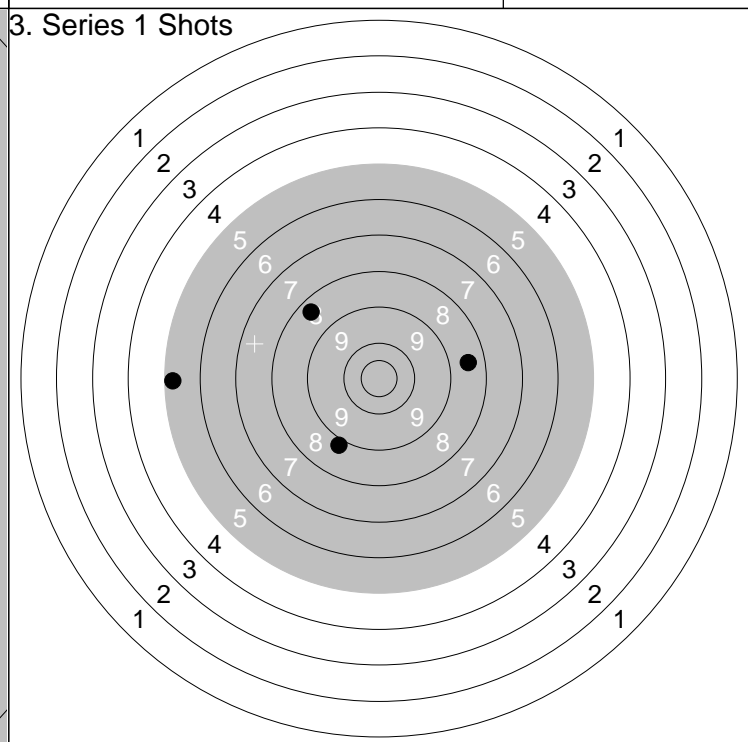
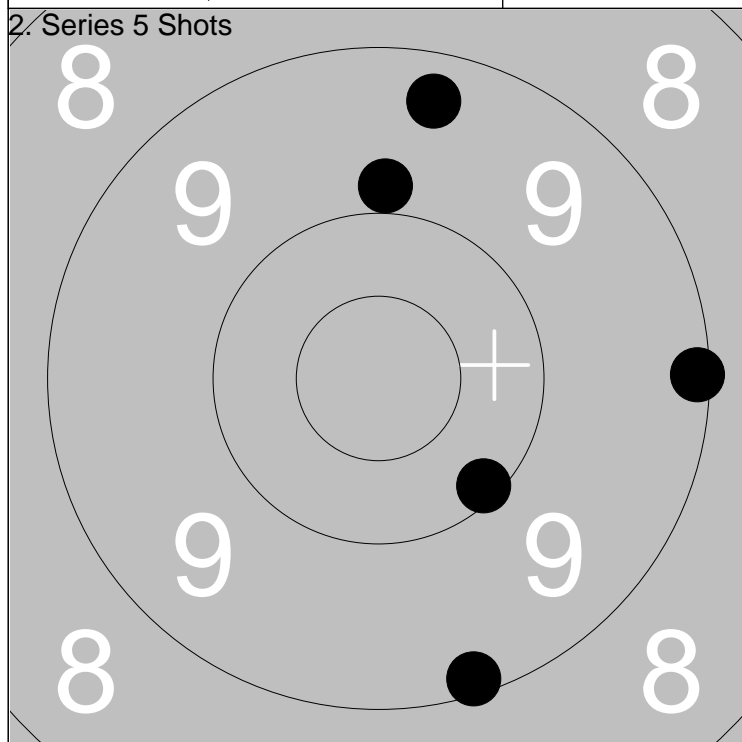

1: 9.1 →	Series	46.0
2: 10.1 ↘		
3: 9.9 ↑	Total	361.0
4: 9.1 ↓		
5: 9.3 ↑		

1: 8.4 ↖	Series	29.0
2: 8.5 →		
3: 0.0 ↖	Total	390.0
4: 8.9 ↙		
5: 5.3 ←		

Relay **5** Lane **16** **Lars Evaldsson**

300m Göteborg B Vs

2013-07-08 Tavelträffen B 2013 Ramselefors SKF

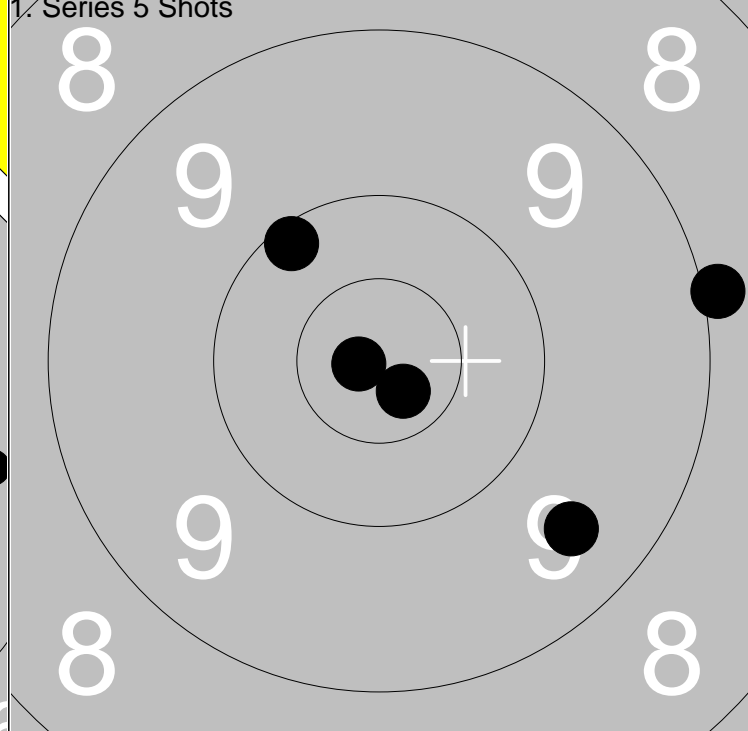
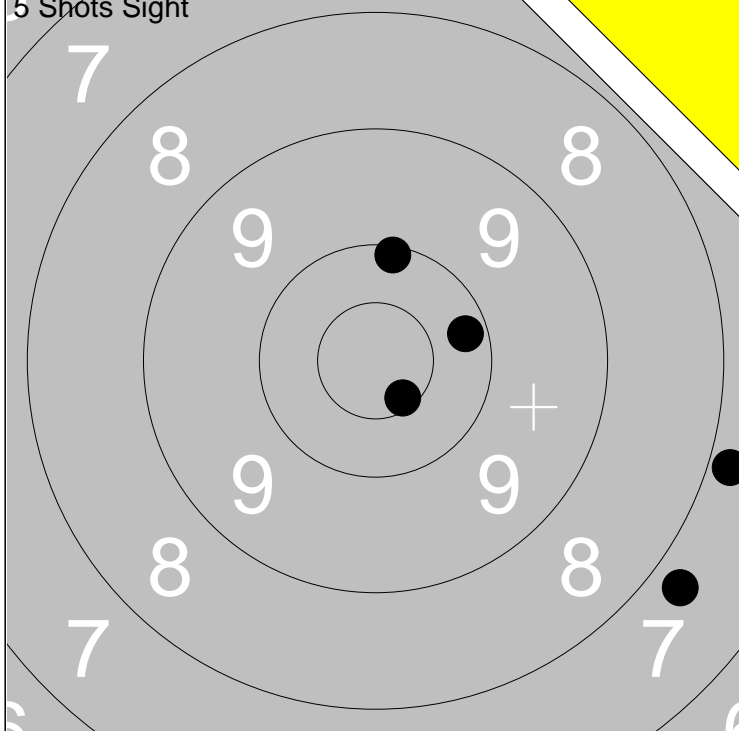

1: 10.2 →
2: 10.1 ↑
3: *10.6 ↘
4: 7.8 →
5: 7.8 ↘

Series	44.0
Total	266.0

1: *10.8 ←
2: *10.7 ↘
3: 10.1 ↖
4: 8.9 →
5: 9.5 ↘

Series	47.0
Total	313.0

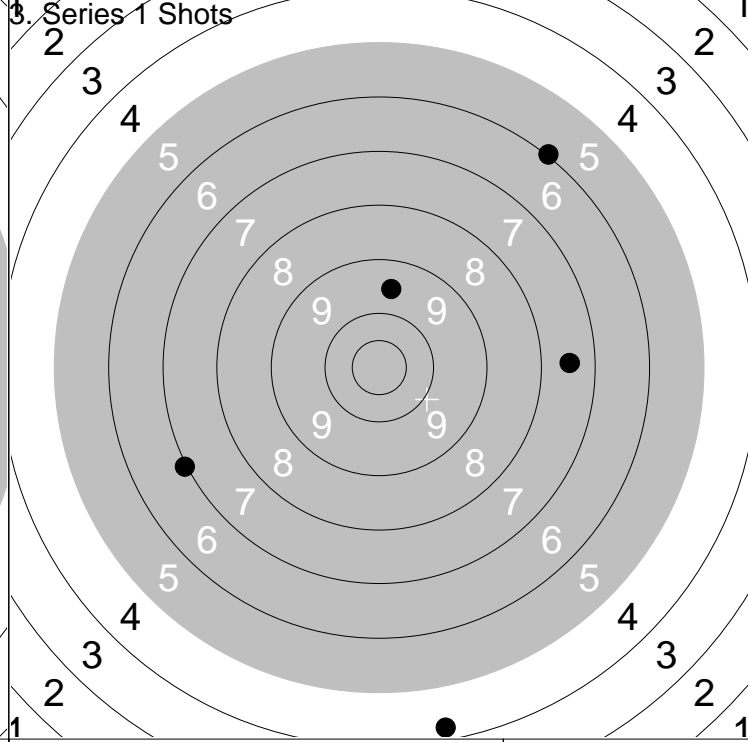
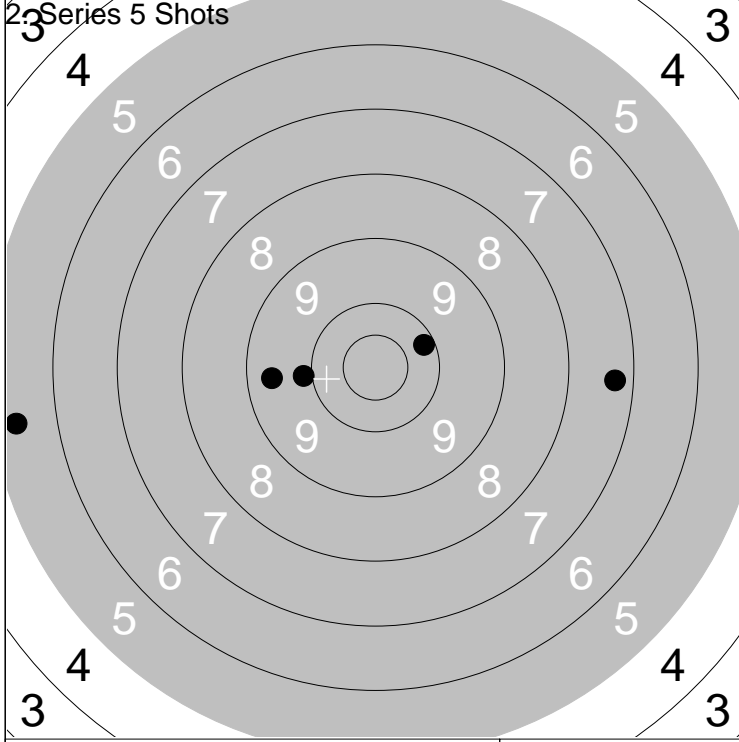

1: 10.2 →
2: 7.3 →
3: 5.4 ←
4: 9.9 ←
5: 9.4 ←

Series	40.0
Total	353.0

1: 9.6 ↑
2: 7.5 →
3: 6.0 ↗
4: 7.0 ←
5: 4.3 ↓

Series	33.0
Total	386.0

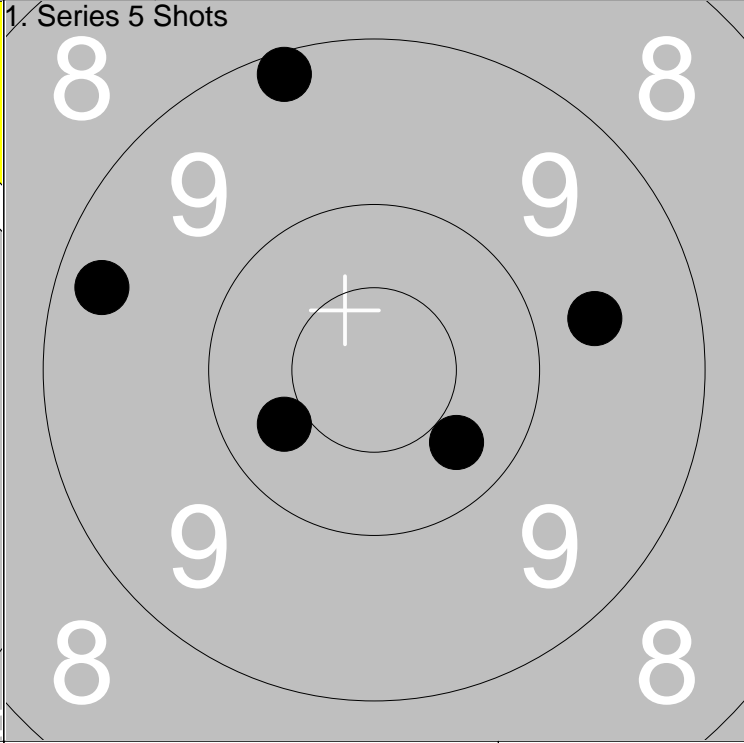
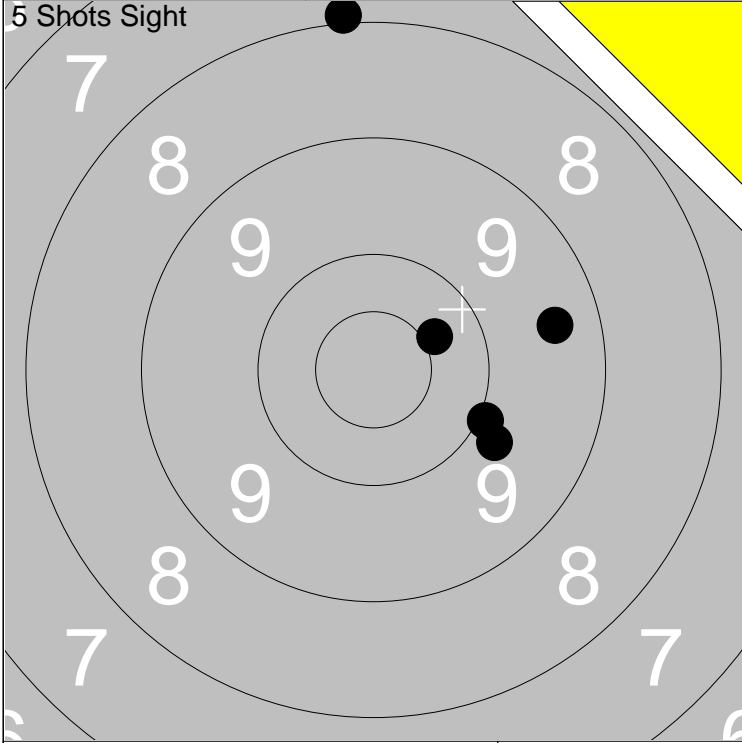

1: 10.0 ➔
2: 10.4 ↗
3: 9.8 ➔
4: 8.0 ↑
5: 9.4 ➔

Series	46.0
Total	265.0

1: 9.3 ←
2: 10.4 ↙
3: 9.2 ↑
4: 9.7 ➔
5: 10.3 ↘

Series	47.0
Total	312.0

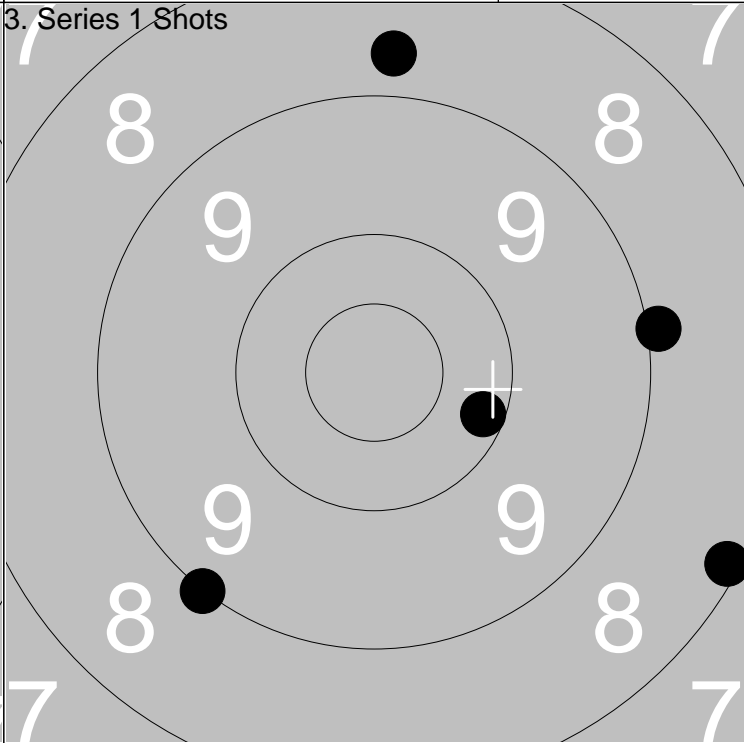
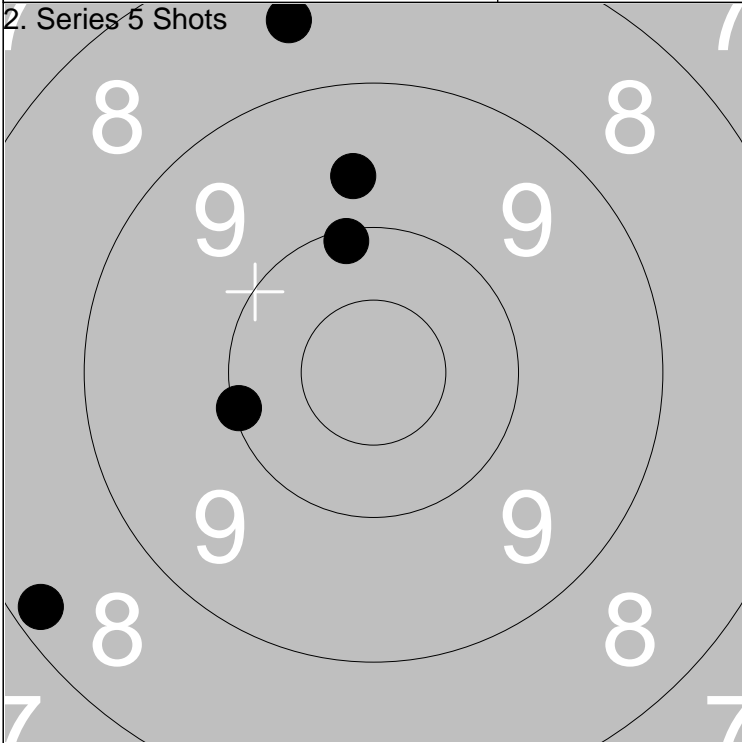

1: 8.5 ↑
2: 10.1 ↑
3: 9.7 ↑
4: 10.1 ←
5: 8.2 ↙

Series	45.0
Total	357.0

1: 8.7 ↑
2: 8.1 ➔
3: 9.0 ↙
4: 8.9 ➔
5: 10.2 ➔

Series	43.0
Total	400.0

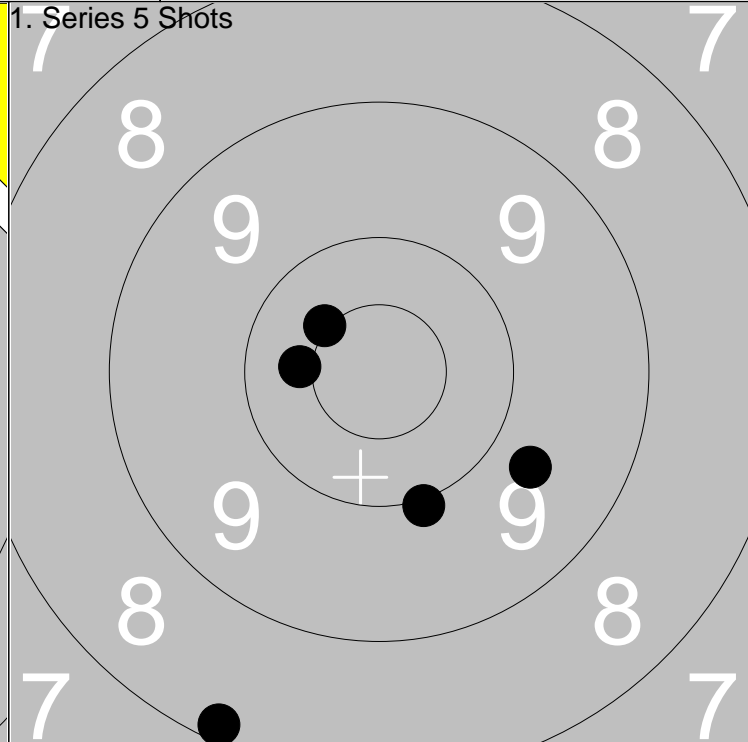
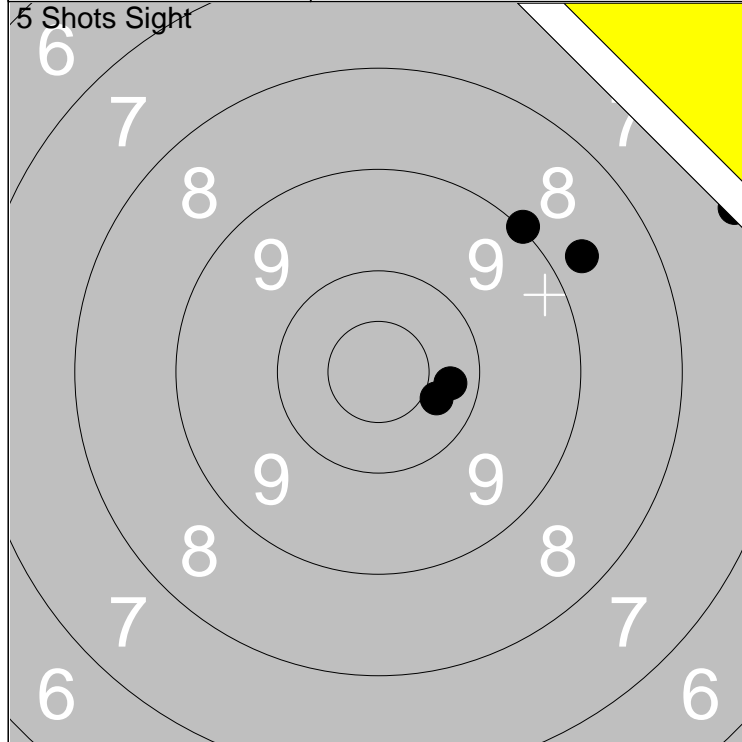

1: 10.3 →
2: 10.4 →
3: 8.7 ↗
4: 9.0 ↗
5: 7.2 ↗

Series	44.0
Total	264.0

1: *10.5 ↖
2: 8.2 ↓
3: 9.7 →
4: 10.0 ↓
5: 10.4 ←

Series	47.0
Total	311.0

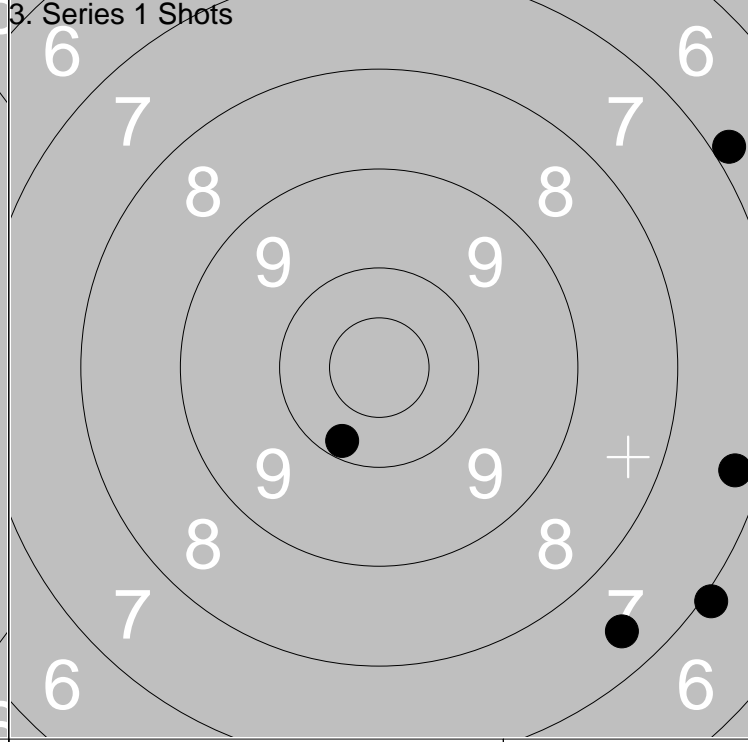
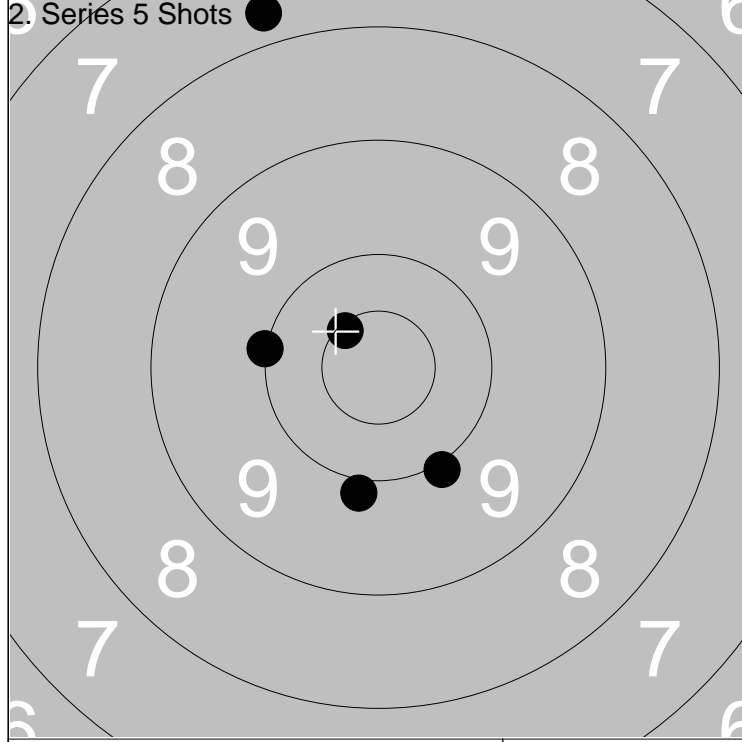

1: 9.9 ↓
2: 10.0 ↓
3: *10.5 ↖
4: 7.8 ↑
5: 10.0 ←

Series	46.0
Total	357.0

1: 7.0 →
2: 10.2 ↓
3: 6.9 ↗
4: 7.3 →
5: 7.4 ↓

Series	37.0
Total	394.0

Relay	Lane	Alf Edin	
5	20		

300m	Ale	B	No
------	-----	---	----

2013-07-08	Tavelträffen B 2013	Ramselefors SKF
------------	---------------------	-----------------

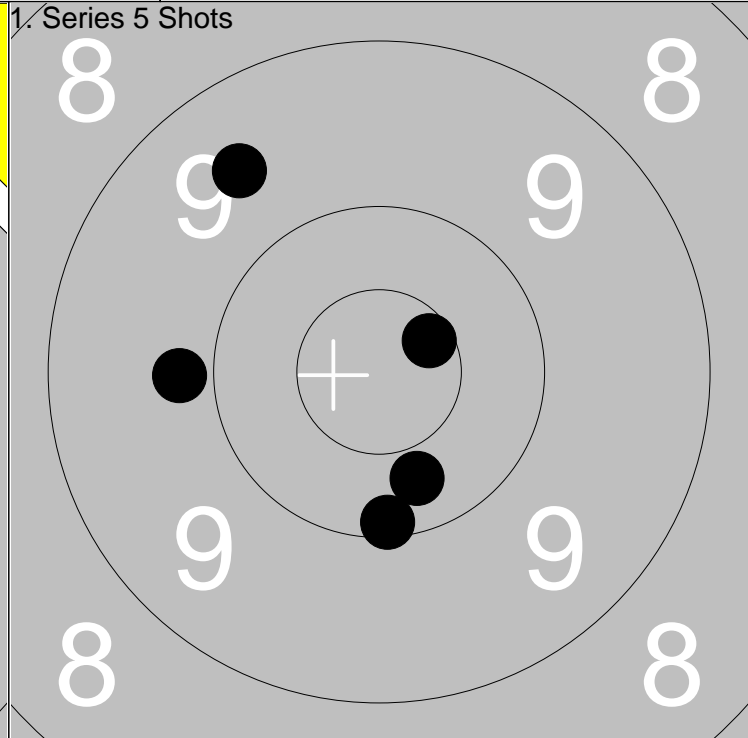
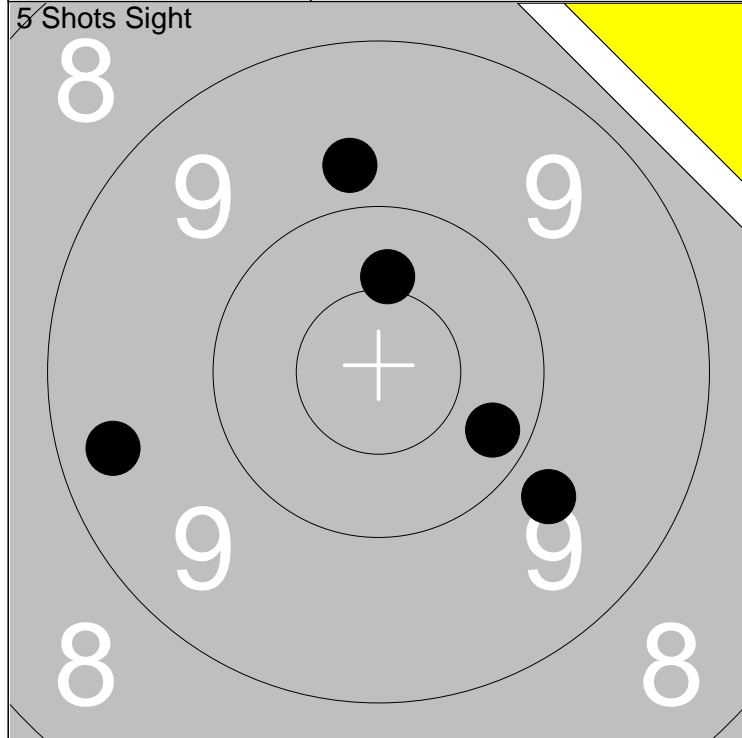

1: 10.2 ➤
 2: *10.4 ↑
 3: 9.8 ➤
 4: 9.8 ↑
 5: 9.4 ←

Series	47.0
Total	264.0

1: 9.5 ↖
 2: 9.8 ←
 3: 10.1 ↓
 4: *10.6 ↗
 5: 10.3 ↓

Series	48.0
Total	312.0

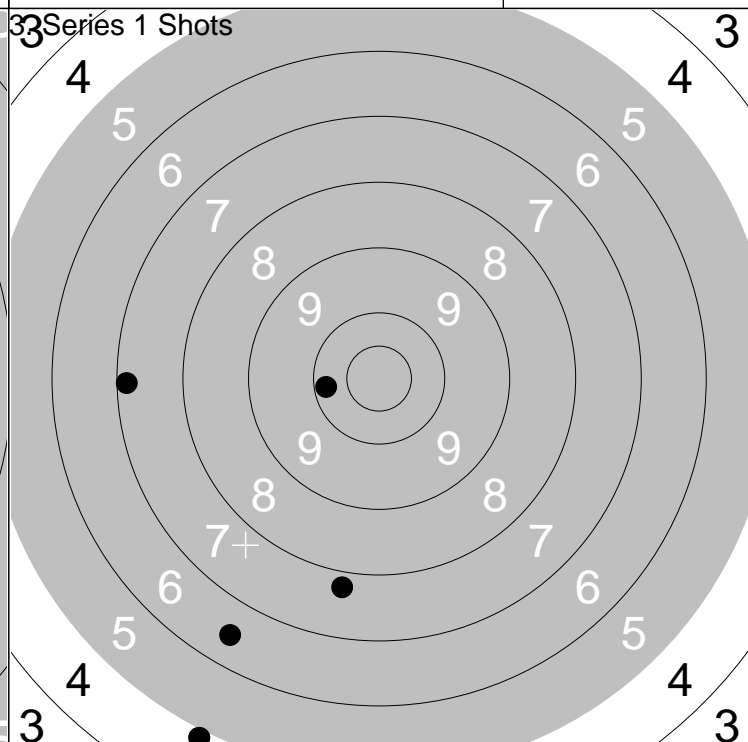
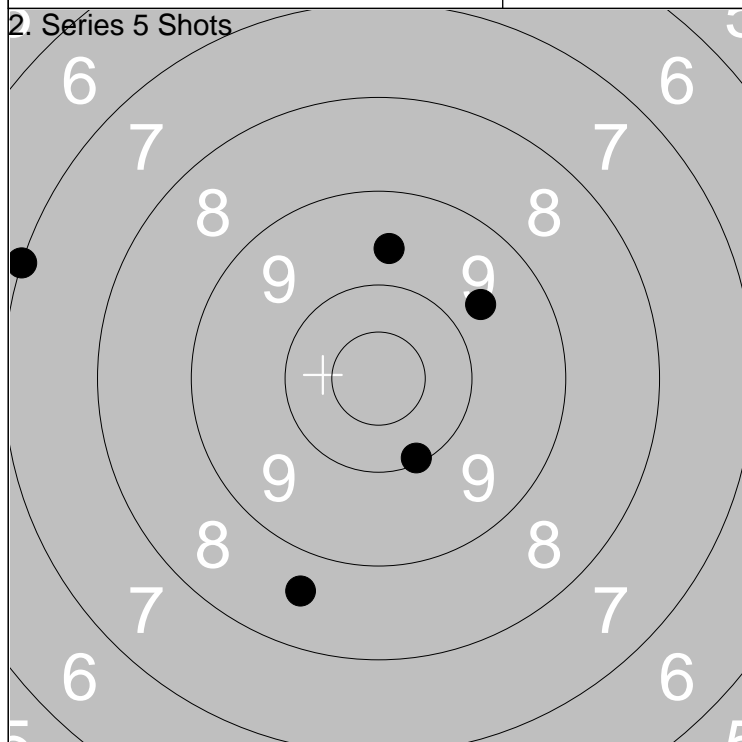

1: 9.6 ↑
 2: 9.7 ↗
 3: 7.0 ←
 4: 10.1 ↓
 5: 8.6 ↓

Series	43.0
Total	355.0

1: 6.5 ↓
 2: 7.2 ←
 3: 4.9 ↓
 4: 7.8 ↓
 5: 10.2 ←

Series	34.0
Total	389.0

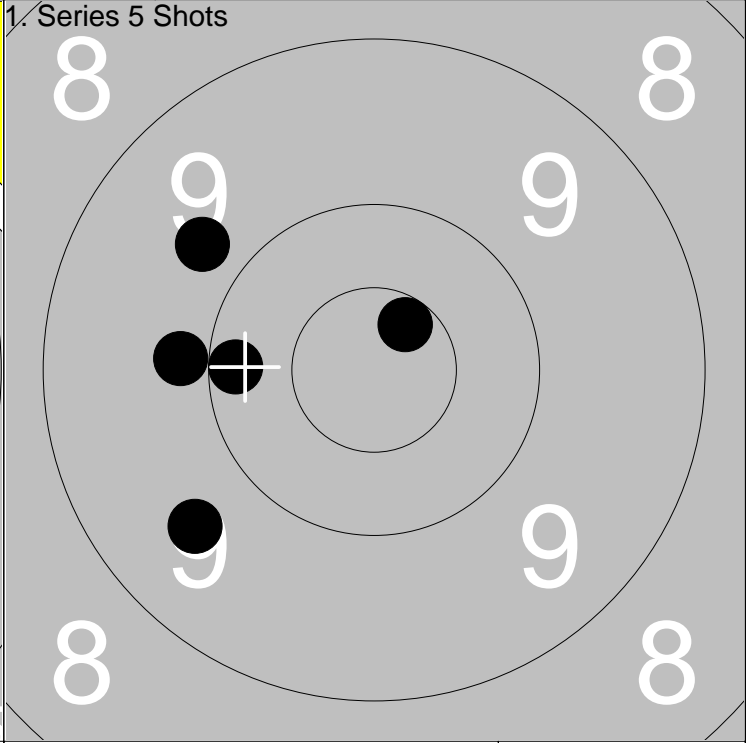
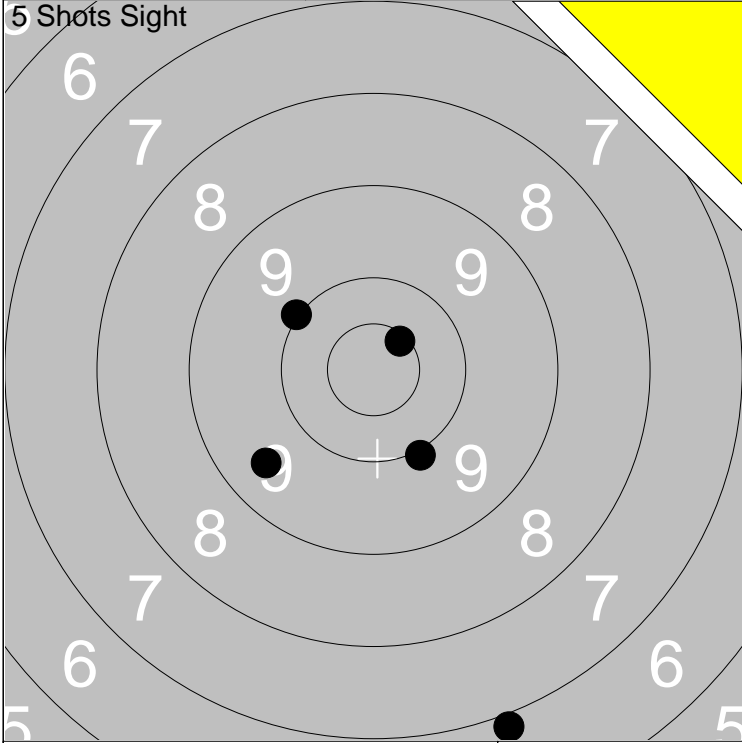

1: 10.0 ↘	Series 45.0
2: 10.0 ↖	
3: 9.5 ↙	Total 261.0
4: 6.9 ↓	
5: *10.6 ↗	

1: 9.7 ↖	Series 47.0
2: *10.6 ↗	
3: 9.9 ←	Total 308.0
4: 10.2 ←	
5: 9.6 ↙	

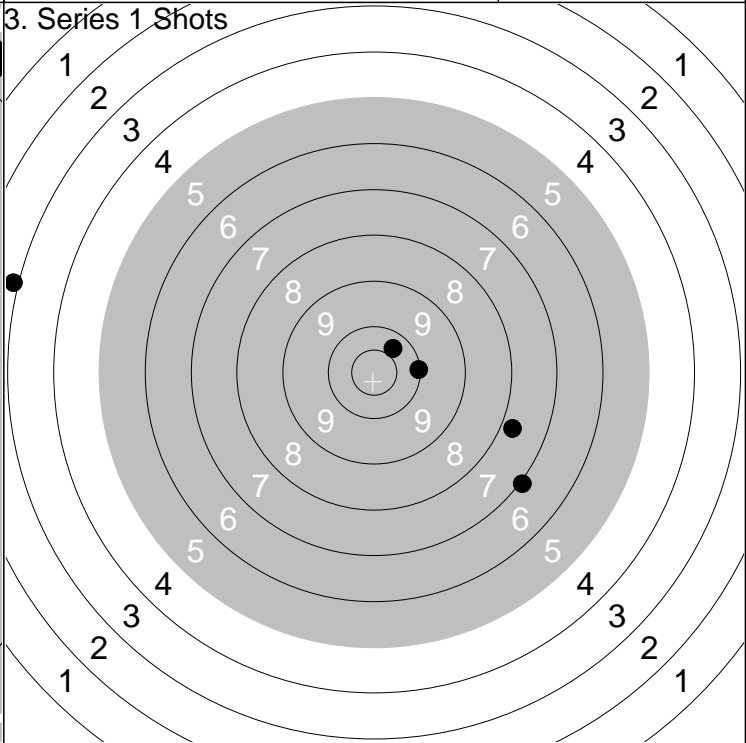
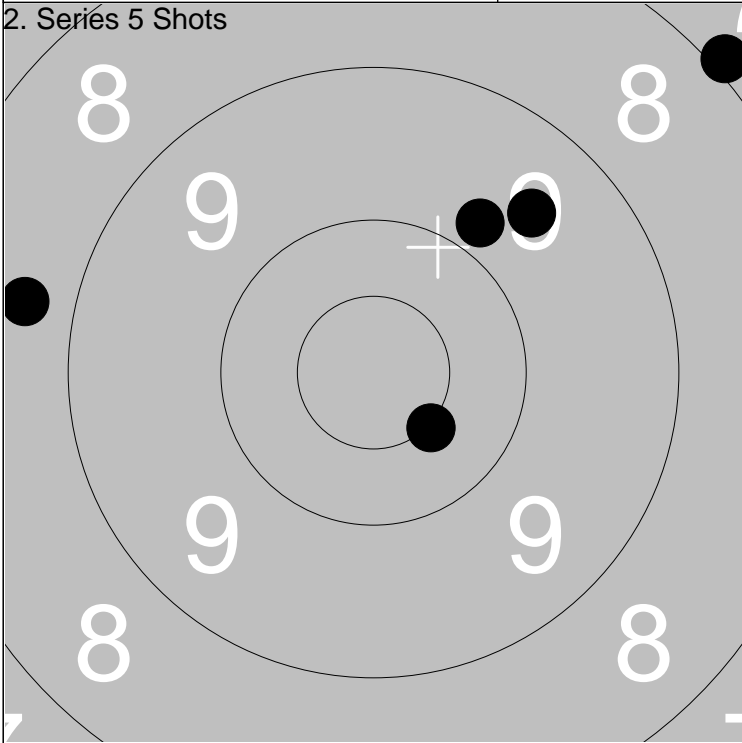

1: 7.9 ↗	Series 43.0
2: 9.6 ↗	
3: 9.8 ↗	Total 351.0
4: 8.7 ←	
5: *10.5 ↘	

1: 7.0 ↘	Series 36.0
2: 10.0 →	
3: 7.8 →	Total 387.0
4: 2.9 ←	
5: 10.3 ↗	

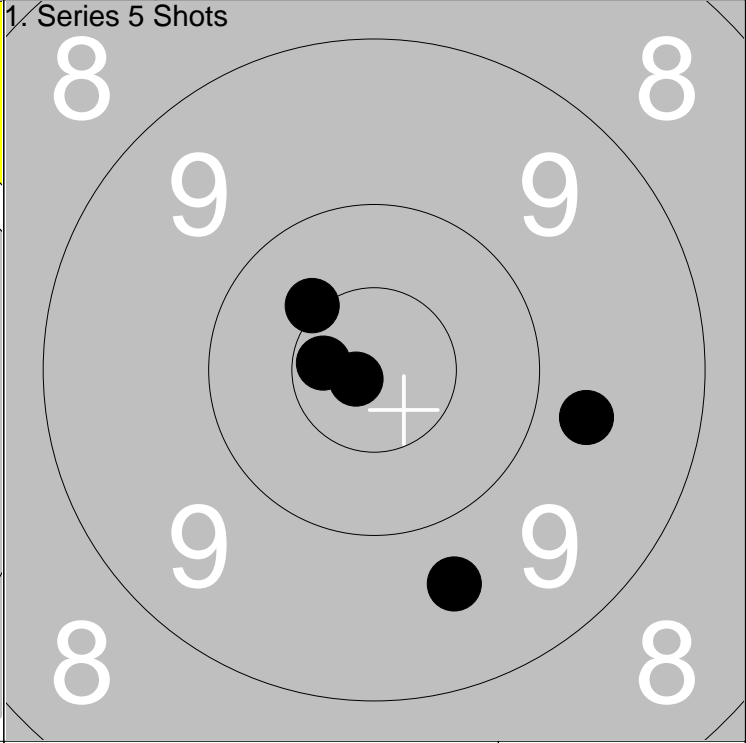
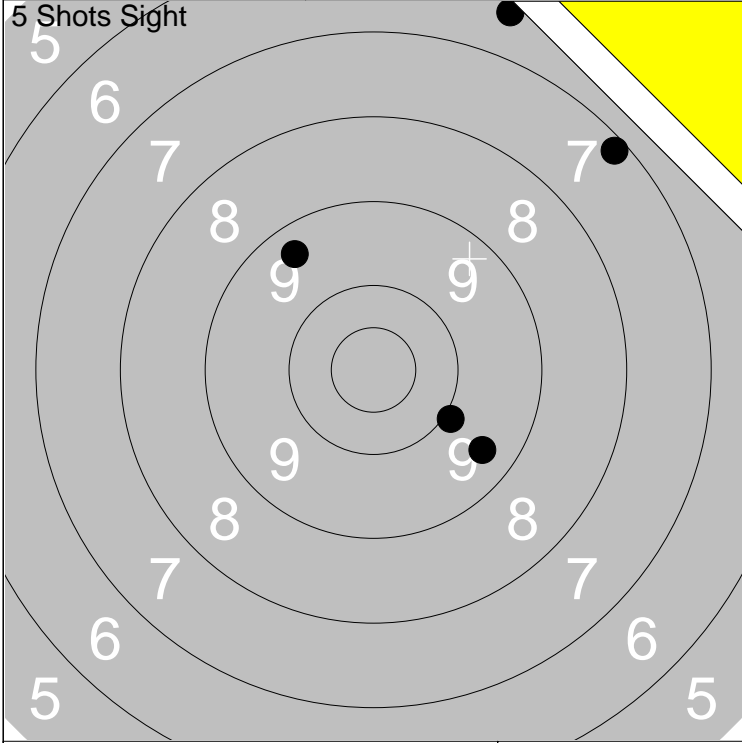

1: 9.4 ↗
2: 9.4 ↘
3: 9.9 ↘
4: 7.2 ↗
5: 6.5 ↗

Series	40.0
Total	260.0

1: *10.7 ↖
2: 9.6 ↘
3: 9.7 →
4: *10.5 ↖
5: *10.8 ↖

Series	48.0
Total	308.0

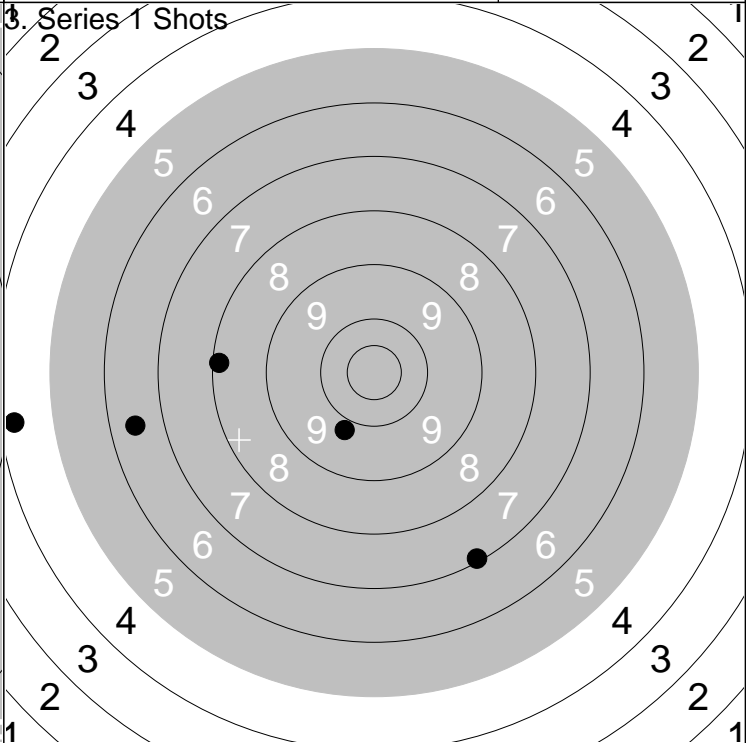
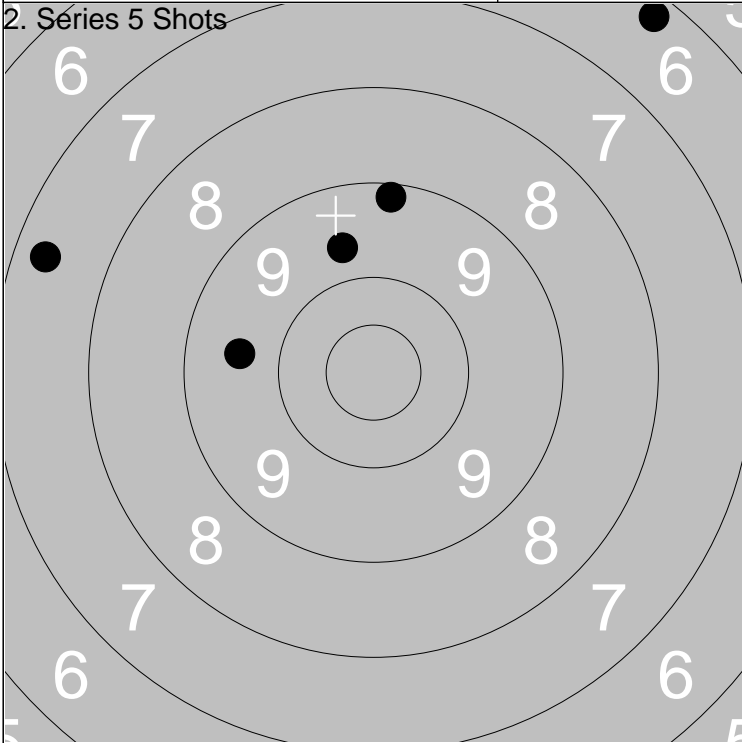

1: 9.6 ←
2: 7.4 ←
3: 9.7 ↗
4: 6.3 ↗
5: 9.2 ↗

Series	40.0
Total	348.0

1: 7.1 ↘
2: 6.5 ←
3: 9.8 ↘
4: 4.3 ←
5: 8.2 ←

Series	34.0
Total	382.0

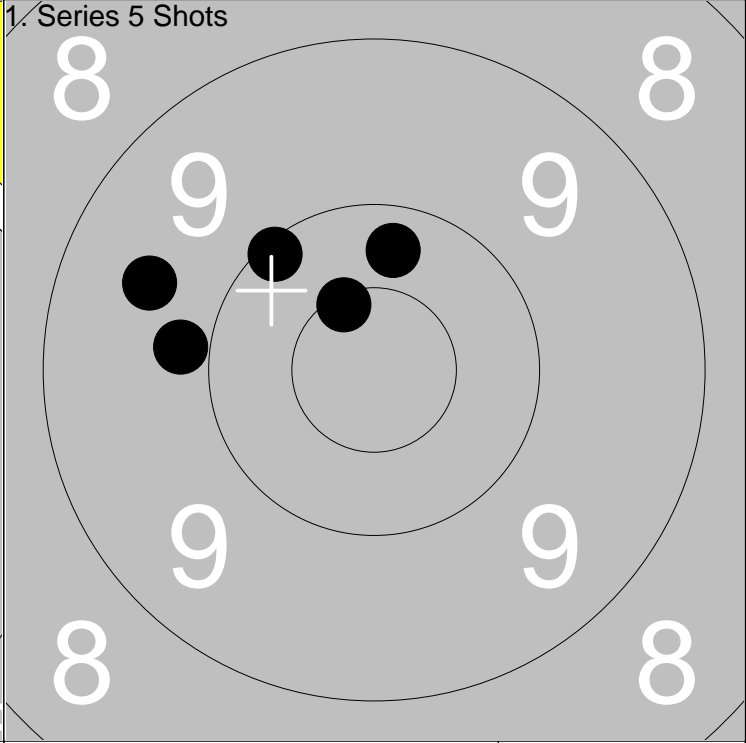
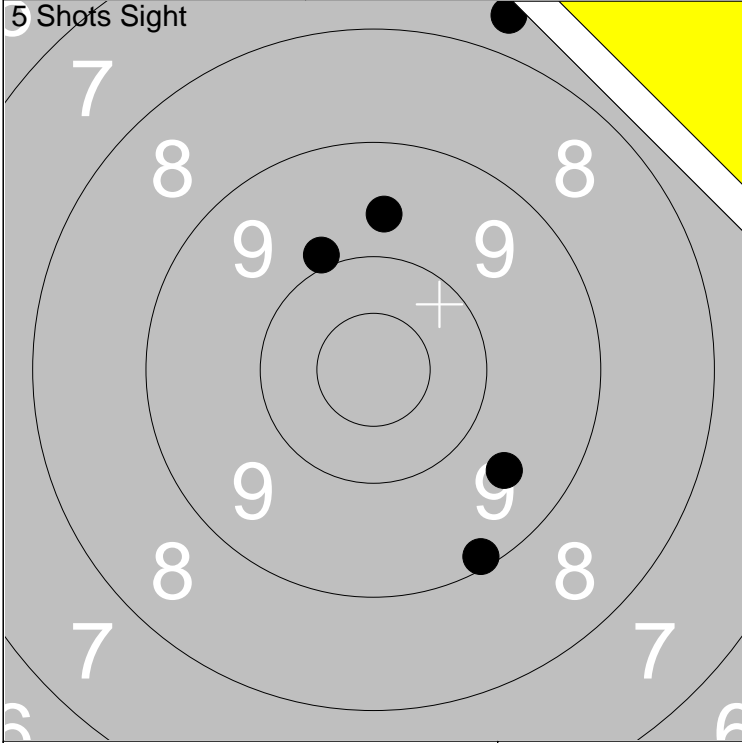

1: 9.1 ↘
2: 9.6 ↘
3: 9.7 ↑
4: 9.9 ↗
5: 7.7 ↗

Series	43.0
Total	253.0

1: 9.6 ↖
2: 10.1 ↗
3: *10.6 ↗
4: 9.9 ←
5: 10.3 ↑

Series	48.0
Total	301.0

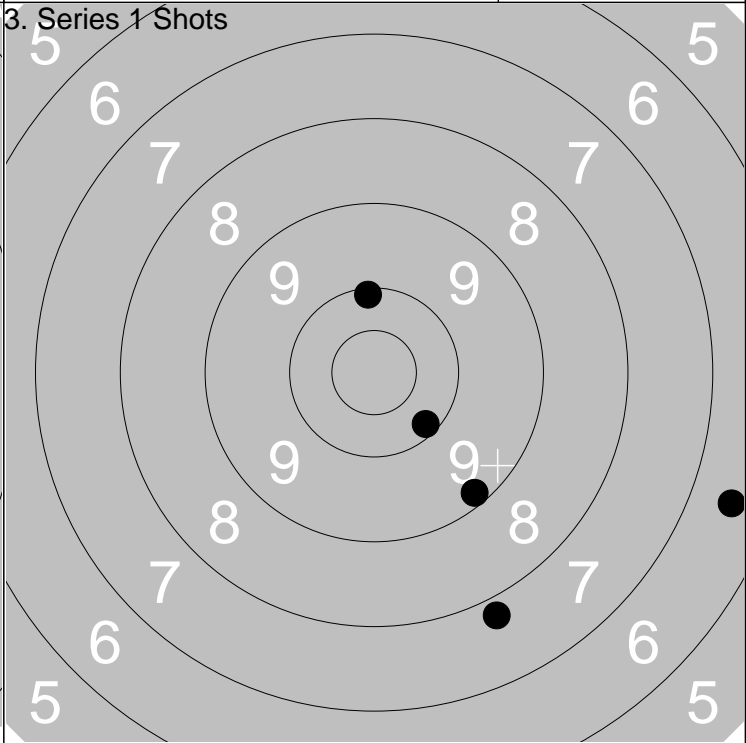
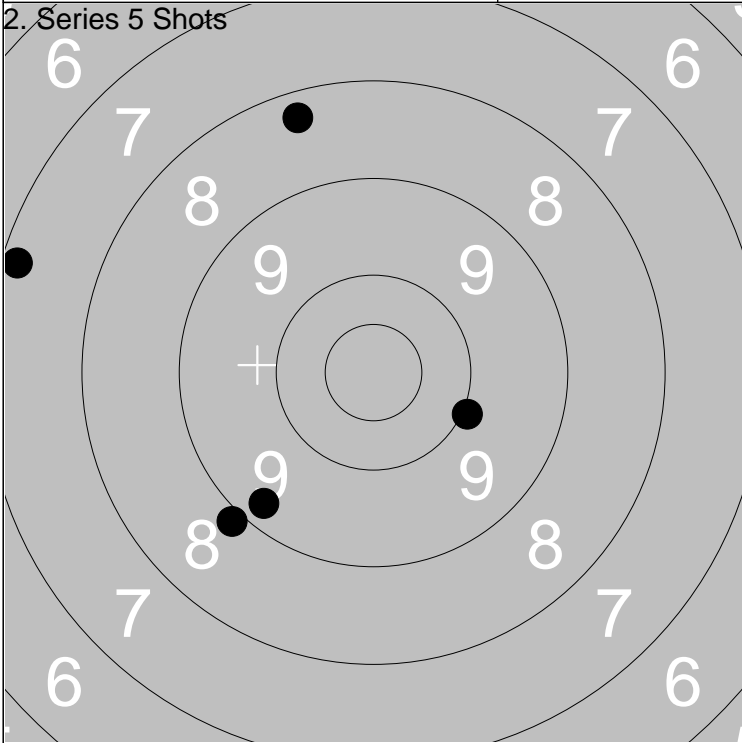

1: 8.3 ↑
2: 9.3 ↘
3: 7.2 ←
4: 10.0 →
5: 8.9 ↘

Series	42.0
Total	343.0

1: 7.8 ↘
2: 10.1 ↑
3: 6.5 →
4: 9.2 ↘
5: 10.2 ↘

Series	42.0
Total	385.0

Relay 5	Lane 24	Tony Jansson	
-------------------	-------------------	---------------------	--

300m	Ununge	B	St
------	--------	---	----

2013-07-08	Tavelträffen B 2013	Ramselefors SKF	
------------	---------------------	-----------------	--

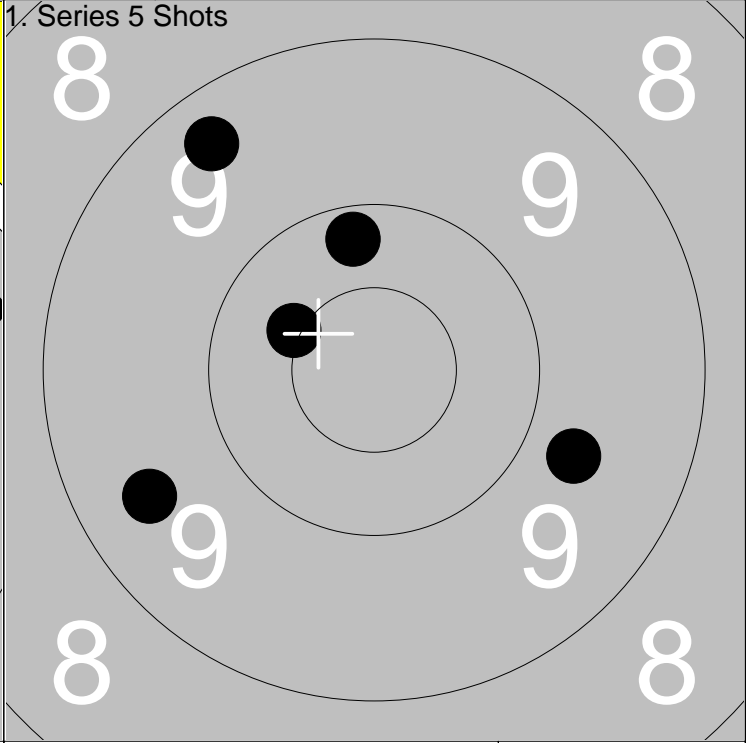
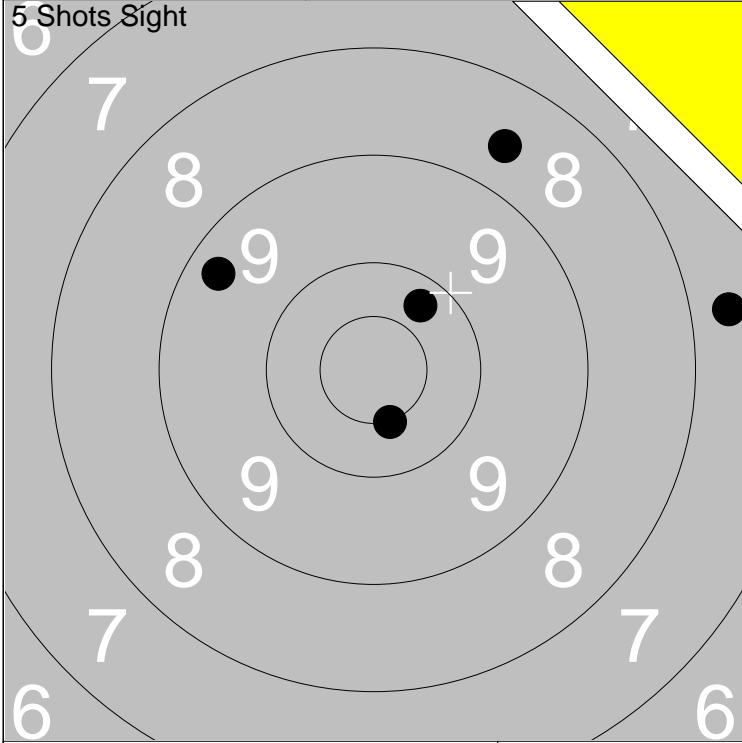

1: 9.3 ↖	Series	44.0
2: 10.3 ↗		
3: *10.5 ↓	Total	252.0
4: 8.6 ↗		
5: 7.7 →		

1: 9.3 ↖	Series	47.0
2: 10.2 ↑		
3: *10.4 ↖	Total	299.0
4: 9.5 ↖		
5: 9.7 ↘		

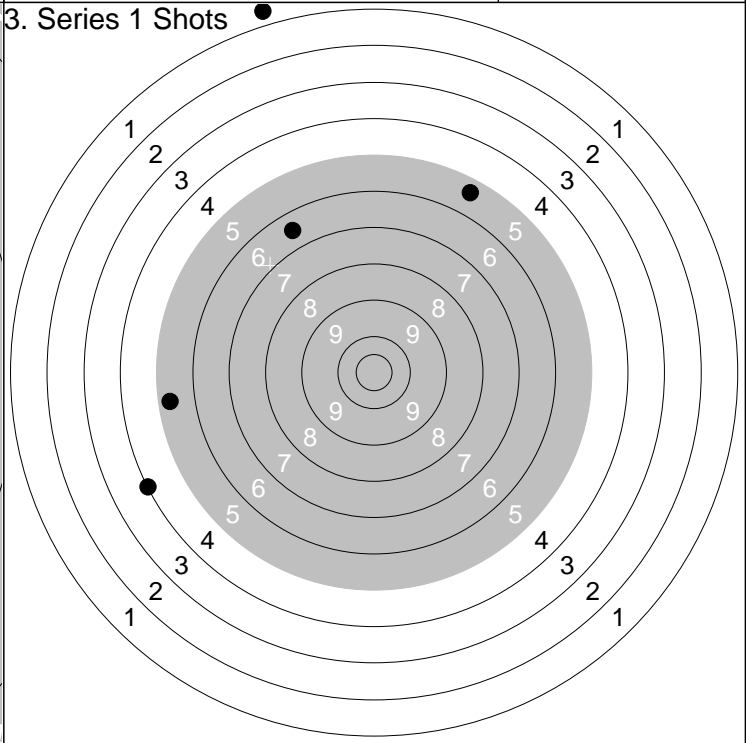
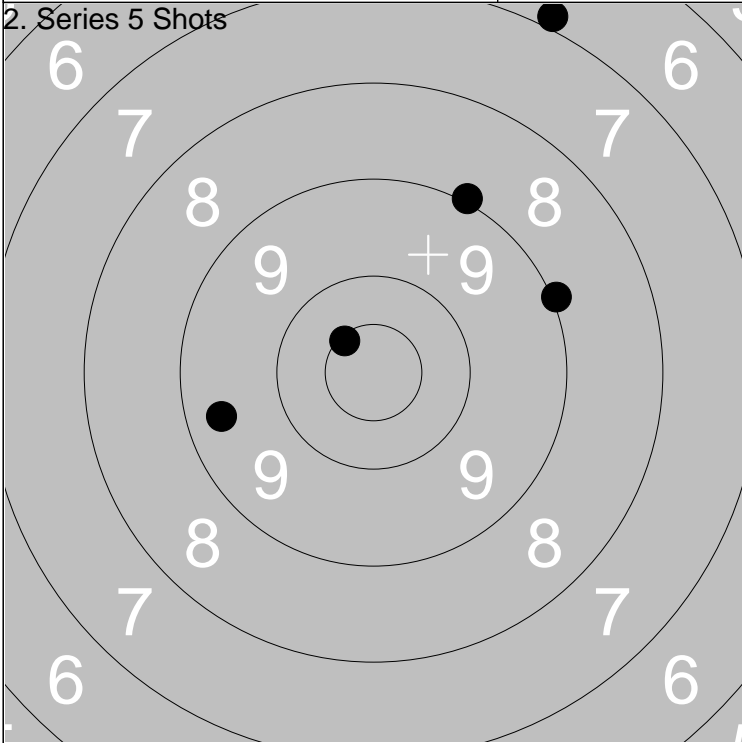

1: 6.9 ↗	Series	43.0
2: 9.4 ↖		
3: *10.5 ↖	Total	342.0
4: 9.0 →		
5: 9.0 ↗		

1: 5.4 ↗	Series	20.0
2: 6.5 ↖		
3: 0.0 ↗	Total	362.0
4: 5.4 ↖		
5: 4.1 ↖		

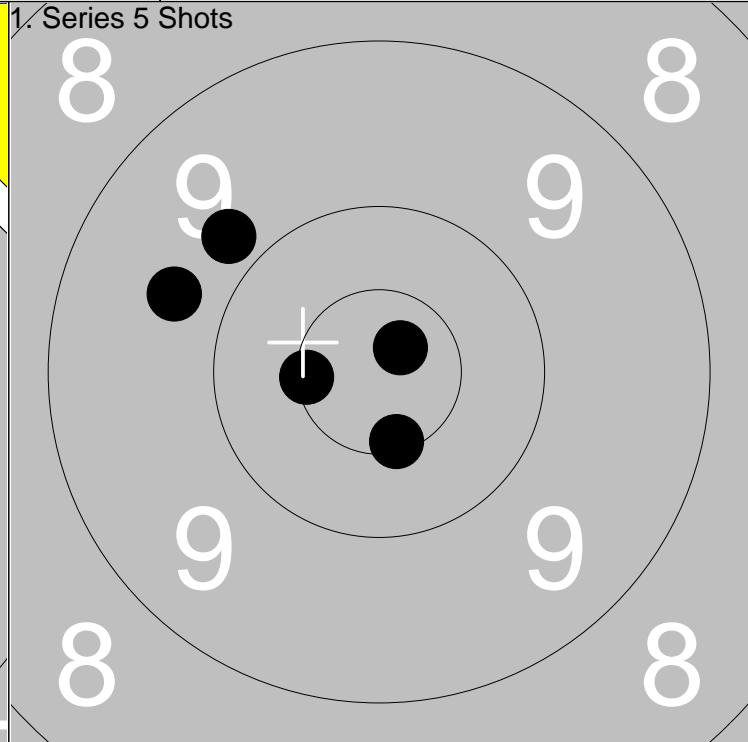
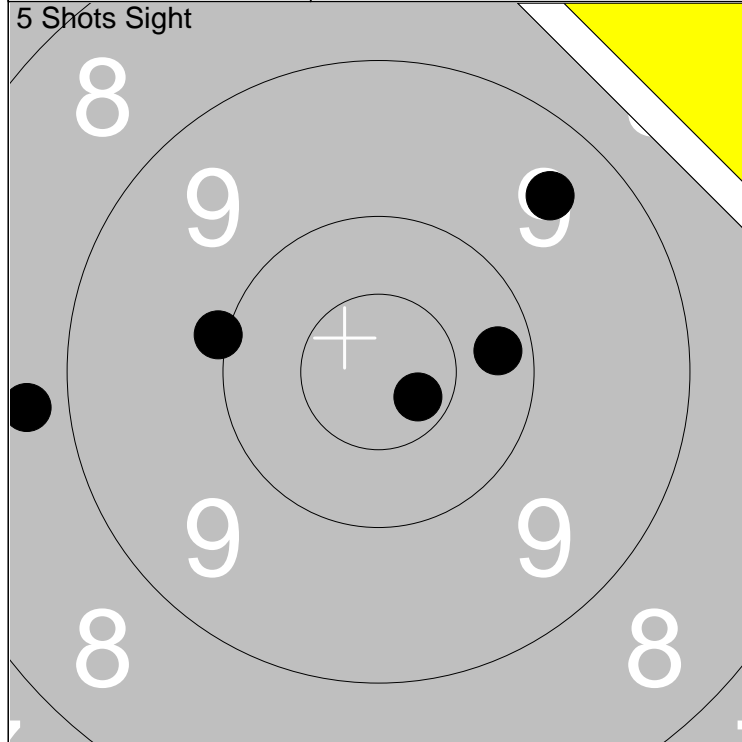

1: 9.5 ↗	Series	47.0
2: 10.2 →		
3: *10.7 ↘	Total	287.0
4: 8.8 ←		
5: 10.0 ←		

1: *10.5 ↓	Series	48.0
2: *10.8 ↗		
3: 9.8 ↖	Total	335.0
4: 9.7 ←		
5: *10.5 ←		

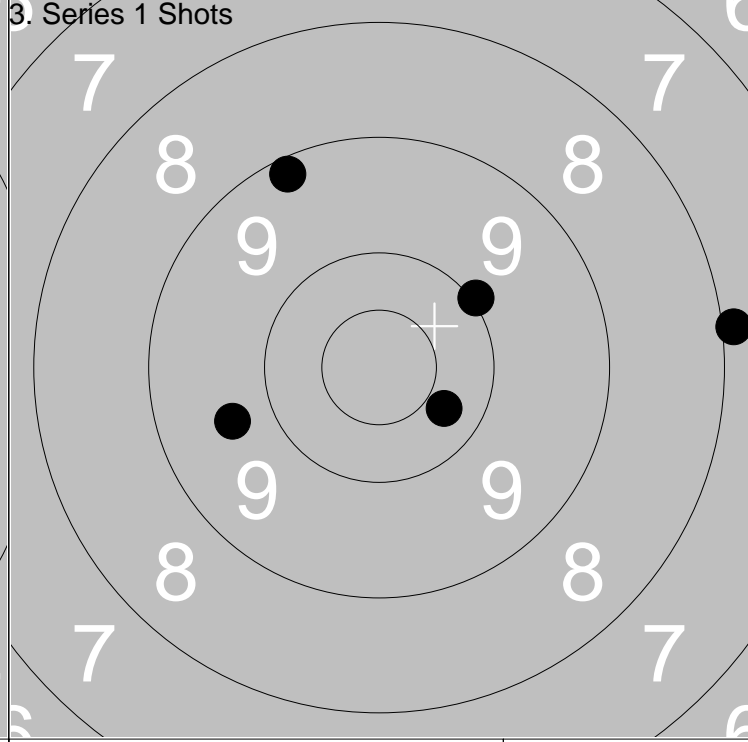
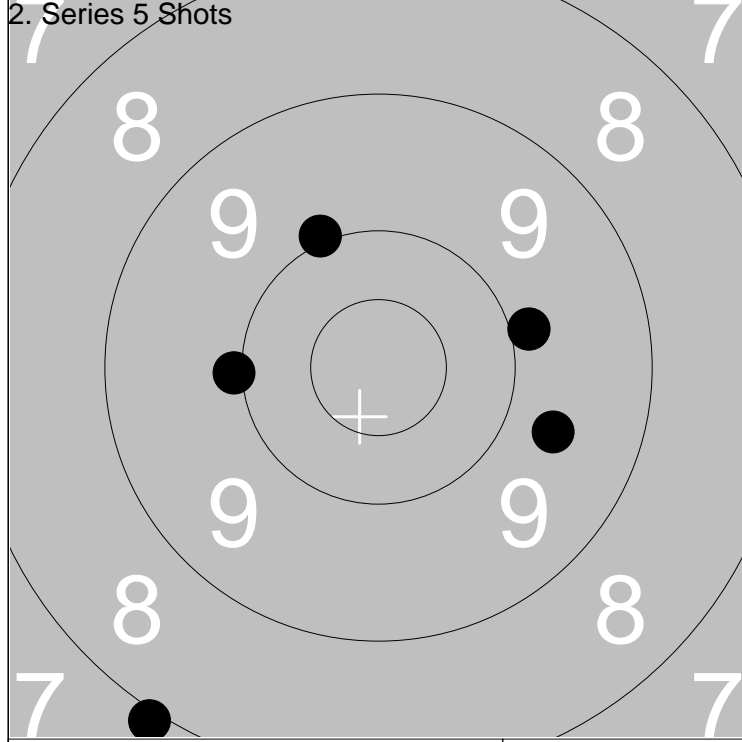

1: 10.0 ↖	Series	46.0
2: 9.9 →		
3: 10.0 ←	Total	381.0
4: 8.0 ↓		
5: 9.7 →		

1: 10.3 ↘	Series	45.0
2: 9.7 ←		
3: 7.9 →	Total	426.0
4: 9.2 ↖		
5: 10.0 ↗		

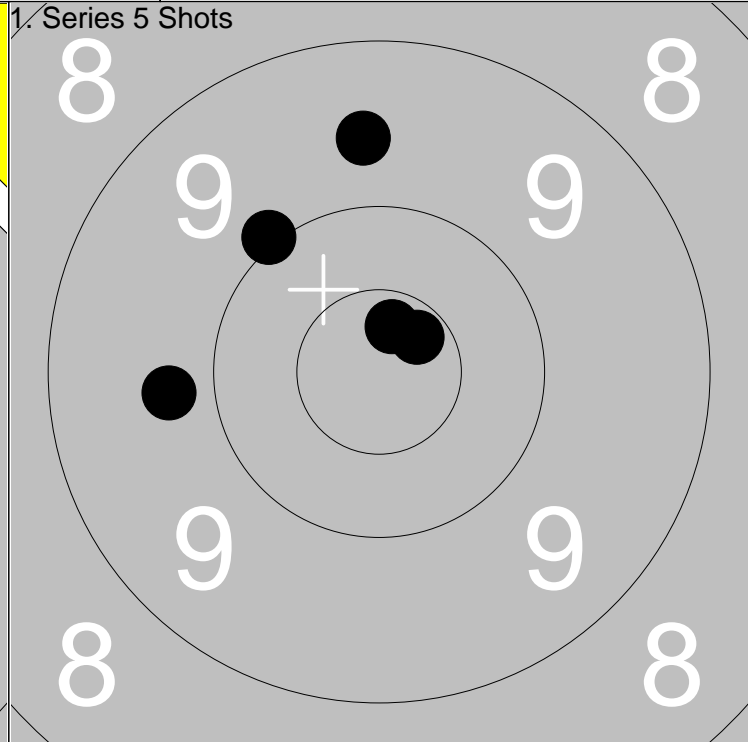
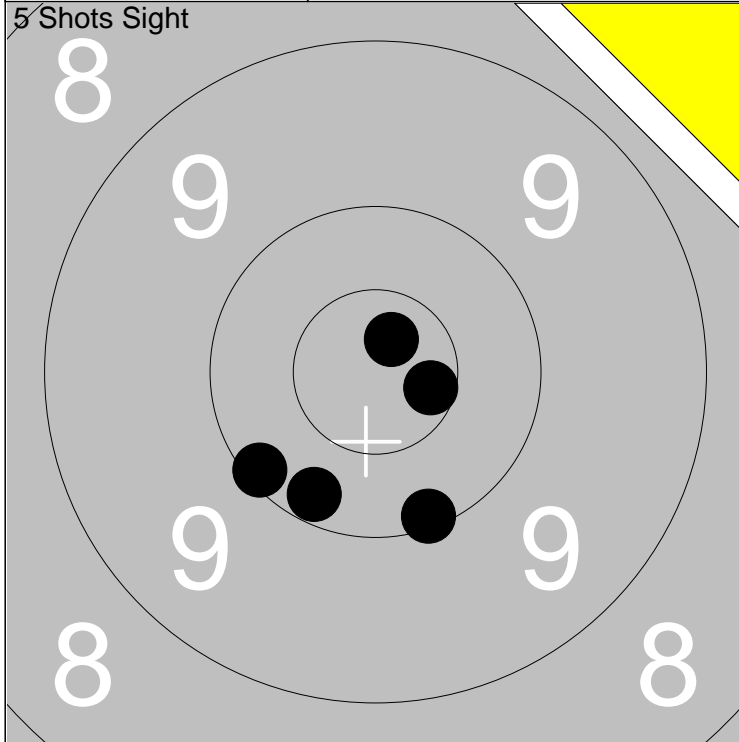

1: 10.2 ↘	Series 50.0
2: 10.1 ↘	
3: *10.6 →	
4: *10.7 ↗	
5: 10.1 ↘	
Total 287.0	

1: 9.8 ←	Series 48.0
2: *10.7 ↗	
3: 10.0 ↖	
4: *10.7 ↗	
5: 9.6 ↑	
Total 335.0	

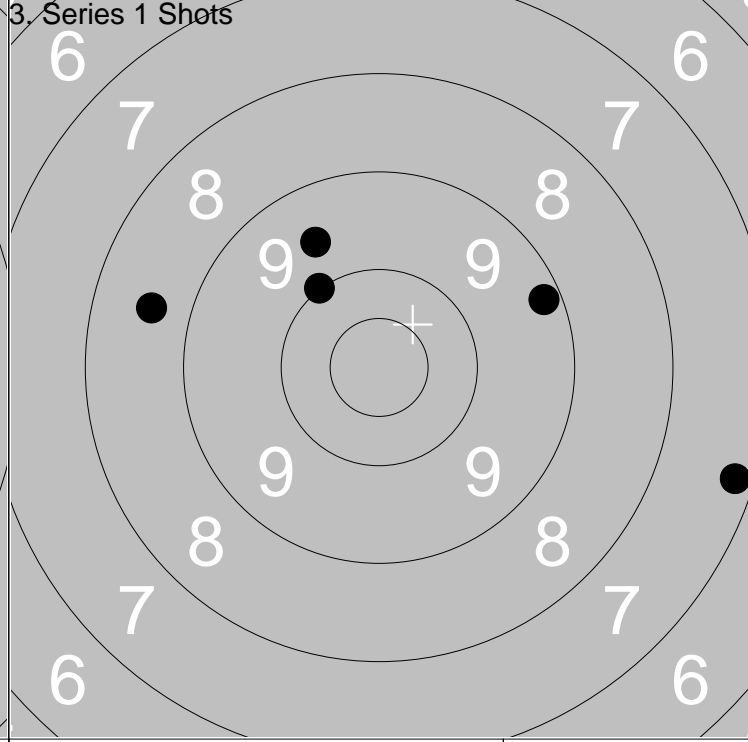
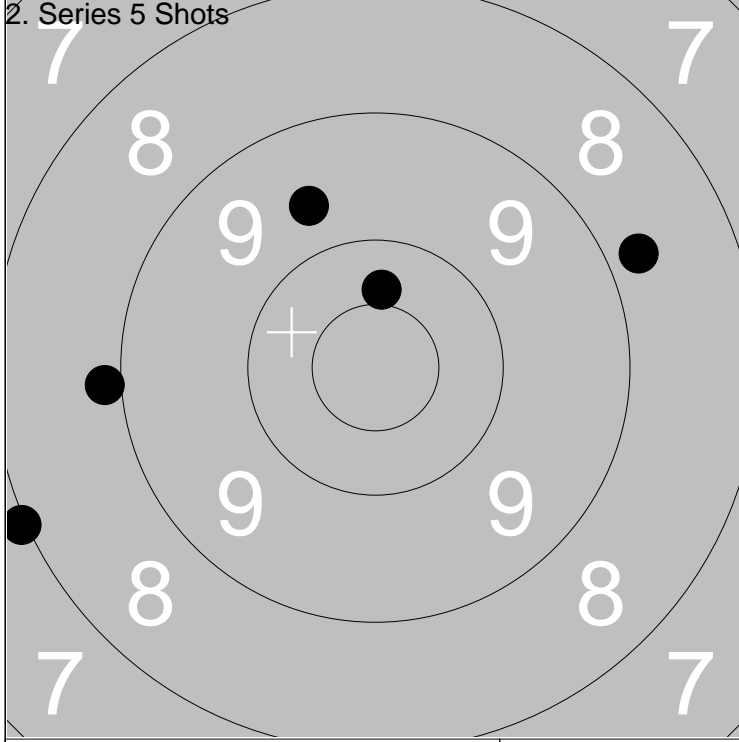

1: 9.7 ↗	Series 43.0
2: 8.9 ←	
3: 10.4 ↑	
4: 8.8 →	
5: 8.0 ←	
Total 378.0	

1: 9.2 →	Series 43.0
2: 7.2 →	
3: 8.6 ←	
4: 10.0 ↖	
5: 9.6 ↗	
Total 421.0	

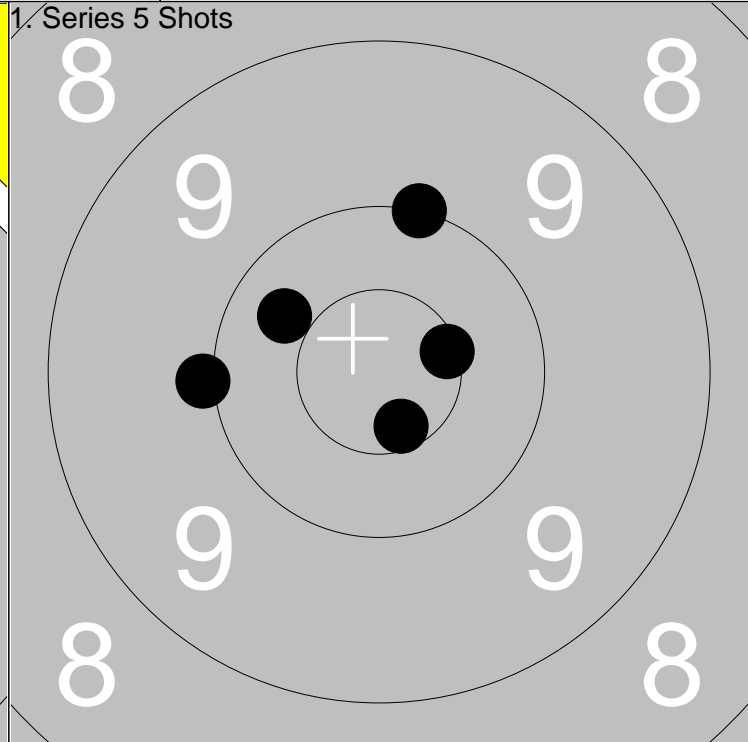
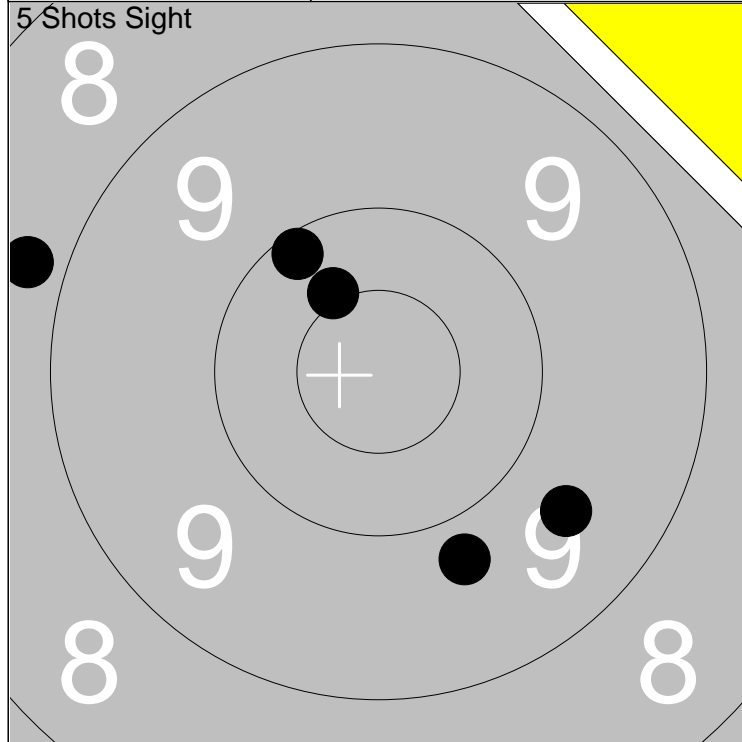

1: *10.4 ↗	Series	46.0
2: 9.6 ↘		
3: 9.8 ↘	Total	285.0
4: 8.8 ↖		
5: 10.1 ↗		

1: *10.6 ↘	Series	50.0
2: 10.0 ↗		
3: 10.3 ↖	Total	335.0
4: *10.6 →		
5: 10.0 ←		

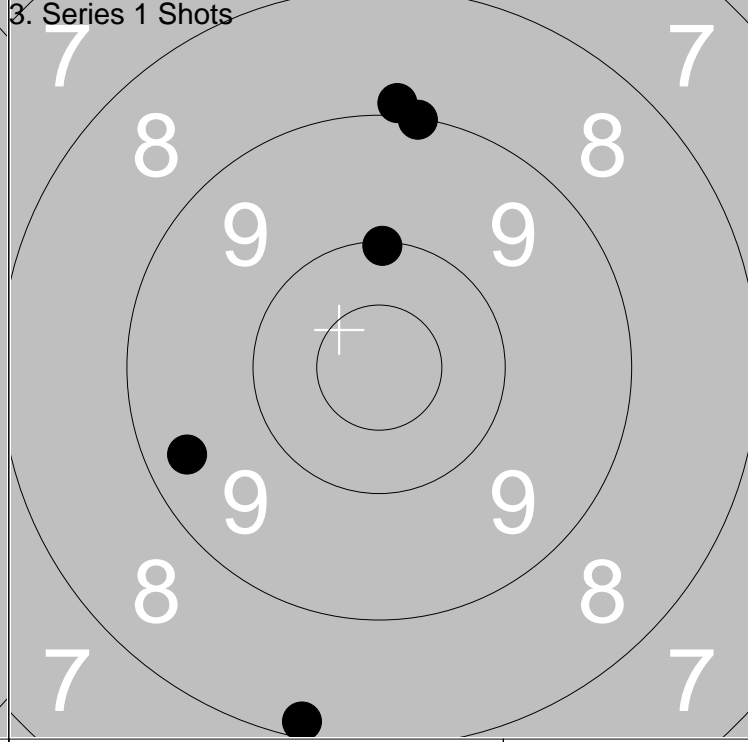
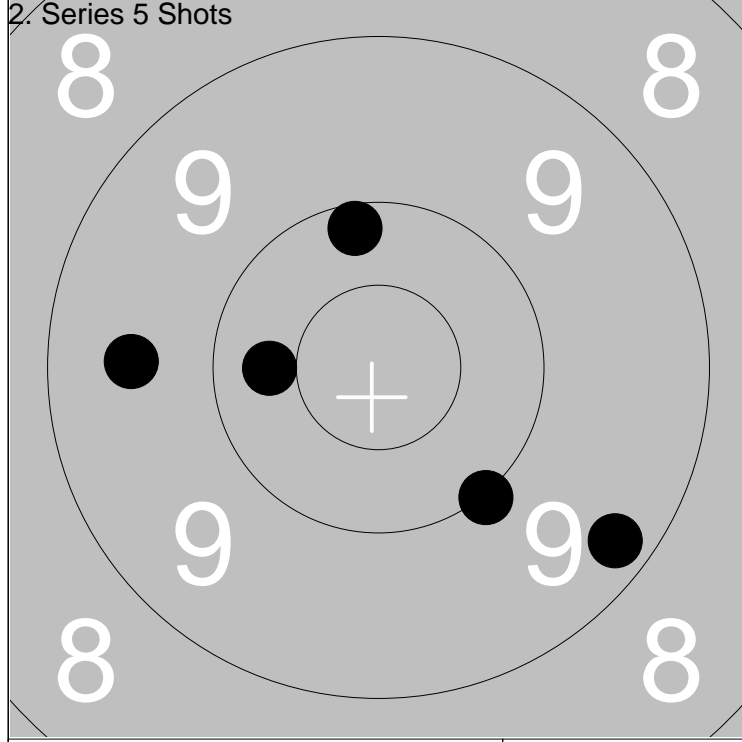

1: 9.5 ←	Series	48.0
2: 10.0 ↘		
3: 10.3 ←	Total	383.0
4: 10.2 ↗		
5: 9.3 ↘		

1: 9.4 ↖	Series	44.0
2: 8.9 ↗		
3: 10.1 ↗	Total	427.0
4: 8.2 ↘		
5: 9.0 ↗		

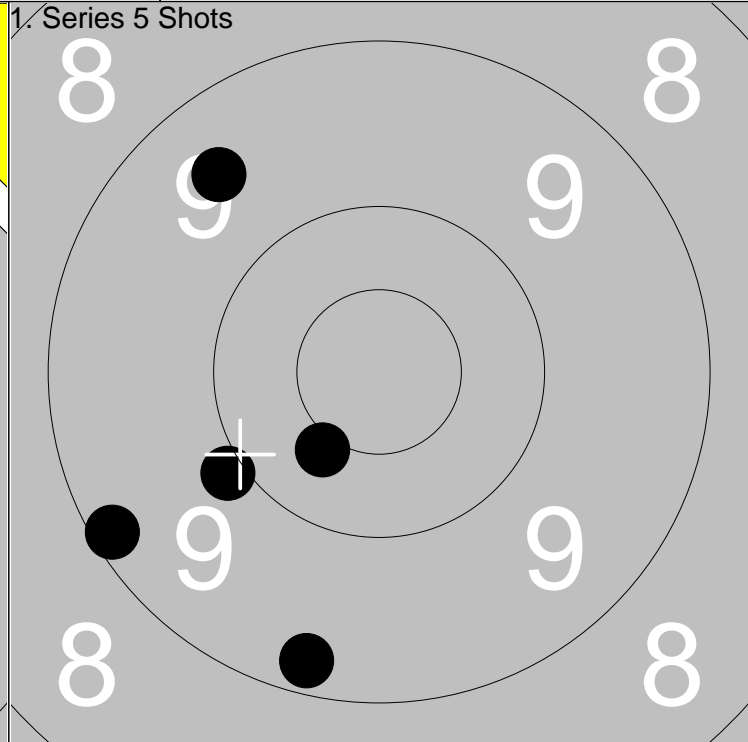
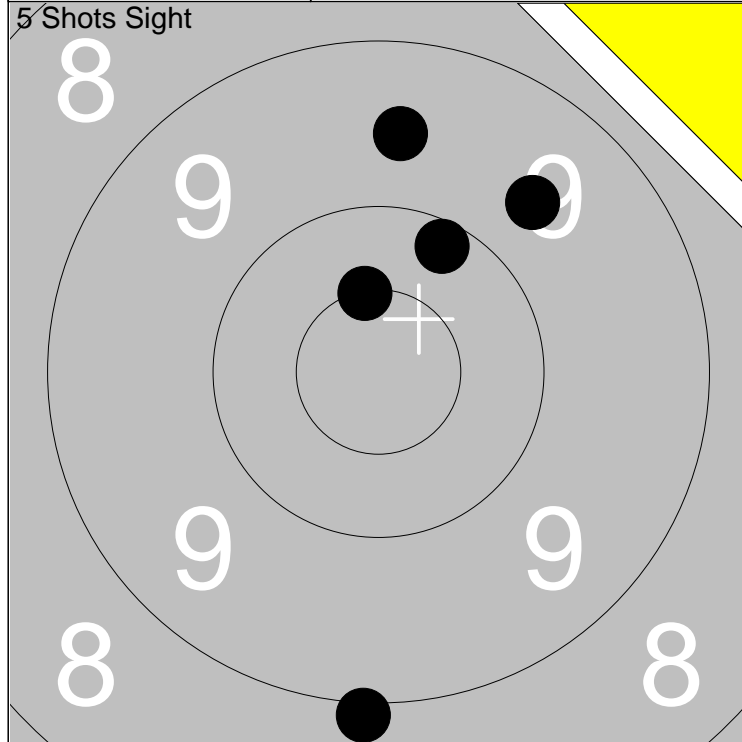

1: 9.0 ↓	Series	47.0
2: 9.6 ↗		
3: 9.6 ↑	Total	283.0
4: *10.5 ↑		
5: 10.2 ↗		

1: 9.5 ↖	Series	46.0
2: 9.2 ↓		
3: 9.2 ↙	Total	329.0
4: 9.9 ↙		
5: 10.4 ↙		

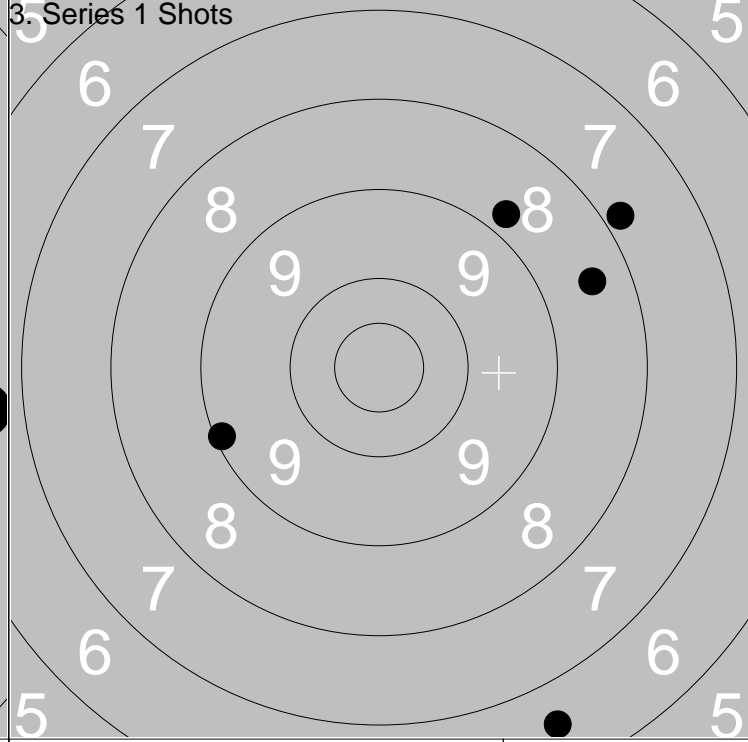
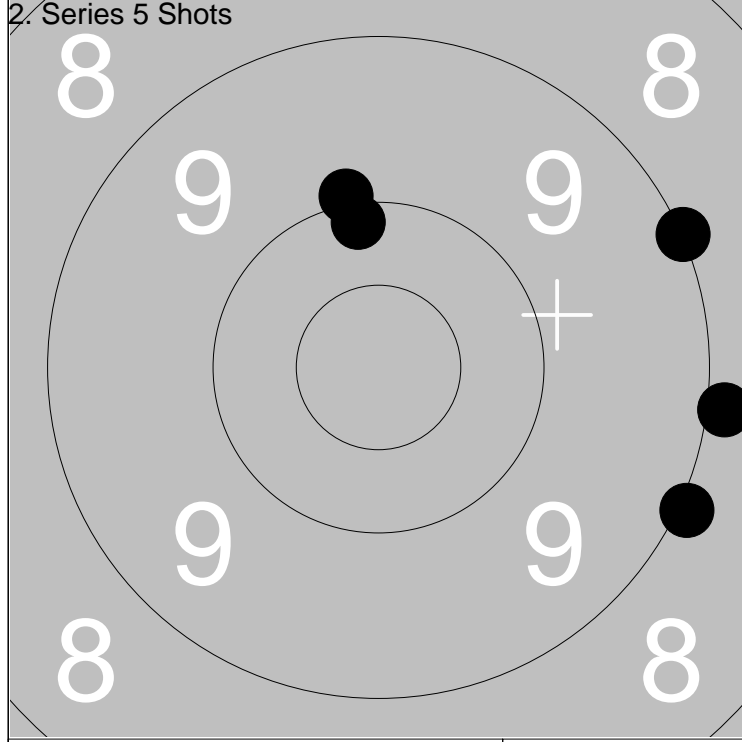

1: 9.0 ➔	Series	46.0
2: 10.1 ↑		
3: 10.0 ↑	Total	375.0
4: 8.9 ➔		
5: 9.0 ➔		

1: 9.1 ↙	Series	38.0
2: 8.8 ↗		
3: 7.8 ↗	Total	413.0
4: 6.6 ↓		
5: 8.5 ➔		

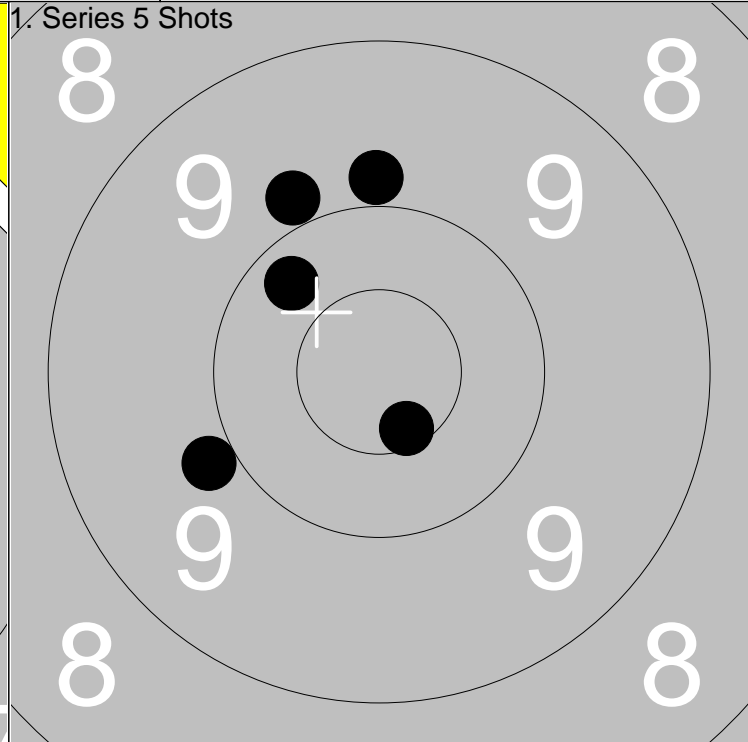
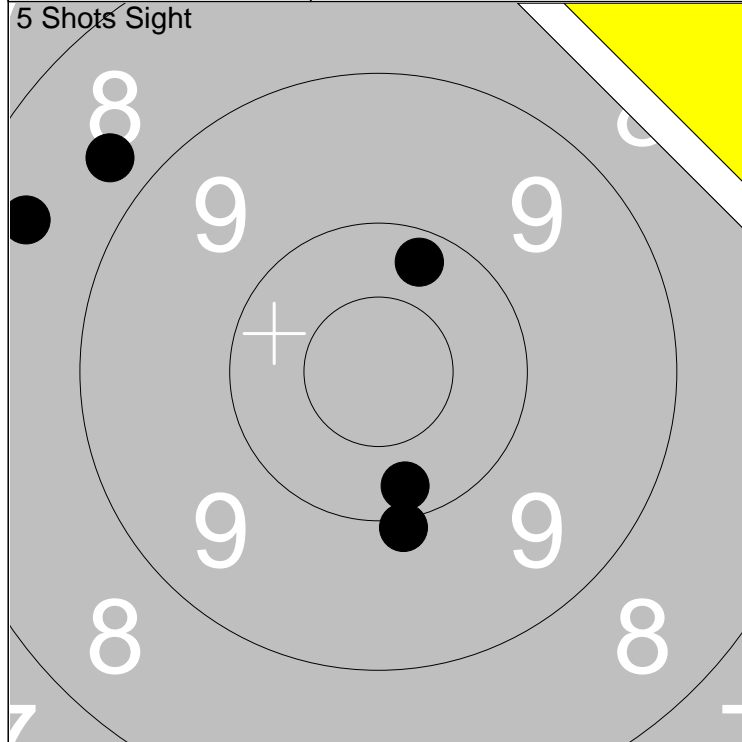

1: 10.2 ↓	Series 46.0
2: 10.2 ↑	
3: 10.0 ↓	
4: 8.5 ↖	
5: 8.7 ↖	
Total 281.0	

1: 9.9 ↑	Series 47.0
2: 10.3 ↖	
3: 9.9 ↙	
4: 9.9 ↑	
5: *10.6 ↓	
Total 328.0	

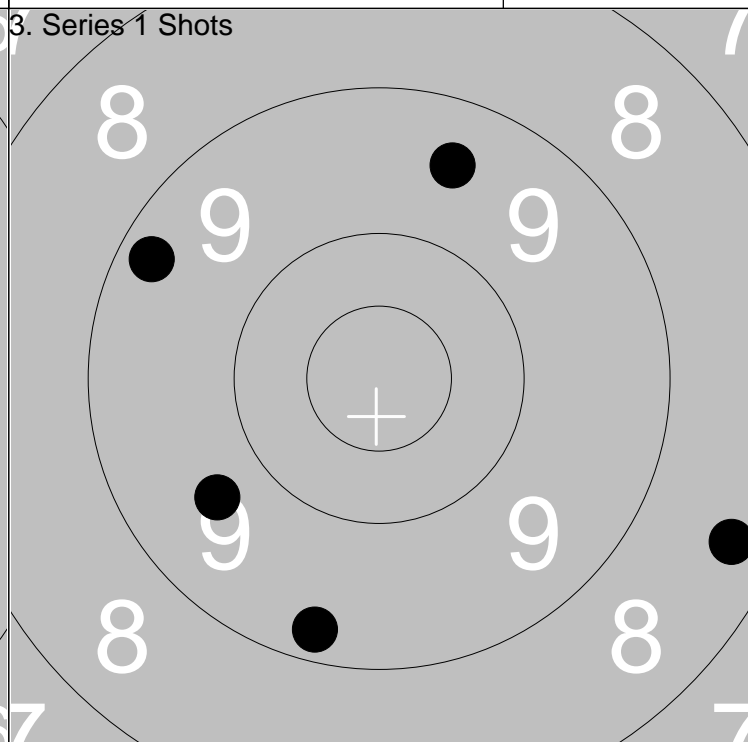
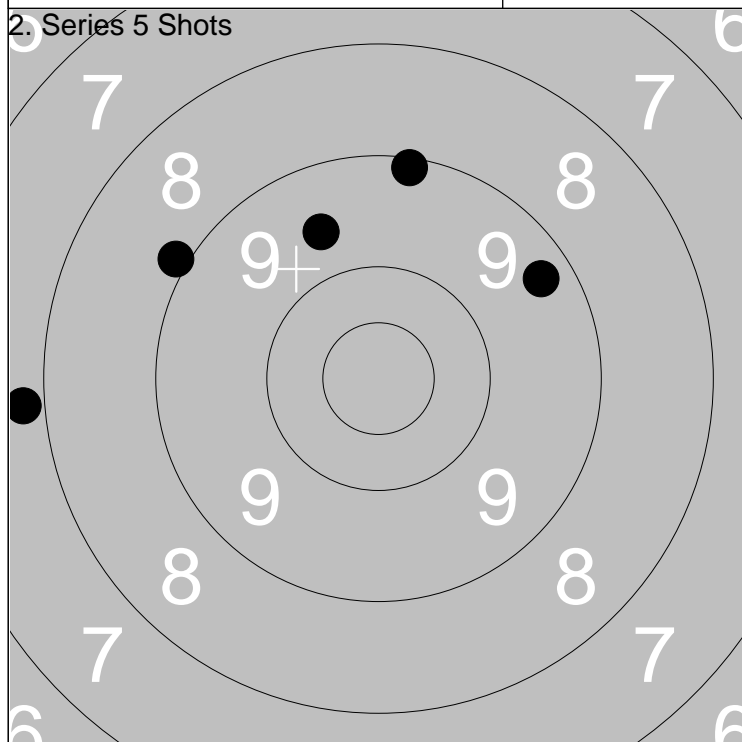

1: 7.8 ↖	Series 42.0
2: 9.6 ↑	
3: 9.1 ↑	
4: 8.9 ↖	
5: 9.3 ↗	
Total 370.0	

1: 9.5 ↑	Series 44.0
2: 8.4 →	
3: 9.7 ↙	
4: 9.2 ↓	
5: 9.3 ↖	
Total 414.0	

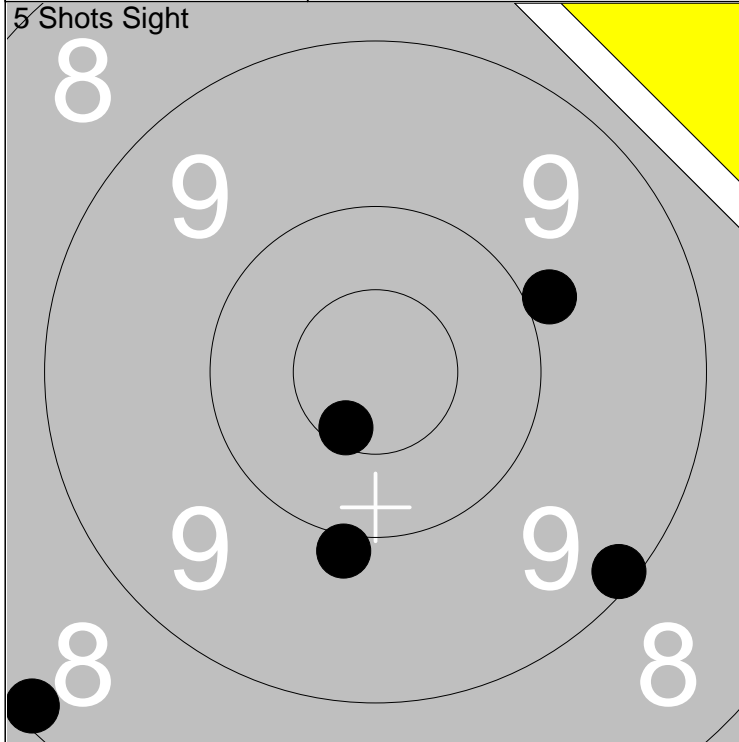

1: 9.1 ↘	Series	45.0
2: 9.9 →		
3: 9.9 ↓	Total	281.0
4: 8.1 ↙		
5: *10.6 ↘		

1: 9.5 ↖	Series	48.0
2: 9.1 ↑		
3: *10.8 ↗	Total	329.0
4: 10.4 ↖		
5: *10.5 ↘		

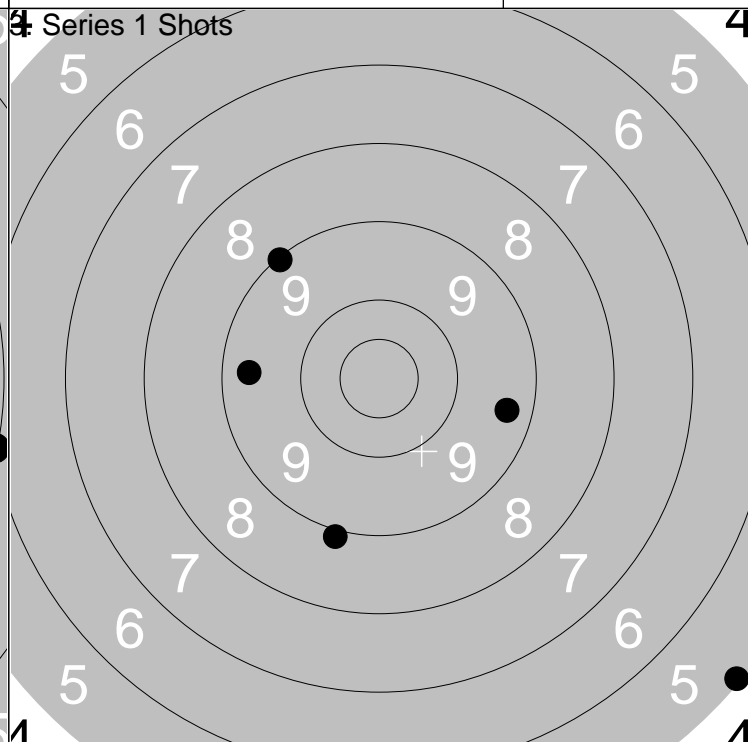
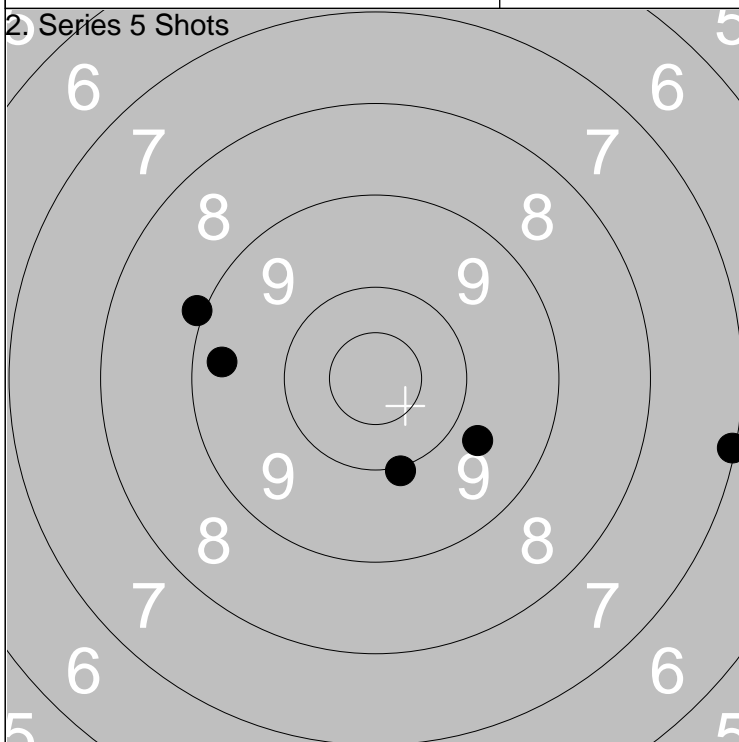

1: 9.0 ↖	Series	44.0
2: 10.0 ↘		
3: 9.3 ↖	Total	373.0
4: 7.1 →		
5: 9.7 ↘		

1: 9.1 ↗	Series	40.0
2: 9.4 →		
3: 8.9 ↓	Total	413.0
4: 9.4 ↖		
5: 5.1 ↘		

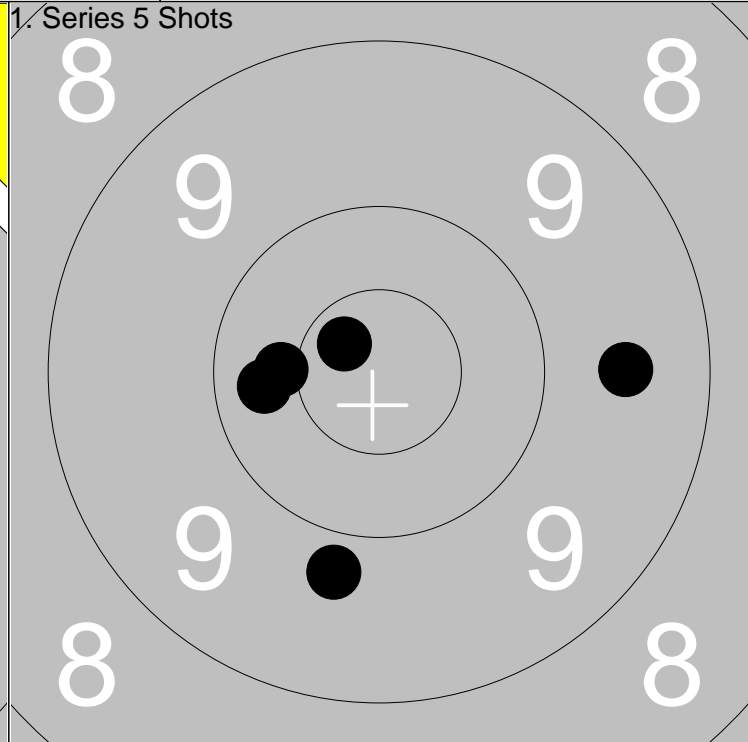
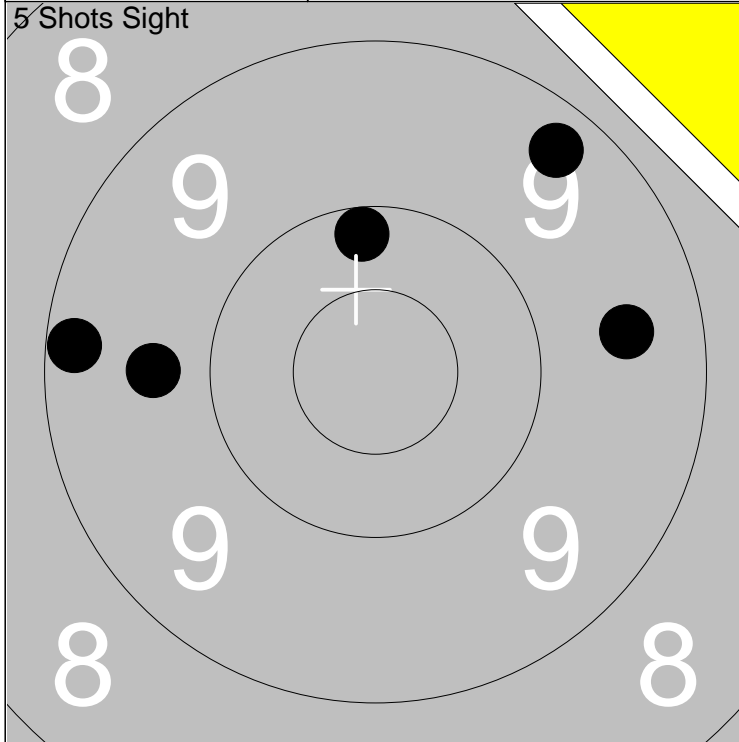

1: 9.3 ↗
2: 9.5 →
3: 10.2 ↑
4: 9.7 ←
5: 9.2 ←

Series	46.0
Total	279.0

1: 10.4 ←
2: *10.7 ↖
3: 9.5 →
4: 10.3 ←
5: 9.8 ↓

Series	48.0
Total	327.0

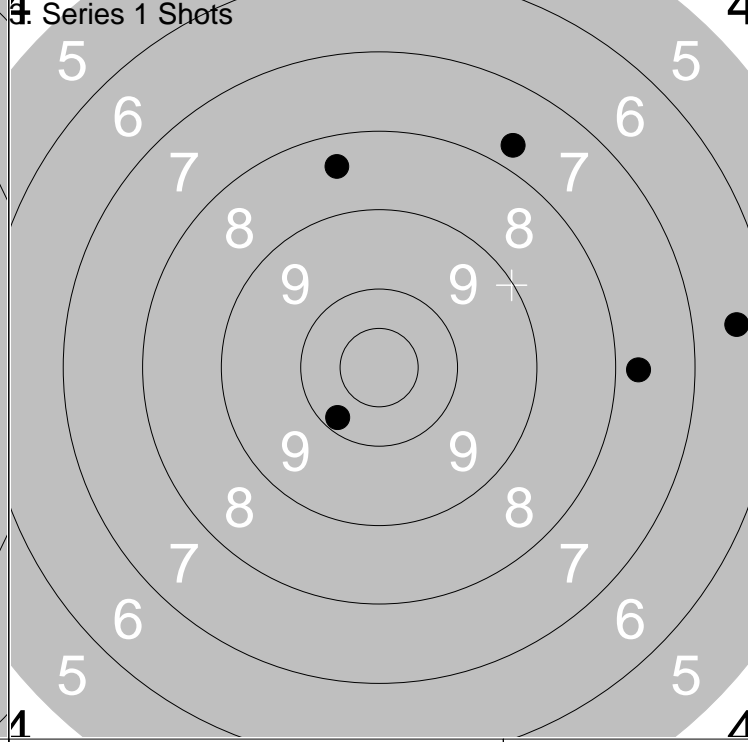
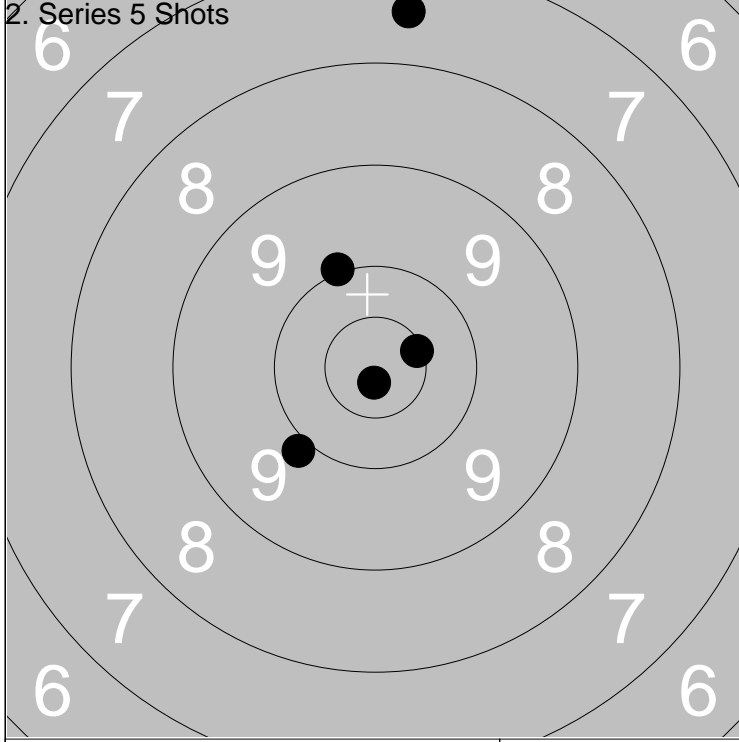

1: 7.5 ↑
2: *10.5 →
3: 10.0 ↖
4: *10.8 ↓
5: 9.9 ↙

Series	46.0
Total	373.0

1: 8.4 ↑
2: 7.7 ↗
3: 6.5 →
4: 10.2 ↙
5: 7.7 →

Series	38.0
Total	411.0

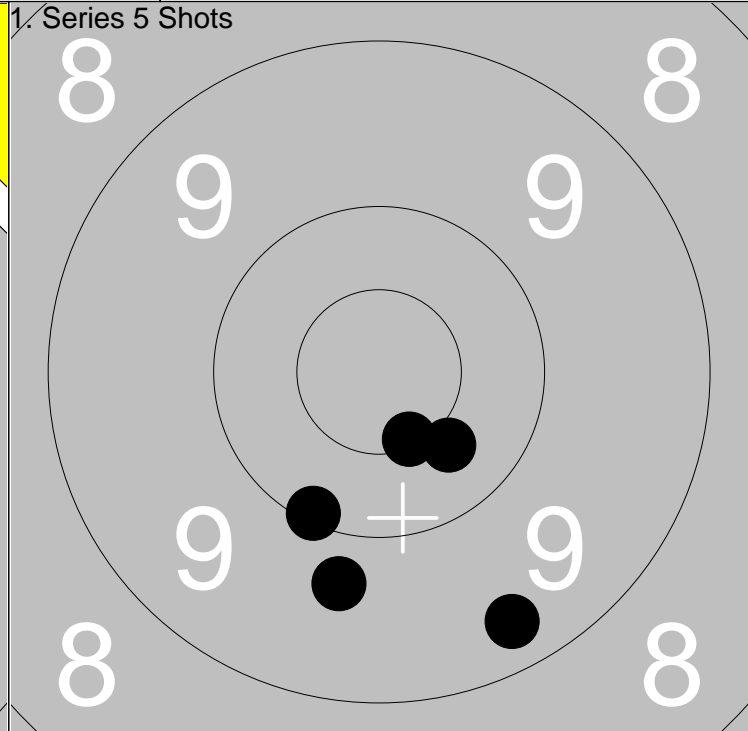
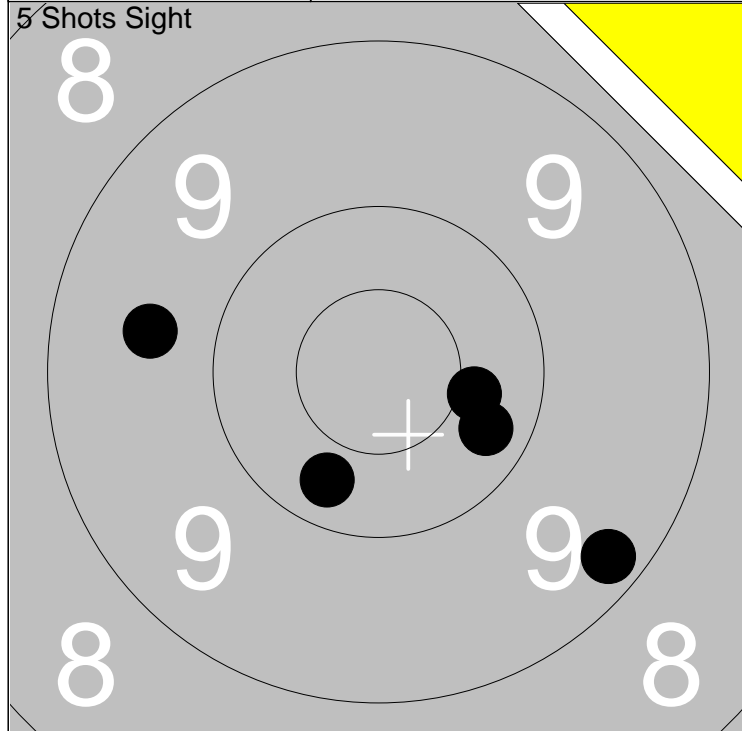

1: 9.2 ↘	Series	48.0
2: 10.3 ↘		
3: 10.4 →	Total	277.0
4: 9.6 ←		
5: 10.3 ↙		

1: *10.5 ↘	Series	48.0
2: 9.7 ↘		
3: 9.3 ↘	Total	325.0
4: 10.1 ↘		
5: 10.4 ↘		

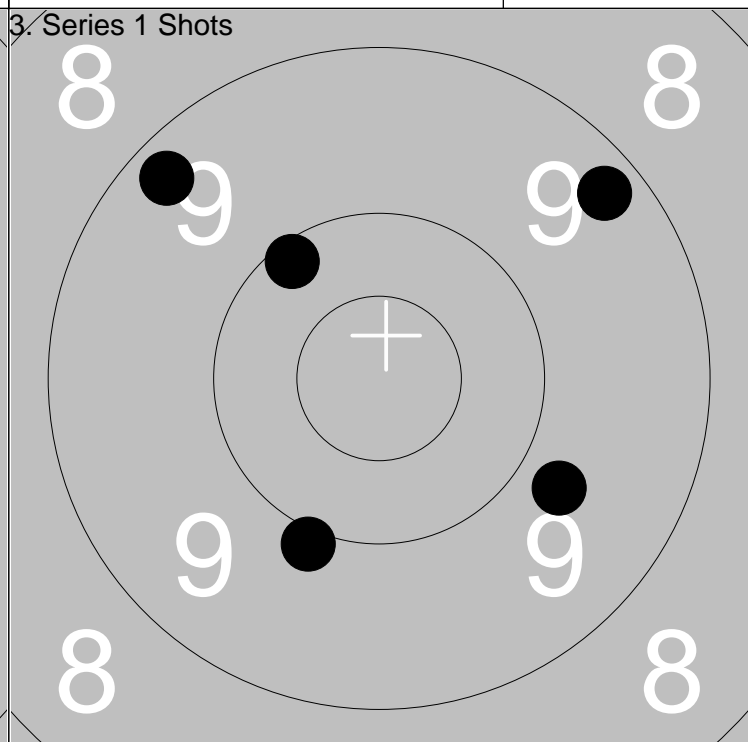
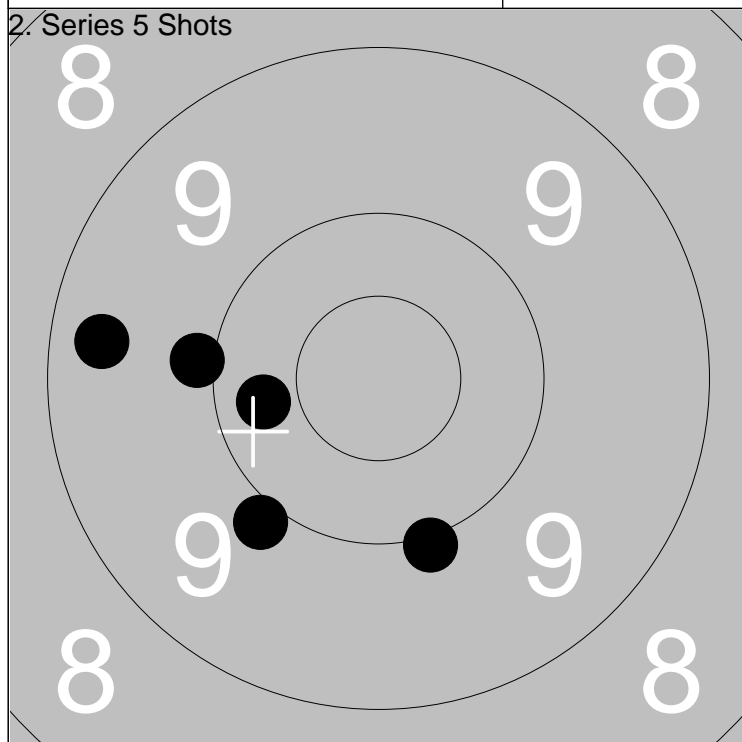

1: 9.9 ←	Series	47.0
2: 9.9 ↙		
3: 9.3 ←	Total	372.0
4: 10.3 ←		
5: 10.0 ↙		

1: 9.9 ↙	Series	46.0
2: 9.8 →		
3: 9.3 ↗	Total	418.0
4: 10.1 ↖		
5: 9.3 ↖		

Relay 6	Lane 9	Martin Nilsson
-------------------	------------------	-----------------------

300m	Kvistbro	A	Ör
------	----------	---	----

2013-07-08	Tavelträffen B 2013	Ramselefors SKF
------------	---------------------	-----------------

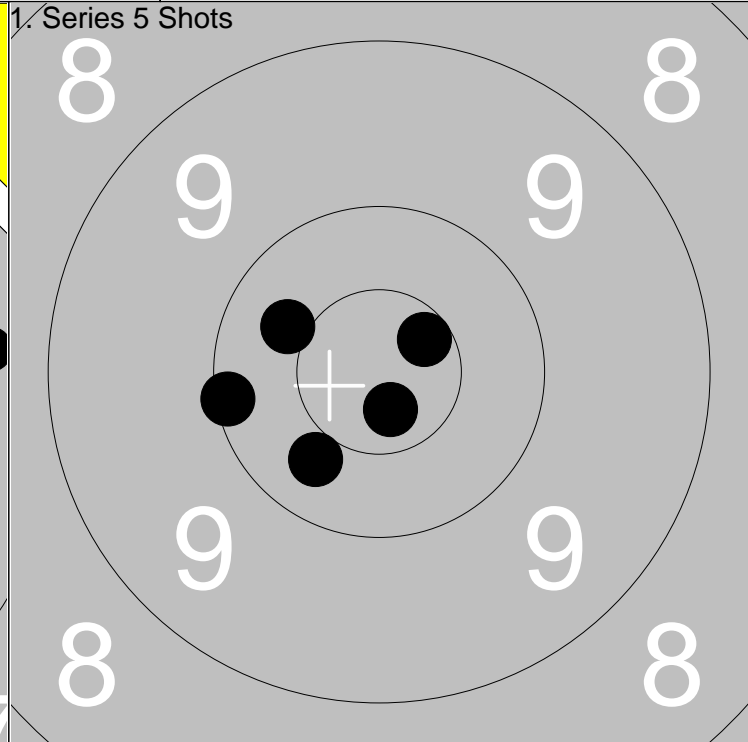
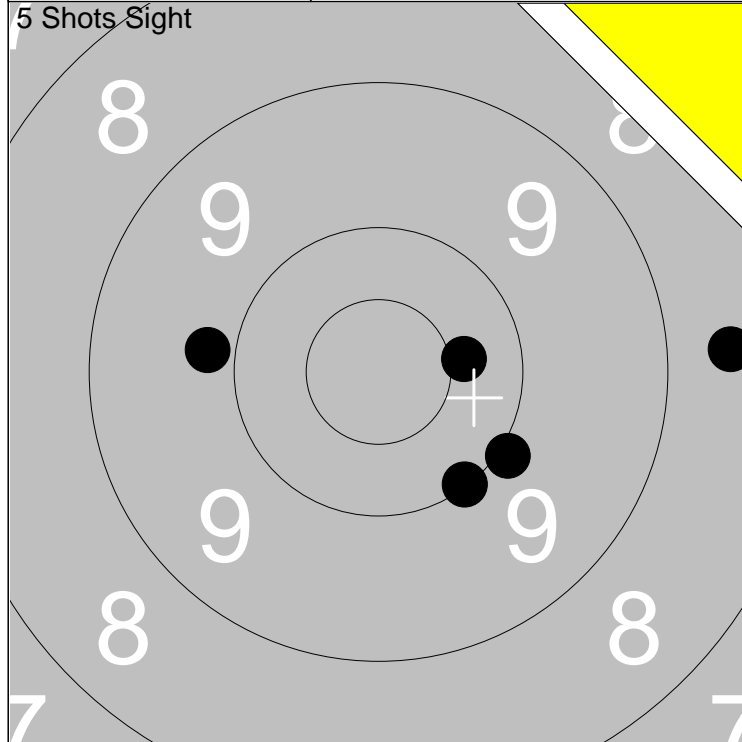

1: 10.4 →
2: 10.0 ↘
3: 10.0 ↘
4: 9.8 ←
5: 8.6 →

Series	47.0
Total	276.0

1: 10.1 ←
2: 10.3 ↘
3: 10.4 ↖
4: *10.6 ↗
5: *10.7 ↘

Series	50.0
Total	326.0

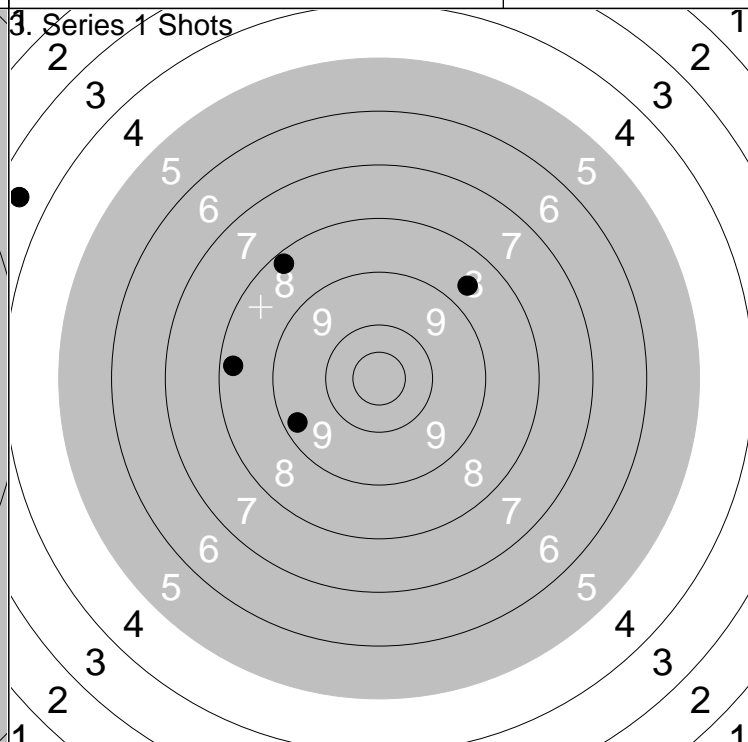
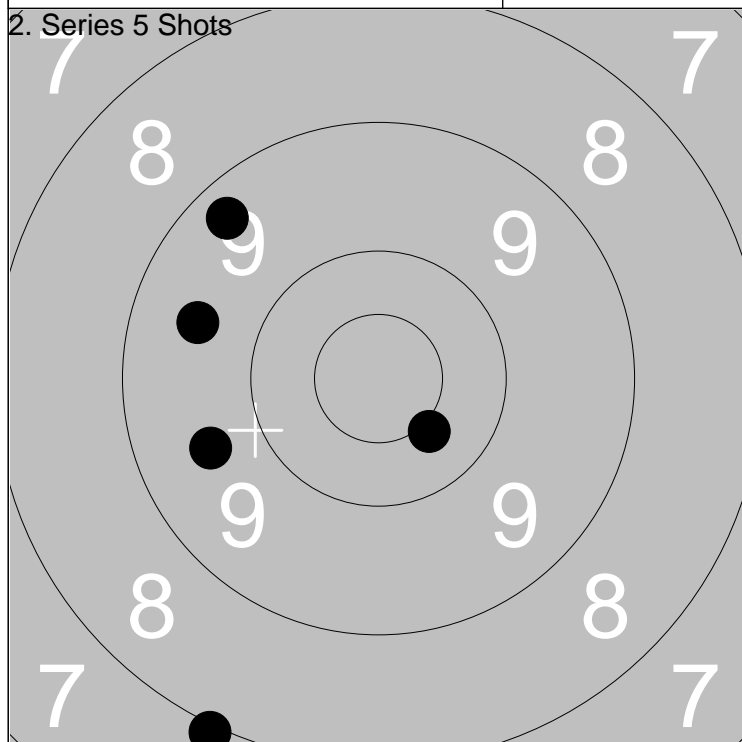

1: 9.6 ←
2: 9.3 ↗
3: 8.0 ↘
4: *10.4 ↘
5: 9.6 ←

Series	45.0
Total	371.0

1: 3.5 ←
2: 8.6 ↗
3: 9.3 ←
4: 8.3 ←
5: 8.2 ↗

Series	36.0
Total	407.0

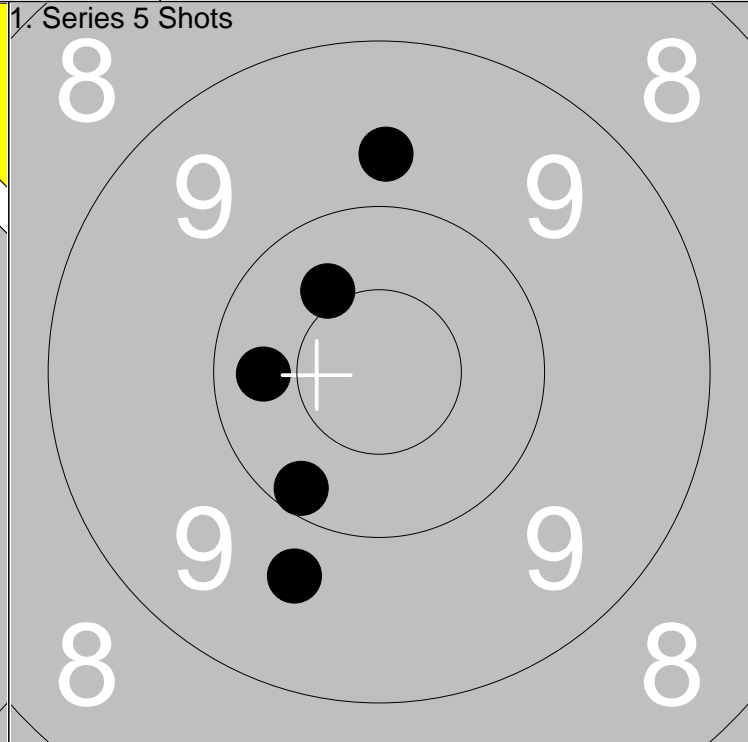
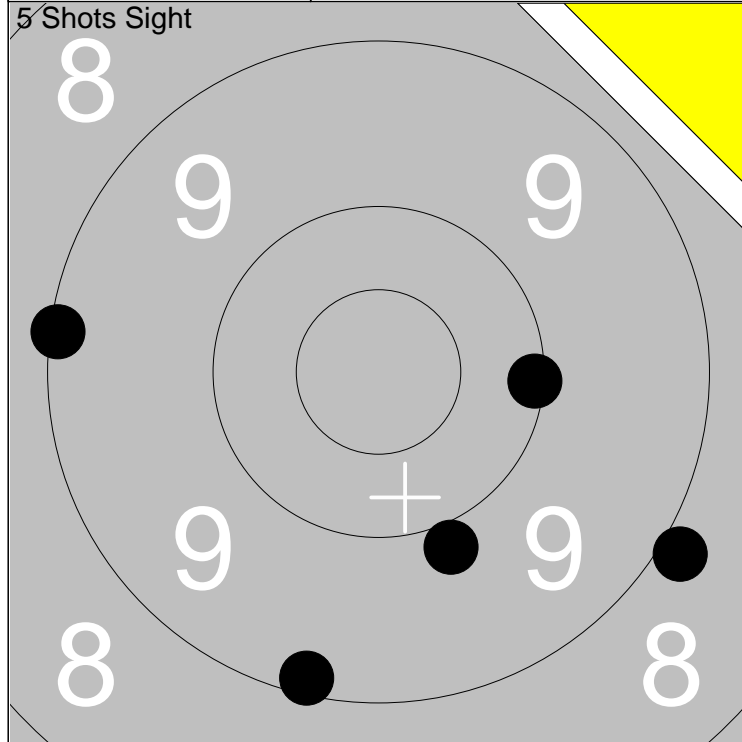

1: 8.9 ↘	Series	45.0
2: 10.1 →		
3: 9.9 ↘	Total	276.0
4: 9.1 ↘		
5: 9.1 ←		

1: 9.7 ↑	Series	48.0
2: 10.3 ←		
3: *10.4 ↖	Total	324.0
4: 9.7 ↘		
5: 10.2 ↘		

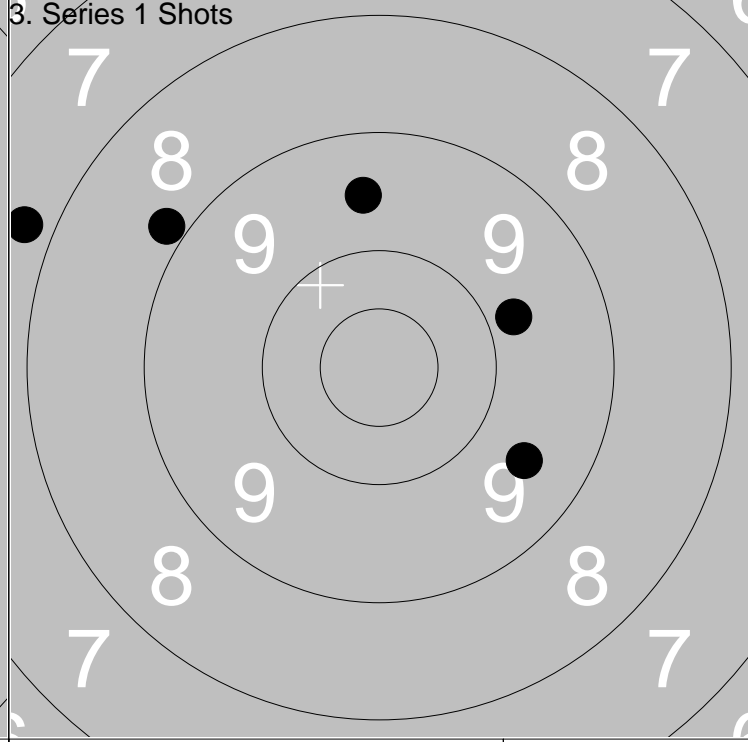
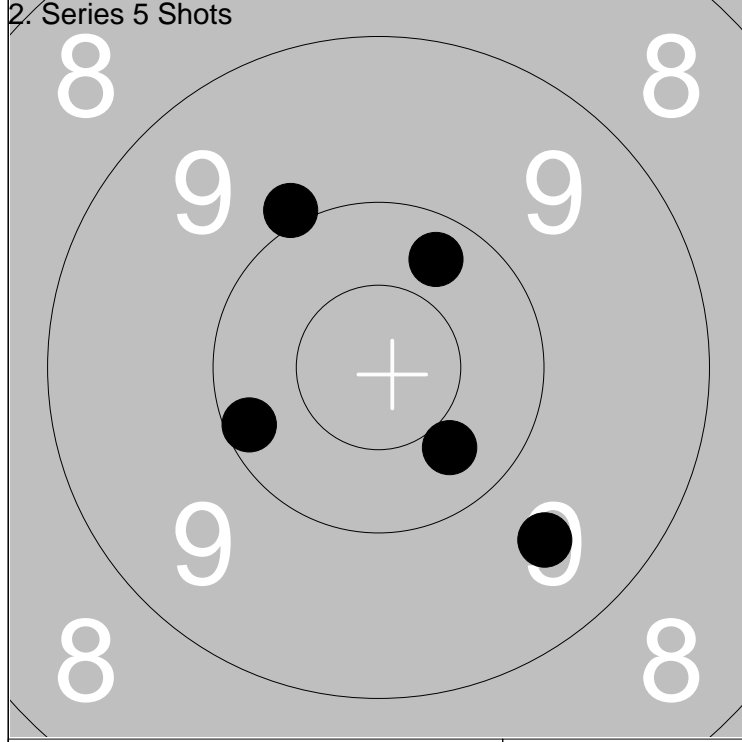

1: 9.6 ↘	Series	48.0
2: 10.2 ↖		
3: 10.3 ↗	Total	372.0
4: 9.9 ↗		
5: 10.3 ↘		

1: 8.9 ↖	Series	42.0
2: 9.6 ↑		
3: 7.8 ↖	Total	414.0
4: 9.6 ↘		
5: 9.8 →		

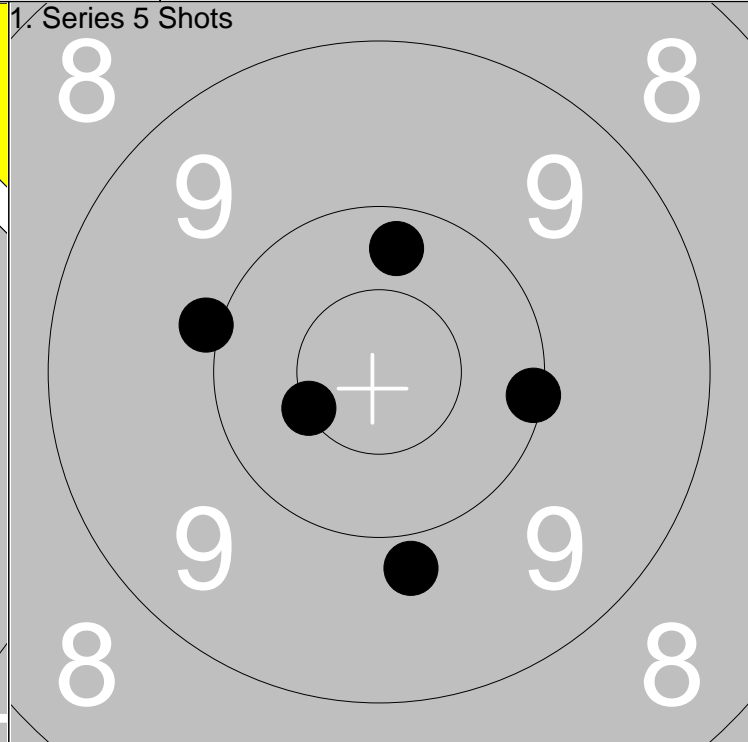
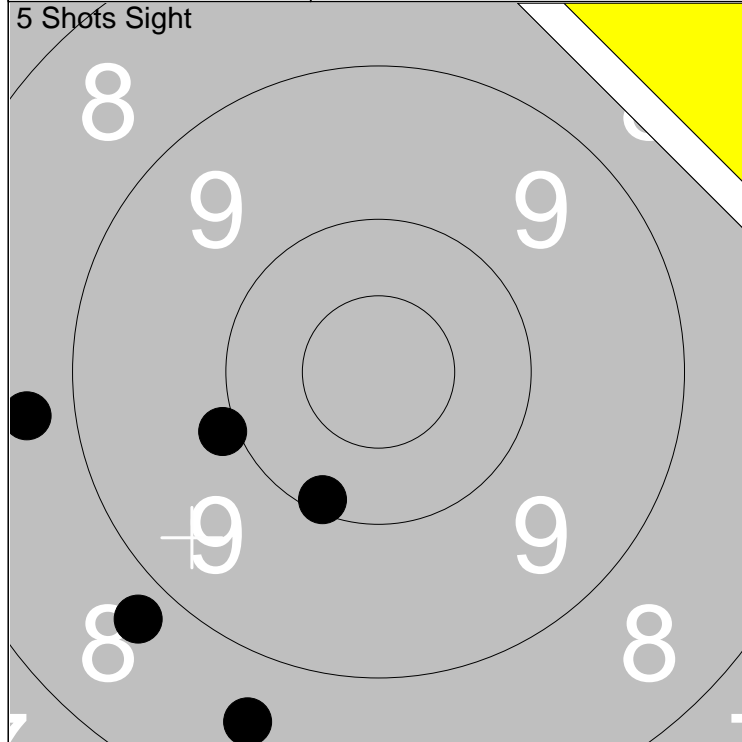

1: 10.1 ↘	Series	43.0
2: 8.6 ↘		
3: 8.8 ↘	Total	275.0
4: 9.9 ←		
5: 8.7 ←		

1: 9.9 ←	Series	48.0
2: 9.8 ↘		
3: 10.1 →	Total	323.0
4: 10.3 ↑		
5: *10.5 ↙		

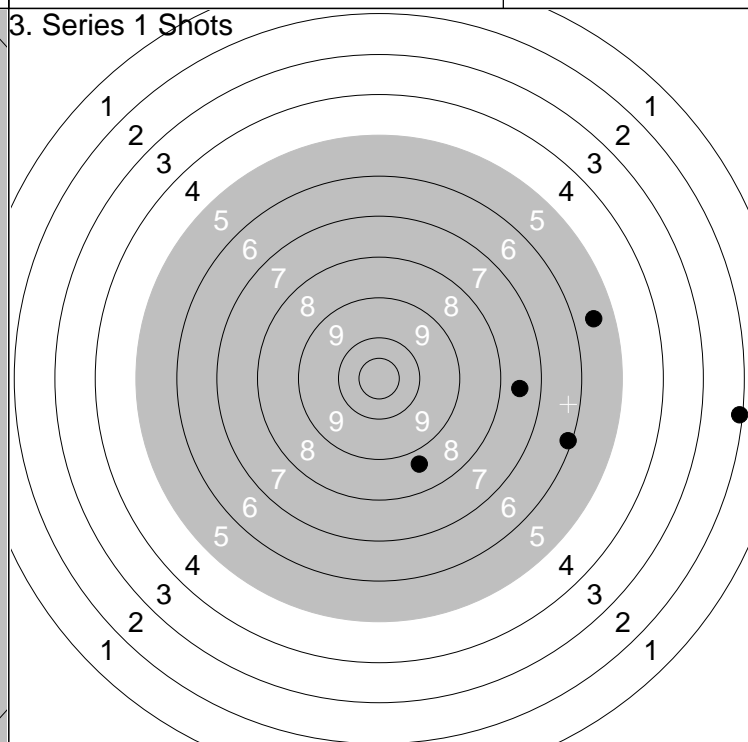
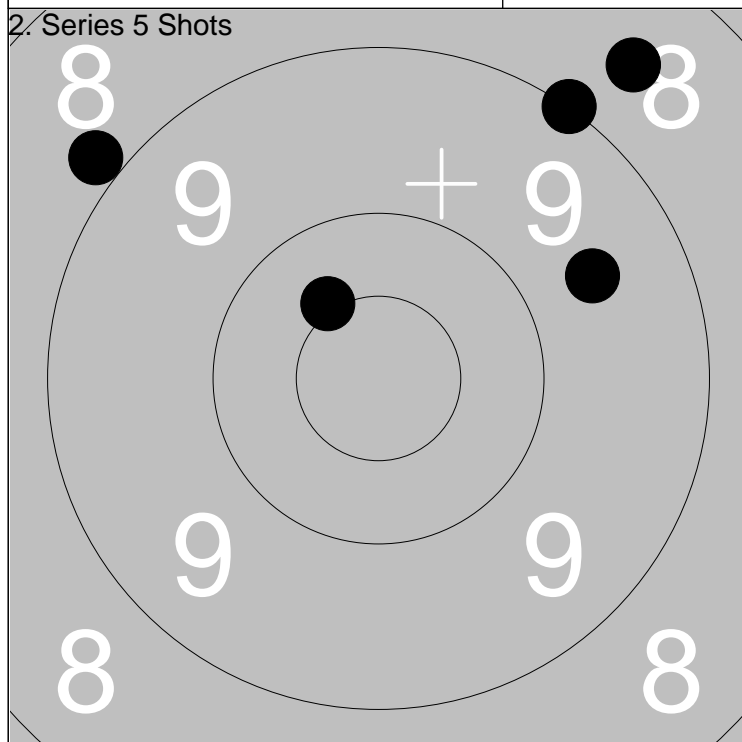

1: *10.4 ↖	Series	44.0
2: 8.6 ↗		
3: 9.0 ↗	Total	367.0
4: 9.6 →		
5: 8.9 ↖		

1: 8.7 ↘	Series	28.0
2: 6.1 →		
3: 2.1 →	Total	395.0
4: 5.5 →		
5: 7.6 →		

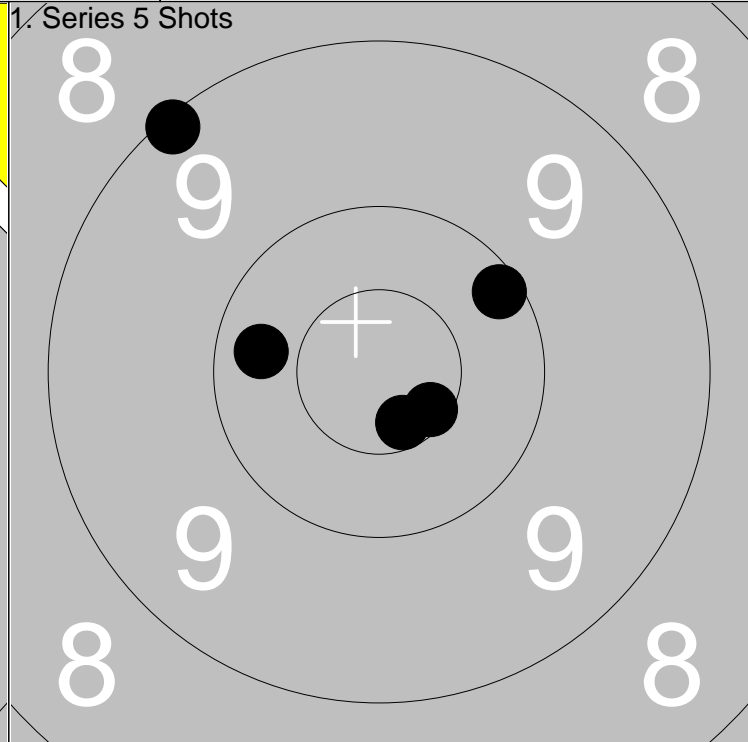
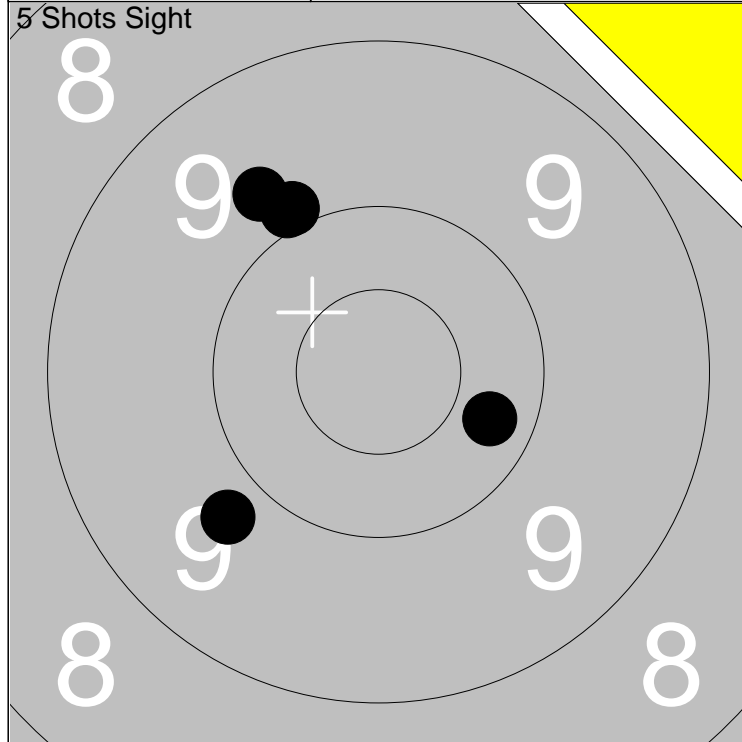

1: 9.7 ↗	Series	46.0
2: 9.8 ↘		
3: 9.9 ↗	Total	268.0
4: 9.9 ↗		
5: 10.3 ↘		

1: 10.3 ←	Series	49.0
2: *10.6 ↘		
3: 9.1 ↖	Total	317.0
4: 10.1 ↗		
5: *10.6 ↘		

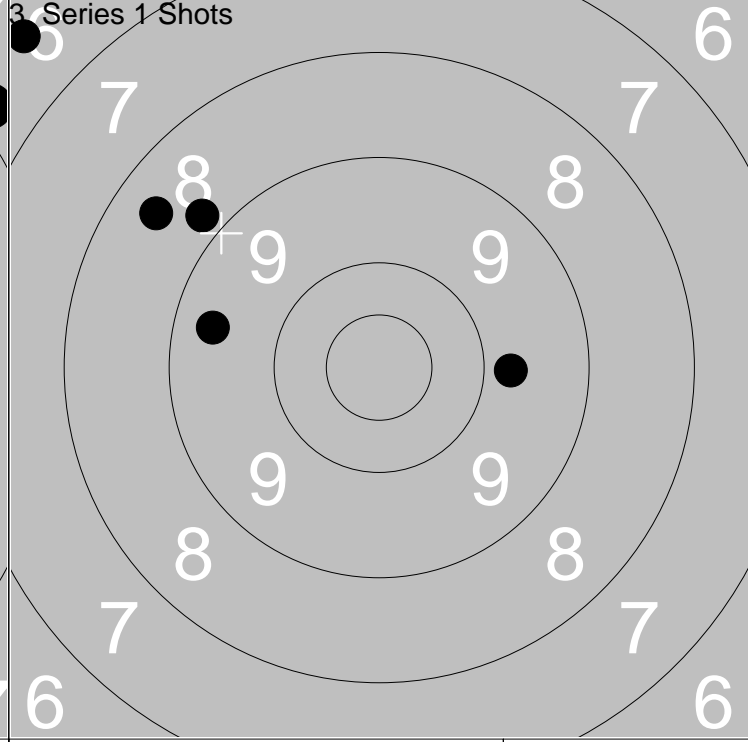
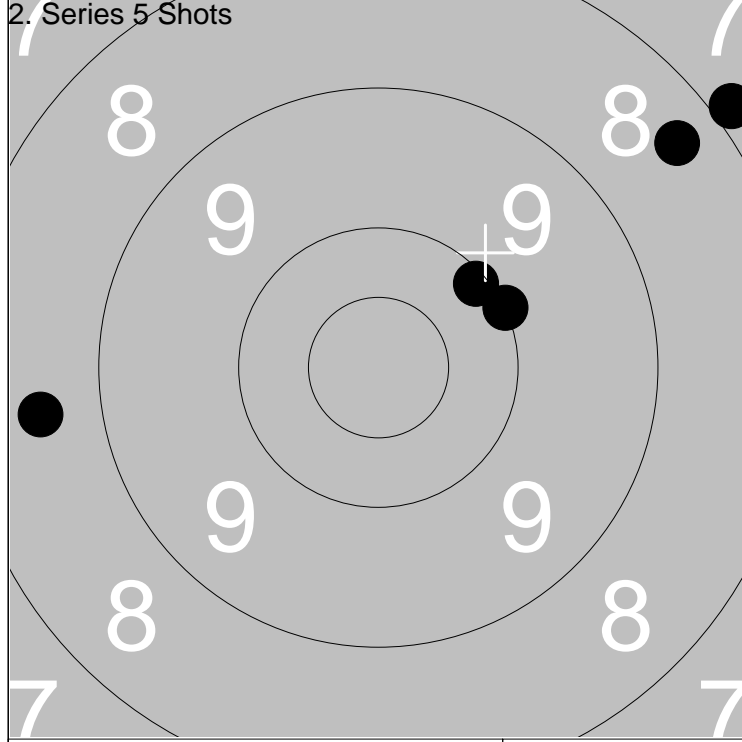

1: 10.1 ↗	Series	43.0
2: 7.9 ↗		
3: 8.4 ↗	Total	360.0
4: 8.6 ←		
5: 10.0 ↗		

1: 6.4 ↗	Series	40.0
2: 8.4 ↖		
3: 9.4 ←	Total	400.0
4: 9.8 →		
5: 8.8 ↖		

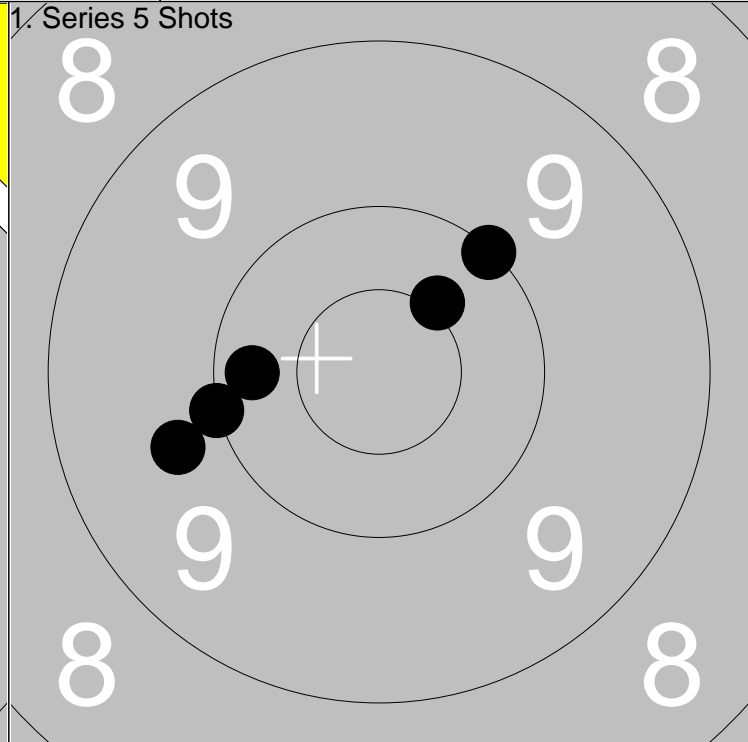
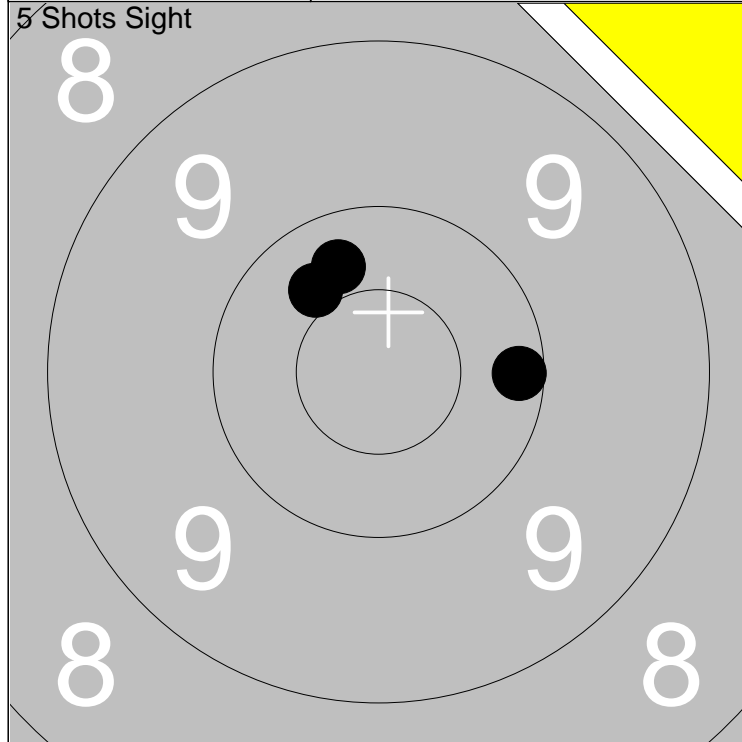

1: 10.2 →	Series	30.0
2: 10.3 ↗		
3: 10.4 ↖		
Total		281.0

1: 10.2 ←	Series	49.0
2: 10.0 ↗		
3: *10.4 ↗		
Total		330.0

4: 10.0 ←	Series	42.0
5: 9.7 ←		
Total		

1: 9.6 ↗	Series	42.0
2: 10.0 ↓		
3: 7.6 ↙		
Total		414.0

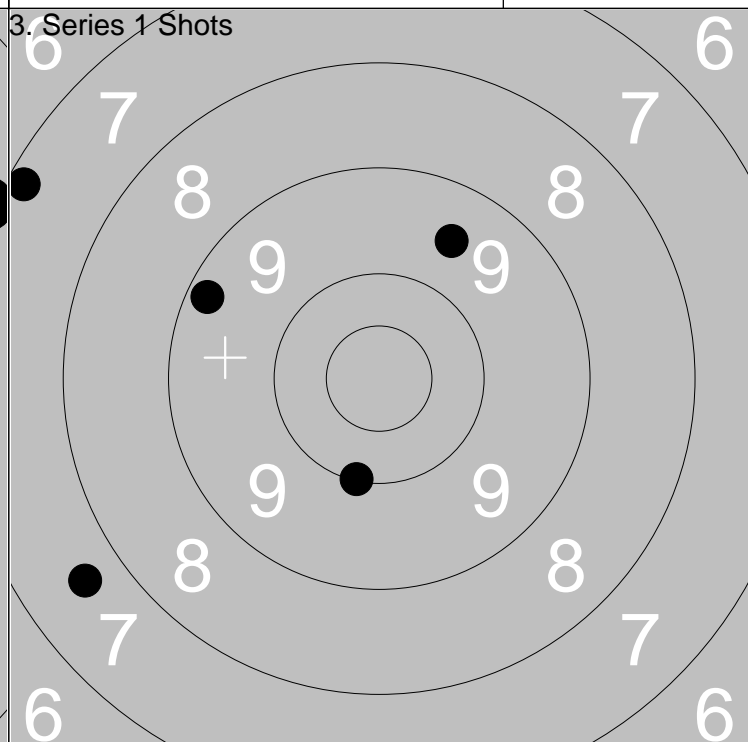
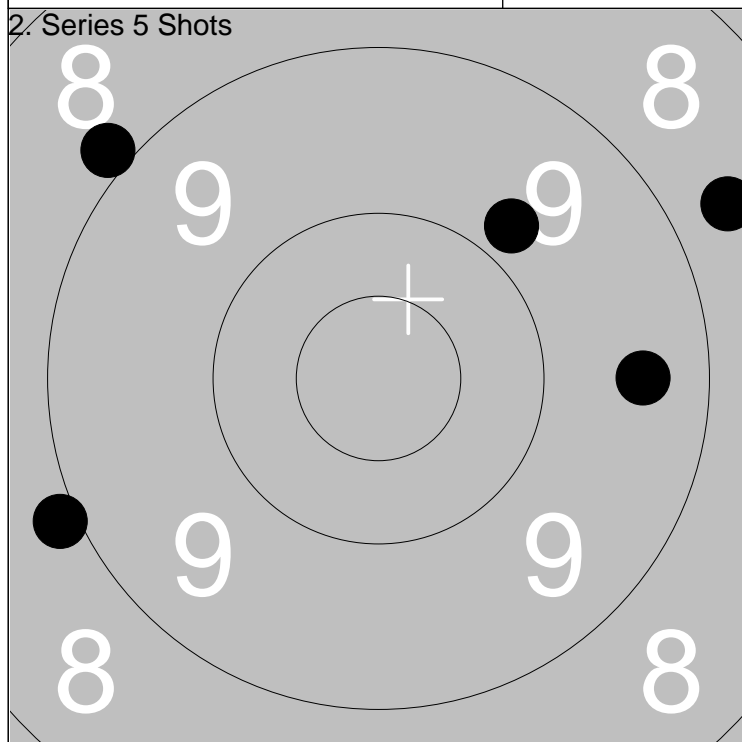

1: 9.8 ↗	Series	42.0
2: 8.7 ↗		
3: 9.4 →		
Total		372.0

4: 9.2 ↖	Series	42.0
5: 8.9 ←		
Total		

1: 9.6 ↗	Series	42.0
2: 10.0 ↓		
3: 7.6 ↙		
Total		414.0

4: 9.2 ↖	Series	42.0
5: 8.9 ←		
Total		

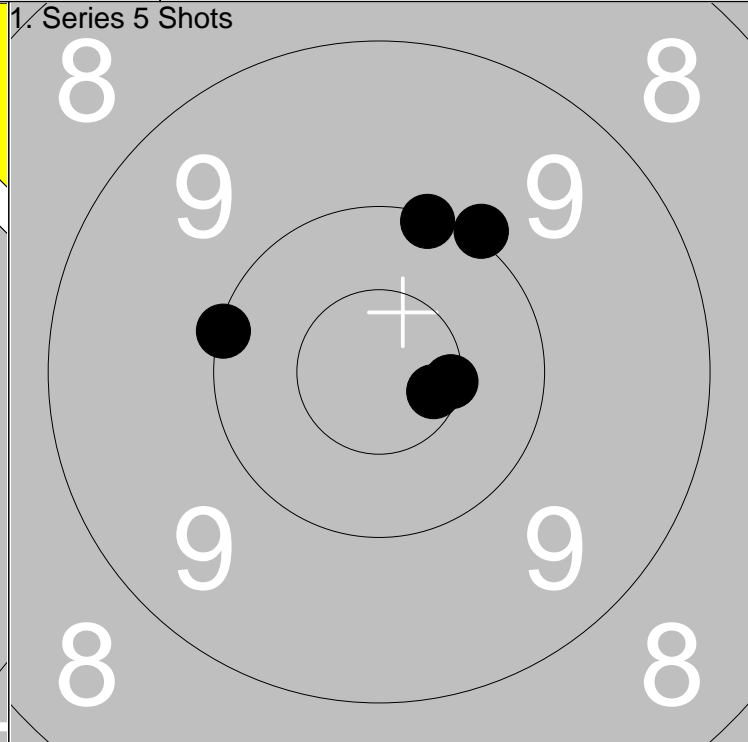
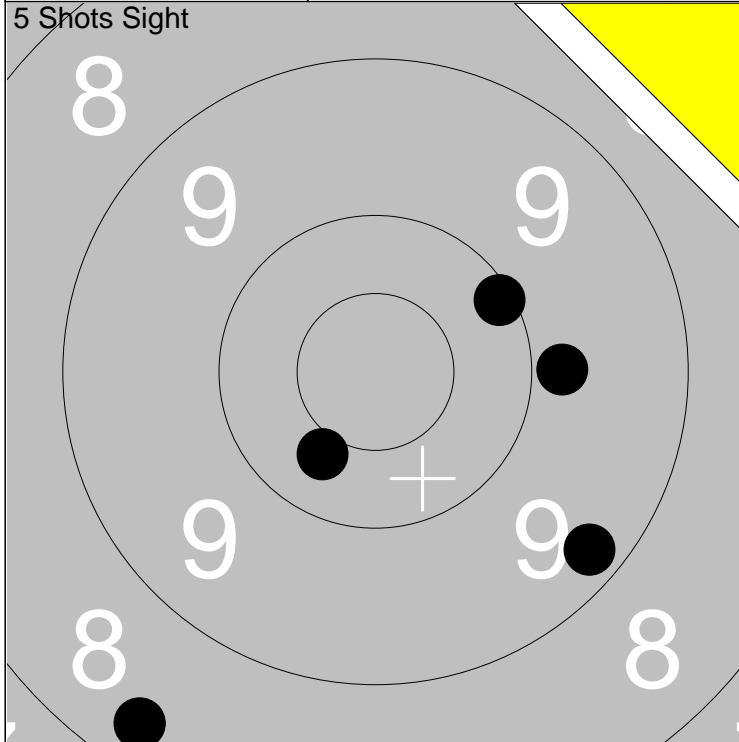

1: 9.8 →
2: 10.1 ↗
3: 9.3 ↘
4: 8.3 ↙
5: 10.4 ↙

Series	46.0
Total	266.0

1: *10.6 →
2: 10.0 ←
3: 10.0 ↗
4: 10.1 ↑
5: *10.5 →

Series	50.0
Total	316.0

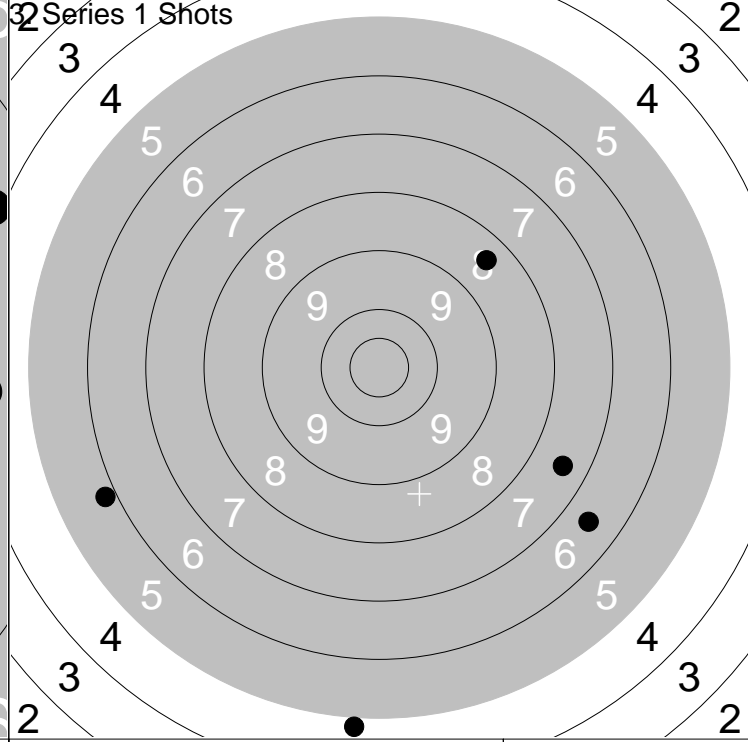
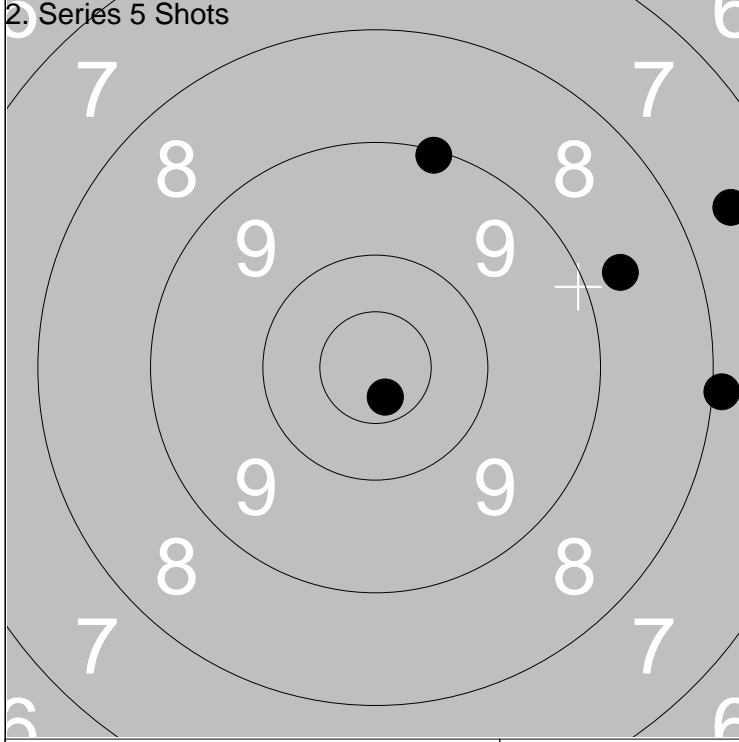

1: 9.1 ↑
2: 7.6 →
3: *10.7 ↘
4: 7.9 →
5: 8.7 →

Series	41.0
Total	357.0

1: 5.8 ←
2: 8.4 ↗
3: 6.6 ↘
4: 7.5 ↘
5: 4.9 ↓

Series	30.0
Total	387.0

Relay **6** Lane **18** **Petter Ivarsson**

300m Loos C Gä

2013-07-08 Tavelträffen B 2013 Ramselefors SKF

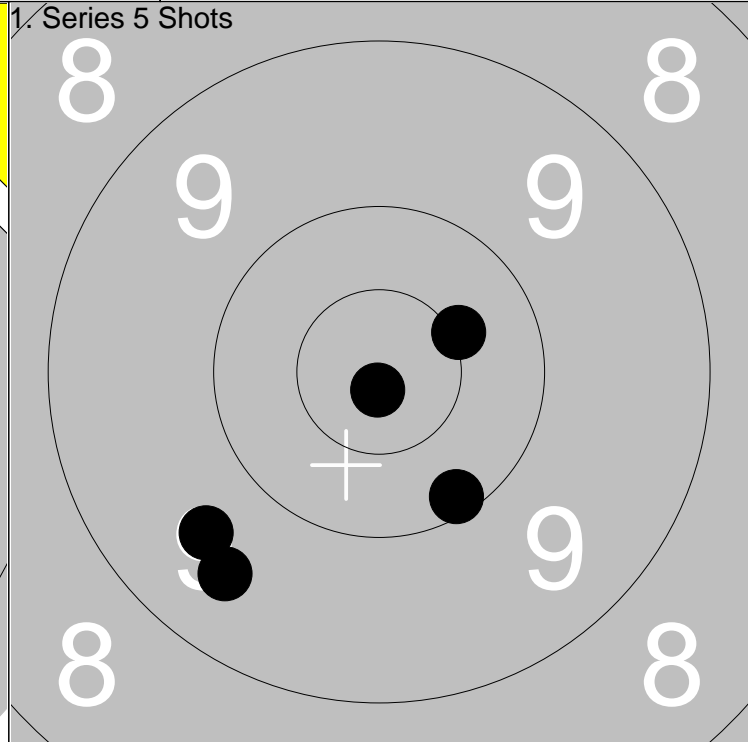
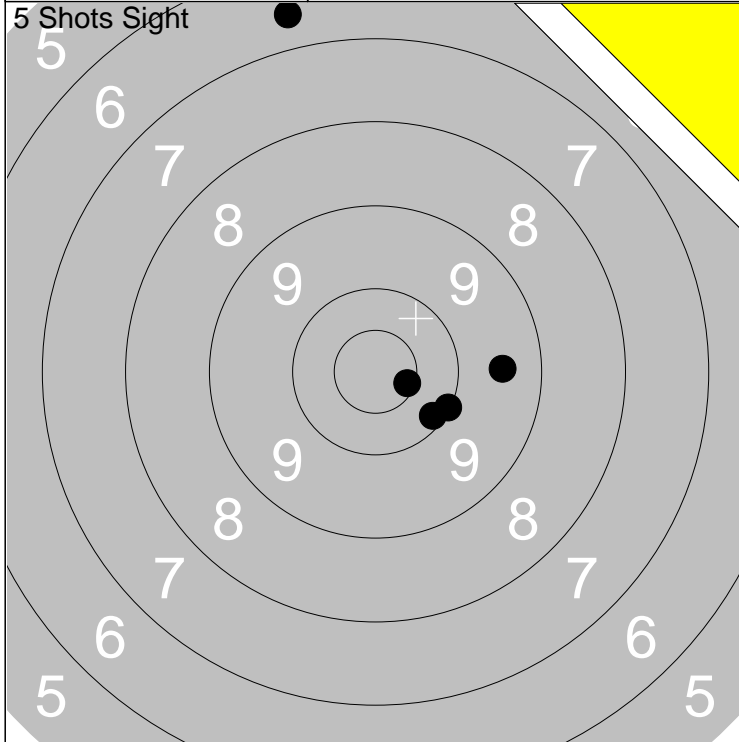

1: 9.5 →	Series	45.0
2: 10.1 ↘		
3: *10.6 →	Total	264.0
4: 6.6 ↑		
5: 10.1 ↘		

1: *10.5 →	Series	48.0
2: *10.8 ↓		
3: 10.1 ↘	Total	312.0
4: 9.5 ↘		
5: 9.6 ↘		

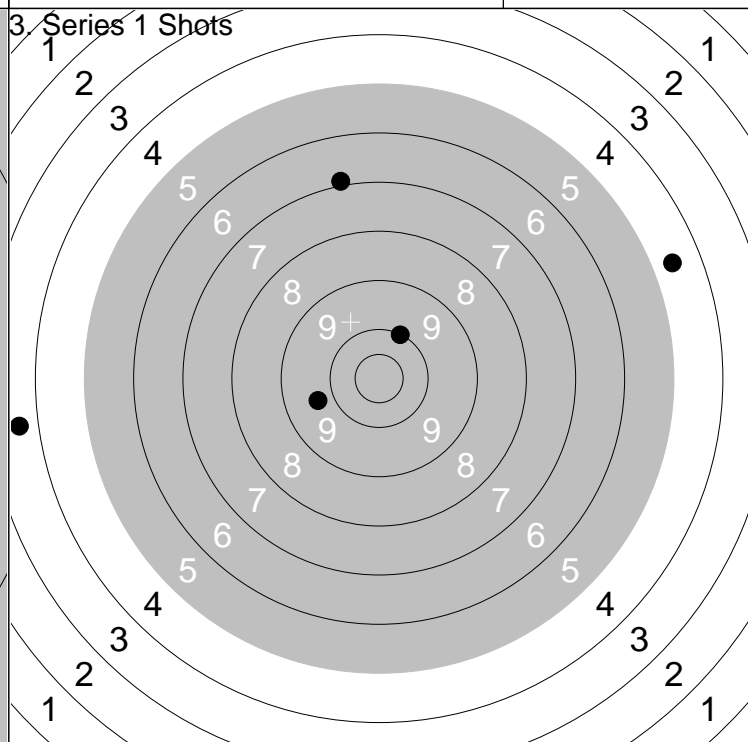
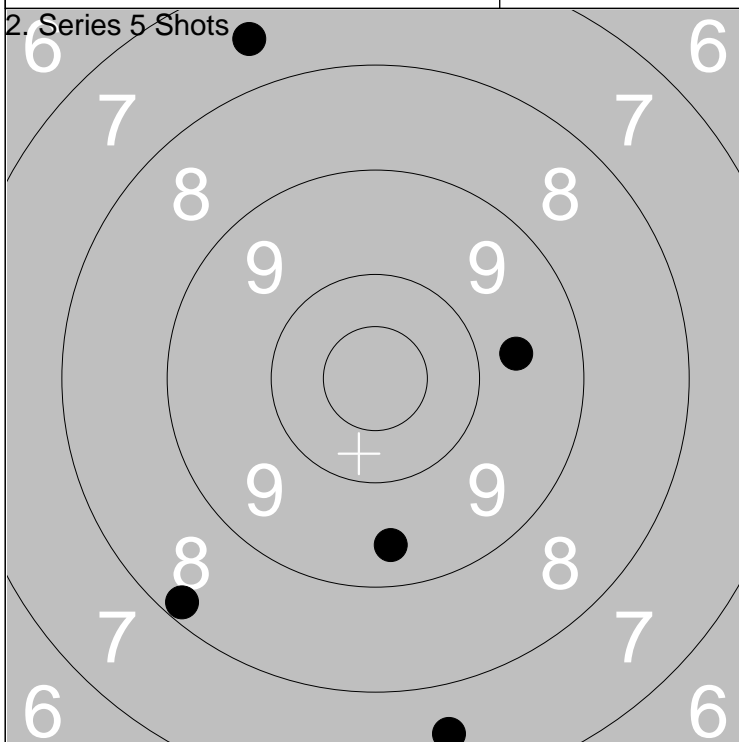

1: 8.2 ↙	Series	40.0
2: 7.6 ↑		
3: 7.6 ↓	Total	352.0
4: 9.7 →		
5: 9.4 ↓		

1: 4.6 →	Series	32.0
2: 9.7 ←		
3: 3.6 ←	Total	384.0
4: 10.0 ↑		
5: 6.9 ↑		

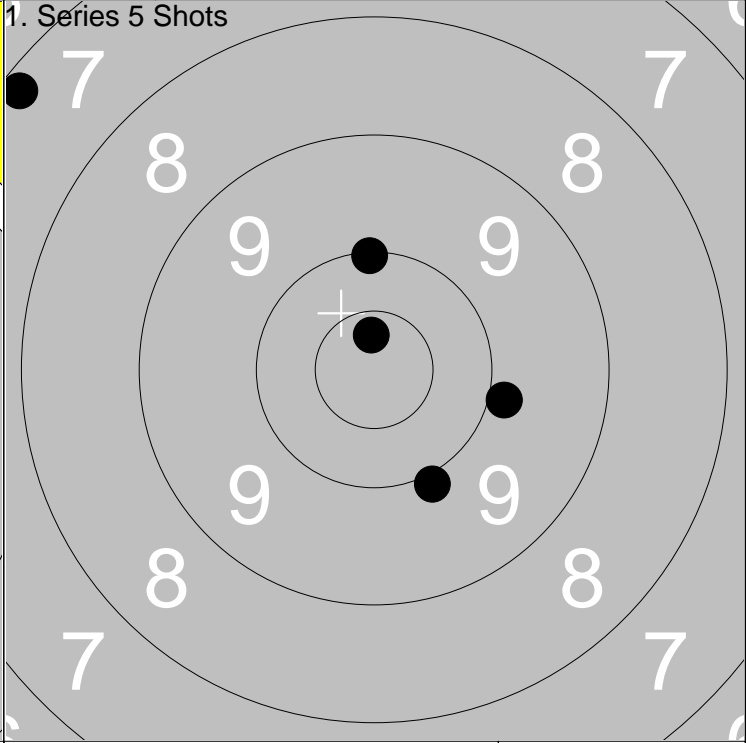
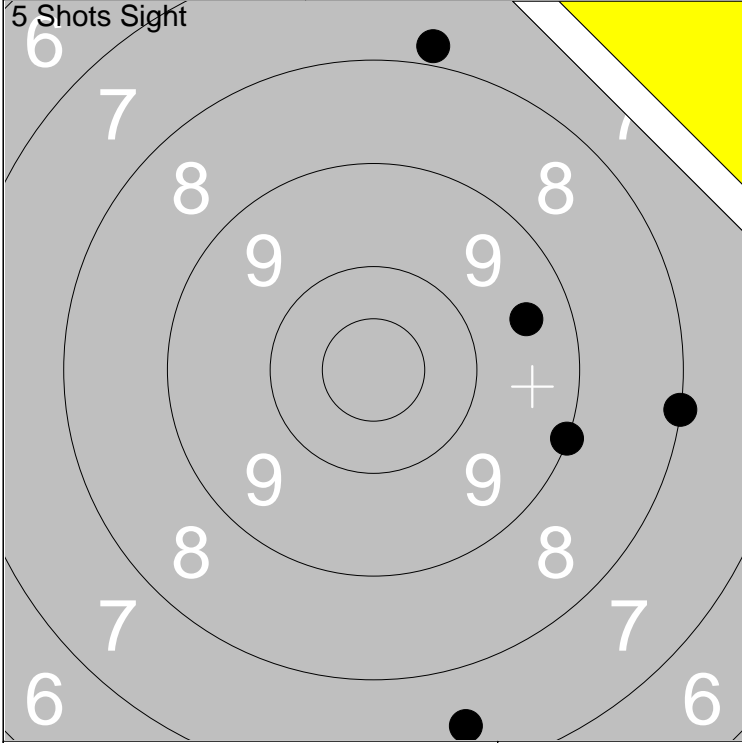

1: 9.0 →	Series	40.0
2: 9.5 →		
3: 8.0 →	Total	257.0
4: 7.5 ↓		
5: 7.8 ↑		

1: 7.2 ↖	Series	45.0
2: 9.9 ↓		
3: 10.0 ↑	Total	302.0
4: *10.7 ↑		
5: 9.9 →		

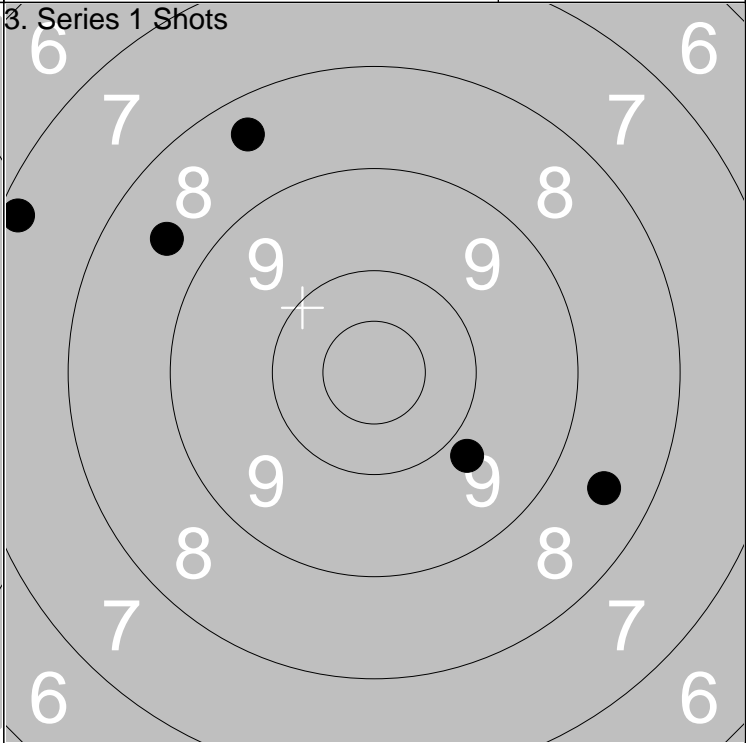
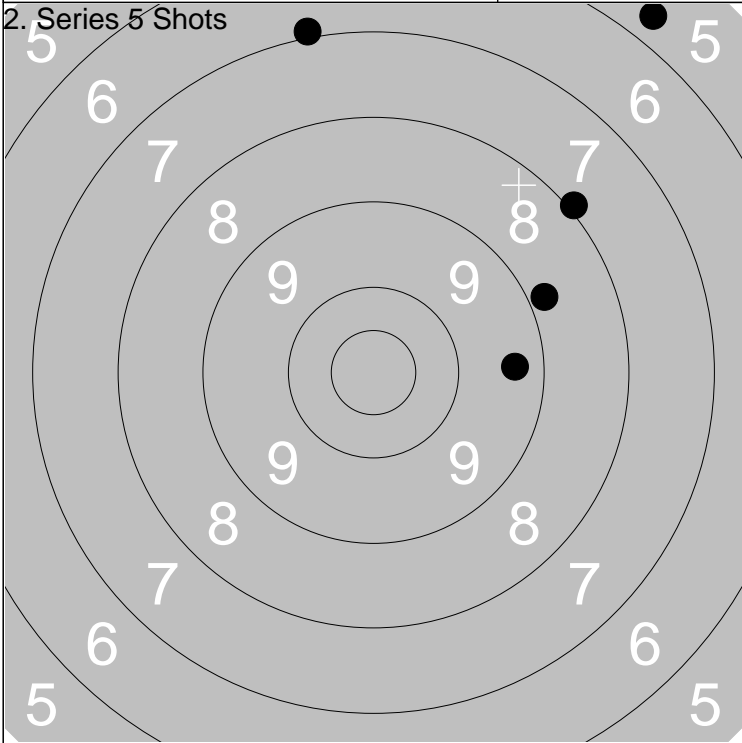

1: 9.4 →	Series	37.0
2: 8.8 →		
3: 8.0 ↗	Total	339.0
4: 7.0 ↑		
5: 5.7 ↗		

1: 8.4 ↗	Series	40.0
2: 9.8 ↓		
3: 8.6 ↗	Total	379.0
4: 8.5 ↓		
5: 7.2 ↖		

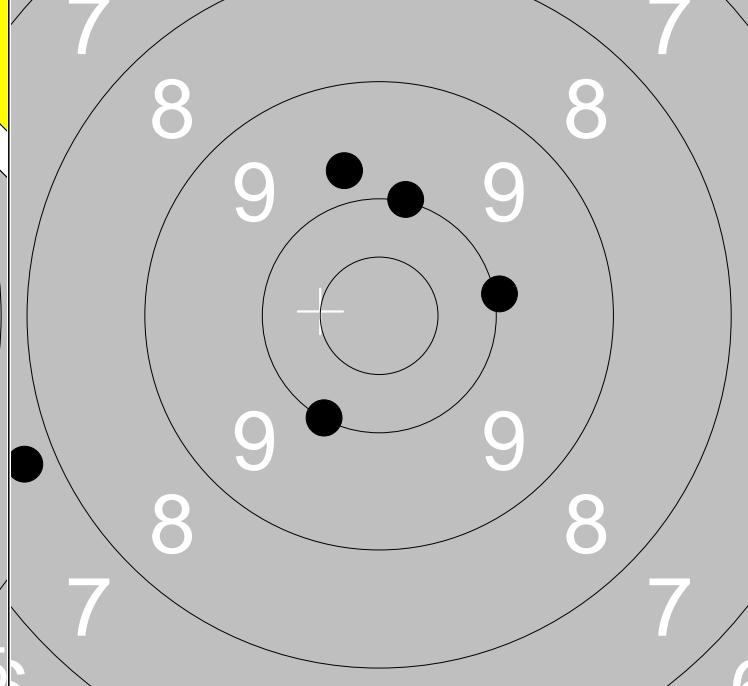
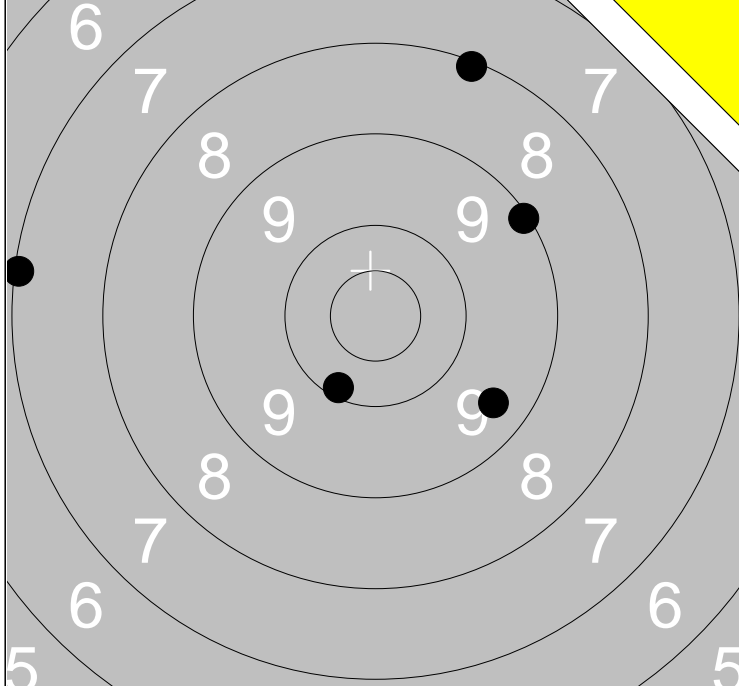

1: 9.1 ↗
2: 8.1 ↑
3: 10.1 ↓
4: 9.4 ↘
5: 7.1 ←

Series	43.0
Total	255.0

1: 7.8 ←
2: 9.8 ↑
3: 10.0 ↑
4: 10.0 ↓
5: 10.0 →

Series	46.0
Total	301.0

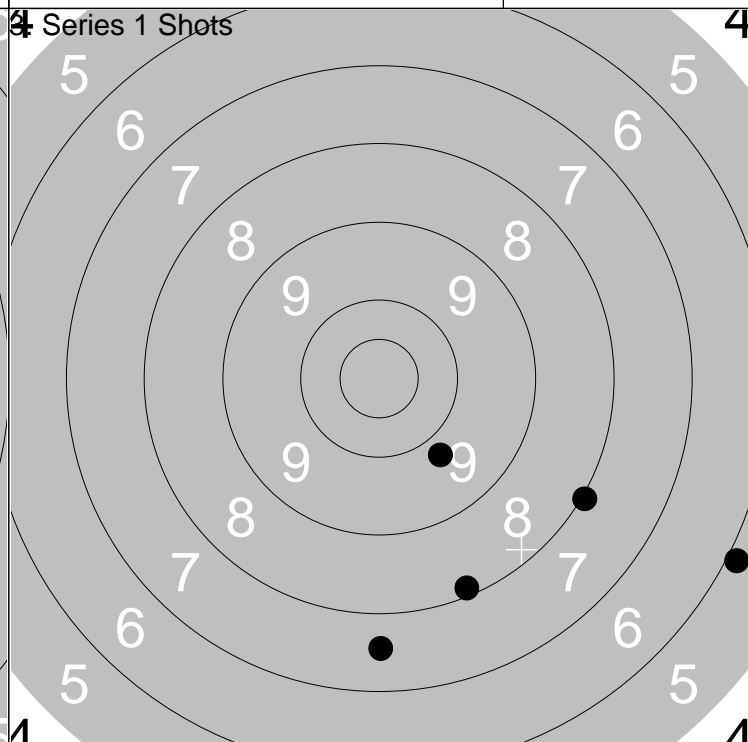
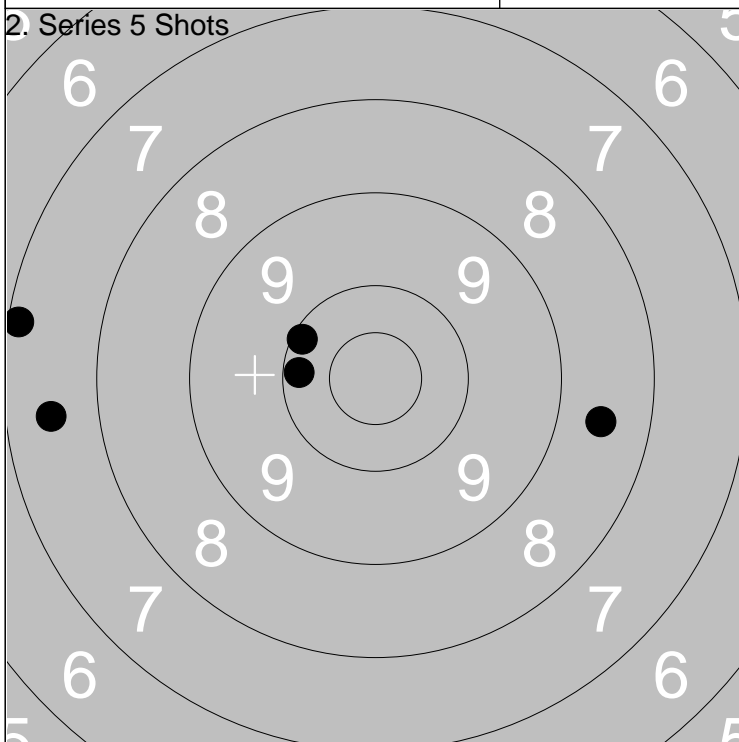

1: 7.1 ←
2: 7.5 ←
3: 8.6 →
4: 10.1 ↖
5: 10.2 ←

Series	42.0
Total	343.0

1: 8.1 ↓
2: 7.6 ↓
3: 9.8 ↓
4: 5.9 ↘
5: 8.0 ↘

Series	37.0
Total	380.0

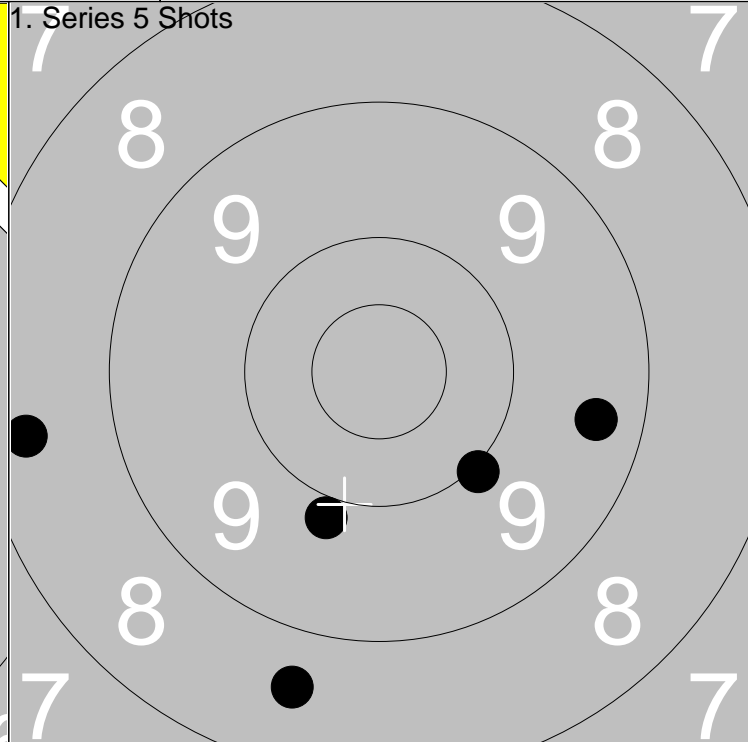
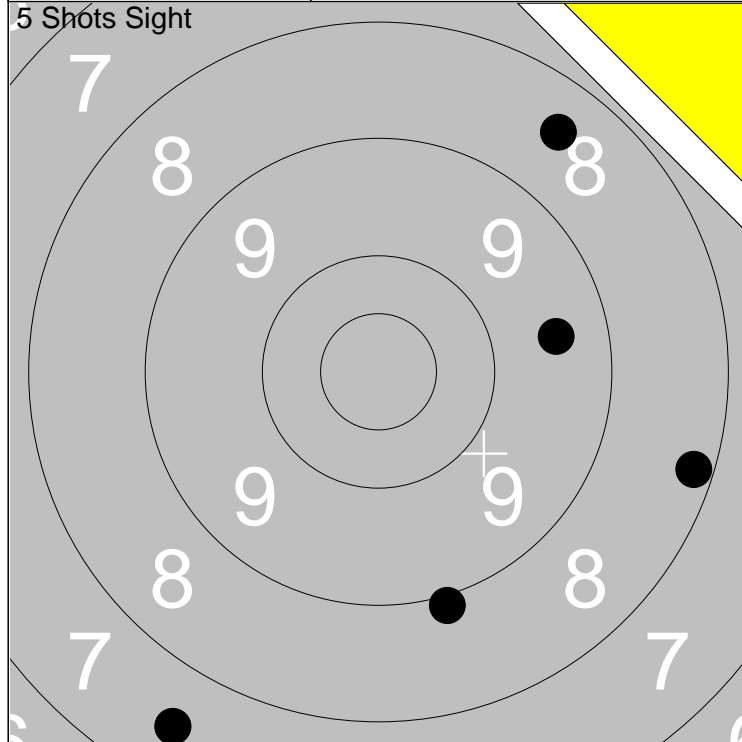

1: 9.5 →	Series	40.0
2: 8.2 →		
3: 8.9 ↓		
4: 8.5 ↗		
5: 7.5 ↓		

Total		249.0
-------	--	-------

1: 9.9 ↓	Series	44.0
2: 10.0 ↘		
3: 8.4 ←		
4: 8.6 ↓		
5: 9.4 →		

Total		293.0
-------	--	-------

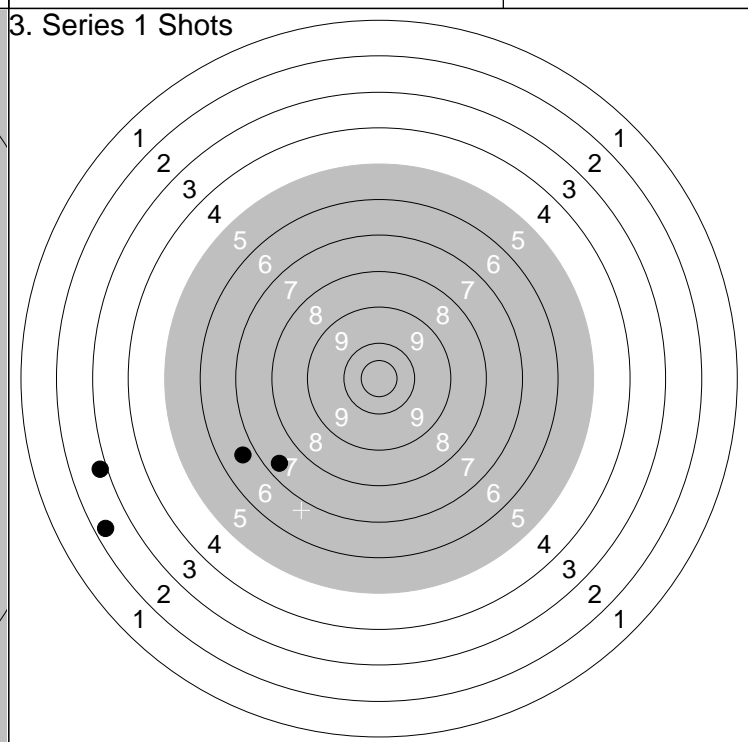
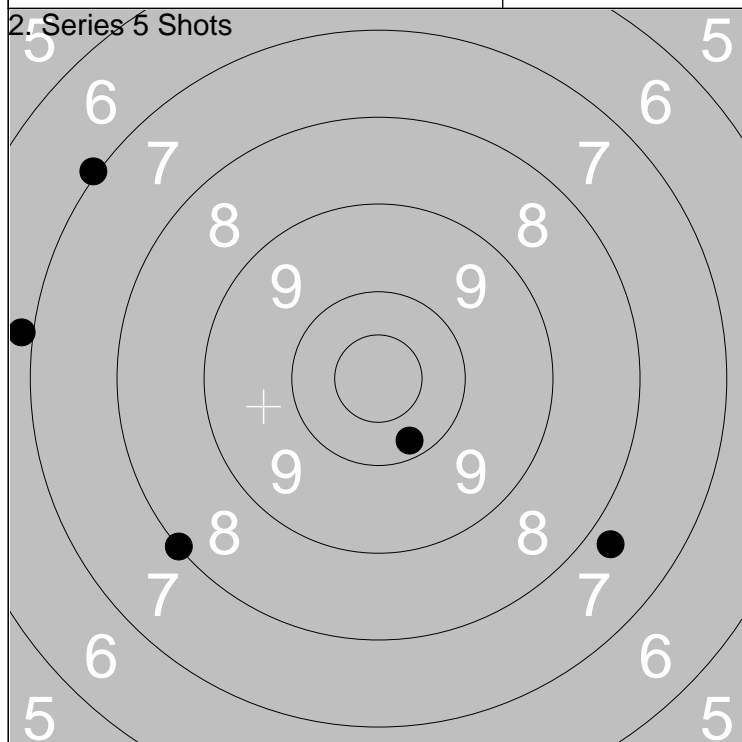

1: 7.8 ↘	Series	38.0
2: 6.9 ←		
3: 7.0 ↖		
4: 8.0 ↙		
5: 10.2 ↓		

Total		331.0
-------	--	-------

1: 2.9 ←	Series	17.0
2: 0.0 →		
3: 7.4 ↙		
4: 6.7 ←		
5: 2.3 ←		

Total		348.0
-------	--	-------

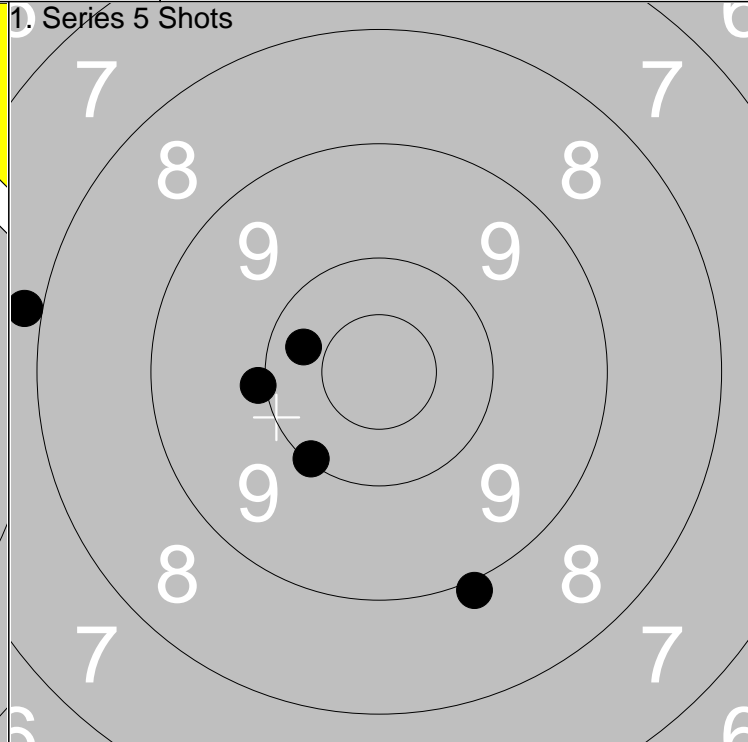
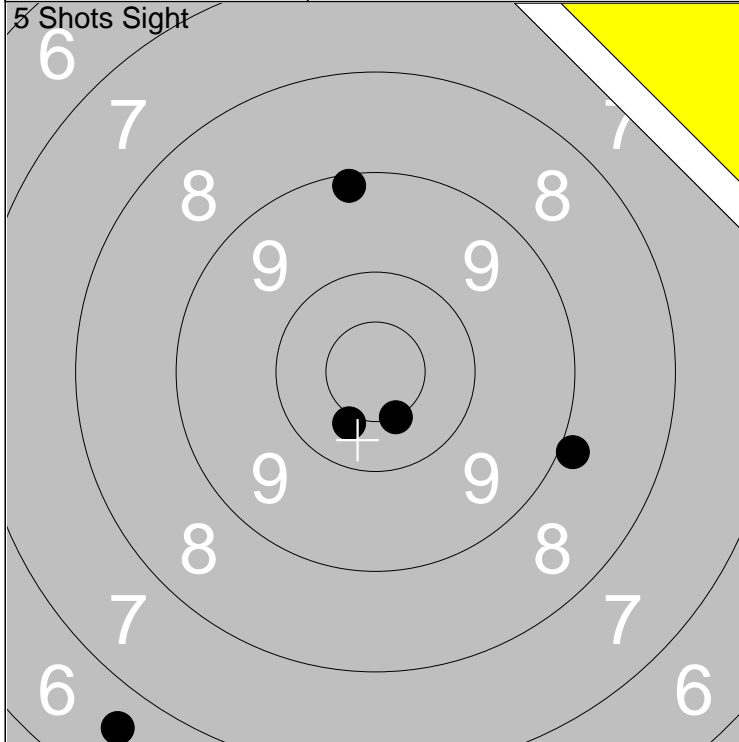

1: 9.1 ↑
2: *10.5 ↓
3: 8.9 →
4: *10.4 ↓
5: 6.6 ↓

Series	43.0
Total	248.0

1: 10.3 ←
2: 8.9 ↓
3: 10.1 ↓
4: 7.9 ←
5: 10.0 ←

Series	45.0
Total	293.0

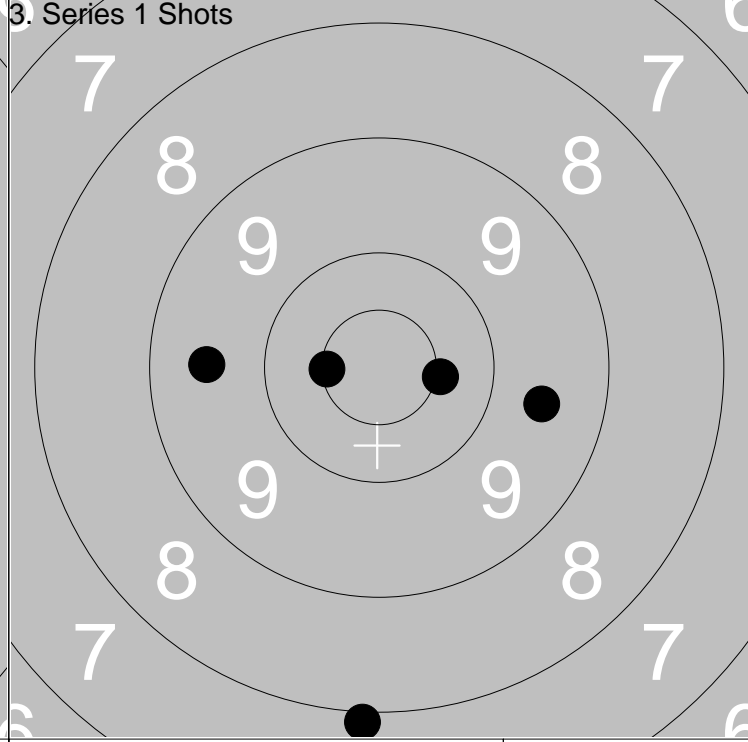
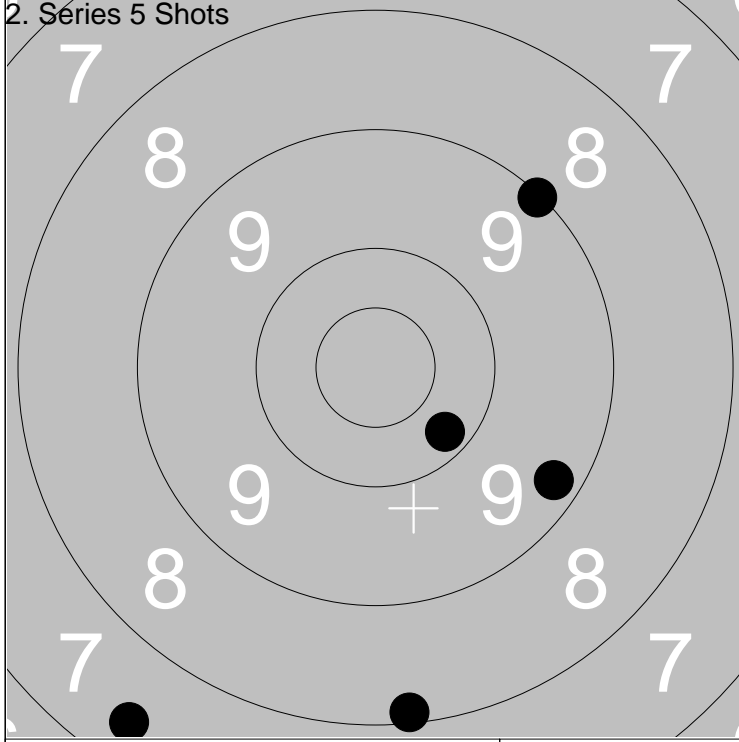

1: 10.2 ↓
2: 9.3 ↓
3: 7.4 ↓
4: 8.1 ↓
5: 9.1 ↗

Series	43.0
Total	336.0

1: *10.5 →
2: 9.5 ←
3: *10.5 ←
4: 7.9 ↓
5: 9.6 →

Series	45.0
Total	381.0

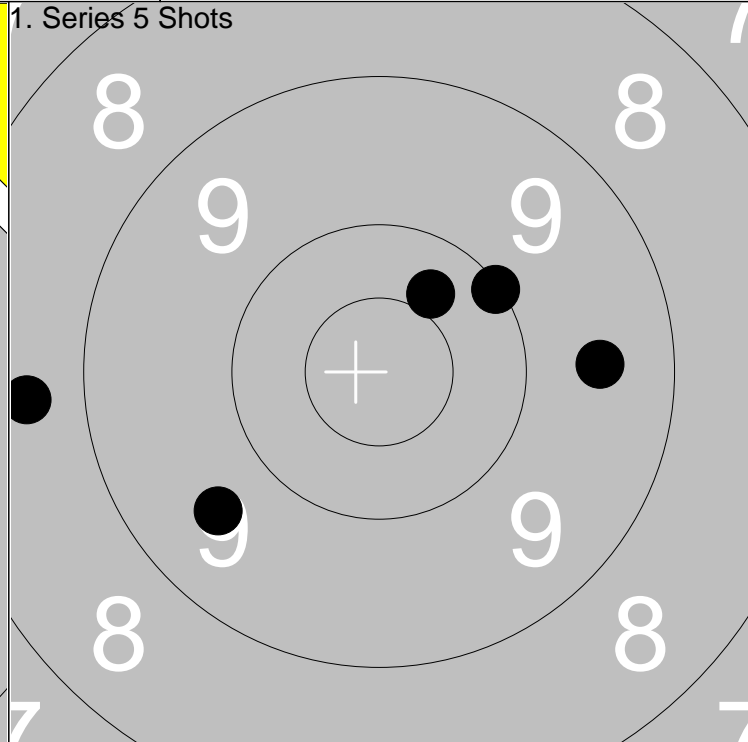
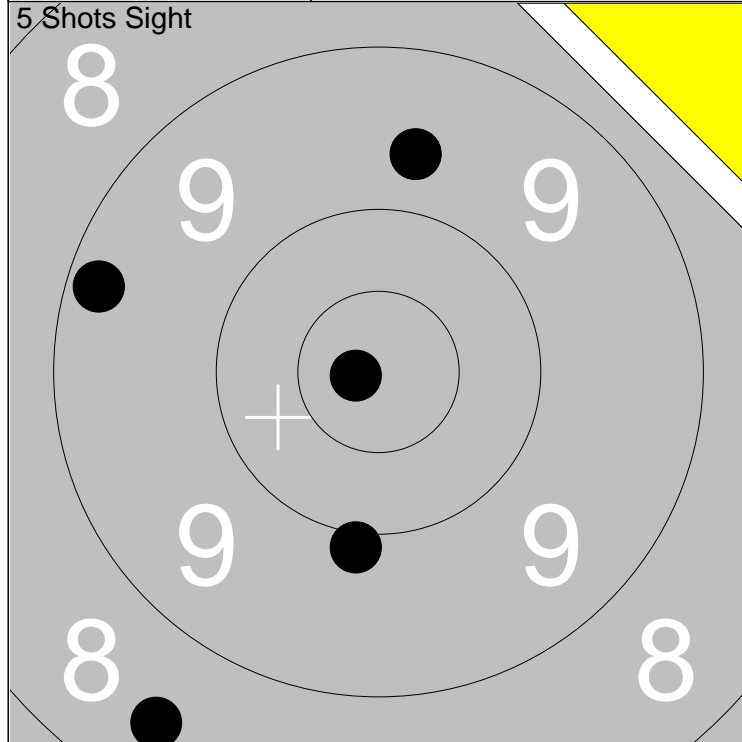

1: 8.5 ↙	Series 45.0
2: 9.7 ↑	
3: *10.8 ←	Total 247.0
4: 9.2 ↙	
5: 9.9 ↓	

1: 8.6 ←	Series 46.0
2: 9.5 →	
3: 10.1 ↗	Total 293.0
4: 10.4 ↗	
5: 9.6 ↙	

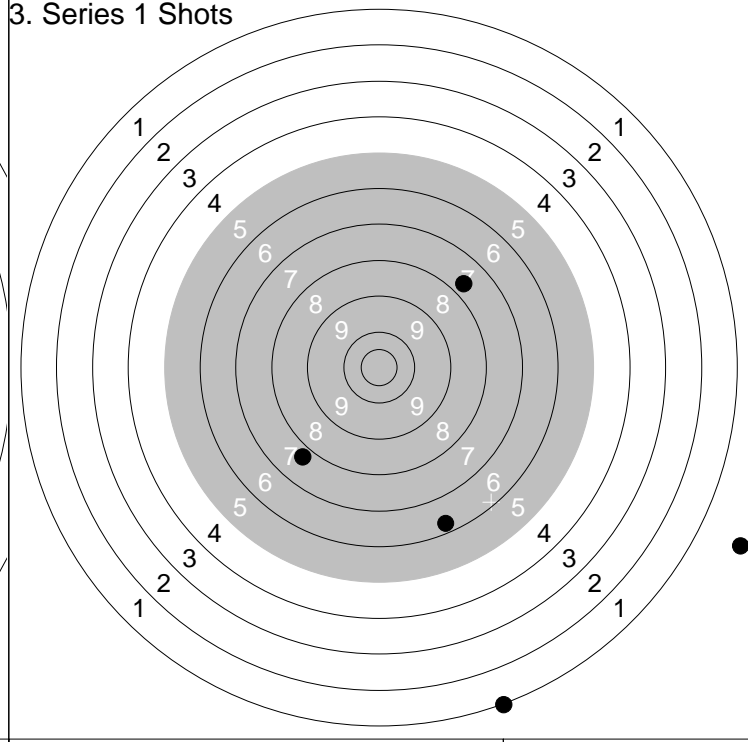
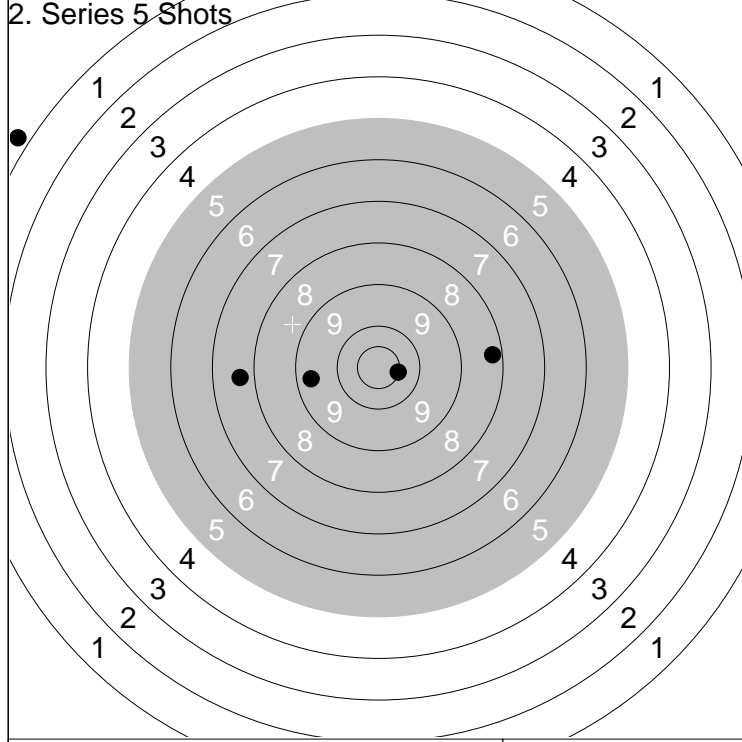

1: 7.7 ←	Series 34.0
2: 0.0 ↙	
3: 9.4 ←	Total 327.0
4: *10.5 →	
5: 8.3 →	

1: 7.7 ↗	Series 21.0
2: 7.8 ↙	
3: 6.3 ↓	Total 348.0
4: 0.0 →	
5: 1.0 ↓	