

1:	6.8	↖
2:	5.4	←
3:	7.7	←
4:	8.9	↙
5:	10.1	↙
6:	*10.6	↑
7:	9.7	↘
8:	8.8	↗
9:	*10.4	↗
10:	9.6	↗
Serie		82.0
Total		0.0

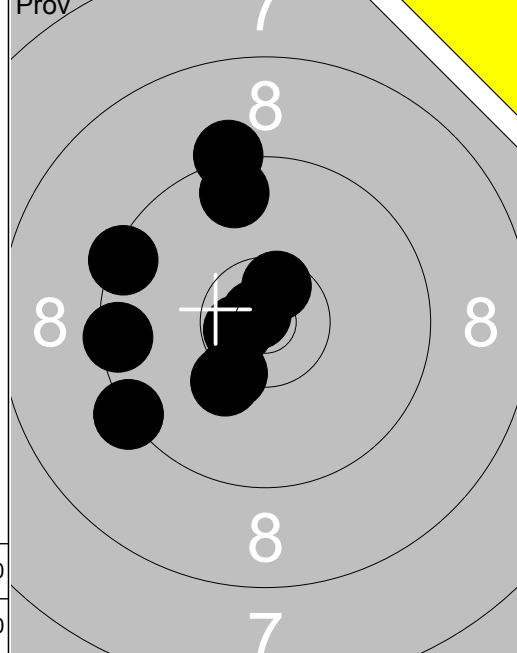

11:	9.3	↖
12:	9.5	←
13:	9.2	↑
14:	9.4	↙
15:	10.2	↙
16:	*10.6	↑
17:	*10.3	↙
18:	*10.8	↖
19:	9.6	↑
20:	*10.7	←
Serie		95.0
Total		0.0

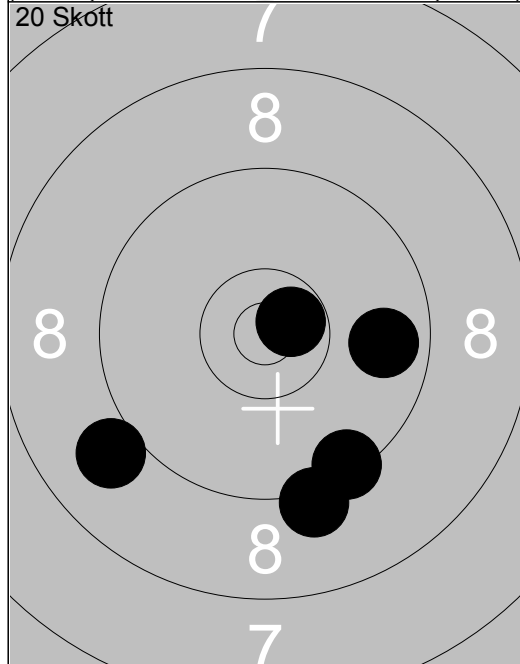

1:	9.8	→
2:	*10.7	↗
3:	9.0	↙
4:	9.4	↘
5:	9.2	↘
Serie		46.0
Total		46.0

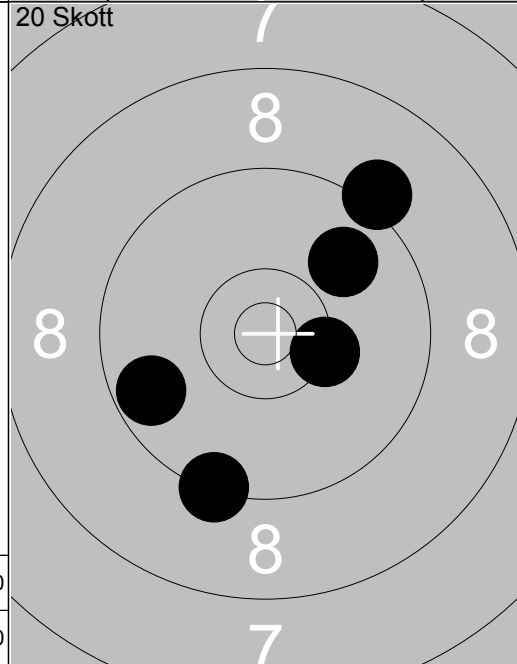

6:	9.2	↗
7:	9.9	↗
8:	*10.3	→
9:	9.7	↙
10:	9.3	↘
Serie		46.0
Total		92.0

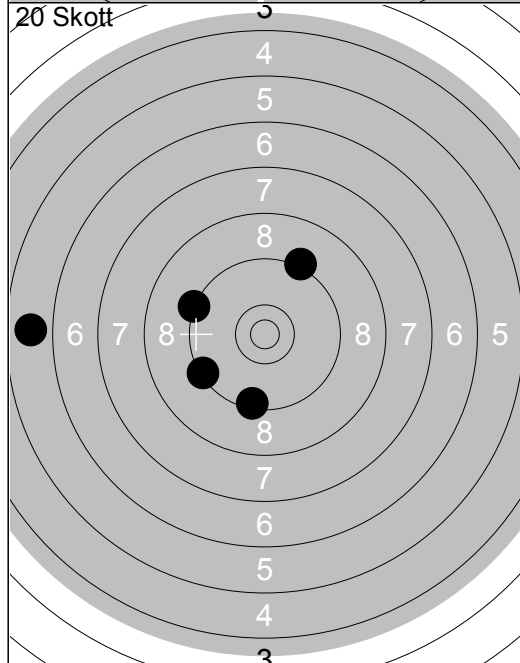

11:	9.4	↘
12:	9.3	←
13:	9.4	↙
14:	9.2	↗
15:	5.8	←
Serie		41.0
Total		133.0

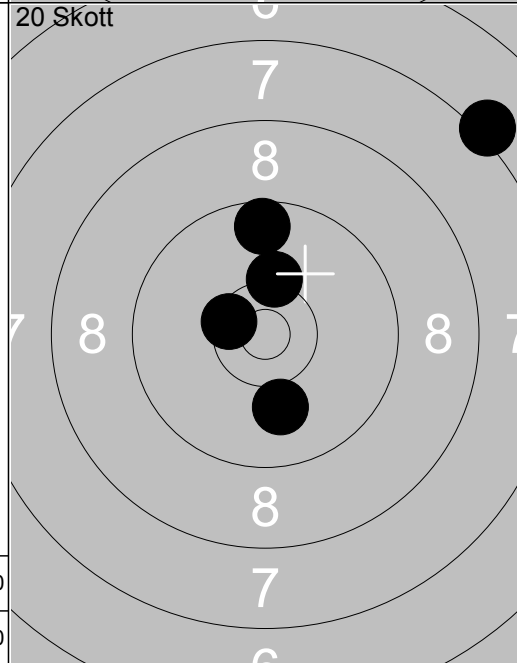

16:	10.3	↑
17:	9.6	↑
18:	*10.5	↙
19:	10.0	↘
20:	7.2	↗
Serie		46.0
Total		179.0

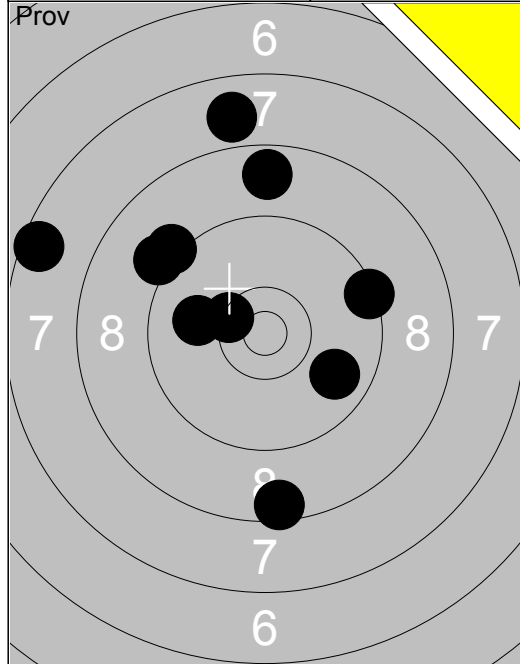

1:	8.7	↑
2:	7.5	↖
3:	9.2	↗
4:	9.1	↗
5:	7.9	↑
6:	*10.4	↖
7:	9.4	→
8:	9.8	↘
9:	10.0	←
10:	8.5	↓
Serie		86.0
Total		0.0

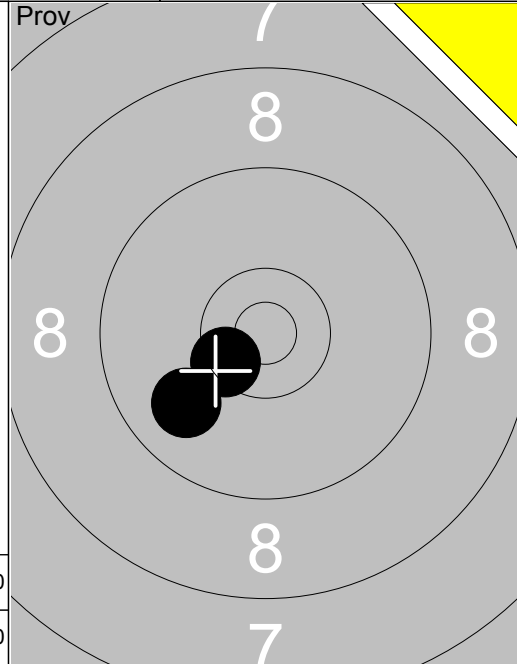

11:	9.9	↘
12:	*10.5	↖
Serie		19.0
Total		0.0

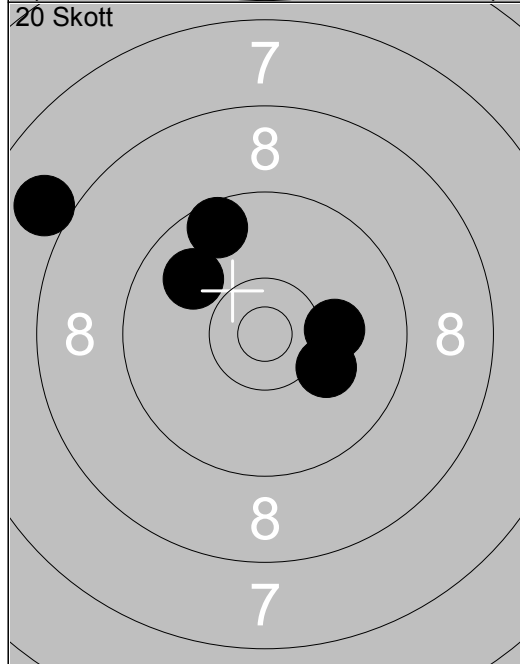

1:	10.1	→
2:	9.6	↗
3:	9.9	↗
4:	8.0	↗
5:	10.1	↘
Serie		46.0
Total		46.0

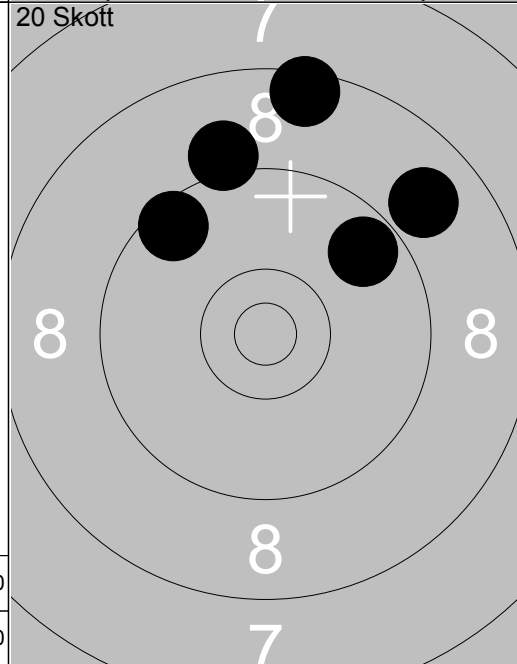

6:	8.5	↑
7:	9.7	↗
8:	9.5	↖
9:	8.9	↗
10:	9.1	↑
Serie		43.0
Total		89.0

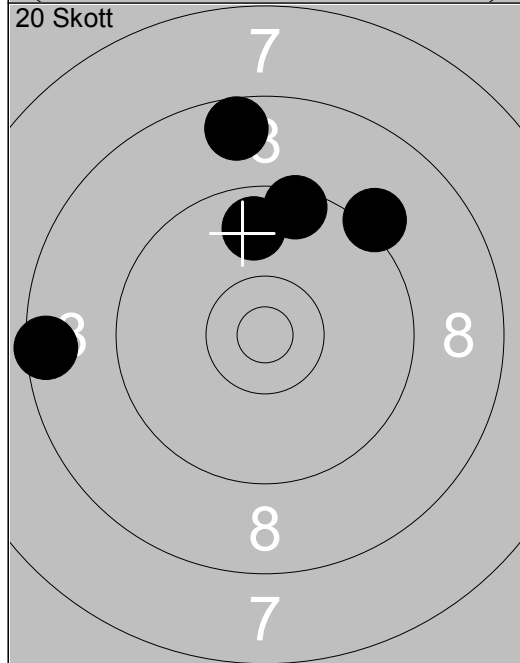

11:	9.8	↑
12:	8.5	←
13:	8.6	↑
14:	9.2	↗
15:	9.5	↑
Serie		43.0
Total		132.0

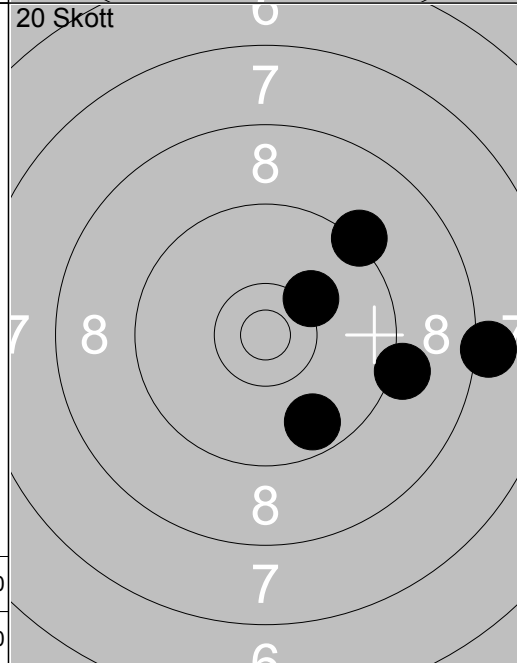

16:	9.2	↗
17:	9.2	→
18:	10.2	↗
19:	8.1	→
20:	9.7	↘
Serie		45.0
Total		177.0

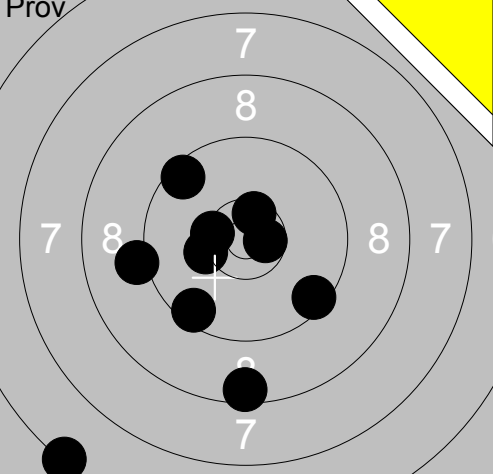
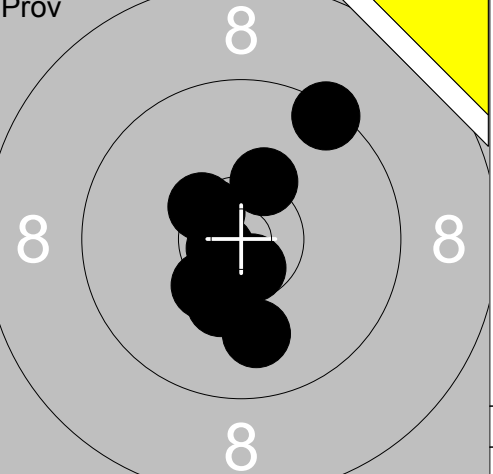
	<table border="1" style="width:100%; border-collapse: collapse;"> <tr><td>1:</td><td>6.3</td><td>↙</td></tr> <tr><td>2:</td><td>9.5</td><td>↘</td></tr> <tr><td>3:</td><td>*10.4</td><td>←</td></tr> <tr><td>4:</td><td>9.5</td><td>↘</td></tr> <tr><td>5:</td><td>10.3</td><td>←</td></tr> <tr><td>6:</td><td>9.5</td><td>↗</td></tr> <tr><td>7:</td><td>9.2</td><td>←</td></tr> <tr><td>8:</td><td>*10.5</td><td>↑</td></tr> <tr><td>9:</td><td>*10.6</td><td>→</td></tr> <tr><td>10:</td><td>8.5</td><td>↓</td></tr> <tr><td colspan="2">Serie</td><td style="text-align: right;">90.0</td></tr> <tr><td colspan="2">Total</td><td style="text-align: right;">0.0</td></tr> </table>	1:	6.3	↙	2:	9.5	↘	3:	*10.4	←	4:	9.5	↘	5:	10.3	←	6:	9.5	↗	7:	9.2	←	8:	*10.5	↑	9:	*10.6	→	10:	8.5	↓	Serie		90.0	Total		0.0		<table border="1" style="width:100%; border-collapse: collapse;"> <tr><td>11:</td><td>*10.7</td><td>↖</td></tr> <tr><td>12:</td><td>*10.3</td><td>↗</td></tr> <tr><td>13:</td><td>*10.5</td><td>↖</td></tr> <tr><td>14:</td><td>10.3</td><td>↓</td></tr> <tr><td>15:</td><td>*10.7</td><td>↓</td></tr> <tr><td>16:</td><td>*10.4</td><td>↖</td></tr> <tr><td>17:</td><td>10.0</td><td>↓</td></tr> <tr><td>18:</td><td>*10.3</td><td>↘</td></tr> <tr><td>19:</td><td>9.4</td><td>↗</td></tr> <tr><td>20:</td><td>*10.6</td><td>↓</td></tr> <tr><td colspan="2">Serie</td><td style="text-align: right;">99.0</td></tr> <tr><td colspan="2">Total</td><td style="text-align: right;">0.0</td></tr> </table>	11:	*10.7	↖	12:	*10.3	↗	13:	*10.5	↖	14:	10.3	↓	15:	*10.7	↓	16:	*10.4	↖	17:	10.0	↓	18:	*10.3	↘	19:	9.4	↗	20:	*10.6	↓	Serie		99.0	Total		0.0
1:	6.3	↙																																																																									
2:	9.5	↘																																																																									
3:	*10.4	←																																																																									
4:	9.5	↘																																																																									
5:	10.3	←																																																																									
6:	9.5	↗																																																																									
7:	9.2	←																																																																									
8:	*10.5	↑																																																																									
9:	*10.6	→																																																																									
10:	8.5	↓																																																																									
Serie		90.0																																																																									
Total		0.0																																																																									
11:	*10.7	↖																																																																									
12:	*10.3	↗																																																																									
13:	*10.5	↖																																																																									
14:	10.3	↓																																																																									
15:	*10.7	↓																																																																									
16:	*10.4	↖																																																																									
17:	10.0	↓																																																																									
18:	*10.3	↘																																																																									
19:	9.4	↗																																																																									
20:	*10.6	↓																																																																									
Serie		99.0																																																																									
Total		0.0																																																																									

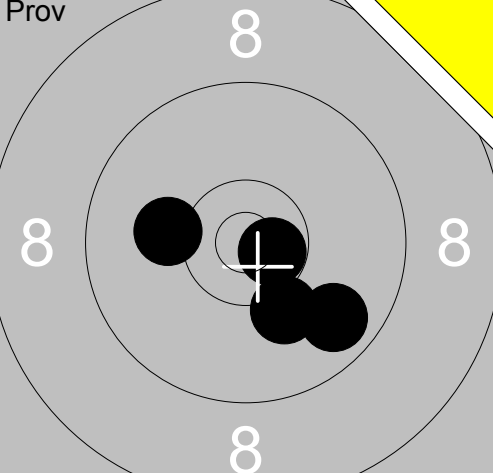
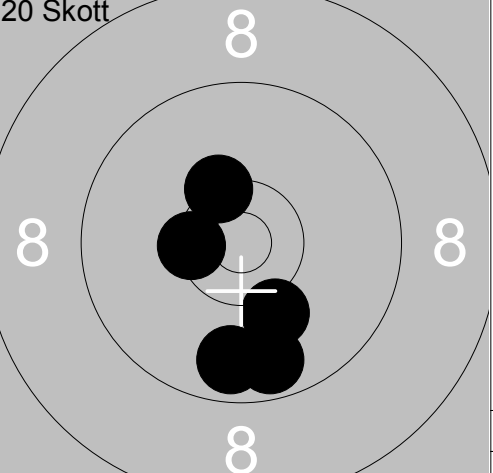
	<table border="1" style="width:100%; border-collapse: collapse;"> <tr><td>21:</td><td>10.1</td><td>↘</td></tr> <tr><td>22:</td><td>*10.7</td><td>↗</td></tr> <tr><td>23:</td><td>9.8</td><td>↘</td></tr> <tr><td>24:</td><td>10.1</td><td>←</td></tr> <tr><td colspan="2">Serie</td><td style="text-align: right;">39.0</td></tr> <tr><td colspan="2">Total</td><td style="text-align: right;">0.0</td></tr> </table>	21:	10.1	↘	22:	*10.7	↗	23:	9.8	↘	24:	10.1	←	Serie		39.0	Total		0.0		<table border="1" style="width:100%; border-collapse: collapse;"> <tr><td>1:</td><td>*10.4</td><td>←</td></tr> <tr><td>2:</td><td>9.7</td><td>↓</td></tr> <tr><td>3:</td><td>*10.3</td><td>↗</td></tr> <tr><td>4:</td><td>9.7</td><td>↓</td></tr> <tr><td>5:</td><td>10.1</td><td>↓</td></tr> <tr><td colspan="2">Serie</td><td style="text-align: right;">48.0</td></tr> <tr><td colspan="2">Total</td><td style="text-align: right;">48.0</td></tr> </table>	1:	*10.4	←	2:	9.7	↓	3:	*10.3	↗	4:	9.7	↓	5:	10.1	↓	Serie		48.0	Total		48.0
21:	10.1	↘																																								
22:	*10.7	↗																																								
23:	9.8	↘																																								
24:	10.1	←																																								
Serie		39.0																																								
Total		0.0																																								
1:	*10.4	←																																								
2:	9.7	↓																																								
3:	*10.3	↗																																								
4:	9.7	↓																																								
5:	10.1	↓																																								
Serie		48.0																																								
Total		48.0																																								

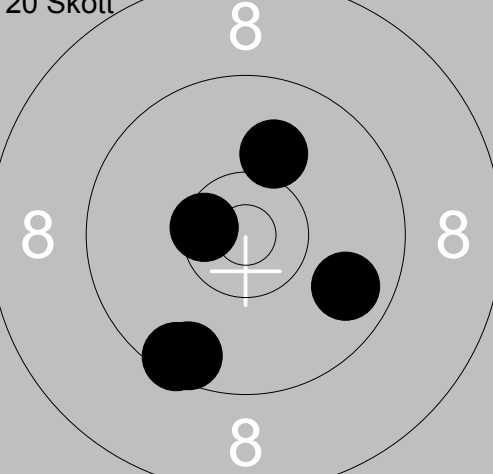
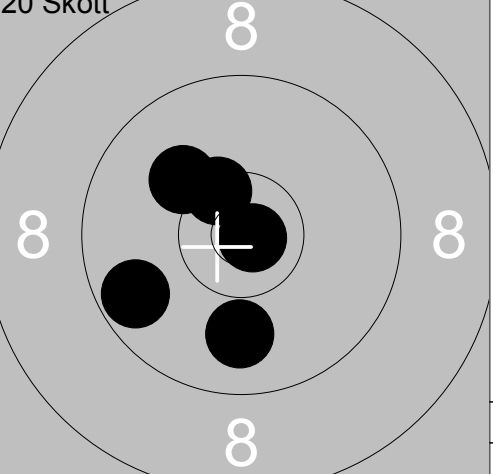
	<table border="1" style="width:100%; border-collapse: collapse;"> <tr><td>6:</td><td>9.8</td><td>↘</td></tr> <tr><td>7:</td><td>*10.5</td><td>←</td></tr> <tr><td>8:</td><td>9.5</td><td>↘</td></tr> <tr><td>9:</td><td>10.1</td><td>↗</td></tr> <tr><td>10:</td><td>9.6</td><td>↘</td></tr> <tr><td colspan="2">Serie</td><td style="text-align: right;">47.0</td></tr> <tr><td colspan="2">Total</td><td style="text-align: right;">95.0</td></tr> </table>	6:	9.8	↘	7:	*10.5	←	8:	9.5	↘	9:	10.1	↗	10:	9.6	↘	Serie		47.0	Total		95.0		<table border="1" style="width:100%; border-collapse: collapse;"> <tr><td>11:</td><td>10.1</td><td>↖</td></tr> <tr><td>12:</td><td>9.7</td><td>←</td></tr> <tr><td>13:</td><td>*10.4</td><td>↗</td></tr> <tr><td>14:</td><td>9.9</td><td>↓</td></tr> <tr><td>15:</td><td>*10.8</td><td>→</td></tr> <tr><td colspan="2">Serie</td><td style="text-align: right;">48.0</td></tr> <tr><td colspan="2">Total</td><td style="text-align: right;">143.0</td></tr> </table>	11:	10.1	↖	12:	9.7	←	13:	*10.4	↗	14:	9.9	↓	15:	*10.8	→	Serie		48.0	Total		143.0
6:	9.8	↘																																											
7:	*10.5	←																																											
8:	9.5	↘																																											
9:	10.1	↗																																											
10:	9.6	↘																																											
Serie		47.0																																											
Total		95.0																																											
11:	10.1	↖																																											
12:	9.7	←																																											
13:	*10.4	↗																																											
14:	9.9	↓																																											
15:	*10.8	→																																											
Serie		48.0																																											
Total		143.0																																											

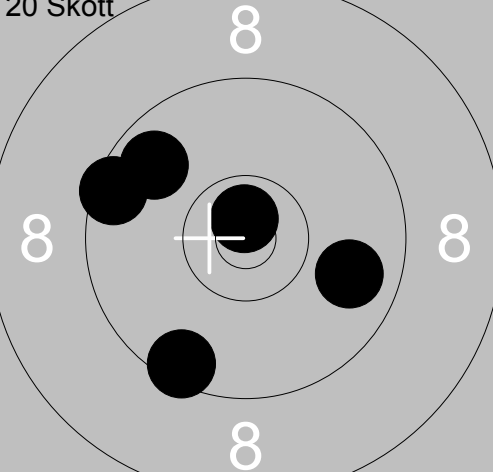
	<table border="1" style="width:100%; border-collapse: collapse;"> <tr><td>16:</td><td>9.5</td><td>↓</td></tr> <tr><td>17:</td><td>9.7</td><td>↗</td></tr> <tr><td>18:</td><td>9.5</td><td>↖</td></tr> <tr><td>19:</td><td>9.8</td><td>↘</td></tr> <tr><td>20:</td><td>*10.7</td><td>↑</td></tr> <tr><td colspan="2">Serie</td><td style="text-align: right;">46.0</td></tr> <tr><td colspan="2">Total</td><td style="text-align: right;">189.0</td></tr> </table>	16:	9.5	↓	17:	9.7	↗	18:	9.5	↖	19:	9.8	↘	20:	*10.7	↑	Serie		46.0	Total		189.0		
16:	9.5	↓																						
17:	9.7	↗																						
18:	9.5	↖																						
19:	9.8	↘																						
20:	*10.7	↑																						
Serie		46.0																						
Total		189.0																						

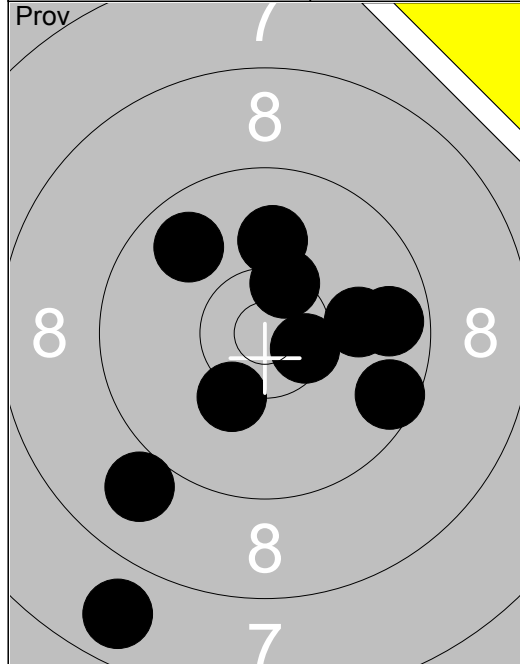

1:	*10.4	↗
2:	10.2	↘
3:	9.0	↙
4:	10.0	↑
5:	9.7	→
6:	9.8	↗
7:	10.0	→
8:	7.8	↘
9:	*10.5	→
10:	9.6	↘
Serie		93.0
Total		0.0

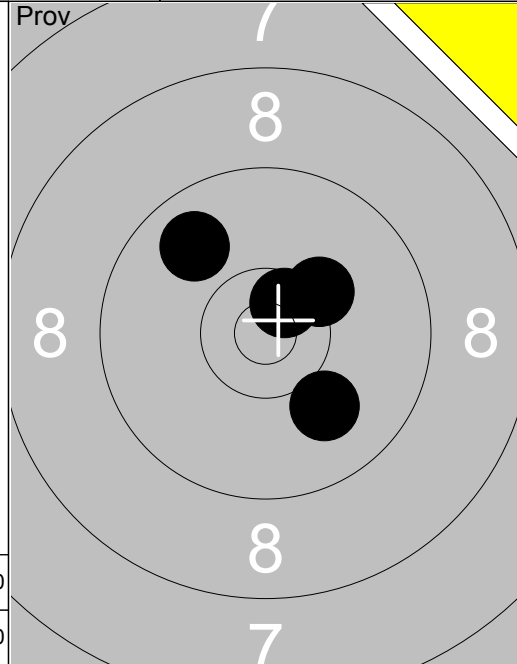

11:	10.0	↘
12:	*10.6	↗
13:	9.8	↖
14:	10.3	↗
Serie		39.0
Total		0.0

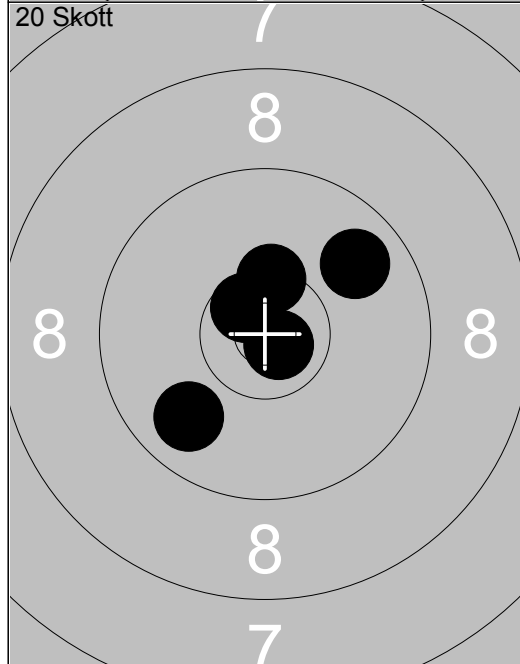

1:	*10.4	↑
2:	9.8	↗
3:	*10.8	↘
4:	*10.6	↖
5:	9.8	↙
Serie		48.0
Total		48.0

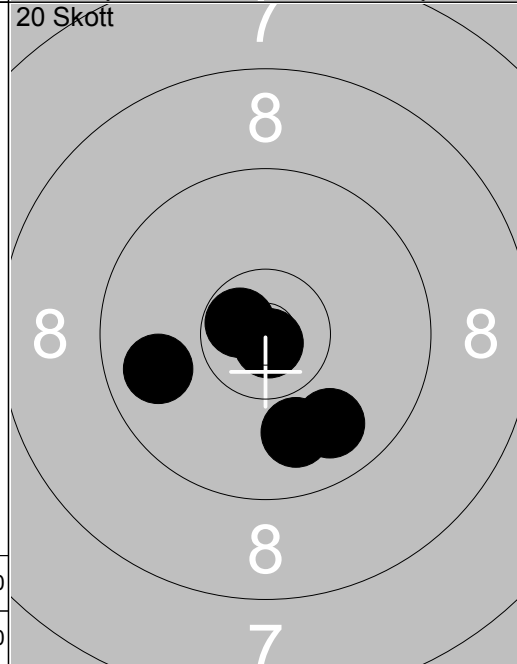

6:	9.9	↘
7:	*10.7	↖
8:	9.9	↘
9:	9.8	←
10:	*10.9	↘
Serie		47.0
Total		95.0

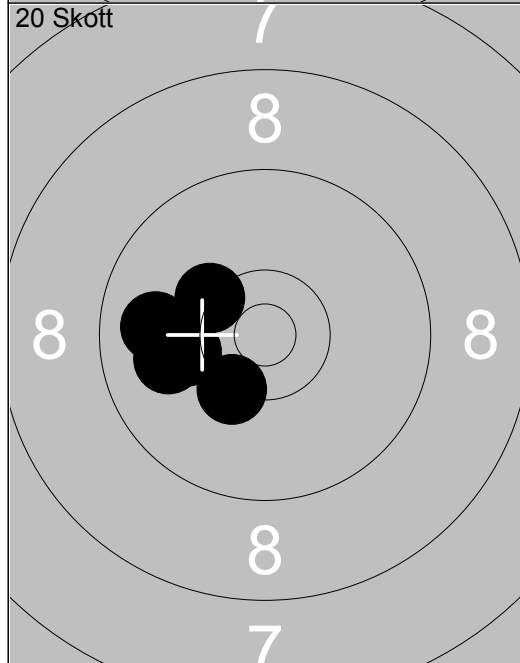

11:	9.9	←
12:	*10.3	↖
13:	10.1	←
14:	10.0	←
15:	*10.3	↘
Serie		49.0
Total		144.0

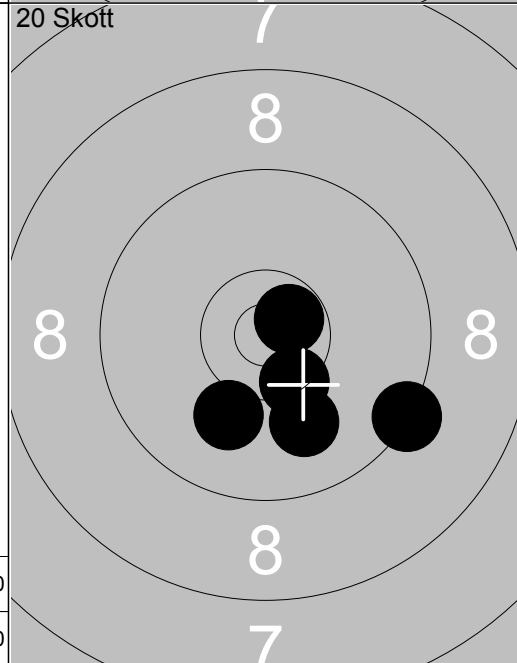

16:	*10.7	↗
17:	10.0	↘
18:	*10.4	↘
19:	9.3	↘
20:	10.1	↘
Serie		49.0
Total		193.0

<p>Prov</p>	<p>1: 7.5 ↙</p> <p>2: *10.4 ↗</p> <p>3: 8.4 ↗</p> <p>4: *10.5 ↗</p> <p>5: 8.9 ↗</p> <p>6: 9.7 →</p> <p>7: *10.3 ↗</p> <p>8: 9.6 ↗</p> <p>9: 9.5 →</p> <p>10: *10.5 ↑</p>	<p>Prov</p>	<p>11: *10.8 ↗</p>																
<table style="width:100%; border-collapse: collapse;"> <tr> <td style="width:50%;">Serie</td> <td style="text-align: right;">90.0</td> <td style="width:50%;">Serie</td> <td style="text-align: right;">10.0</td> </tr> <tr> <td>Total</td> <td style="text-align: right;">0.0</td> <td>Total</td> <td style="text-align: right;">0.0</td> </tr> </table>	Serie	90.0	Serie	10.0	Total	0.0	Total	0.0		<table style="width:100%; border-collapse: collapse;"> <tr> <td style="width:50%;">Serie</td> <td style="text-align: right;">90.0</td> <td style="width:50%;">Serie</td> <td style="text-align: right;">10.0</td> </tr> <tr> <td>Total</td> <td style="text-align: right;">0.0</td> <td>Total</td> <td style="text-align: right;">0.0</td> </tr> </table>	Serie	90.0	Serie	10.0	Total	0.0	Total	0.0	
Serie	90.0	Serie	10.0																
Total	0.0	Total	0.0																
Serie	90.0	Serie	10.0																
Total	0.0	Total	0.0																

<p>20 Skott</p>	<p>1: 9.2 →</p> <p>2: 7.5 ↑</p> <p>3: *10.4 →</p> <p>4: 10.2 →</p> <p>5: 8.7 ↘</p>	<p>20 Skott</p>	<p>6: 9.3 ↑</p> <p>7: 10.2 ↗</p> <p>8: 10.1 →</p> <p>9: 9.3 →</p> <p>10: 8.6 →</p>																
<table style="width:100%; border-collapse: collapse;"> <tr> <td style="width:50%;">Serie</td> <td style="text-align: right;">44.0</td> <td style="width:50%;">Serie</td> <td style="text-align: right;">46.0</td> </tr> <tr> <td>Total</td> <td style="text-align: right;">44.0</td> <td>Total</td> <td style="text-align: right;">90.0</td> </tr> </table>	Serie	44.0	Serie	46.0	Total	44.0	Total	90.0		<table style="width:100%; border-collapse: collapse;"> <tr> <td style="width:50%;">Serie</td> <td style="text-align: right;">44.0</td> <td style="width:50%;">Serie</td> <td style="text-align: right;">46.0</td> </tr> <tr> <td>Total</td> <td style="text-align: right;">44.0</td> <td>Total</td> <td style="text-align: right;">90.0</td> </tr> </table>	Serie	44.0	Serie	46.0	Total	44.0	Total	90.0	
Serie	44.0	Serie	46.0																
Total	44.0	Total	90.0																
Serie	44.0	Serie	46.0																
Total	44.0	Total	90.0																

<p>20 Skott</p>	<p>11: 9.0 →</p> <p>12: 9.0 →</p> <p>13: *10.6 ↓</p> <p>14: 9.8 ↗</p> <p>15: *10.6 →</p>	<p>20 Skott</p>	<p>16: *10.7 ↙</p> <p>17: 8.7 ↗</p> <p>18: *10.3 ↓</p> <p>19: *10.3 ↓</p> <p>20: 9.9 ↘</p>																
<table style="width:100%; border-collapse: collapse;"> <tr> <td style="width:50%;">Serie</td> <td style="text-align: right;">47.0</td> <td style="width:50%;">Serie</td> <td style="text-align: right;">47.0</td> </tr> <tr> <td>Total</td> <td style="text-align: right;">137.0</td> <td>Total</td> <td style="text-align: right;">184.0</td> </tr> </table>	Serie	47.0	Serie	47.0	Total	137.0	Total	184.0		<table style="width:100%; border-collapse: collapse;"> <tr> <td style="width:50%;">Serie</td> <td style="text-align: right;">47.0</td> <td style="width:50%;">Serie</td> <td style="text-align: right;">47.0</td> </tr> <tr> <td>Total</td> <td style="text-align: right;">137.0</td> <td>Total</td> <td style="text-align: right;">184.0</td> </tr> </table>	Serie	47.0	Serie	47.0	Total	137.0	Total	184.0	
Serie	47.0	Serie	47.0																
Total	137.0	Total	184.0																
Serie	47.0	Serie	47.0																
Total	137.0	Total	184.0																

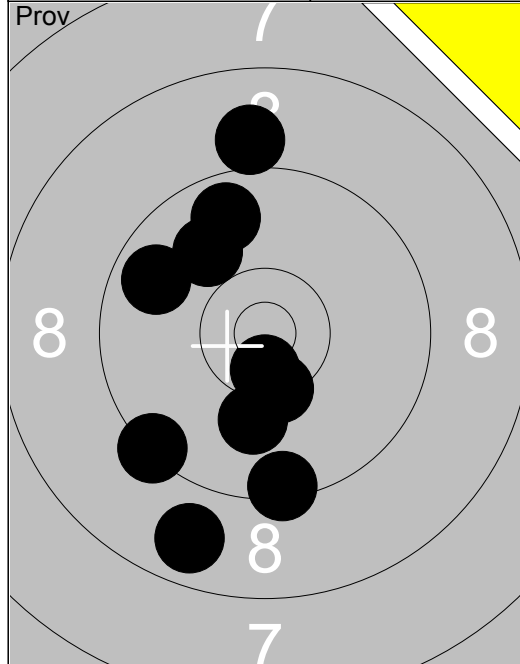

1:	9.0	↑
2:	8.8	↓
3:	*10.4	↓
4:	9.7	↑
5:	10.0	↑
6:	9.7	↖
7:	9.3	↙
8:	9.4	↓
9:	*10.6	↓
10:	10.1	↓
Serie		93.0
Total		0.0

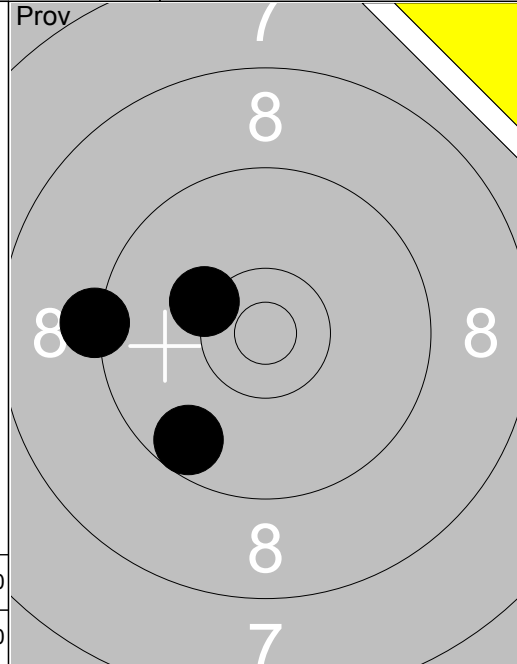

11:	9.6	↘
12:	9.2	←
13:	10.3	↖
Serie		28.0
Total		0.0

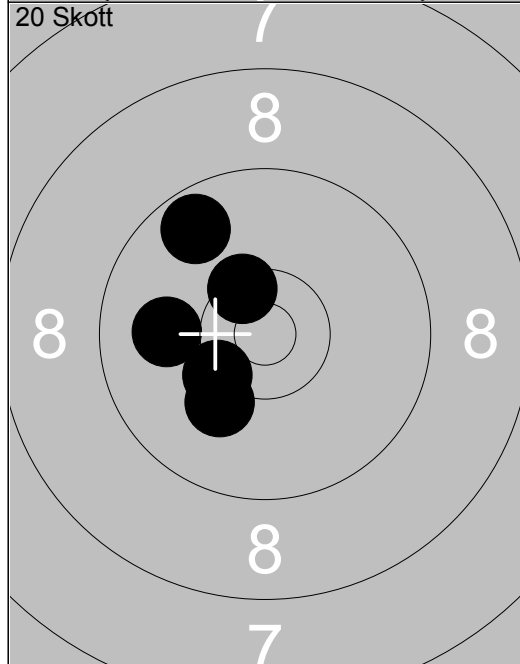

1:	10.1	↘
2:	10.0	←
3:	9.7	↖
4:	*10.3	↙
5:	*10.4	↖
Serie		49.0
Total		49.0

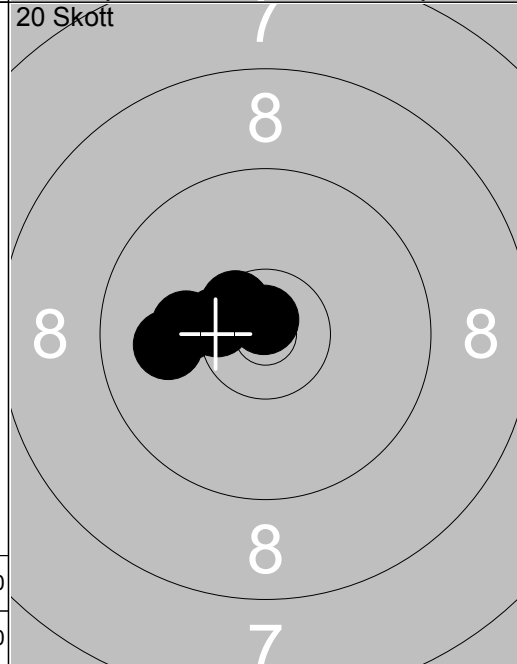

6:	*10.5	↖
7:	*10.5	←
8:	10.2	←
9:	*10.8	↑
10:	10.0	←
Serie		50.0
Total		99.0

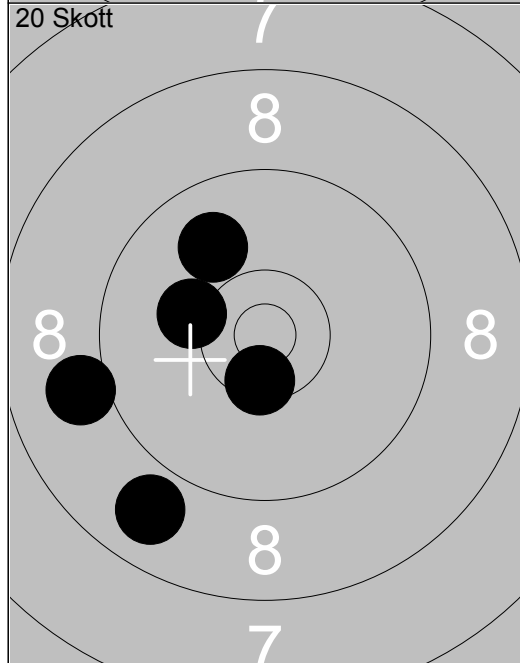

11:	8.9	↘
12:	10.2	←
13:	9.9	↖
14:	9.0	←
15:	*10.5	↓
Serie		46.0
Total		145.0

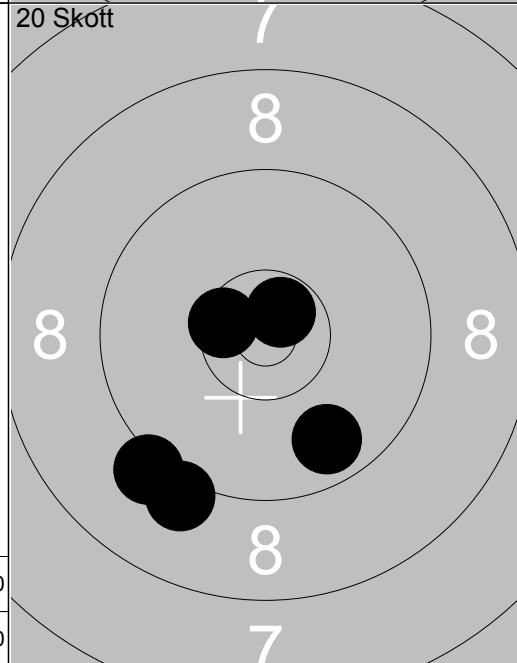

16:	*10.7	↗
17:	9.2	↘
18:	9.7	↓
19:	*10.5	←
20:	9.1	↘
Serie		47.0
Total		192.0

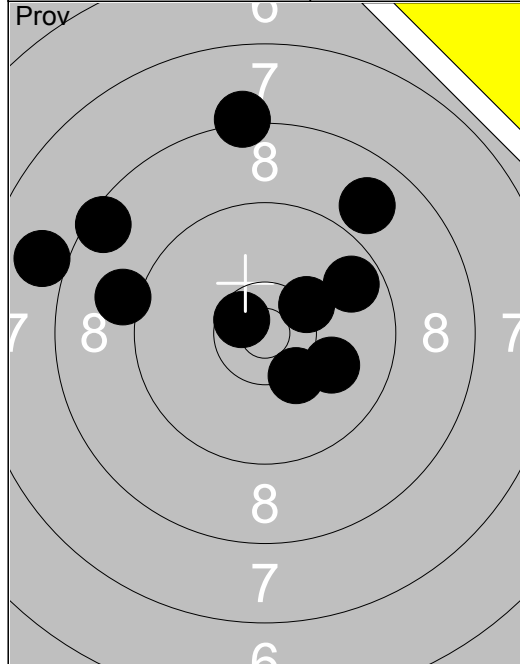

1:	9.1	↙
2:	8.0	↙
3:	8.2	↑
4:	8.5	↗
5:	*10.3	↗
6:	*10.6	↙
7:	8.9	↗
8:	9.7	↗
9:	10.0	↘
10:	10.3	↘
Serie		90.0
Total		0.0

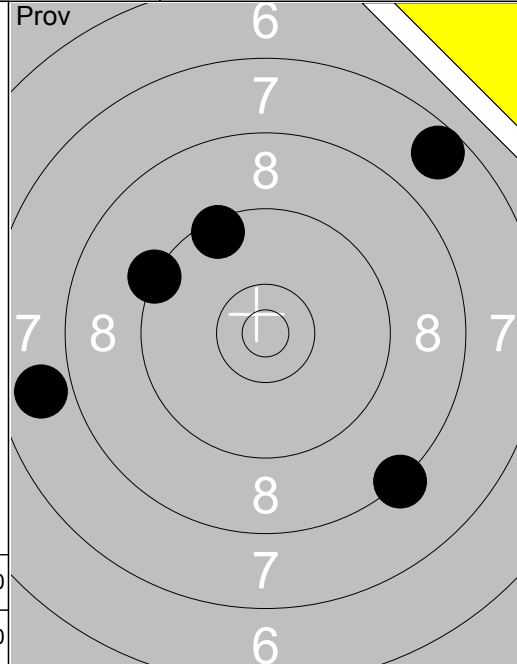

11:	8.3	↘
12:	7.6	↗
13:	9.5	↗
14:	7.9	↙
15:	9.3	↙
Serie		40.0
Total		0.0

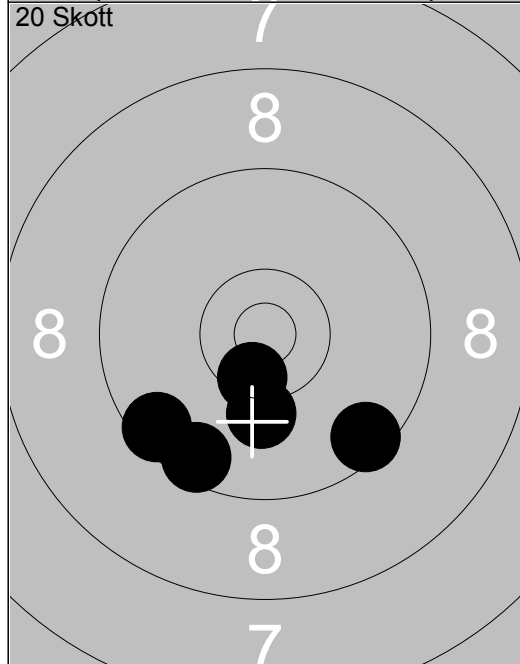

1:	9.5	↘
2:	10.2	↓
3:	*10.5	↓
4:	9.5	↓
5:	9.5	↙
Serie		47.0
Total		47.0

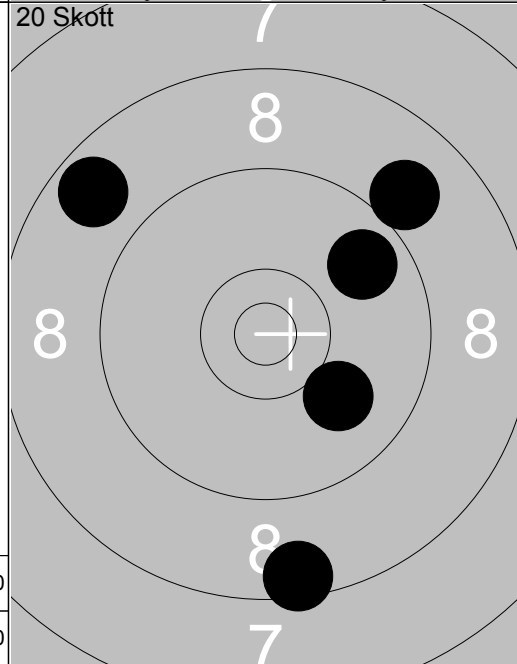

6:	9.8	↗
7:	10.0	↘
8:	9.0	↗
9:	8.7	↖
10:	8.5	↓
Serie		44.0
Total		91.0

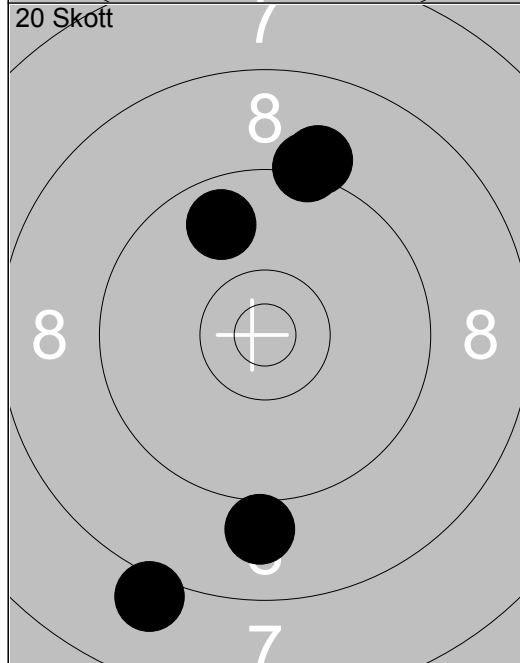

11:	9.1	↗
12:	9.0	↓
13:	9.2	↗
14:	9.8	↗
15:	8.1	↘
Serie		44.0
Total		135.0

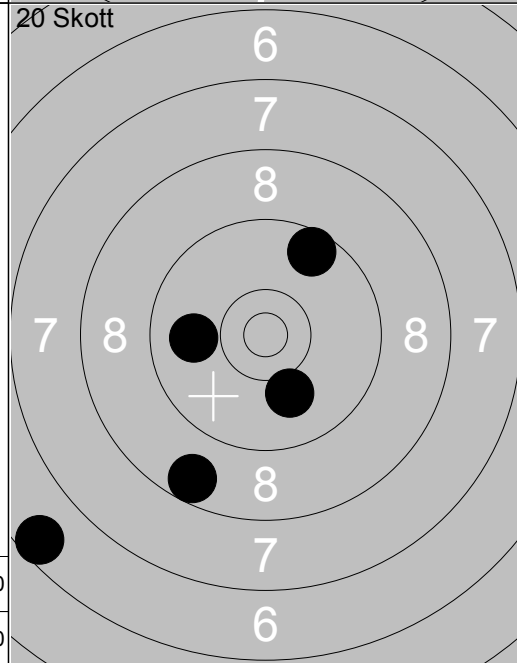

16:	8.6	↘
17:	10.0	↘
18:	9.9	↙
19:	9.6	↗
20:	6.6	↙
Serie		42.0
Total		177.0

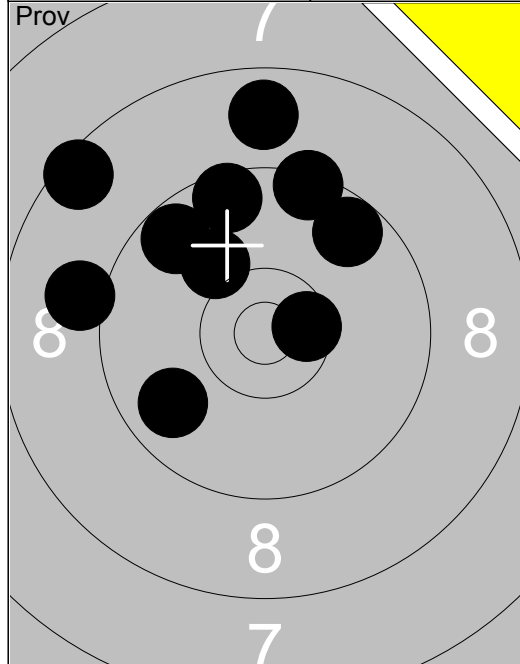

1:	9.1	←
2:	8.5	↗
3:	9.8	↙
4:	8.8	↑
5:	9.5	↑
6:	9.4	↑
7:	9.6	↗
8:	9.7	↗
9:	10.1	↗
10:	*10.5	→
Serie		90.0
Total		0.0

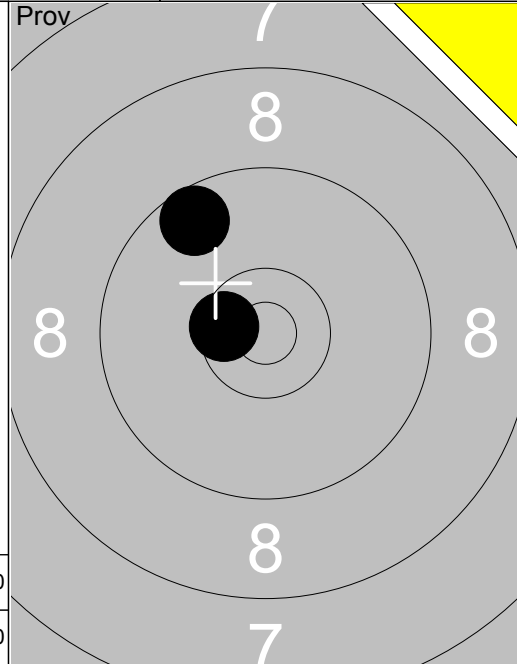

11:	9.6	↗
12:	*10.5	←
Serie		19.0
Total		0.0

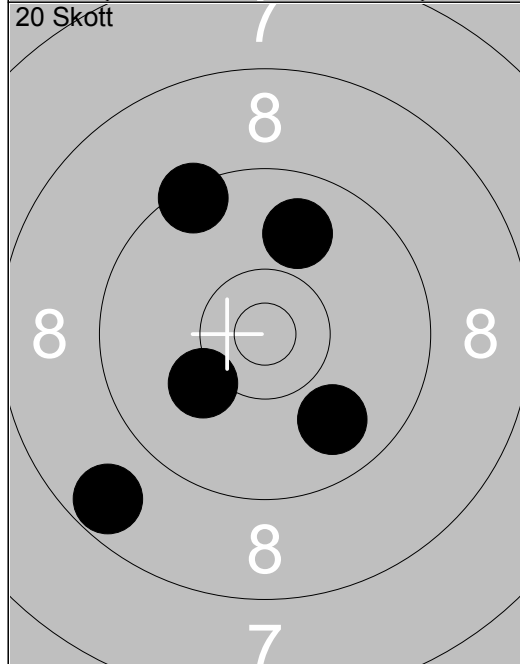

1:	8.7	↙
2:	9.9	↘
3:	9.9	↑
4:	10.2	↙
5:	9.4	↑
Serie		45.0
Total		45.0

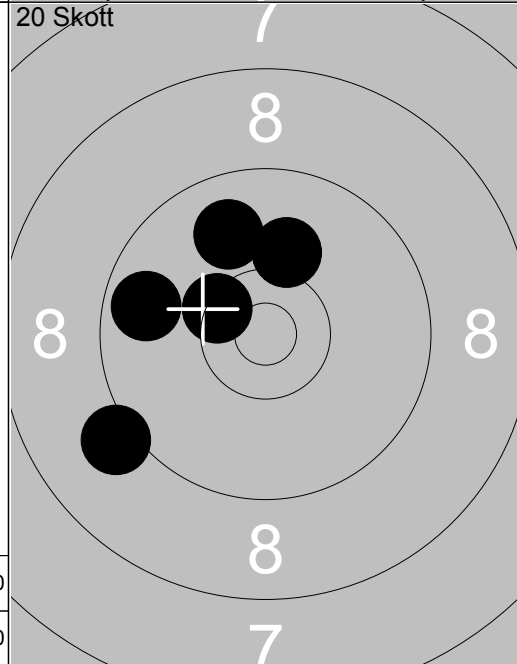

6:	*10.4	↙
7:	10.1	↑
8:	9.7	←
9:	9.9	↑
10:	9.1	↙
Serie		47.0
Total		92.0

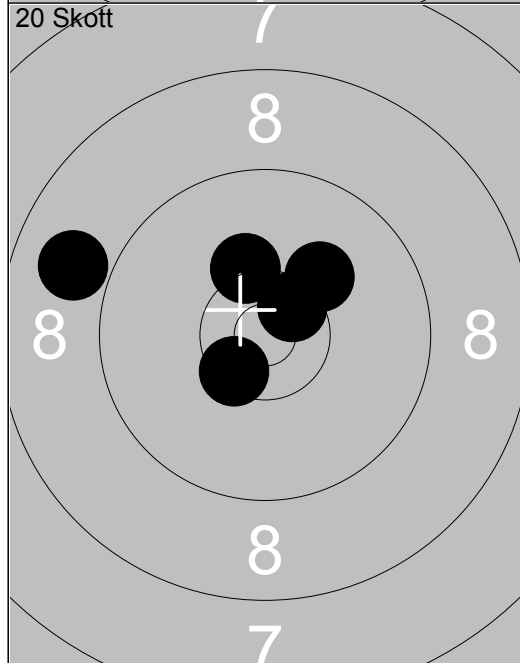

11:	*10.5	↙
12:	10.3	↑
13:	8.9	←
14:	10.2	↗
15:	*10.6	↗
Serie		48.0
Total		140.0

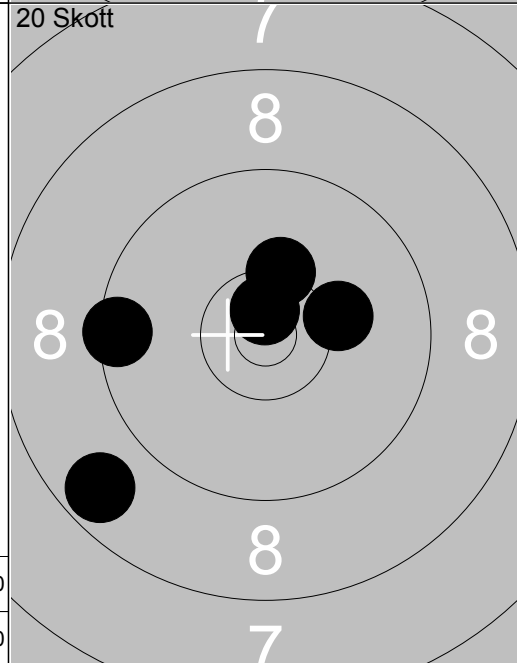

16:	8.7	↙
17:	9.5	←
18:	10.2	→
19:	*10.7	↑
20:	*10.3	↑
Serie		47.0
Total		187.0

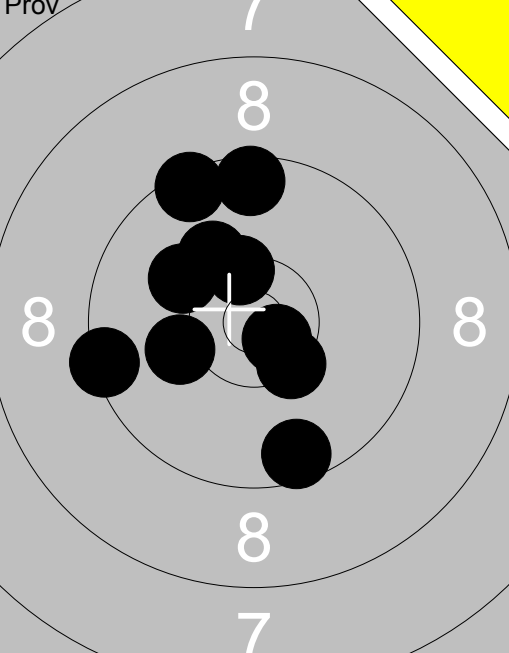
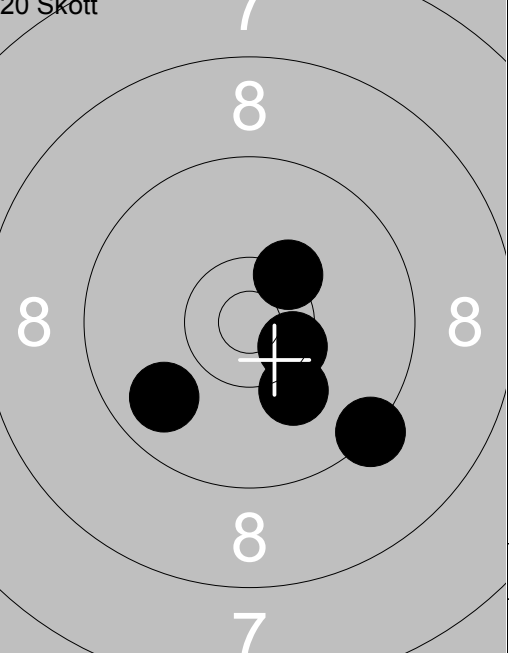
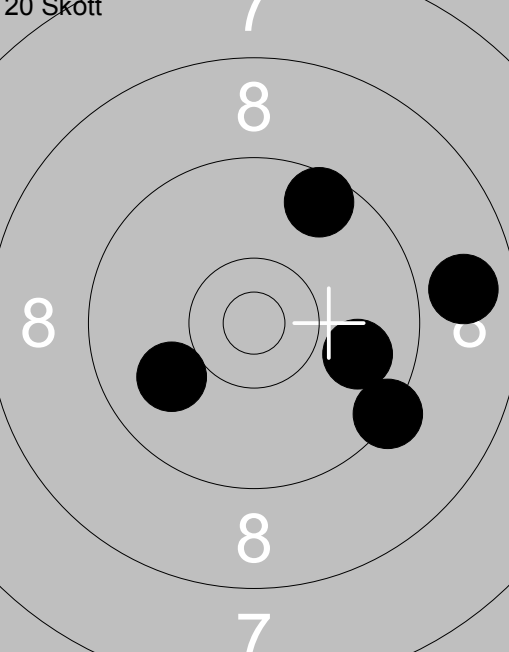
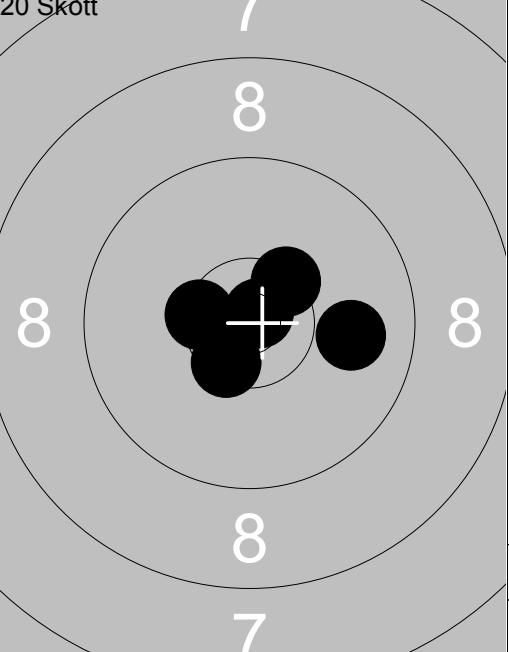
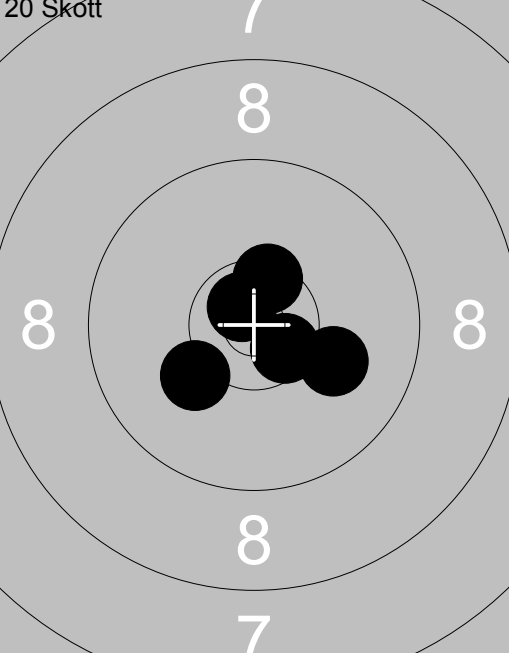

Prov 	1: 9.5 ↑ 2: 9.4 ← 3: *10.4 ↑ 4: 10.2 ↗ 5: 9.5 ↑ 6: 10.1 ↗ 7: 9.6 ↓ 8: *10.4 ↓ 9: 10.2 ← 10: *10.7 ↓ <hr/> Serie 96.0 Total 0.0	20 Skott 	1: 9.3 ↓ 2: *10.3 ↗ 3: 10.1 ↓ 4: 9.8 ← 5: *10.5 ↓ <hr/> Serie 48.0 Total 48.0
20 Skott 	6: 9.3 ↓ 7: 10.0 ← 8: 9.6 ↗ 9: 8.8 → 10: 9.9 → <hr/> Serie 45.0 Total 93.0	20 Skott 	11: *10.5 ↙ 12: *10.8 ↗ 13: 9.9 → 14: *10.4 ↗ 15: *10.4 ← <hr/> Serie 49.0 Total 142.0
20 Skott 	16: 10.2 ↙ 17: 10.1 → 18: *10.7 ↗ 19: *10.5 ↑ 20: *10.6 ↓ <hr/> Serie 50.0 Total 192.0		

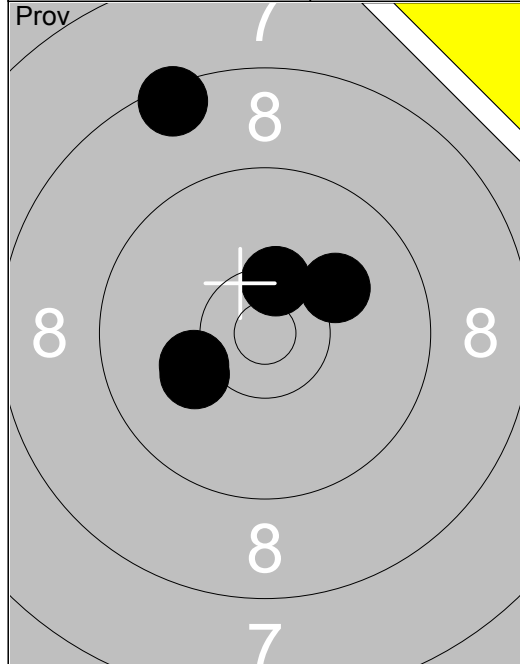

1:	*10.4	↗
2:	10.1	↖
3:	8.5	↗
4:	10.1	↗
5:	10.2	↖
Serie		48.0
Total		0.0

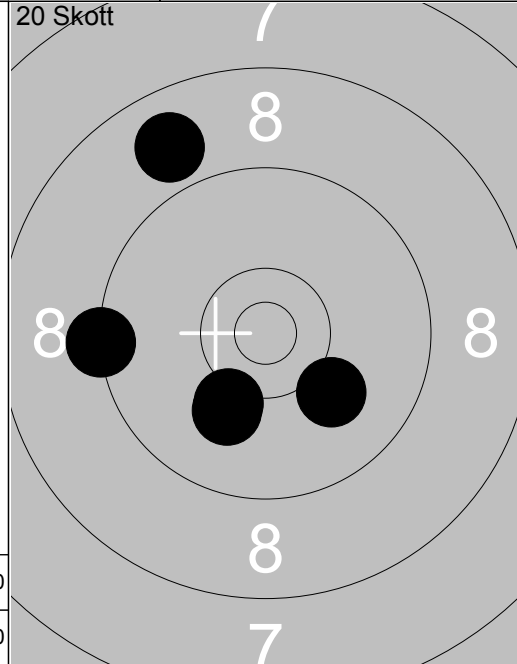

1:	9.3	↖
2:	8.9	↗
3:	10.1	↘
4:	10.1	↘
5:	10.2	↘
Serie		47.0
Total		47.0

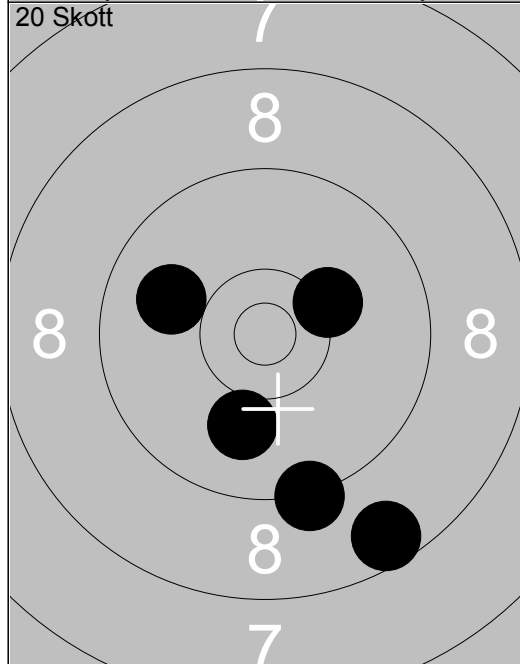

6:	9.3	↘
7:	8.6	↘
8:	10.0	↘
9:	10.0	↖
10:	10.2	↗
Serie		47.0
Total		94.0

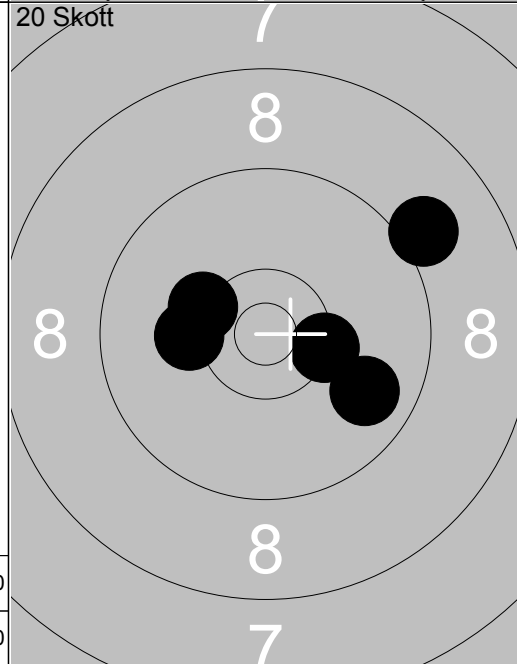

11:	10.3	↖
12:	*10.3	↗
13:	10.2	↖
14:	9.1	↗
15:	9.8	↘
Serie		48.0
Total		142.0

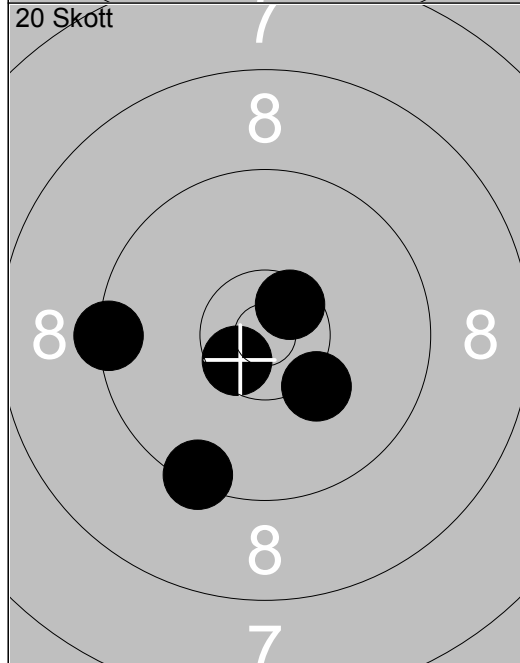

16:	10.2	↘
17:	9.4	↘
18:	9.4	↖
19:	*10.6	↖
20:	*10.6	↗
Serie		48.0
Total		190.0

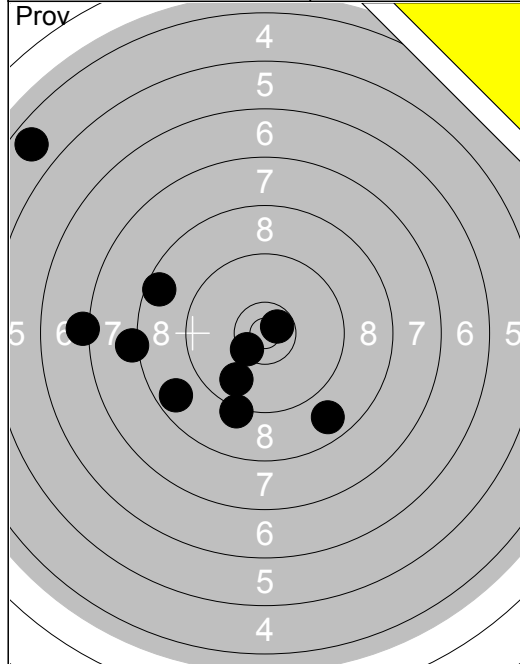

1:	4.7	↖
2:	8.2	←
3:	8.8	↘
4:	*10.4	↙
5:	9.8	↘
6:	7.2	←
7:	8.7	↙
8:	9.2	↘
9:	*10.7	↗
10:	8.6	←
Serie		81.0
Total		0.0

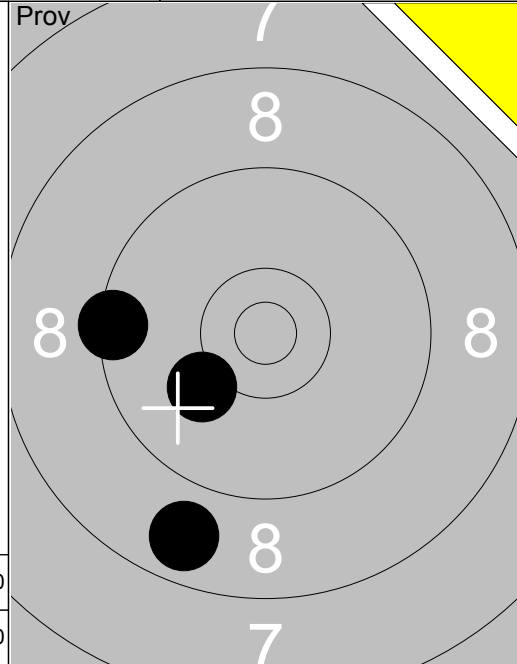

11:	8.8	↘
12:	10.1	↙
13:	9.4	←
Serie		27.0
Total		0.0

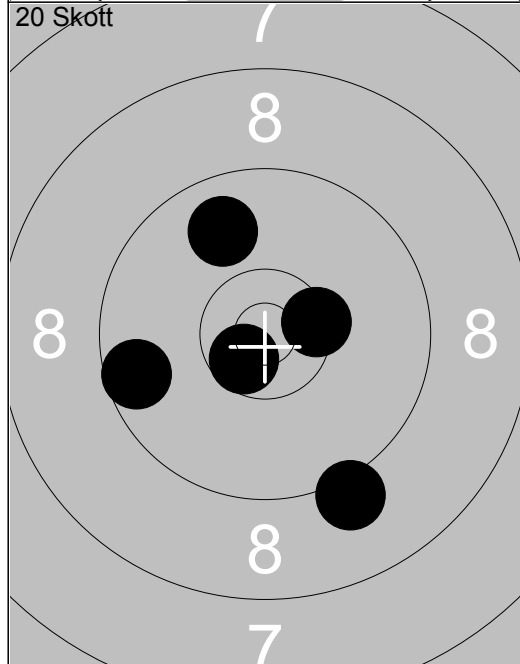

1:	*10.6	↘
2:	9.6	←
3:	9.1	↘
4:	*10.4	↗
5:	9.8	↗
Serie		47.0
Total		47.0

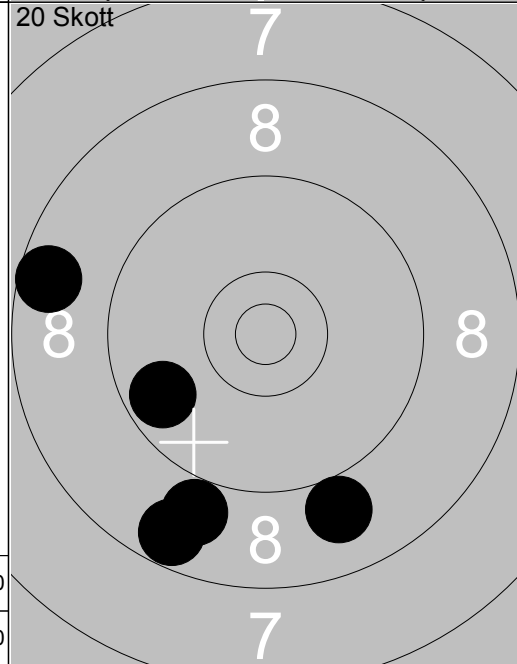

6:	8.9	↘
7:	9.0	↘
8:	8.7	↘
9:	9.7	↙
10:	8.6	←
Serie		42.0
Total		89.0

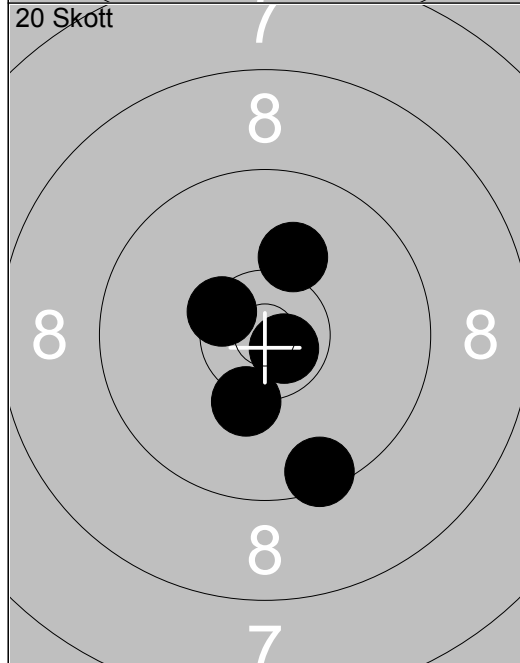

11:	*10.7	↘
12:	9.5	↘
13:	10.1	↗
14:	10.3	↘
15:	*10.5	↙
Serie		49.0
Total		138.0

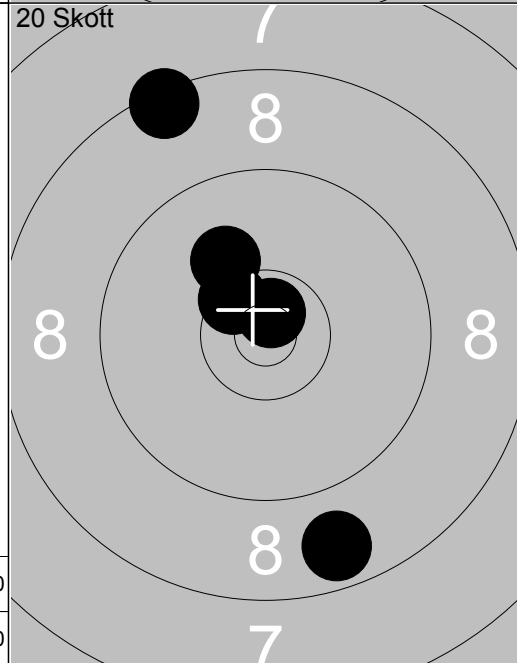

16:	*10.5	↖
17:	8.4	↗
18:	*10.7	↗
19:	8.7	↘
20:	10.1	↖
Serie		46.0
Total		184.0

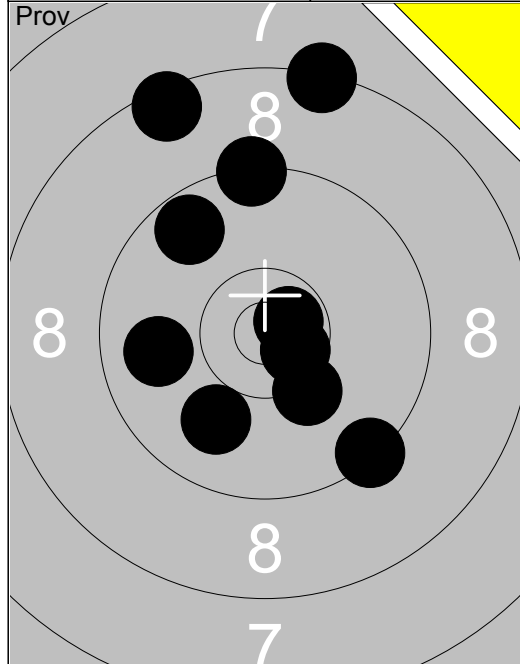

1:	8.3	↑
2:	8.5	↑
3:	9.3	↑
4:	9.9	←
5:	9.4	↓
6:	9.7	↑
7:	*10.6	↓
8:	*10.7	↗
9:	10.2	↓
10:	10.0	↘
Serie		92.0
Total		0.0

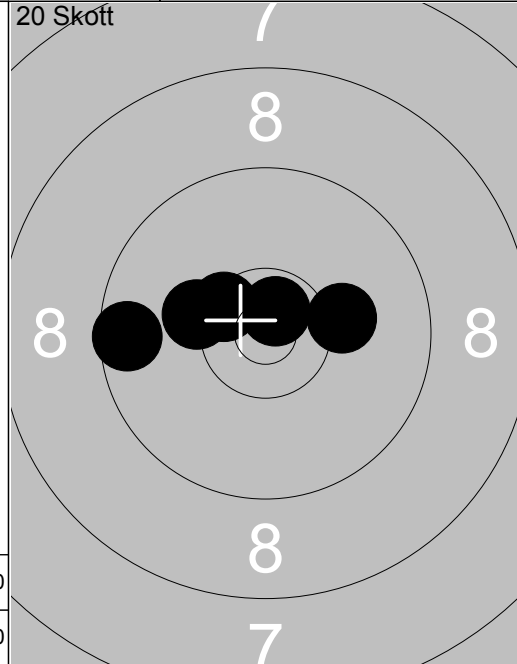

1:	10.2	←
2:	10.2	→
3:	9.6	←
4:	*10.7	↑
5:	*10.5	↖
Serie		49.0
Total		49.0

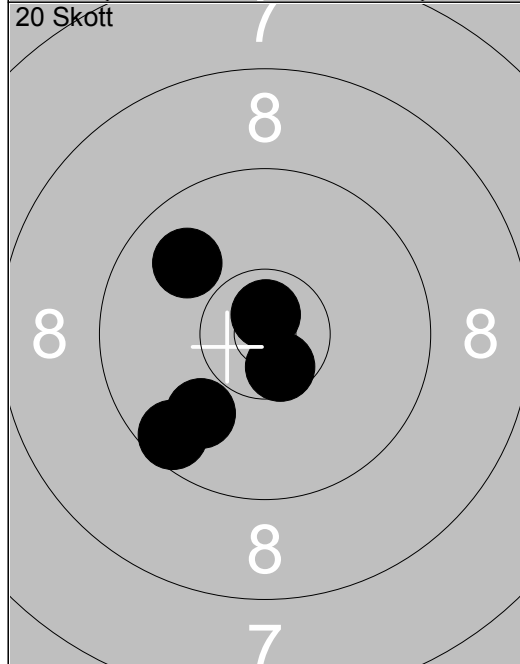

6:	*10.6	↓
7:	9.6	↘
8:	9.9	↘
9:	*10.8	↑
10:	9.9	↖
Serie		47.0
Total		96.0

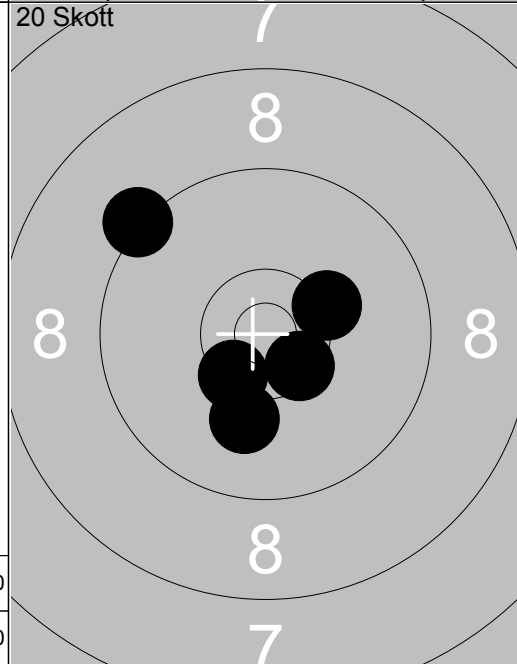

11:	10.1	↓
12:	*10.4	↘
13:	*10.5	↘
14:	10.3	↗
15:	9.3	↖
Serie		49.0
Total		145.0

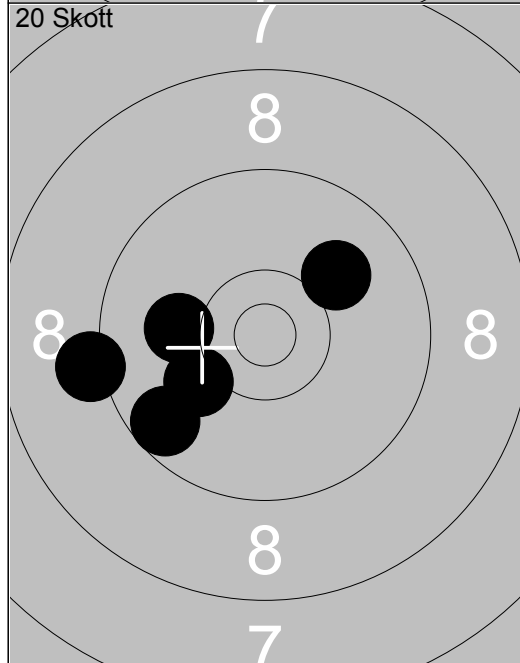

16:	10.0	↗
17:	10.1	←
18:	9.2	←
19:	10.1	↘
20:	9.6	↘
Serie		48.0
Total		193.0

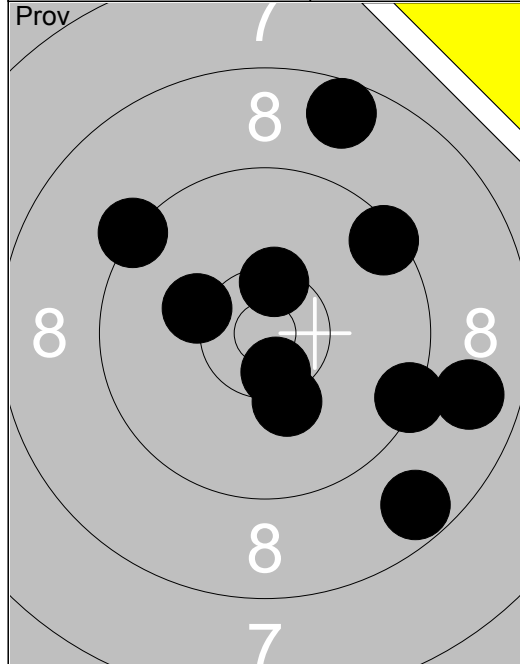

1:	9.3	↖
2:	8.6	↑
3:	9.4	↗
4:	10.2	↓
5:	8.8	→
6:	*10.5	↓
7:	9.4	↘
8:	8.7	↓
9:	10.2	↖
10:	*10.4	↑
Serie		91.0
Total		0.0

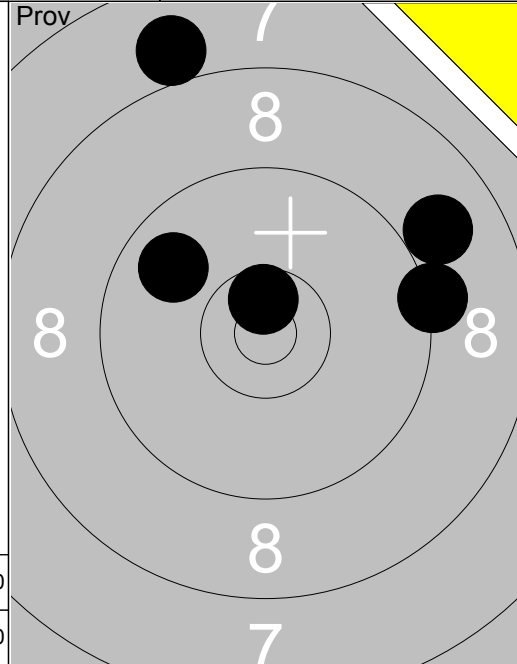

11:	9.8	↖
12:	9.2	→
13:	8.0	↑
14:	8.9	↗
15:	*10.6	↑
Serie		44.0
Total		0.0

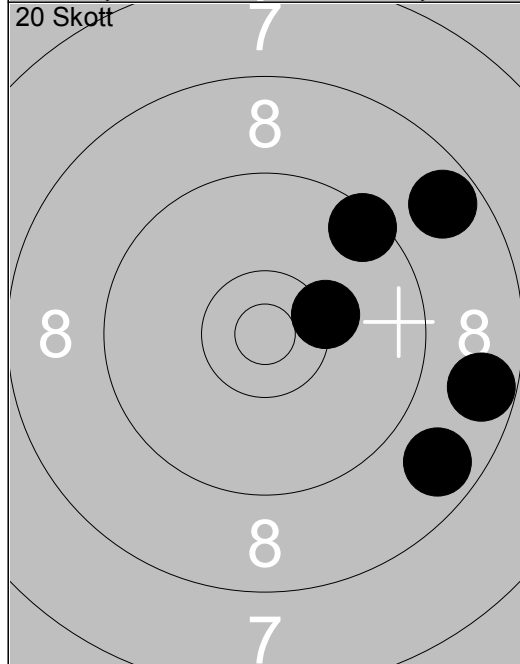

1:	8.8	↘
2:	8.7	↗
3:	9.5	↗
4:	8.7	→
5:	*10.3	→
Serie		43.0
Total		43.0

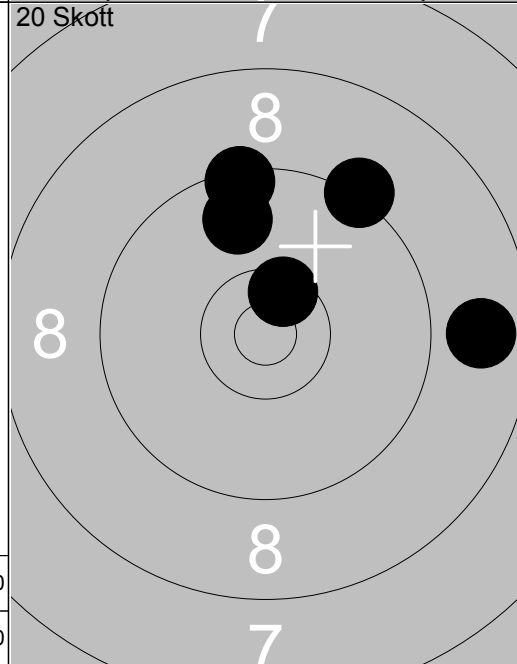

6:	8.8	→
7:	9.8	↑
8:	9.3	↗
9:	9.4	↑
10:	*10.5	↑
Serie		45.0
Total		88.0

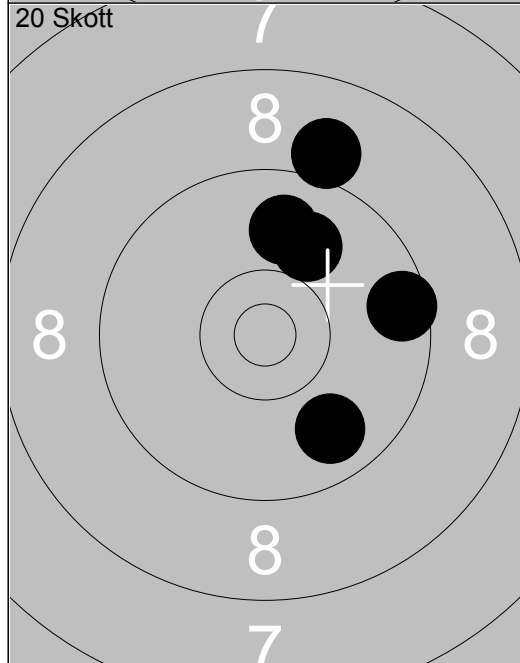

11:	9.0	↑
12:	9.8	↓
13:	10.0	↑
14:	9.6	→
15:	9.9	↑
Serie		46.0
Total		134.0

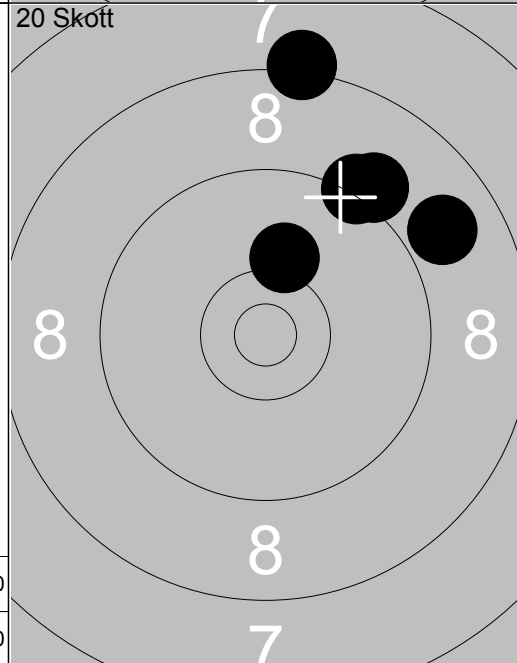

16:	8.9	↗
17:	9.1	↗
18:	10.2	↑
19:	9.2	↗
20:	8.2	↑
Serie		44.0
Total		178.0

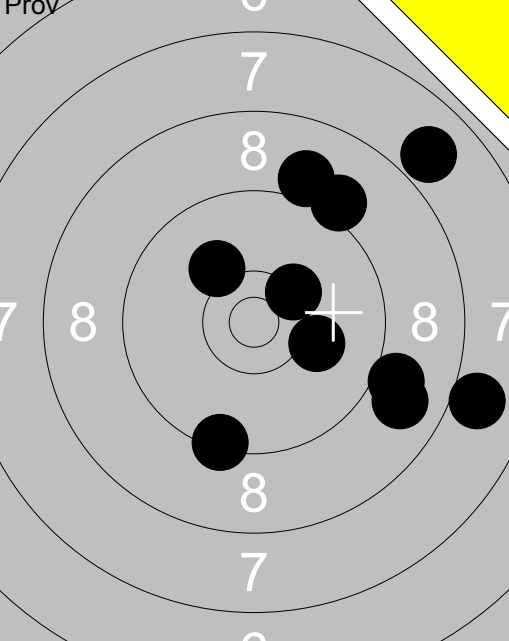
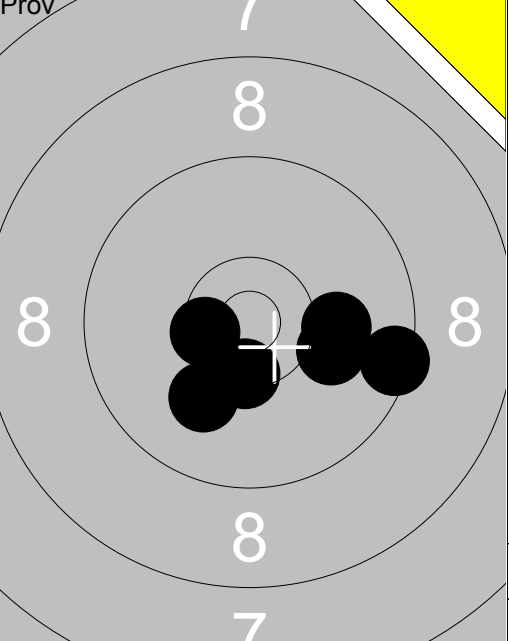
<p>Prov</p> 	<p>1: 7.9 ↗</p> <p>2: *10.3 ↗</p> <p>3: 9.1 ↗</p> <p>4: 9.0 →</p> <p>5: 10.1 →</p> <p>6: 9.4 ↓</p> <p>7: 10.1 ↗</p> <p>8: 8.9 →</p> <p>9: 9.0 ↗</p> <p>10: 8.0 →</p> <hr/> <p>Serie 89.0</p> <hr/> <p>Total 0.0</p>	<p>Prov</p> 	<p>11: 9.5 →</p> <p>12: 10.1 →</p> <p>13: 10.1 →</p> <p>14: *10.5 ←</p> <p>15: *10.4 ↓</p> <p>16: 10.1 ↘</p> <hr/> <p>Serie 59.0</p> <hr/> <p>Total 0.0</p>
--	---	--	---

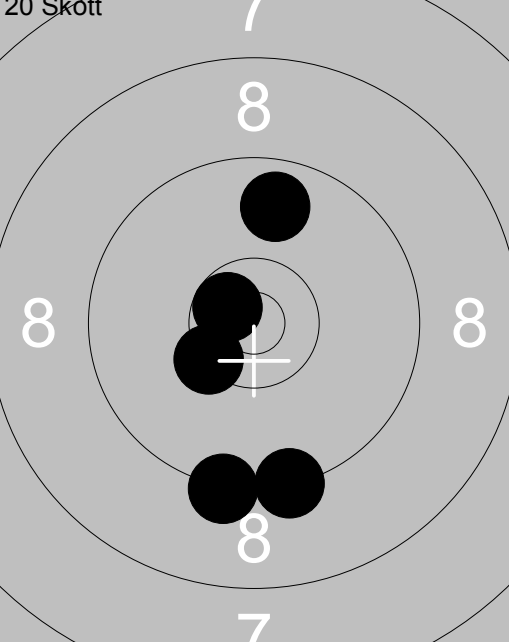
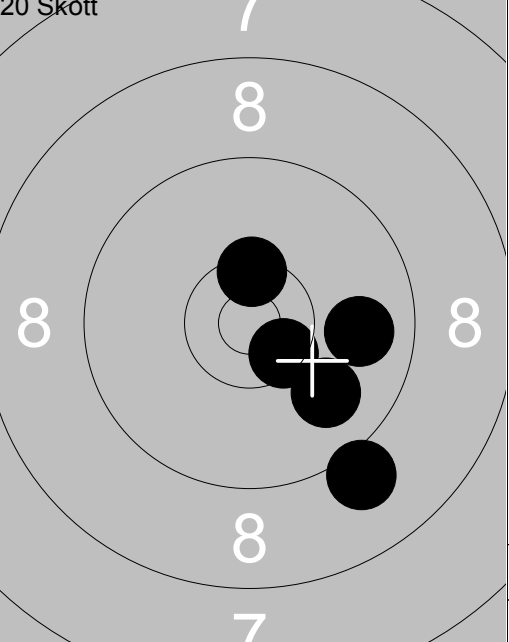
<p>20 Skott</p> 	<p>1: 9.3 ↓</p> <p>2: 9.3 ↓</p> <p>3: *10.4 ↙</p> <p>4: *10.6 ↙</p> <p>5: 9.8 ↑</p> <hr/> <p>Serie 47.0</p> <hr/> <p>Total 47.0</p>	<p>20 Skott</p> 	<p>6: 9.1 ↘</p> <p>7: *10.5 ↘</p> <p>8: *10.4 ↑</p> <p>9: 9.9 →</p> <p>10: 9.9 ↘</p> <hr/> <p>Serie 47.0</p> <hr/> <p>Total 94.0</p>
---	---	---	--

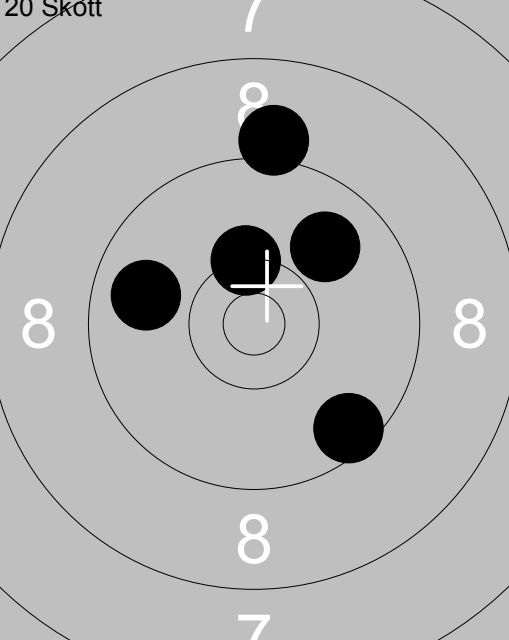
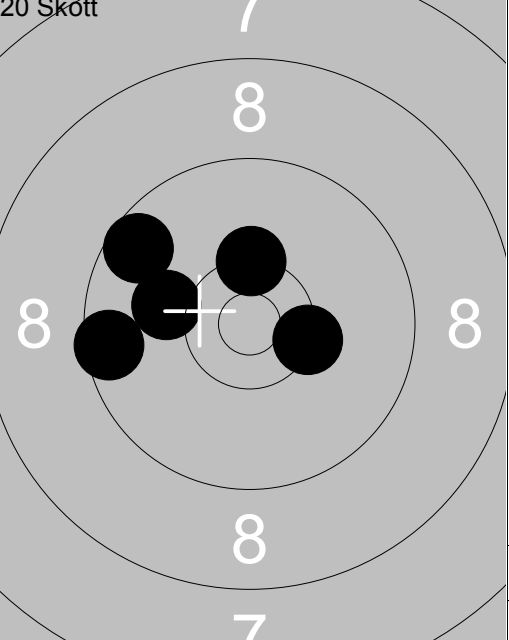
<p>20 Skott</p> 	<p>11: 9.9 ↗</p> <p>12: 9.1 ↑</p> <p>13: *10.3 ↑</p> <p>14: 9.8 ←</p> <p>15: 9.5 ↘</p> <hr/> <p>Serie 46.0</p> <hr/> <p>Total 140.0</p>	<p>20 Skott</p> 	<p>16: 9.5 ←</p> <p>17: 10.1 ←</p> <p>18: *10.3 ↑</p> <p>19: *10.4 →</p> <p>20: 9.6 ↗</p> <hr/> <p>Serie 48.0</p> <hr/> <p>Total 188.0</p>
--	---	--	--

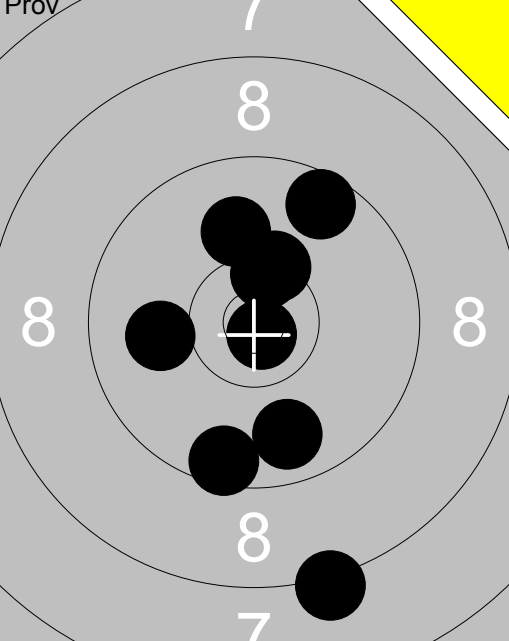
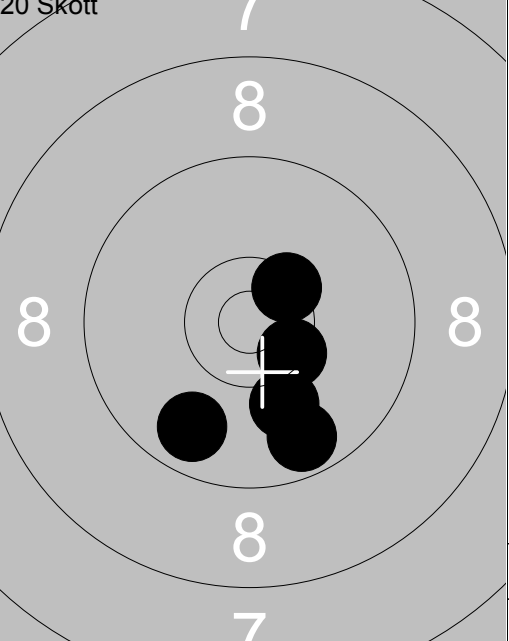
Prov 	20 Skott 	<table style="width:100%; border-collapse: collapse;"> <tr><td>1: 9.8</td><td style="text-align: right;">↓</td></tr> <tr><td>2: 10.0</td><td style="text-align: right;">←</td></tr> <tr><td>3: *10.5</td><td style="text-align: right;">↑</td></tr> <tr><td>4: 10.0</td><td style="text-align: right;">↑</td></tr> <tr><td>5: 9.6</td><td style="text-align: right;">↗</td></tr> <tr><td>6: *10.4</td><td style="text-align: right;">↑</td></tr> <tr><td>7: *10.4</td><td style="text-align: right;">↑</td></tr> <tr><td>8: 8.2</td><td style="text-align: right;">↓</td></tr> <tr><td>9: 9.5</td><td style="text-align: right;">↓</td></tr> <tr><td>10: *10.8</td><td style="text-align: right;">↓</td></tr> <tr><td colspan="2">Serie 95.0</td></tr> <tr><td colspan="2">Total 0.0</td></tr> </table>	1: 9.8	↓	2: 10.0	←	3: *10.5	↑	4: 10.0	↑	5: 9.6	↗	6: *10.4	↑	7: *10.4	↑	8: 8.2	↓	9: 9.5	↓	10: *10.8	↓	Serie 95.0		Total 0.0	
1: 9.8	↓																									
2: 10.0	←																									
3: *10.5	↑																									
4: 10.0	↑																									
5: 9.6	↗																									
6: *10.4	↑																									
7: *10.4	↑																									
8: 8.2	↓																									
9: 9.5	↓																									
10: *10.8	↓																									
Serie 95.0																										
Total 0.0																										
<table style="width:100%; border-collapse: collapse;"> <tr><td colspan="2">Serie 48.0</td></tr> <tr><td colspan="2">Total 48.0</td></tr> </table>	Serie 48.0		Total 48.0		<table style="width:100%; border-collapse: collapse;"> <tr><td colspan="2">Serie 48.0</td></tr> <tr><td colspan="2">Total 48.0</td></tr> </table>	Serie 48.0		Total 48.0		<table style="width:100%; border-collapse: collapse;"> <tr><td colspan="2">Serie 48.0</td></tr> <tr><td colspan="2">Total 48.0</td></tr> </table>	Serie 48.0		Total 48.0													
Serie 48.0																										
Total 48.0																										
Serie 48.0																										
Total 48.0																										
Serie 48.0																										
Total 48.0																										

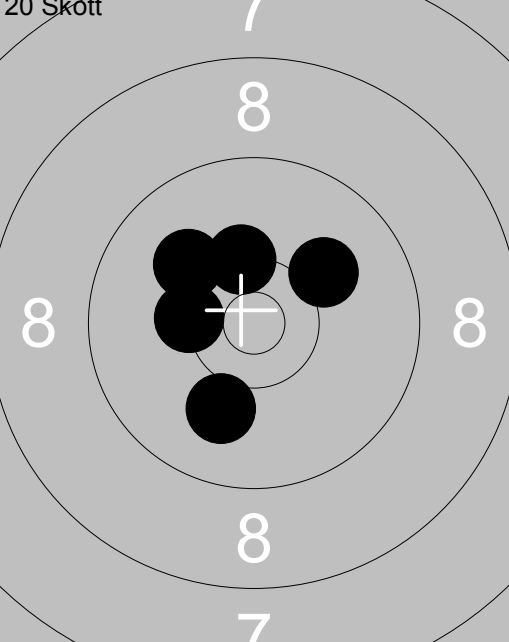
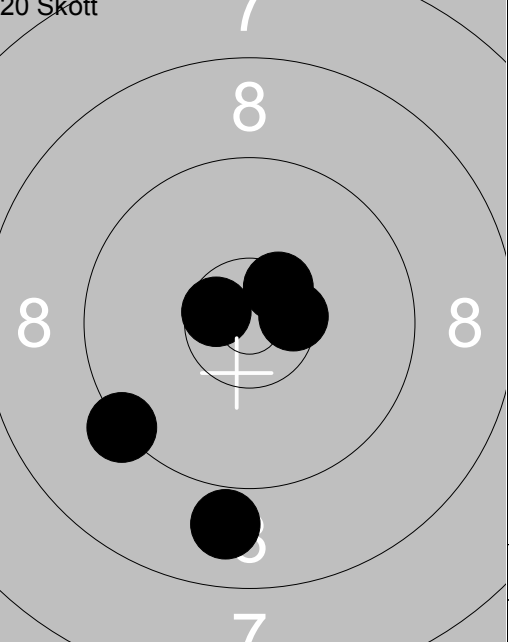
20 Skott 	20 Skott 	<table style="width:100%; border-collapse: collapse;"> <tr><td>6: 10.1</td><td style="text-align: right;">↖</td></tr> <tr><td>7: *10.3</td><td style="text-align: right;">↑</td></tr> <tr><td>8: 10.0</td><td style="text-align: right;">↓</td></tr> <tr><td>9: 10.1</td><td style="text-align: right;">↗</td></tr> <tr><td>10: *10.3</td><td style="text-align: right;">←</td></tr> <tr><td colspan="2">Serie 50.0</td></tr> <tr><td colspan="2">Total 98.0</td></tr> </table>	6: 10.1	↖	7: *10.3	↑	8: 10.0	↓	9: 10.1	↗	10: *10.3	←	Serie 50.0		Total 98.0	
6: 10.1	↖															
7: *10.3	↑															
8: 10.0	↓															
9: 10.1	↗															
10: *10.3	←															
Serie 50.0																
Total 98.0																
<table style="width:100%; border-collapse: collapse;"> <tr><td colspan="2">Serie 47.0</td></tr> <tr><td colspan="2">Total 145.0</td></tr> </table>	Serie 47.0		Total 145.0		<table style="width:100%; border-collapse: collapse;"> <tr><td colspan="2">Serie 47.0</td></tr> <tr><td colspan="2">Total 145.0</td></tr> </table>	Serie 47.0		Total 145.0		<table style="width:100%; border-collapse: collapse;"> <tr><td colspan="2">Serie 47.0</td></tr> <tr><td colspan="2">Total 145.0</td></tr> </table>	Serie 47.0		Total 145.0			
Serie 47.0																
Total 145.0																
Serie 47.0																
Total 145.0																
Serie 47.0																
Total 145.0																

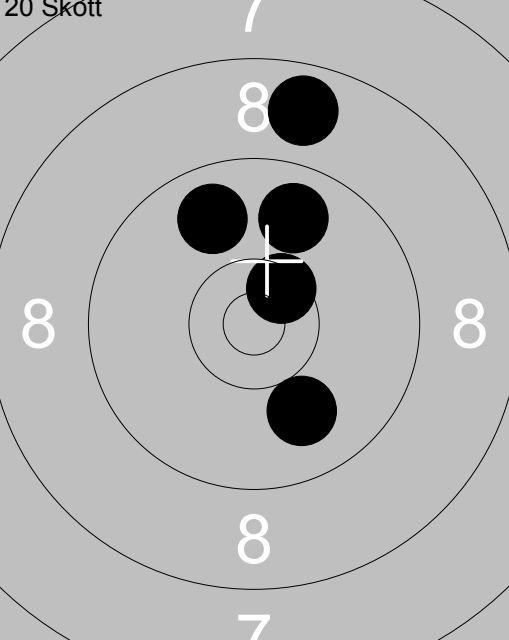
20 Skott 	<table style="width:100%; border-collapse: collapse;"> <tr><td>16: 9.8</td><td style="text-align: right;">↖</td></tr> <tr><td>17: *10.5</td><td style="text-align: right;">↗</td></tr> <tr><td>18: 8.8</td><td style="text-align: right;">↑</td></tr> <tr><td>19: 10.0</td><td style="text-align: right;">↓</td></tr> <tr><td>20: 9.8</td><td style="text-align: right;">↑</td></tr> <tr><td colspan="2">Serie 46.0</td></tr> <tr><td colspan="2">Total 191.0</td></tr> </table>	16: 9.8	↖	17: *10.5	↗	18: 8.8	↑	19: 10.0	↓	20: 9.8	↑	Serie 46.0		Total 191.0		<table style="width:100%; border-collapse: collapse;"> <tr><td colspan="2">Serie 46.0</td></tr> <tr><td colspan="2">Total 191.0</td></tr> </table>	Serie 46.0		Total 191.0	
16: 9.8	↖																			
17: *10.5	↗																			
18: 8.8	↑																			
19: 10.0	↓																			
20: 9.8	↑																			
Serie 46.0																				
Total 191.0																				
Serie 46.0																				
Total 191.0																				

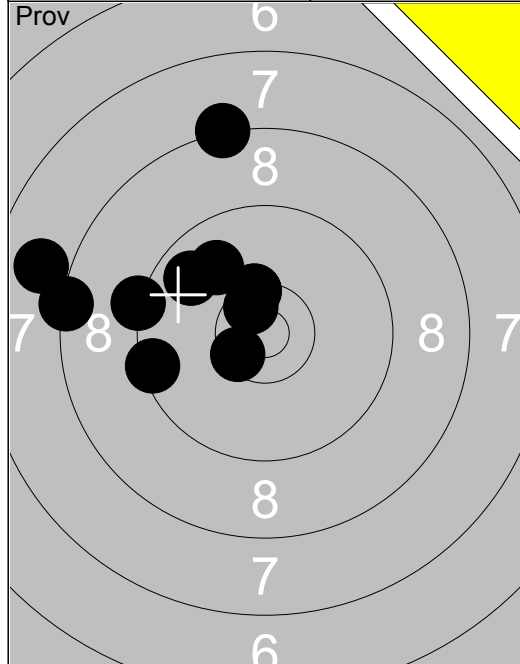

1:	8.3	↑
2:	*10.5	↙
3:	8.4	←
4:	7.9	←
5:	*10.4	↑
6:	9.4	←
7:	9.3	←
8:	9.8	↗
9:	*10.6	↗
10:	9.9	↗
Serie		89.0
Total		0.0

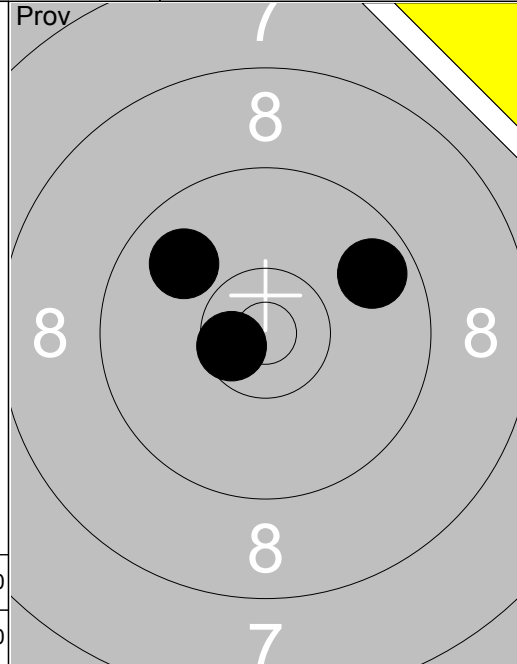

11:	9.7	↗
12:	9.9	↖
13:	*10.6	↙
Serie		28.0
Total		0.0

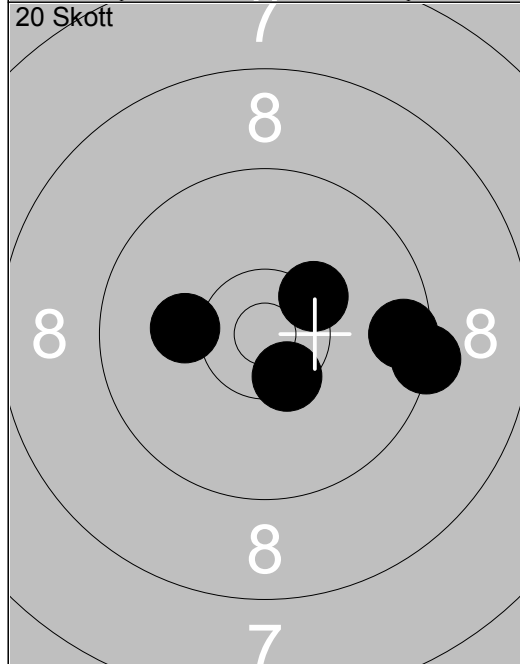

1:	*10.3	↗
2:	*10.5	↘
3:	9.6	→
4:	10.1	←
5:	9.3	→
Serie		48.0
Total		48.0

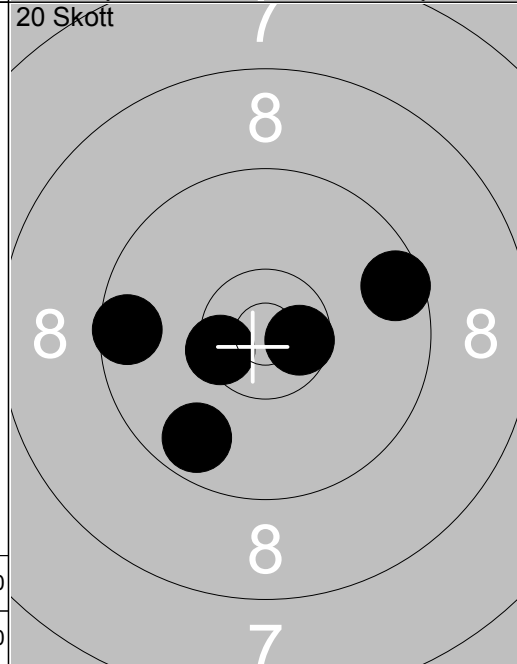

6:	9.6	↗
7:	*10.5	↙
8:	9.6	←
9:	*10.6	→
10:	9.7	↘
Serie		47.0
Total		95.0

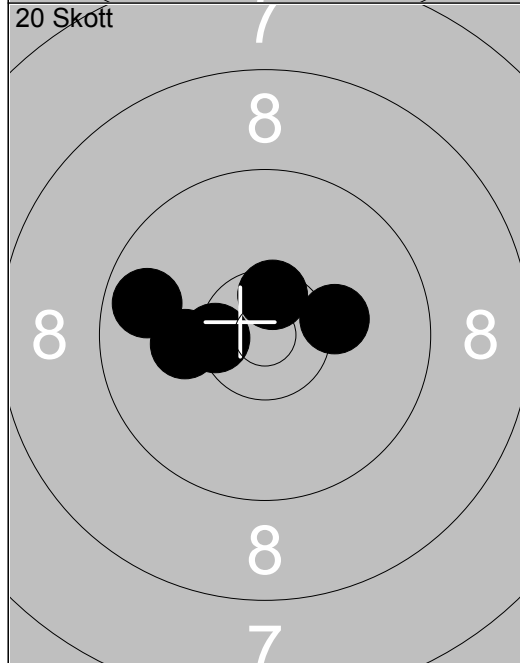

11:	10.2	→
12:	*10.5	↑
13:	10.1	←
14:	*10.5	←
15:	9.7	←
Serie		49.0
Total		144.0

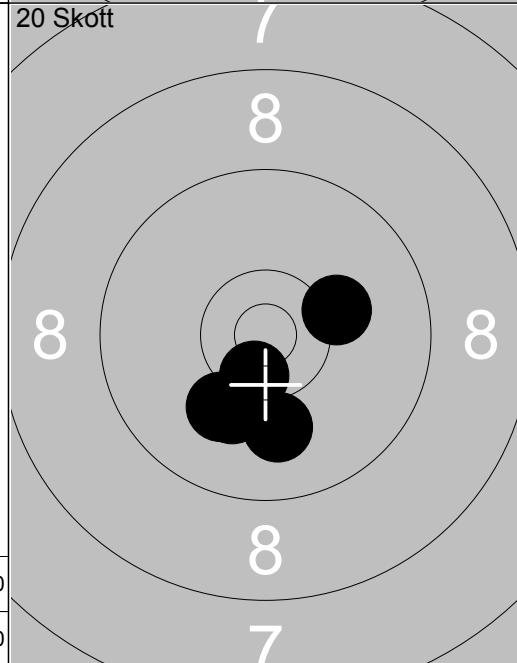

16:	10.1	↘
17:	*10.5	↘
18:	10.2	↗
19:	10.0	↘
20:	10.1	↘
Serie		50.0
Total		194.0

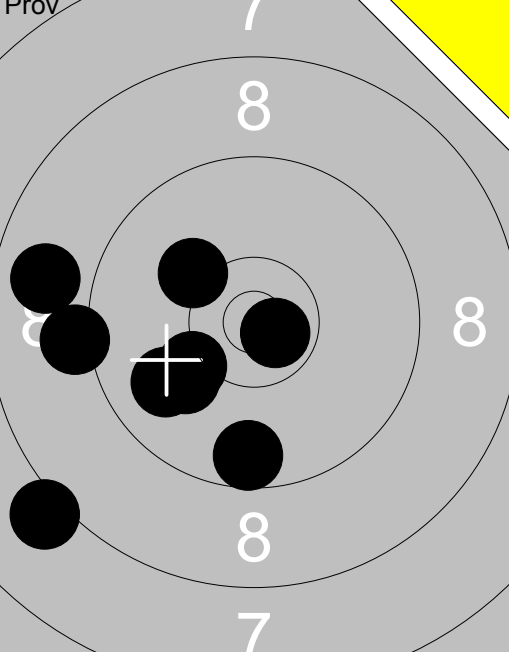
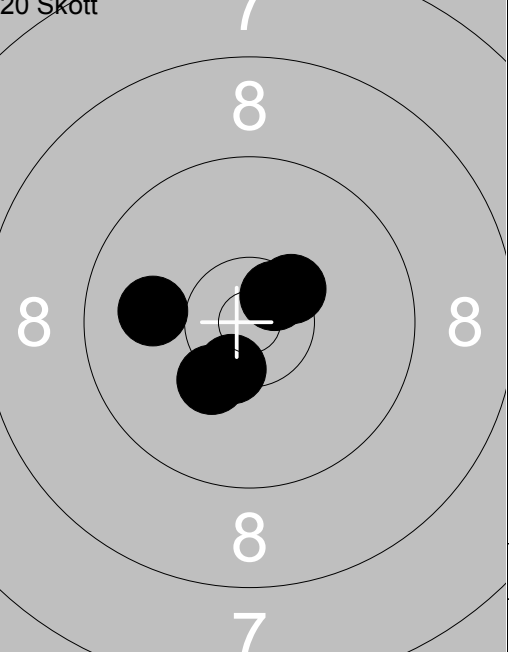

<p>Prov</p> 	<p>20 Skott</p> 	<table style="width:100%; border-collapse: collapse;"> <tr><td>1: 8.1 ↙</td><td>1: *10.6 ↗</td></tr> <tr><td>2: 9.2 ←</td><td>2: 10.3 ↙</td></tr> <tr><td>3: 10.2 ↗</td><td>3: *10.4 ↗</td></tr> <tr><td>4: 8.8 ←</td><td>4: 10.0 ←</td></tr> <tr><td>5: *10.7 →</td><td>5: *10.4 ↙</td></tr> <tr><td>6: 9.9 ↙</td><td></td></tr> <tr><td>7: 10.2 ↙</td><td></td></tr> <tr><td>8: 9.6 ↓</td><td></td></tr> <tr><td>9: 10.1 ↙</td><td></td></tr> </table> <table style="width:100%; border-collapse: collapse; margin-top: 5px;"> <tr><td style="border-top: 1px solid black;">Serie</td><td style="border-top: 1px solid black; text-align: right;">83.0</td></tr> <tr><td style="border-top: 1px solid black;">Total</td><td style="border-top: 1px solid black; text-align: right;">0.0</td></tr> </table>	1: 8.1 ↙	1: *10.6 ↗	2: 9.2 ←	2: 10.3 ↙	3: 10.2 ↗	3: *10.4 ↗	4: 8.8 ←	4: 10.0 ←	5: *10.7 →	5: *10.4 ↙	6: 9.9 ↙		7: 10.2 ↙		8: 9.6 ↓		9: 10.1 ↙		Serie	83.0	Total	0.0
1: 8.1 ↙	1: *10.6 ↗																							
2: 9.2 ←	2: 10.3 ↙																							
3: 10.2 ↗	3: *10.4 ↗																							
4: 8.8 ←	4: 10.0 ←																							
5: *10.7 →	5: *10.4 ↙																							
6: 9.9 ↙																								
7: 10.2 ↙																								
8: 9.6 ↓																								
9: 10.1 ↙																								
Serie	83.0																							
Total	0.0																							

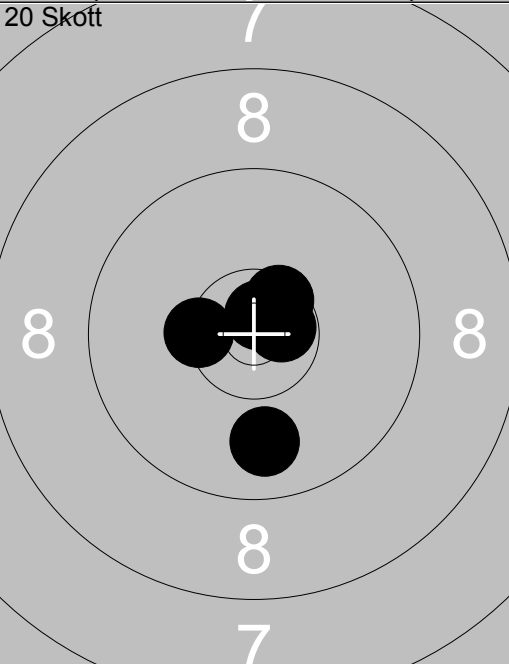
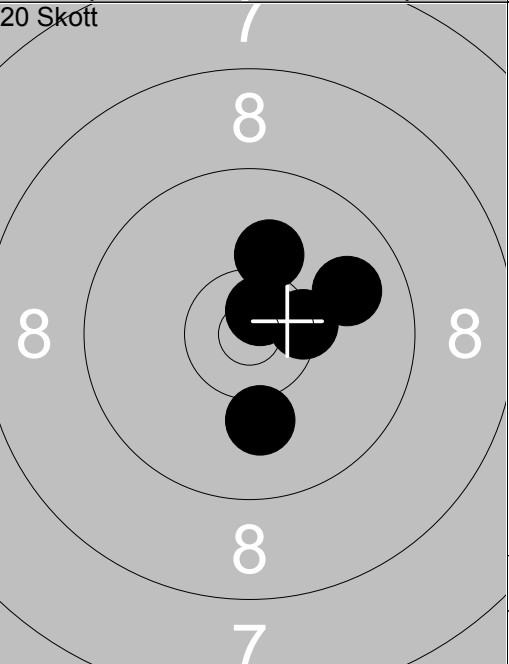
<p>20 Skott</p> 	<p>20 Skott</p> 	<table style="width:100%; border-collapse: collapse;"> <tr><td>6: *10.4 ←</td><td>11: 9.9 →</td></tr> <tr><td>7: *10.5 ↗</td><td>12: *10.4 →</td></tr> <tr><td>8: *10.7 →</td><td>13: 10.1 ↓</td></tr> <tr><td>9: *10.8 ↑</td><td>14: 10.1 ↑</td></tr> <tr><td>10: 9.9 ↓</td><td>15: *10.7 ↑</td></tr> </table> <table style="width:100%; border-collapse: collapse; margin-top: 5px;"> <tr><td style="border-top: 1px solid black;">Serie</td><td style="border-top: 1px solid black; text-align: right;">49.0</td></tr> <tr><td style="border-top: 1px solid black;">Total</td><td style="border-top: 1px solid black; text-align: right;">99.0</td></tr> </table>	6: *10.4 ←	11: 9.9 →	7: *10.5 ↗	12: *10.4 →	8: *10.7 →	13: 10.1 ↓	9: *10.8 ↑	14: 10.1 ↑	10: 9.9 ↓	15: *10.7 ↑	Serie	49.0	Total	99.0
6: *10.4 ←	11: 9.9 →															
7: *10.5 ↗	12: *10.4 →															
8: *10.7 →	13: 10.1 ↓															
9: *10.8 ↑	14: 10.1 ↑															
10: 9.9 ↓	15: *10.7 ↑															
Serie	49.0															
Total	99.0															

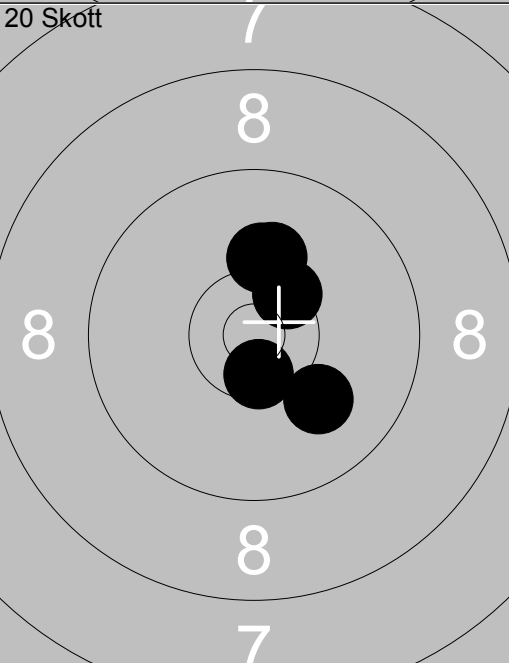
<p>20 Skott</p> 		<table style="width:100%; border-collapse: collapse;"> <tr><td>16: 10.1 ↑</td></tr> <tr><td>17: *10.6 ↓</td></tr> <tr><td>18: 10.2 ↑</td></tr> <tr><td>19: 10.0 ↘</td></tr> <tr><td>20: *10.4 ↗</td></tr> </table> <table style="width:100%; border-collapse: collapse; margin-top: 5px;"> <tr><td style="border-top: 1px solid black;">Serie</td><td style="border-top: 1px solid black; text-align: right;">50.0</td></tr> <tr><td style="border-top: 1px solid black;">Total</td><td style="border-top: 1px solid black; text-align: right;">198.0</td></tr> </table>	16: 10.1 ↑	17: *10.6 ↓	18: 10.2 ↑	19: 10.0 ↘	20: *10.4 ↗	Serie	50.0	Total	198.0
16: 10.1 ↑											
17: *10.6 ↓											
18: 10.2 ↑											
19: 10.0 ↘											
20: *10.4 ↗											
Serie	50.0										
Total	198.0										

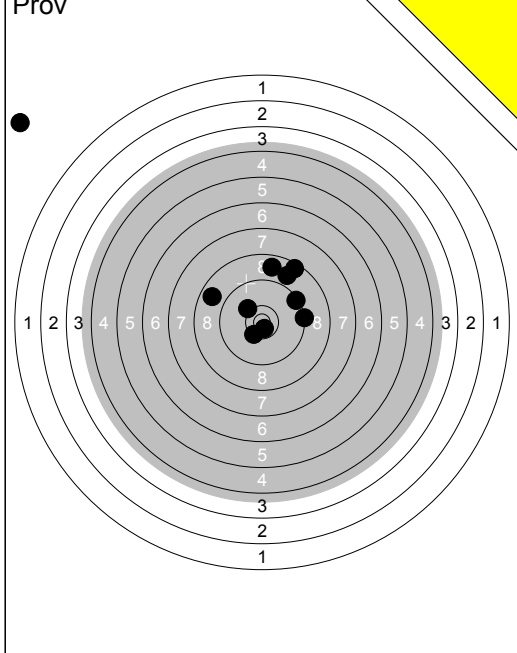

11:	10.1	↘
12:	*10.3	↘
13:	*10.3	→
Serie	30.0	
Total	0.0	

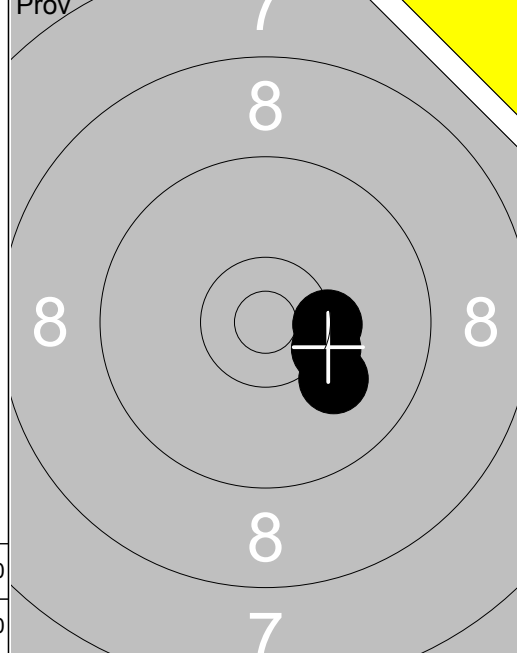

Serie	80.0	
Total	0.0	

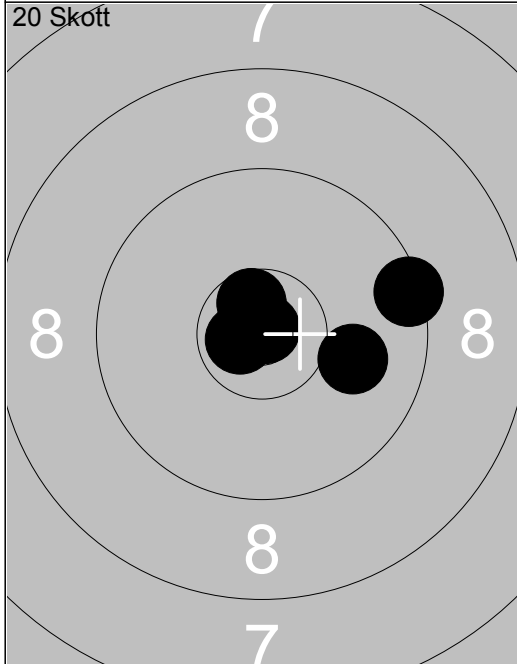

6:	9.2	↑
7:	*10.8	↖
8:	9.6	↗
9:	9.4	↖
10:	9.7	↗
Serie	46.0	
Total	95.0	

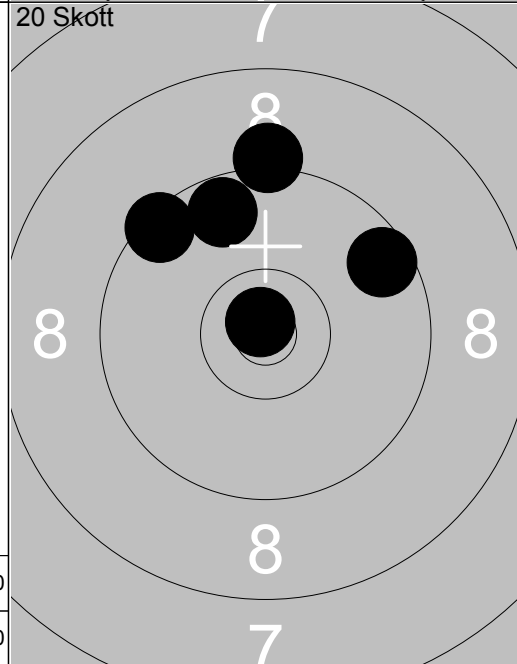

Serie	49.0	
Total	49.0	

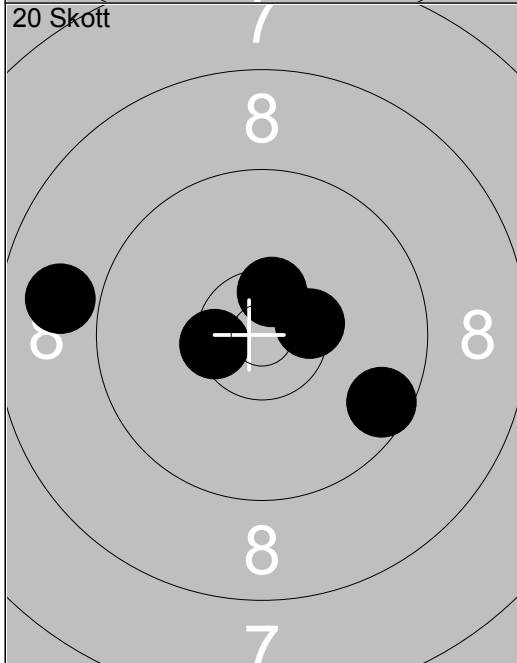

16:	*10.6	↘
17:	9.8	←
18:	9.0	←
19:	9.8	↘
20:	*10.7	↘
Serie	47.0	
Total	189.0	

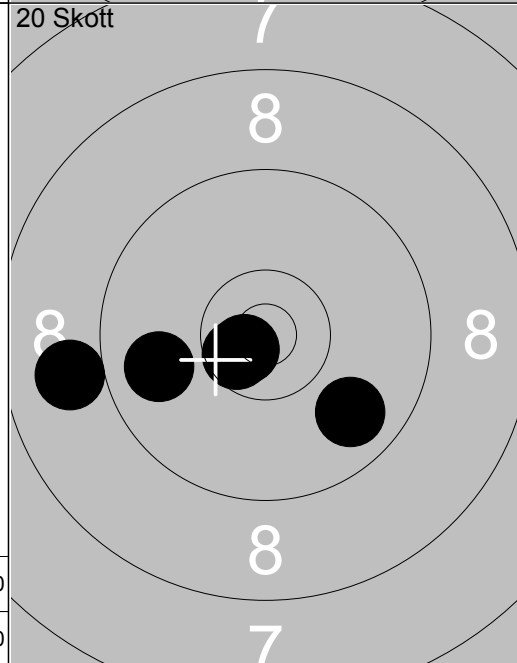

Serie	47.0	
Total	142.0	

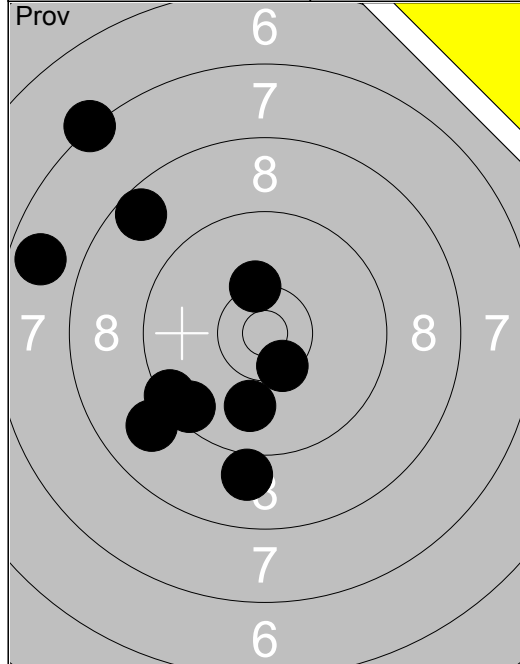

1:	7.3	↗
2:	7.7	←
3:	*10.3	↗
4:	10.0	↓
5:	9.0	↓
6:	*10.4	↓
7:	9.0	↙
8:	9.4	←
9:	9.5	↙
10:	8.6	↖
Serie		88.0
Total		0.0

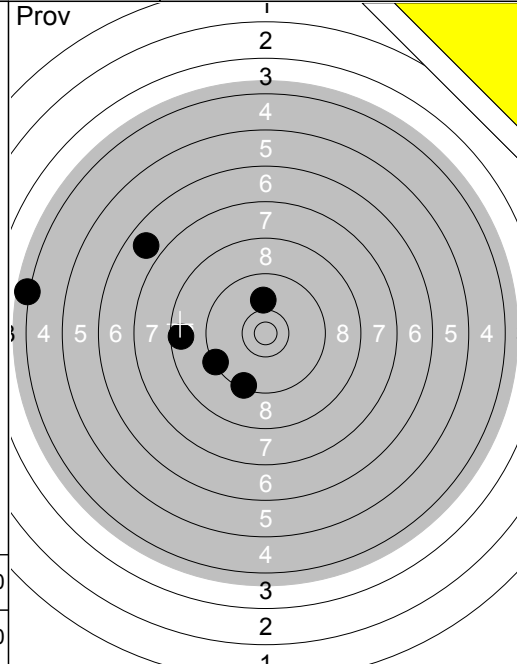

11:	9.4	↖
12:	10.0	↑
13:	4.2	←
14:	6.8	↖
15:	9.4	↓
16:	8.6	←
Serie		46.0
Total		0.0

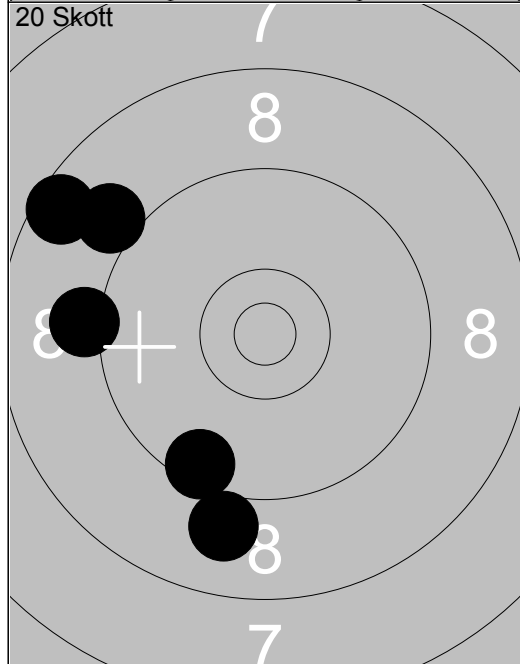

1:	9.0	↓
2:	8.6	↖
3:	9.5	↓
4:	9.0	↗
5:	9.1	←
Serie		44.0
Total		44.0

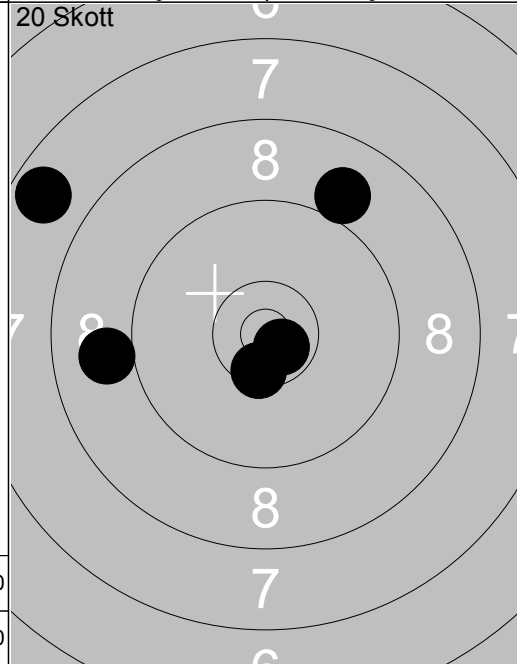

6:	9.0	←
7:	7.7	↖
8:	*10.7	↘
9:	*10.5	↓
10:	9.0	↗
Serie		45.0
Total		89.0

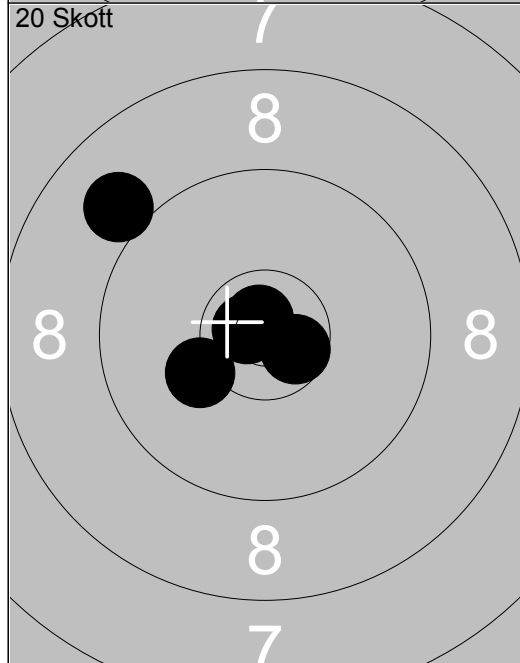

11:	*10.8	←
12:	*10.6	→
13:	9.0	↗
14:	10.2	←
15:	*10.8	↗
Serie		49.0
Total		138.0

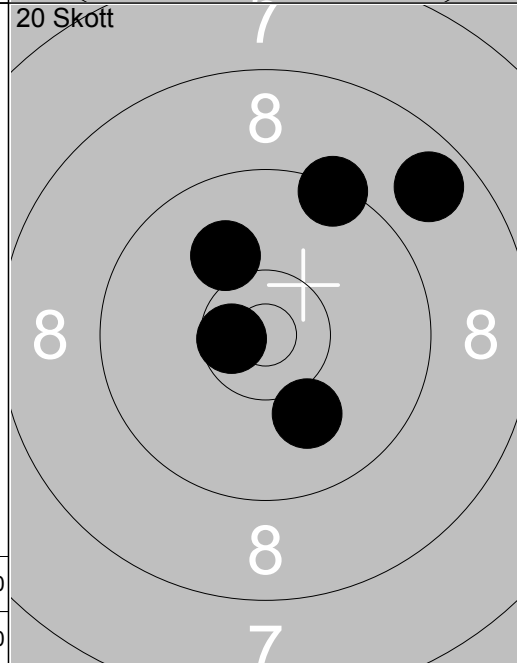

16:	10.1	↖
17:	8.8	↗
18:	*10.6	←
19:	9.4	↗
20:	10.1	↓
Serie		47.0
Total		185.0

Prov 	20 Skott 	<table style="width:100%; border-collapse: collapse;"> <tr><td>1: 9.3</td><td style="text-align: right;">↓</td></tr> <tr><td>2: 10.3</td><td style="text-align: right;">↓</td></tr> <tr><td>3: *10.6</td><td style="text-align: right;">↖</td></tr> <tr><td>4: 9.7</td><td style="text-align: right;">↓</td></tr> <tr><td>5: *10.4</td><td style="text-align: right;">↗</td></tr> <tr><td>6: 9.3</td><td style="text-align: right;">↗</td></tr> <tr><td>7: 9.8</td><td style="text-align: right;">↓</td></tr> </table> <table style="width:100%; border-collapse: collapse; margin-top: 5px;"> <tr><td style="border-top: 1px solid black;">Serie</td><td style="border-top: 1px solid black; text-align: right;">66.0</td></tr> <tr><td style="border-top: 1px solid black;">Total</td><td style="border-top: 1px solid black; text-align: right;">0.0</td></tr> </table>	1: 9.3	↓	2: 10.3	↓	3: *10.6	↖	4: 9.7	↓	5: *10.4	↗	6: 9.3	↗	7: 9.8	↓	Serie	66.0	Total	0.0	<table style="width:100%; border-collapse: collapse;"> <tr><td>1: 9.3</td><td style="text-align: right;">↖</td></tr> <tr><td>2: *10.7</td><td style="text-align: right;">↑</td></tr> <tr><td>3: *10.3</td><td style="text-align: right;">↗</td></tr> <tr><td>4: 9.2</td><td style="text-align: right;">↖</td></tr> <tr><td>5: 9.6</td><td style="text-align: right;">↓</td></tr> </table> <table style="width:100%; border-collapse: collapse; margin-top: 5px;"> <tr><td style="border-top: 1px solid black;">Serie</td><td style="border-top: 1px solid black; text-align: right;">47.0</td></tr> <tr><td style="border-top: 1px solid black;">Total</td><td style="border-top: 1px solid black; text-align: right;">47.0</td></tr> </table>	1: 9.3	↖	2: *10.7	↑	3: *10.3	↗	4: 9.2	↖	5: 9.6	↓	Serie	47.0	Total	47.0
1: 9.3	↓																																		
2: 10.3	↓																																		
3: *10.6	↖																																		
4: 9.7	↓																																		
5: *10.4	↗																																		
6: 9.3	↗																																		
7: 9.8	↓																																		
Serie	66.0																																		
Total	0.0																																		
1: 9.3	↖																																		
2: *10.7	↑																																		
3: *10.3	↗																																		
4: 9.2	↖																																		
5: 9.6	↓																																		
Serie	47.0																																		
Total	47.0																																		

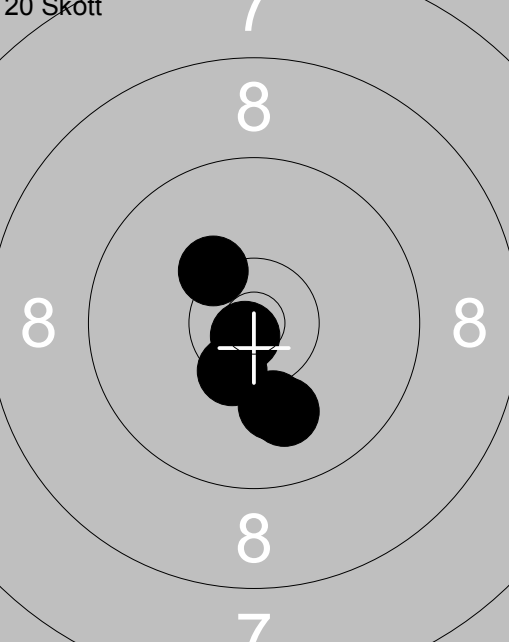
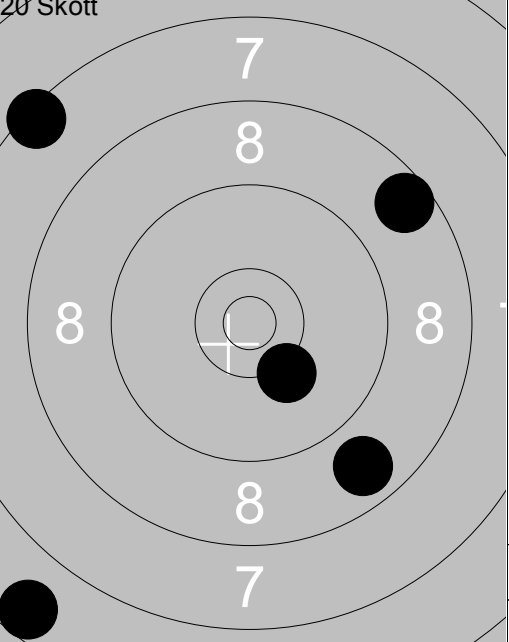
20 Skott 	20 Skott 	<table style="width:100%; border-collapse: collapse;"> <tr><td>6: *10.8</td><td style="text-align: right;">↘</td></tr> <tr><td>7: *10.3</td><td style="text-align: right;">↖</td></tr> <tr><td>8: *10.4</td><td style="text-align: right;">↓</td></tr> <tr><td>9: 10.1</td><td style="text-align: right;">↓</td></tr> <tr><td>10: 10.0</td><td style="text-align: right;">↓</td></tr> </table> <table style="width:100%; border-collapse: collapse; margin-top: 5px;"> <tr><td style="border-top: 1px solid black;">Serie</td><td style="border-top: 1px solid black; text-align: right;">50.0</td></tr> <tr><td style="border-top: 1px solid black;">Total</td><td style="border-top: 1px solid black; text-align: right;">97.0</td></tr> </table>	6: *10.8	↘	7: *10.3	↖	8: *10.4	↓	9: 10.1	↓	10: 10.0	↓	Serie	50.0	Total	97.0	<table style="width:100%; border-collapse: collapse;"> <tr><td>11: 8.6</td><td style="text-align: right;">↗</td></tr> <tr><td>12: 7.4</td><td style="text-align: right;">↖</td></tr> <tr><td>13: 8.8</td><td style="text-align: right;">↓</td></tr> <tr><td>14: 10.2</td><td style="text-align: right;">↓</td></tr> <tr><td>15: 6.6</td><td style="text-align: right;">↘</td></tr> </table> <table style="width:100%; border-collapse: collapse; margin-top: 5px;"> <tr><td style="border-top: 1px solid black;">Serie</td><td style="border-top: 1px solid black; text-align: right;">39.0</td></tr> <tr><td style="border-top: 1px solid black;">Total</td><td style="border-top: 1px solid black; text-align: right;">136.0</td></tr> </table>	11: 8.6	↗	12: 7.4	↖	13: 8.8	↓	14: 10.2	↓	15: 6.6	↘	Serie	39.0	Total	136.0
6: *10.8	↘																														
7: *10.3	↖																														
8: *10.4	↓																														
9: 10.1	↓																														
10: 10.0	↓																														
Serie	50.0																														
Total	97.0																														
11: 8.6	↗																														
12: 7.4	↖																														
13: 8.8	↓																														
14: 10.2	↓																														
15: 6.6	↘																														
Serie	39.0																														
Total	136.0																														

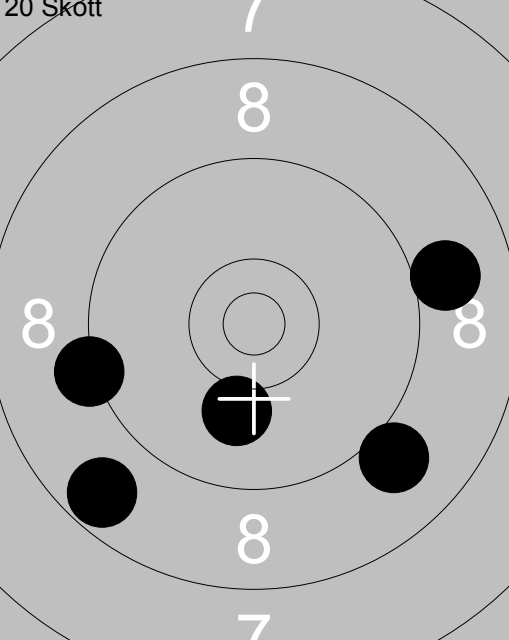
20 Skott 		<table style="width:100%; border-collapse: collapse;"> <tr><td>16: 9.0</td><td style="text-align: right;">↘</td></tr> <tr><td>17: 9.0</td><td style="text-align: right;">→</td></tr> <tr><td>18: 10.1</td><td style="text-align: right;">↓</td></tr> <tr><td>19: 9.2</td><td style="text-align: right;">←</td></tr> <tr><td>20: 8.7</td><td style="text-align: right;">↘</td></tr> </table> <table style="width:100%; border-collapse: collapse; margin-top: 5px;"> <tr><td style="border-top: 1px solid black;">Serie</td><td style="border-top: 1px solid black; text-align: right;">45.0</td></tr> <tr><td style="border-top: 1px solid black;">Total</td><td style="border-top: 1px solid black; text-align: right;">181.0</td></tr> </table>	16: 9.0	↘	17: 9.0	→	18: 10.1	↓	19: 9.2	←	20: 8.7	↘	Serie	45.0	Total	181.0
16: 9.0	↘															
17: 9.0	→															
18: 10.1	↓															
19: 9.2	←															
20: 8.7	↘															
Serie	45.0															
Total	181.0															

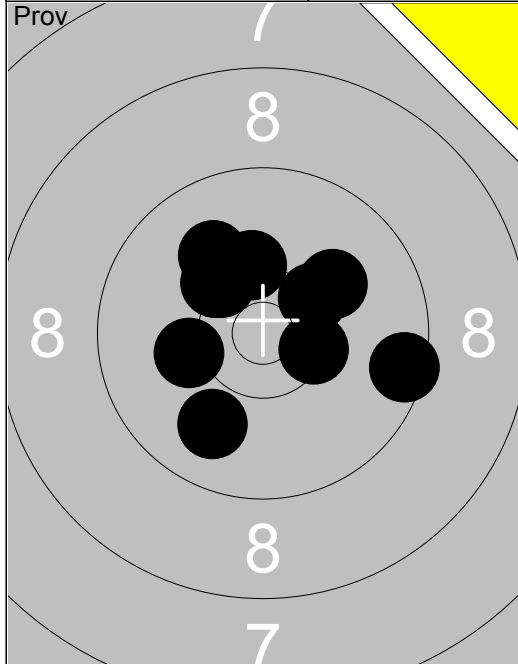

1:	9.9	↙
2:	10.3	↑
3:	*10.3	↗
4:	9.5	→
5:	10.0	↗
6:	10.2	←
7:	*10.3	↗
8:	10.3	↗
9:	10.1	↗
10:	*10.4	→
Serie		98.0
Total		0.0

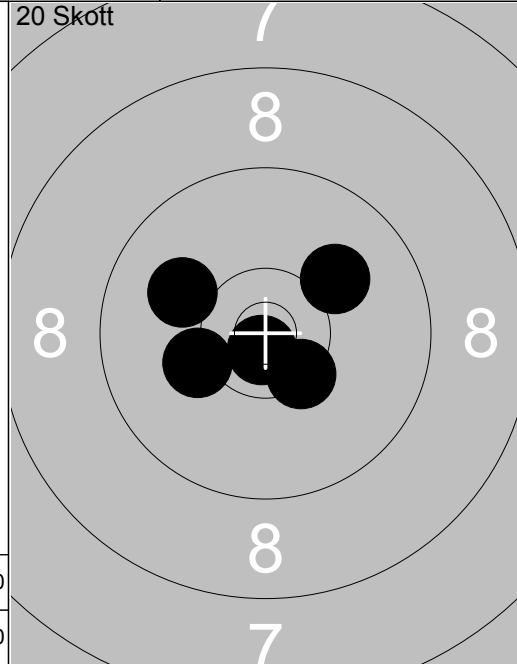

1:	10.0	↖
2:	10.1	↗
3:	*10.8	↓
4:	10.2	↖
5:	*10.4	↘
Serie		50.0
Total		50.0

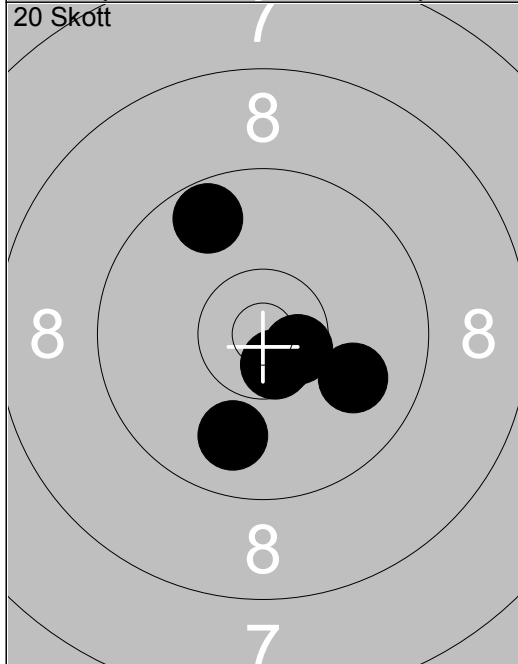

6:	9.7	↗
7:	*10.6	↓
8:	*10.6	→
9:	10.0	→
10:	9.9	↓
Serie		48.0
Total		98.0

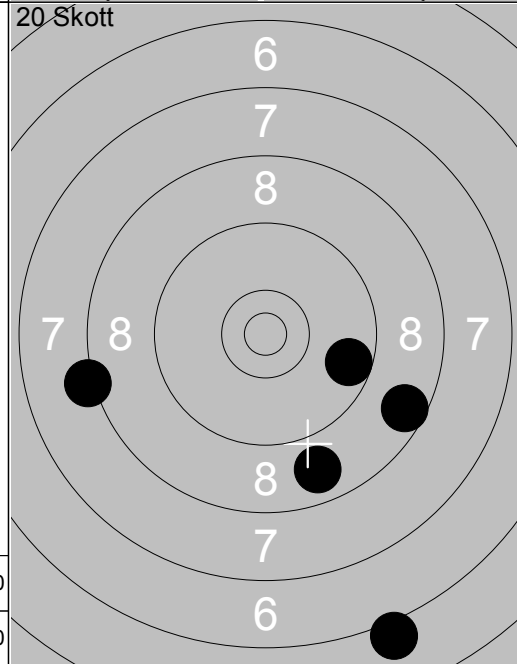

11:	9.6	→
12:	6.1	↓
13:	8.8	↓
14:	8.6	→
15:	8.2	←
Serie		39.0
Total		137.0

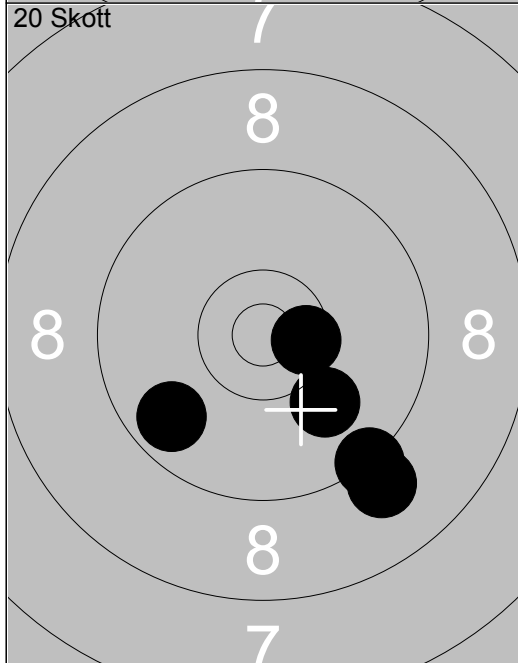

16:	9.3	↘
17:	9.1	↘
18:	10.0	↘
19:	9.7	↘
20:	*10.5	→
Serie		47.0
Total		184.0

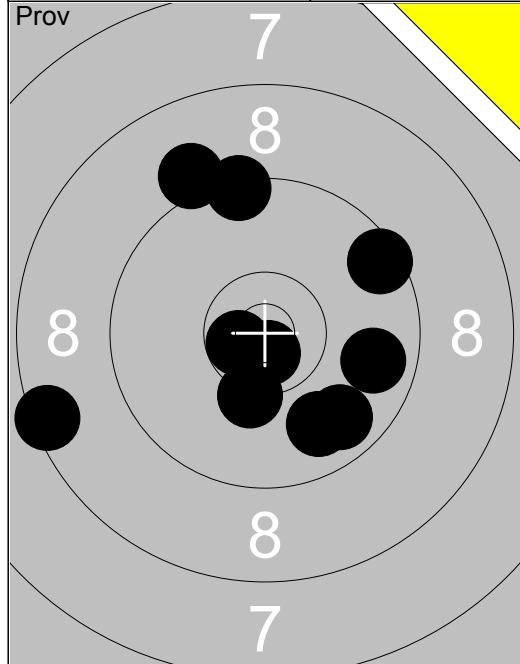

1:	8.5	←
2:	*10.6	←
3:	9.8	↓
4:	9.5	↗
5:	*10.7	↓
6:	9.1	↑
7:	9.4	↑
8:	10.3	↓
9:	9.8	→
10:	9.8	↓
Serie		92.0
Total		0.0

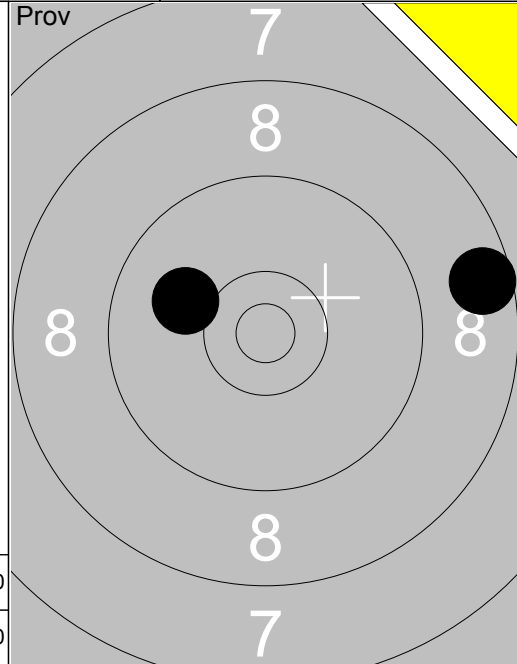

11:	8.6	→
12:	10.0	←
Serie		18.0
Total		0.0

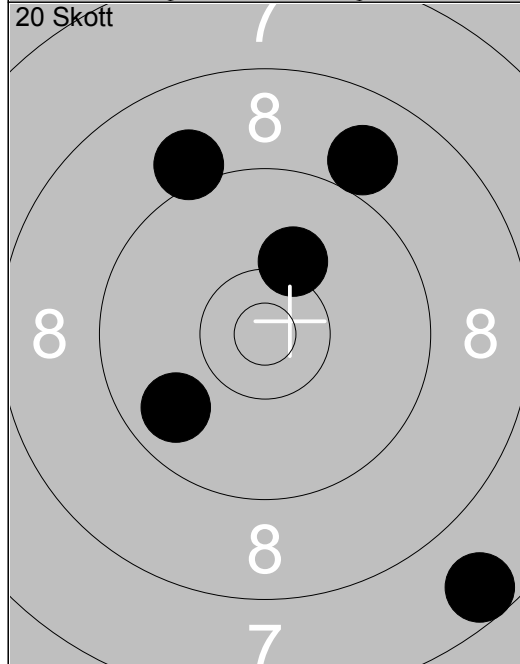

1:	9.1	↑
2:	9.8	←
3:	10.2	↑
4:	7.6	↓
5:	9.0	↗
Serie		44.0
Total		44.0

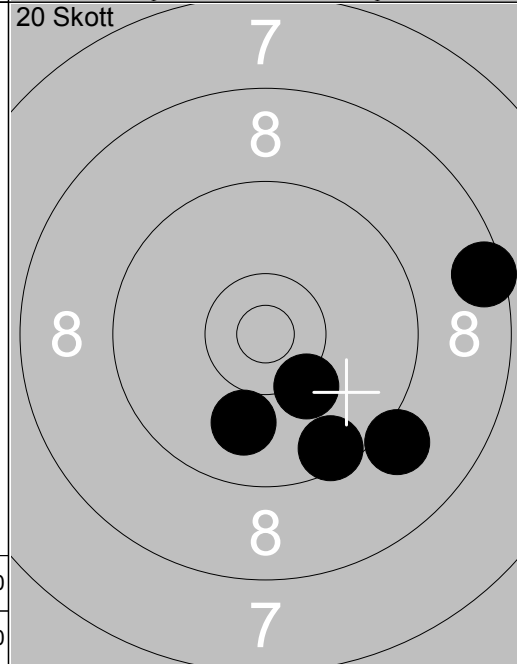

6:	9.1	↓
7:	9.5	↓
8:	10.0	↓
9:	8.5	→
10:	10.2	↓
Serie		46.0
Total		90.0

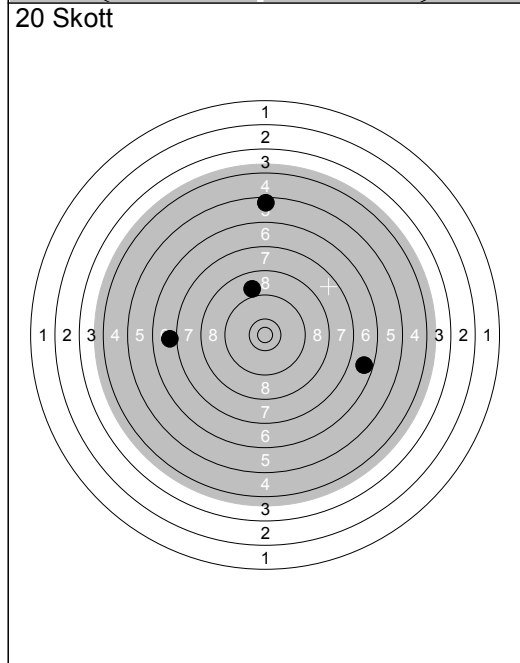

11:	5.5	↑
12:	9.0	↑
13:	0.0	→
14:	6.7	→
15:	7.0	←
Serie		27.0
Total		117.0

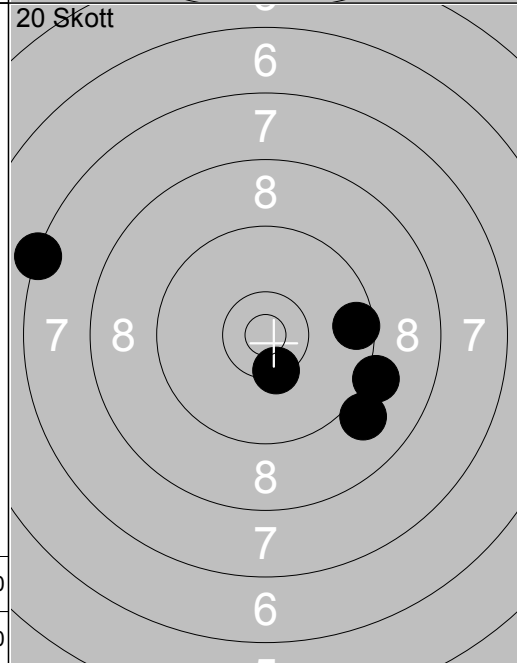

16:	9.6	→
17:	7.3	←
18:	*10.4	↓
19:	9.0	↓
20:	9.2	→
Serie		44.0
Total		161.0

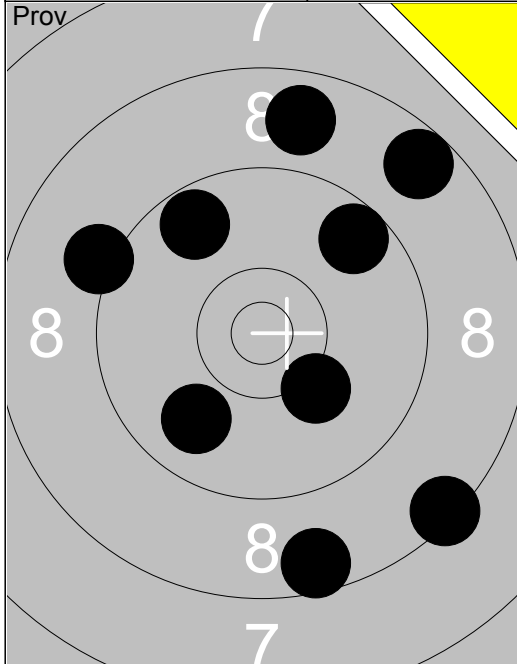

1:	9.9	↙
2:	8.4	↘
3:	9.7	↗
4:	9.6	↗
5:	8.8	↑
6:	10.2	↘
7:	8.6	↗
8:	8.6	↘
9:	9.2	↖

Serie	78.0
Total	0.0

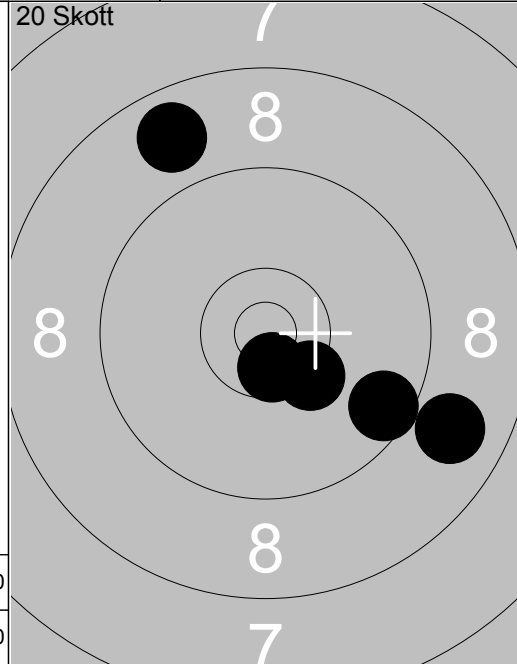

1:	*10.6	↘
2:	*10.3	↘
3:	8.9	↘
4:	9.6	↘
5:	8.8	↗

Serie	45.0
Total	45.0

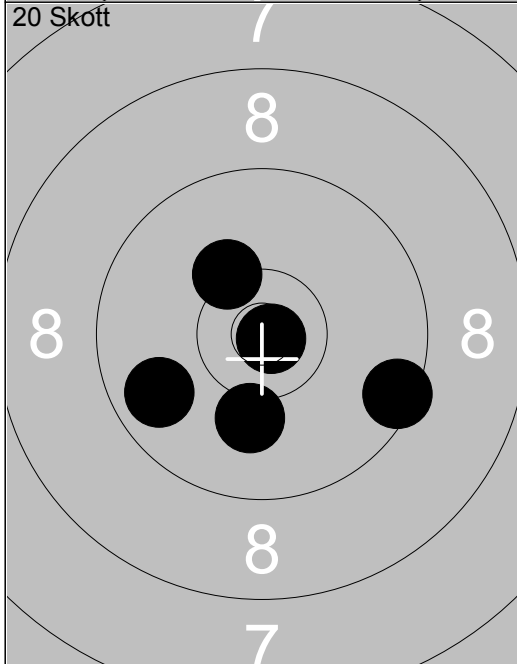

6:	*10.9	↘
7:	9.8	↖
8:	10.3	↗
9:	10.1	↘
10:	9.5	↘

Serie	48.0
Total	93.0

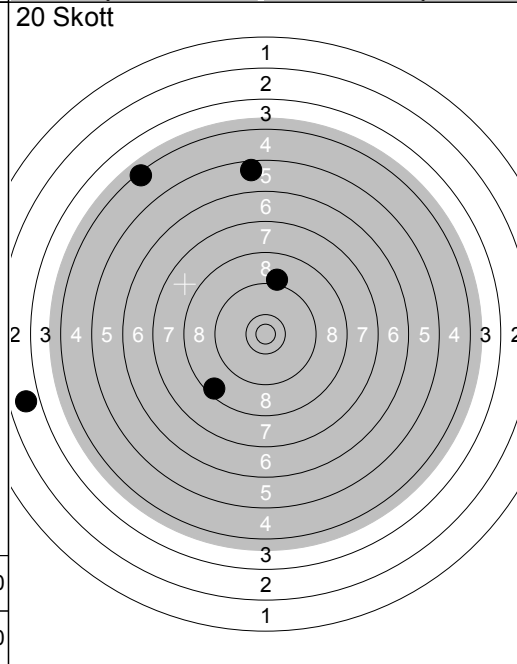

11:	8.5	↖
12:	5.6	↑
13:	4.4	↖
14:	2.9	↖
15:	9.1	↑

Serie	28.0
Total	121.0

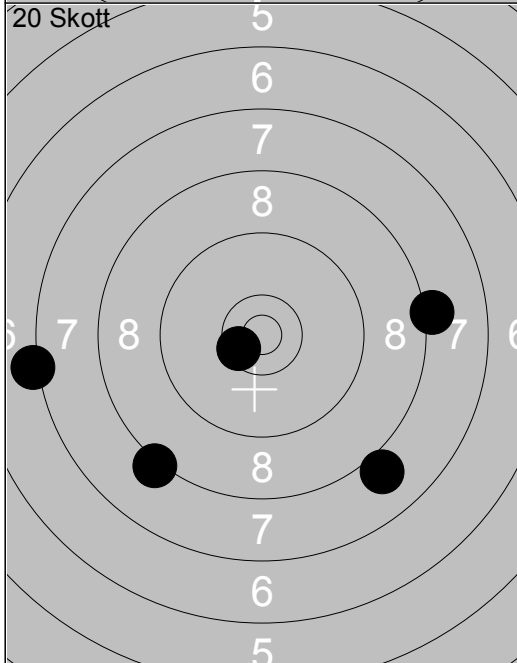

16:	*10.5	↖
17:	7.2	←
18:	8.2	→
19:	8.0	↘
20:	8.2	↖

Serie	41.0
Total	162.0

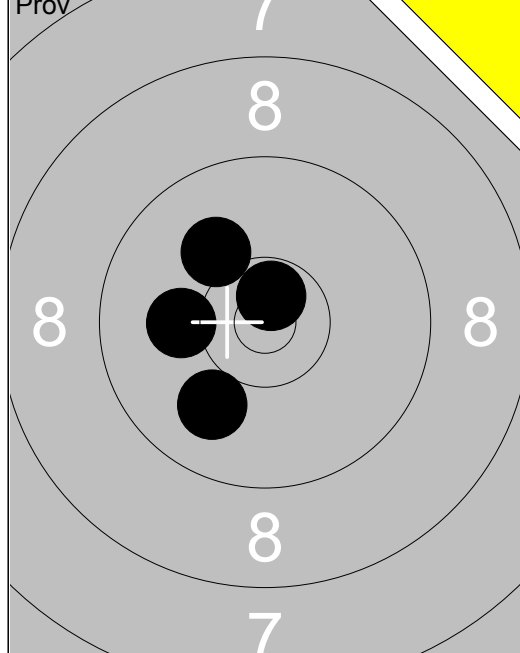

1:	*10.7	↗
2:	10.1	←
3:	10.1	↖
4:	10.0	↘
Serie		40.0
Total		0.0

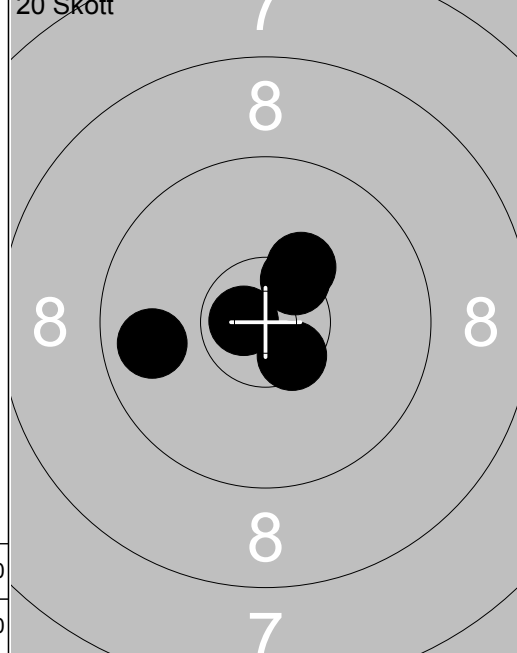

1:	*10.4	↗
2:	9.8	←
3:	*10.5	↘
4:	*10.7	←
5:	*10.3	↗
Serie		49.0
Total		49.0

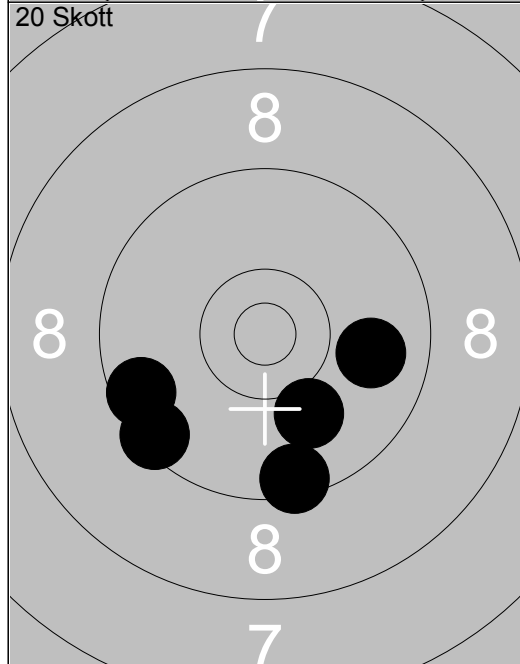

6:	9.5	↘
7:	10.0	↘
8:	9.9	→
9:	9.5	↘
10:	9.6	←
Serie		46.0
Total		95.0

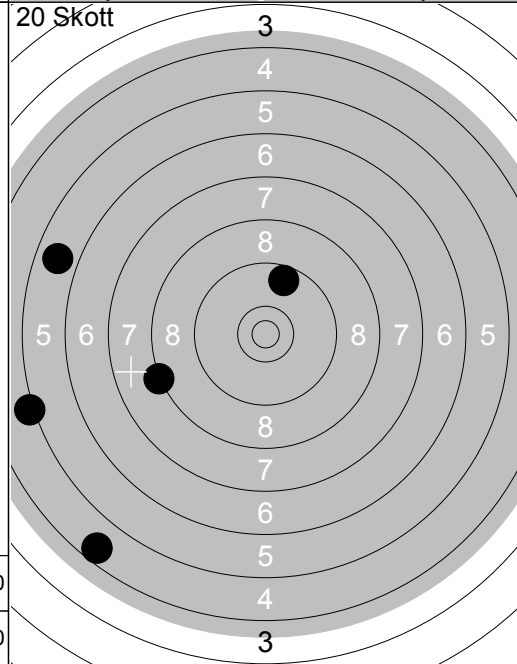

11:	4.6	↘
12:	9.6	↗
13:	8.3	←
14:	5.2	←
15:	5.8	←
Serie		31.0
Total		126.0

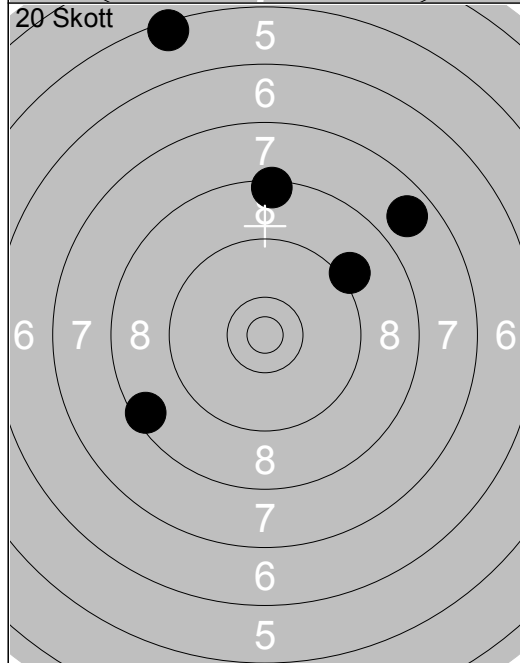

16:	8.5	↖
17:	7.8	↗
18:	9.1	↗
19:	8.4	↑
20:	5.5	↖
Serie		37.0
Total		163.0



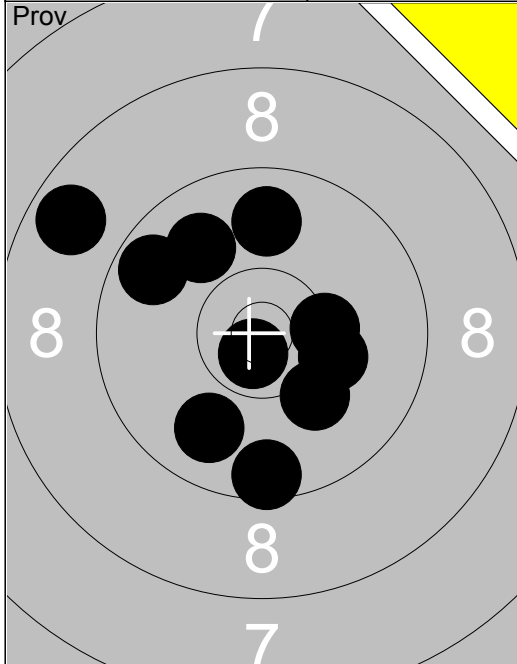

1:	9.9	↗
2:	8.7	↗
3:	10.2	→
4:	9.5	↓
5:	10.1	↓
6:	*10.7	↓
7:	9.8	↑
8:	9.9	↙
9:	9.7	↖
10:	*10.3	→
Serie		93.0
Total		0.0

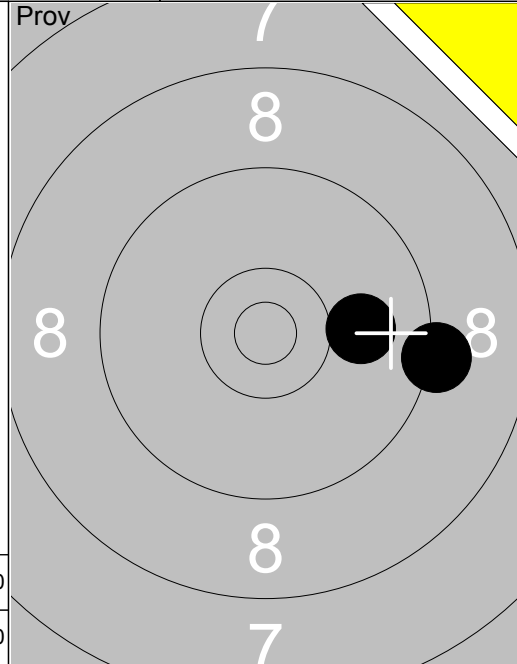

11:	9.2	→
12:	10.0	→
Serie		19.0
Total		0.0

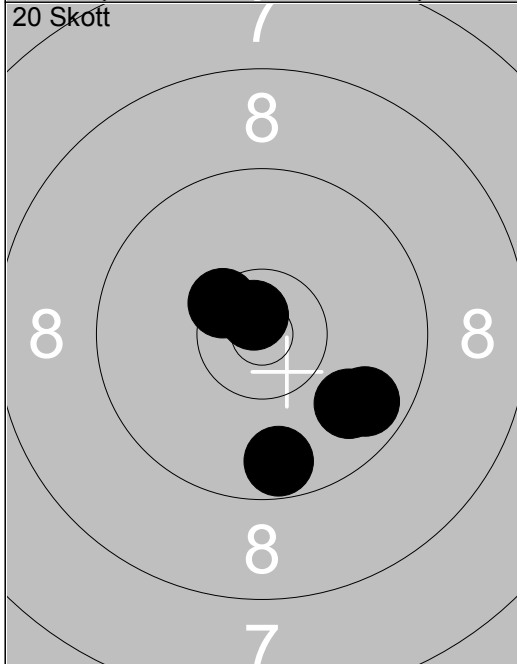

1:	9.8	↘
2:	9.7	↘
3:	9.7	↓
4:	*10.5	↗
5:	*10.7	↗
Serie		47.0
Total		47.0

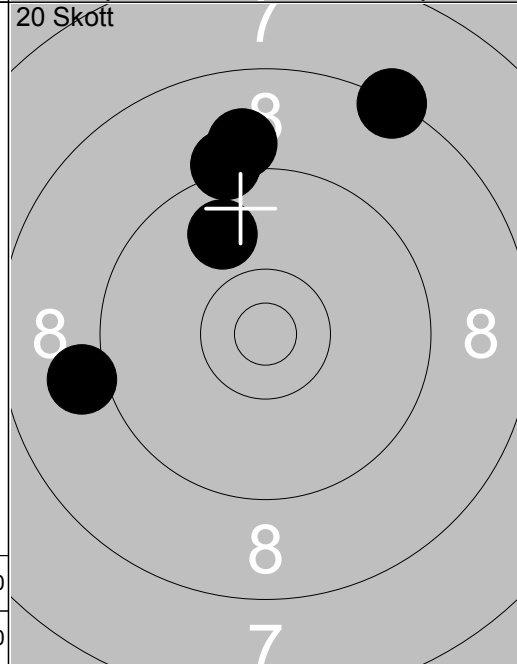

6:	9.0	↑
7:	9.1	←
8:	8.3	↗
9:	9.9	↑
10:	9.2	↑
Serie		44.0
Total		91.0

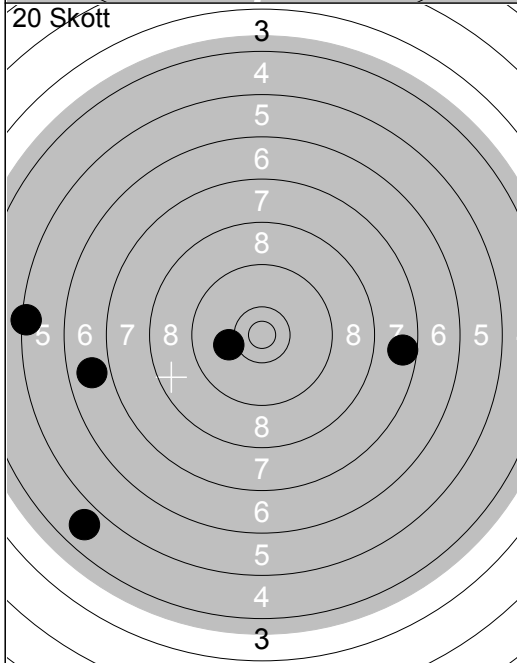

11:	7.6	→
12:	5.4	←
13:	4.8	↘
14:	6.9	←
15:	10.1	←
Serie		32.0
Total		123.0

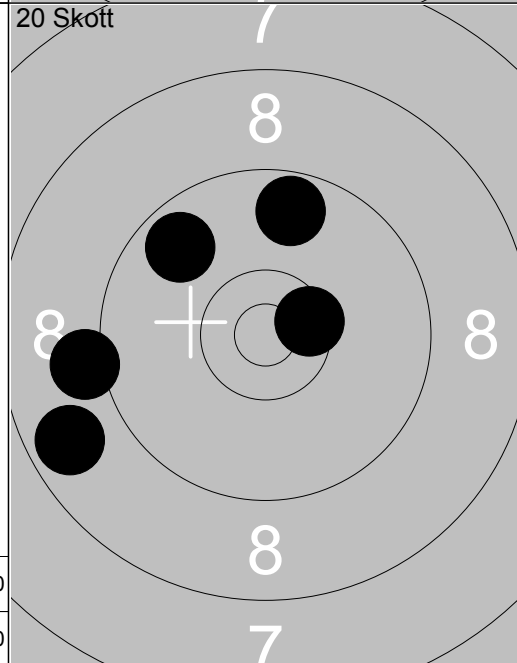

16:	9.1	←
17:	*10.5	→
18:	9.7	↑
19:	9.7	↖
20:	8.7	↙
Serie		45.0
Total		168.0

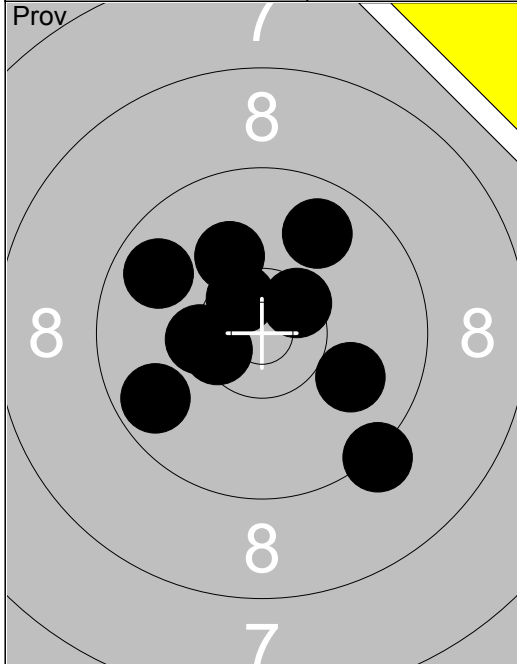

1:	9.8	↗
2:	*10.5	↗
3:	9.8	↖
4:	*10.3	←
5:	9.7	↖
6:	10.1	↗
7:	9.3	↘
8:	*10.5	↗
9:	*10.5	←
10:	10.0	↘
Serie		96.0
Total		0.0

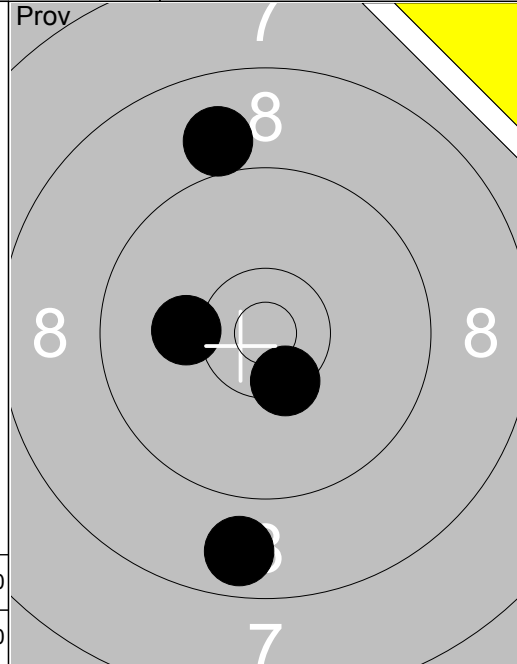

11:	9.0	↗
12:	10.2	←
13:	8.8	↘
14:	*10.4	↘
Serie		37.0
Total		0.0

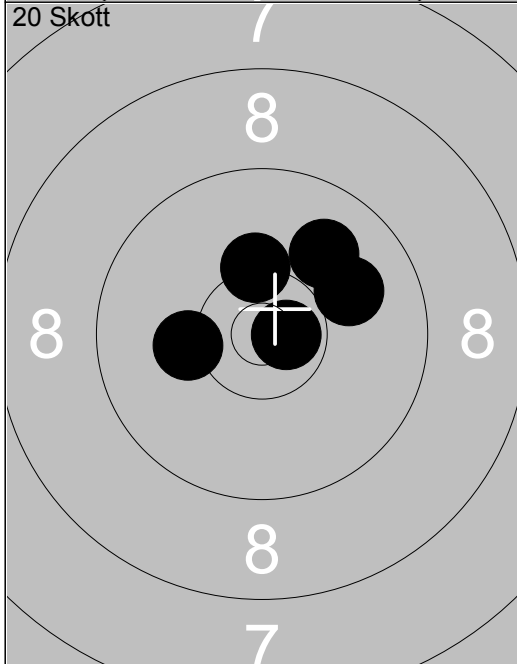

1:	10.2	←
2:	*10.7	→
3:	10.0	↗
4:	10.3	↑
5:	9.9	↗
Serie		49.0
Total		49.0

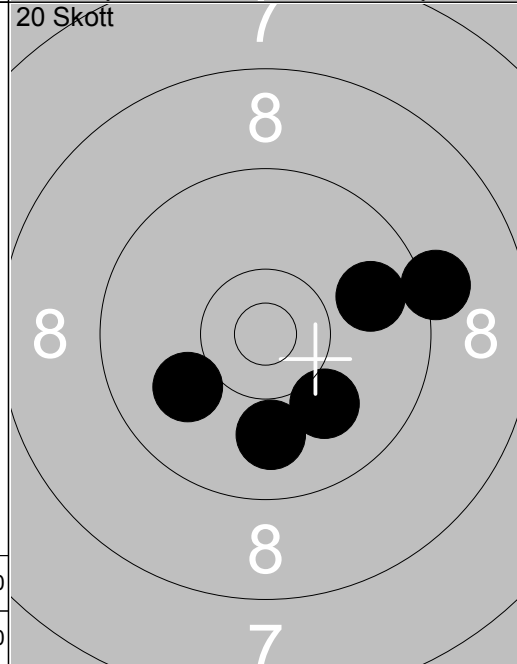

6:	10.0	↘
7:	9.8	↗
8:	9.9	↘
9:	9.2	↗
10:	10.0	↖
Serie		47.0
Total		96.0

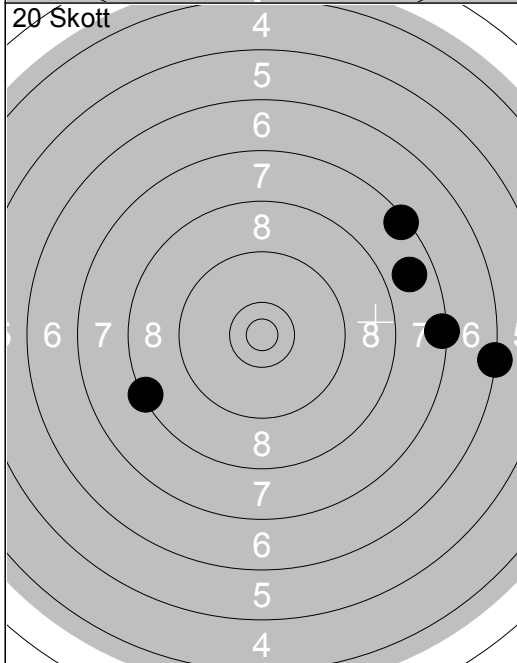

11:	6.3	→
12:	8.4	←
13:	7.8	↗
14:	7.4	→
15:	7.4	↗
Serie		35.0
Total		131.0

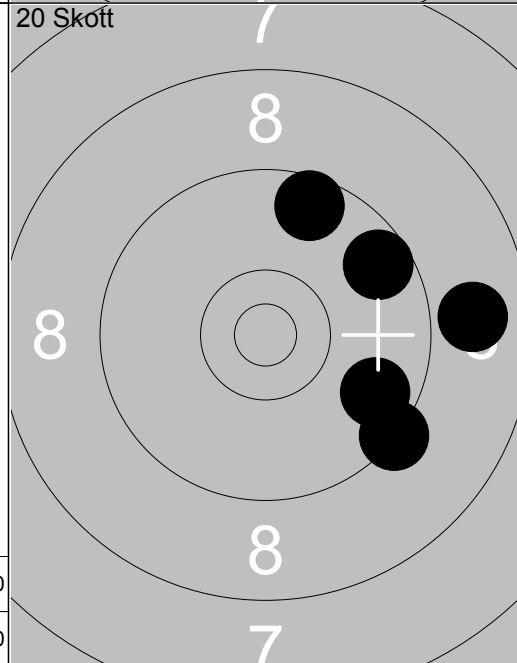

16:	9.3	↘
17:	9.6	↗
18:	9.6	↗
19:	9.7	↘
20:	8.9	→
Serie		44.0
Total		175.0

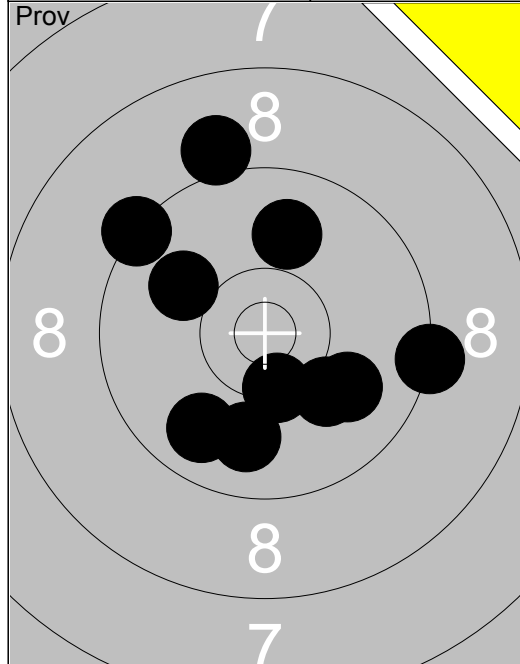

1:	9.3	→
2:	9.9	↑
3:	10.1	↘
4:	10.0	↘
5:	9.8	↙
6:	9.1	↑
7:	10.0	↖
8:	9.9	↘
9:	9.3	↖
10:	*10.4	↘
Serie		94.0
Total		0.0

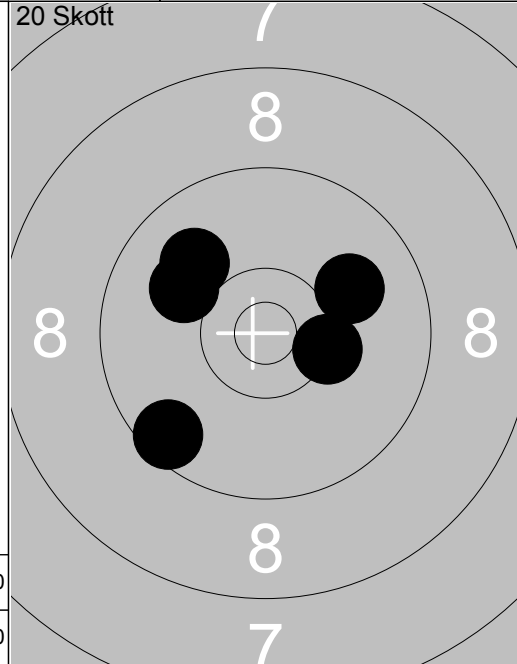

1:	*10.3	→
2:	10.0	↖
3:	10.0	↗
4:	9.5	↙
5:	10.0	↖
Serie		49.0
Total		49.0

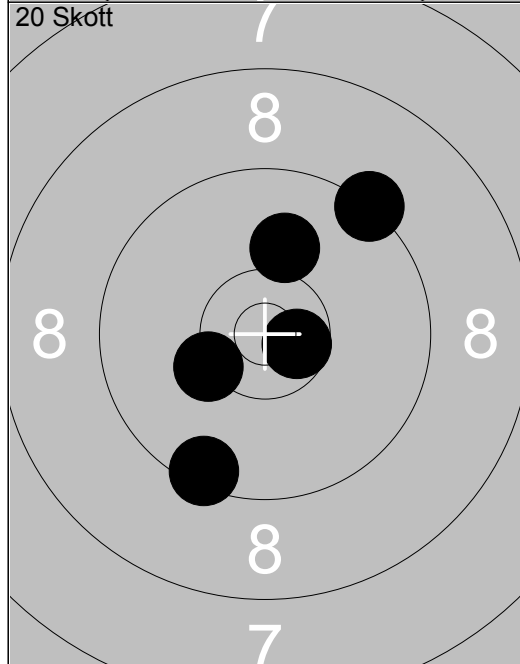

6:	*10.6	→
7:	*10.3	↖
8:	9.3	↗
9:	10.1	↑
10:	9.5	↘
Serie		48.0
Total		97.0

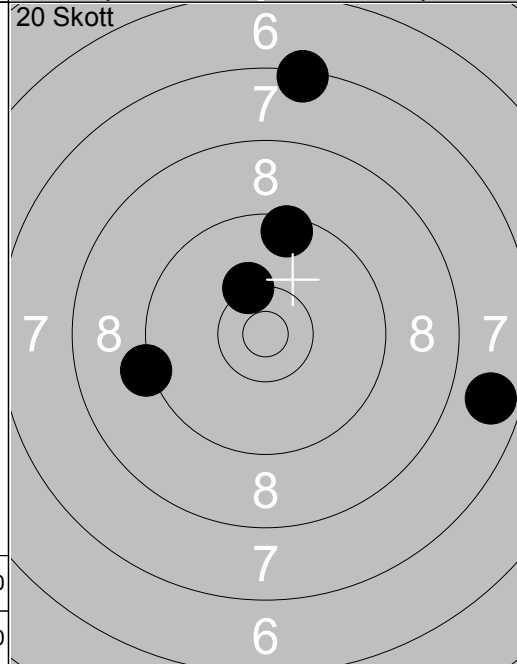

11:	9.2	↖
12:	10.3	↖
13:	9.5	↑
14:	7.7	→
15:	7.4	↑
Serie		42.0
Total		139.0

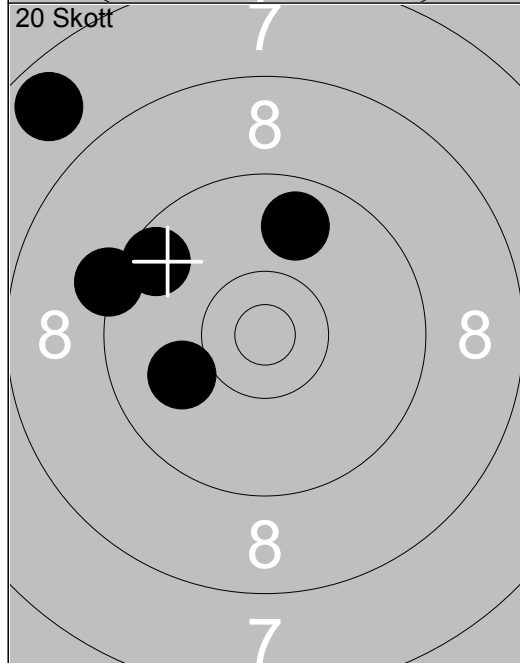

16:	7.7	↖
17:	9.3	↖
18:	10.0	↖
19:	9.6	↖
20:	9.8	↑
Serie		44.0
Total		183.0

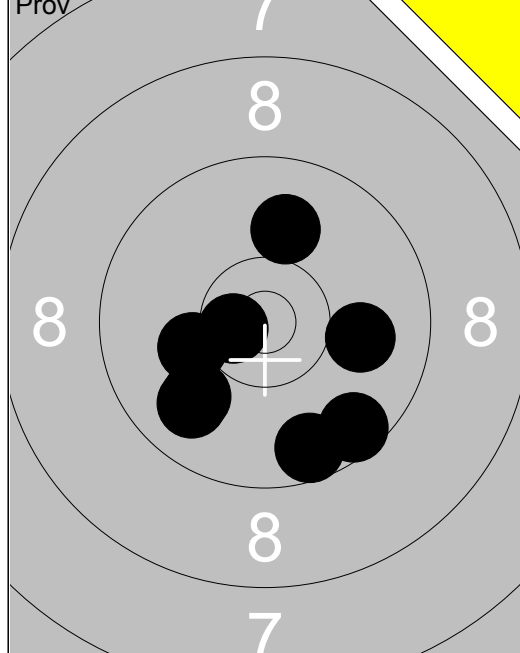

1:	9.9	↙
2:	10.2	←
3:	10.0	↑
4:	9.9	↙
5:	*10.6	←
6:	9.6	↘
7:	9.6	↘
8:	10.0	→
Serie		76.0
Total		0.0

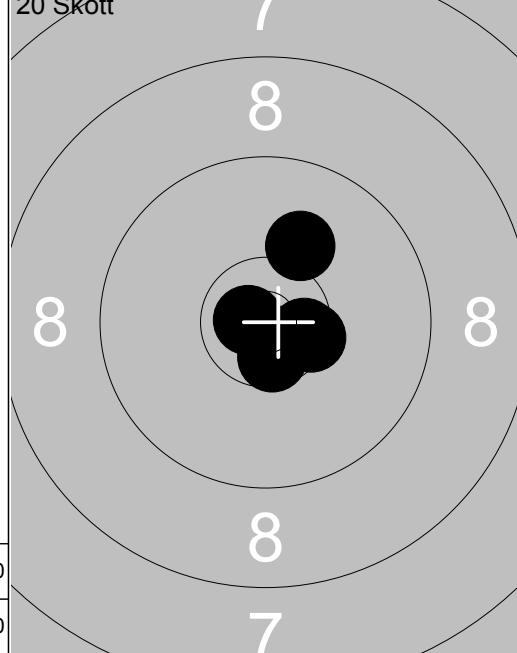

1:	10.1	↗
2:	*10.6	→
3:	*10.6	↘
4:	*10.5	→
5:	*10.8	←
Serie		50.0
Total		50.0

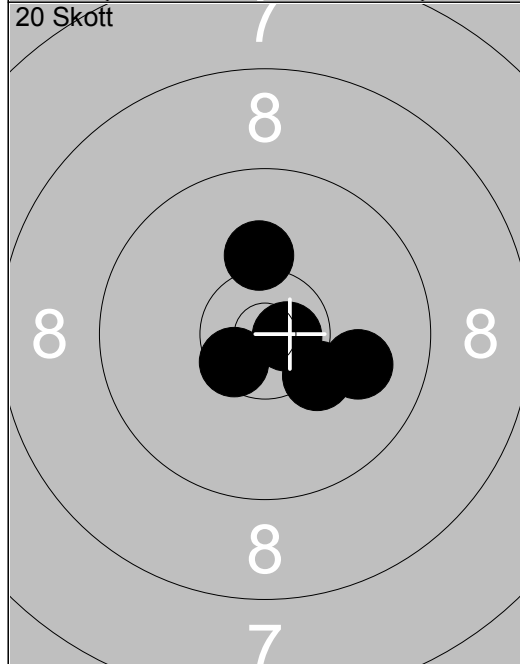

6:	10.0	→
7:	10.2	↑
8:	10.3	↘
9:	*10.5	↙
10:	*10.7	→
Serie		50.0
Total		100.0

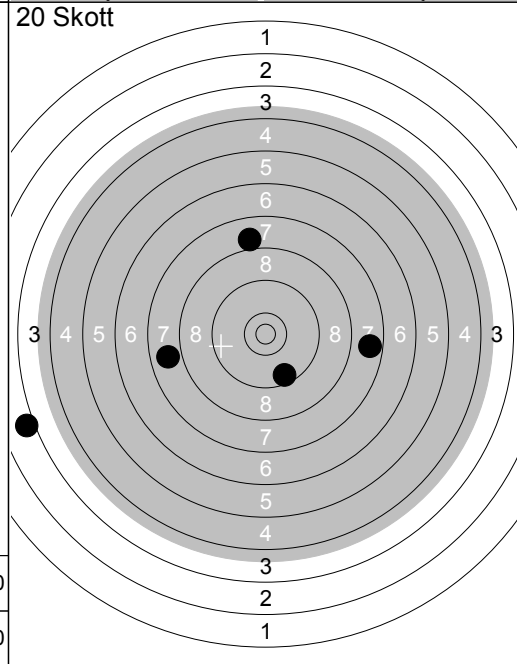

11:	7.7	→
12:	7.9	←
13:	9.6	↘
14:	3.0	←
15:	8.0	↑
Serie		34.0
Total		134.0

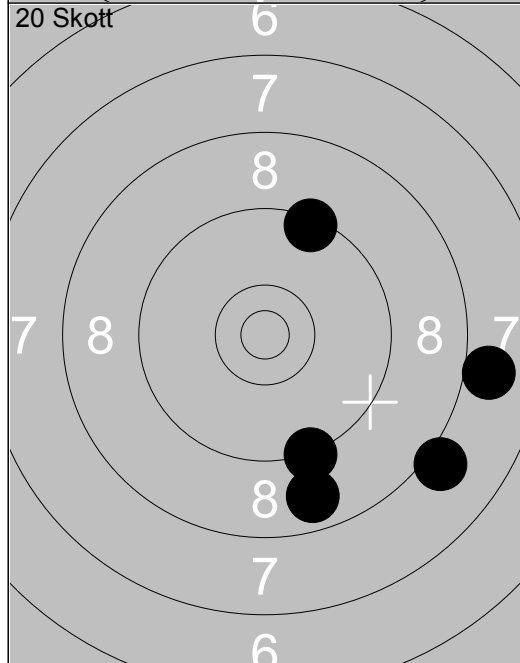

16:	8.8	↘
17:	8.0	→
18:	8.1	↘
19:	9.3	↘
20:	9.4	↗
Serie		42.0
Total		176.0

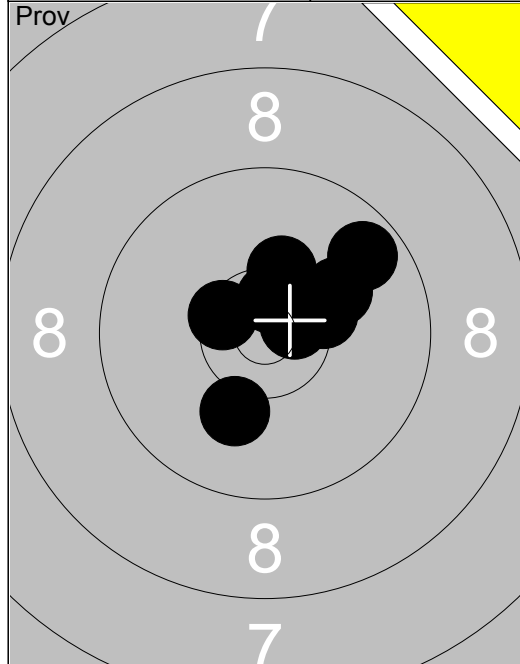

1:	*10.5	↖
2:	10.1	↓
3:	*10.6	↑
4:	10.1	↗
5:	*10.3	↑
6:	9.7	↗
7:	*10.6	→
8:	*10.3	→
Serie		79.0
Total		0.0

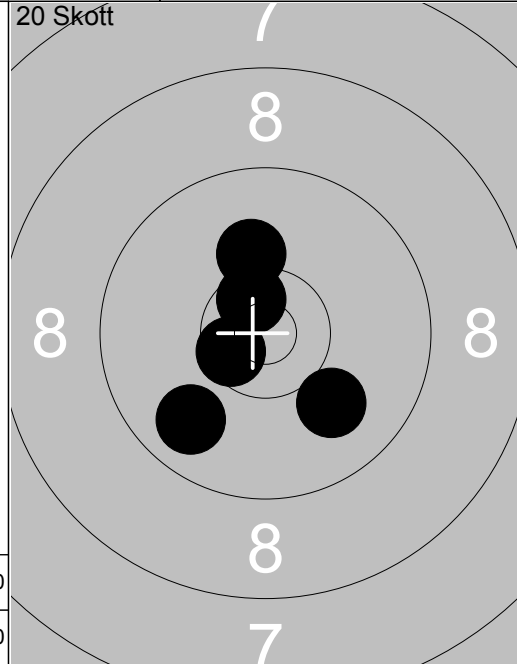

1:	9.8	↙
2:	10.0	↘
3:	*10.6	↖
4:	10.1	↑
5:	*10.6	↖
Serie		49.0
Total		49.0

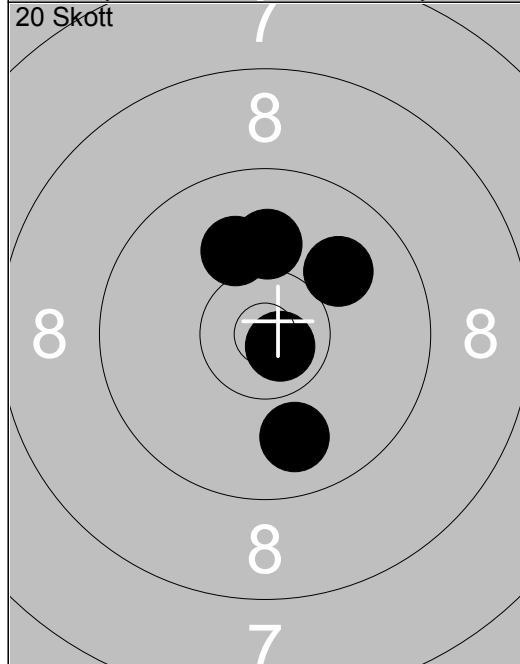

6:	10.1	↑
7:	9.9	↓
8:	10.0	↗
9:	10.1	↑
10:	*10.8	↘
Serie		49.0
Total		98.0

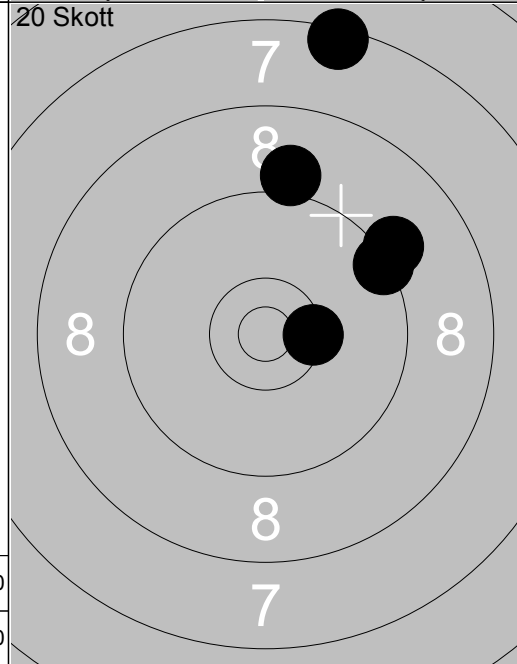

11:	9.2	↗
12:	7.4	↑
13:	9.4	↗
14:	9.1	↑
15:	*10.4	→
Serie		44.0
Total		142.0

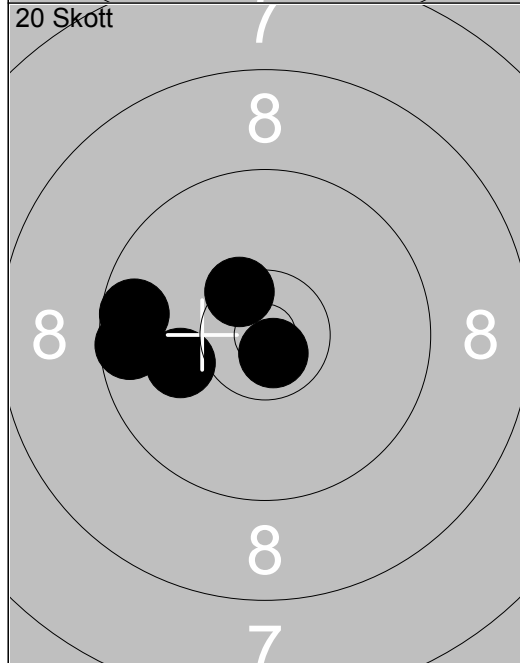

16:	*10.4	↖
17:	9.6	←
18:	9.6	←
19:	*10.8	↓
20:	10.1	←
Serie		48.0
Total		190.0

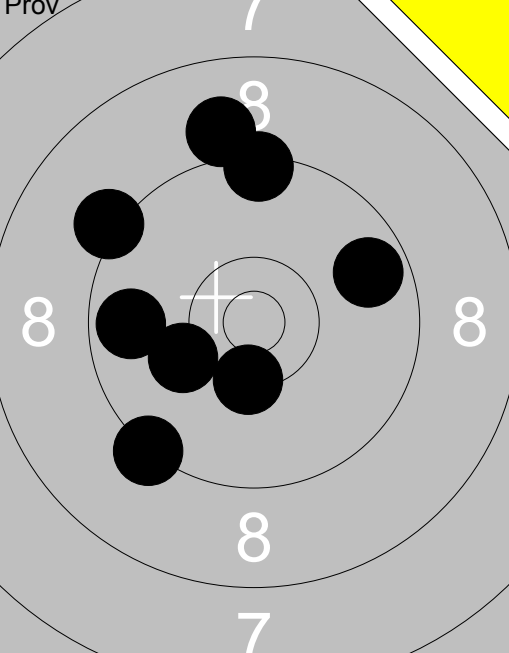
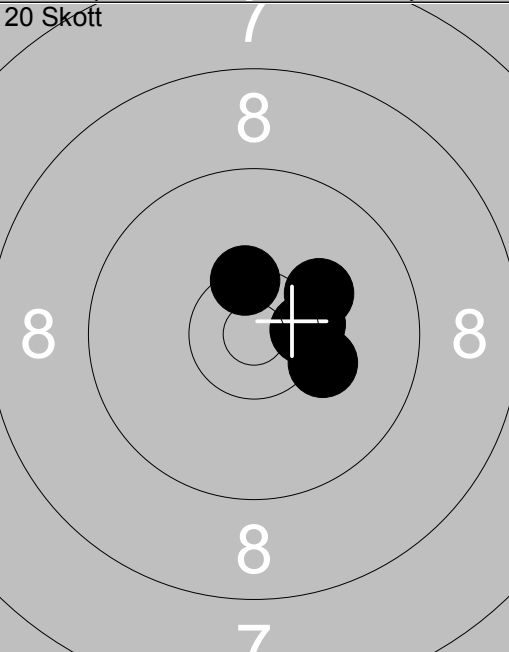
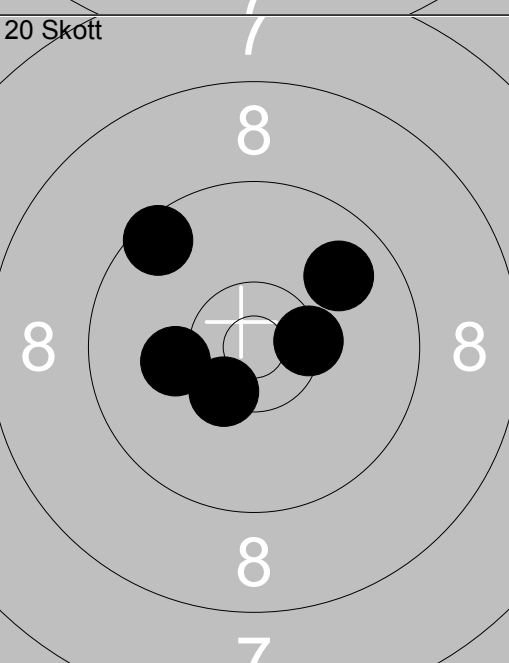
Prov 	20 Skott 	20 Skott 
1: 9.0 ↑ 2: 9.7 → 3: 9.7 ← 4: *10.4 ↓ 5: 10.2 ← 6: 9.2 ↖ 7: 9.3 ↙ 8: 9.4 ↑	6: *10.4 ↑ 7: 10.2 → 8: *10.4 → 9: *10.4 → 10: 10.2 ↗	11: 9.7 ↑ 12: 9.6 ← 13: 10.0 ↓ 14: *10.6 ↗ 15: *10.6 ↓
Serie 74.0 Total 0.0	Serie 50.0 Total 97.0	Serie 48.0 Total 145.0
1: 9.1 ← 2: 9.7 ↑ 3: 9.9 → 4: 10.2 ↓ 5: *10.5 ↓		
Serie 47.0 Total 47.0		Serie 47.0 Total 47.0

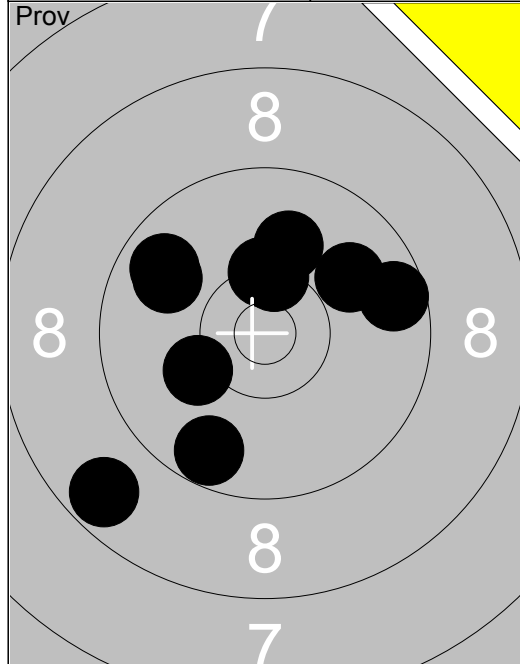

1:	*10.4	↑
2:	10.0	↑
3:	*10.3	↑
4:	9.8	↖
5:	9.8	↖
6:	10.2	↙
7:	9.6	→
8:	8.7	↙
9:	9.9	↗
10:	9.7	↘
Serie		93.0
Total		0.0

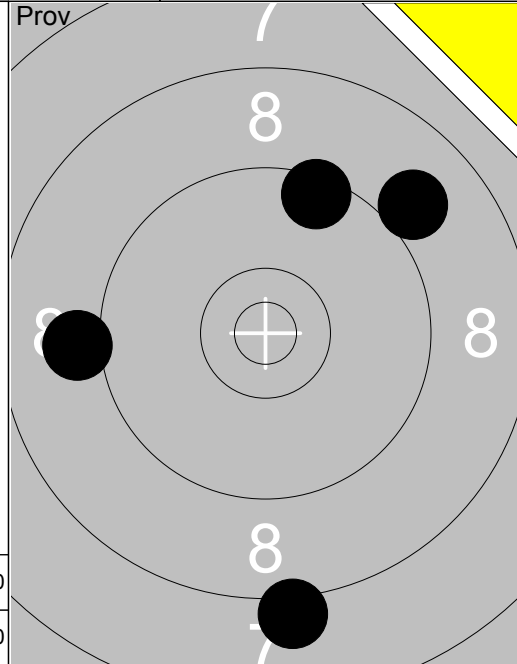

11:	9.5	↑
12:	9.1	←
13:	9.0	↗
14:	8.1	↓
Serie		35.0
Total		0.0

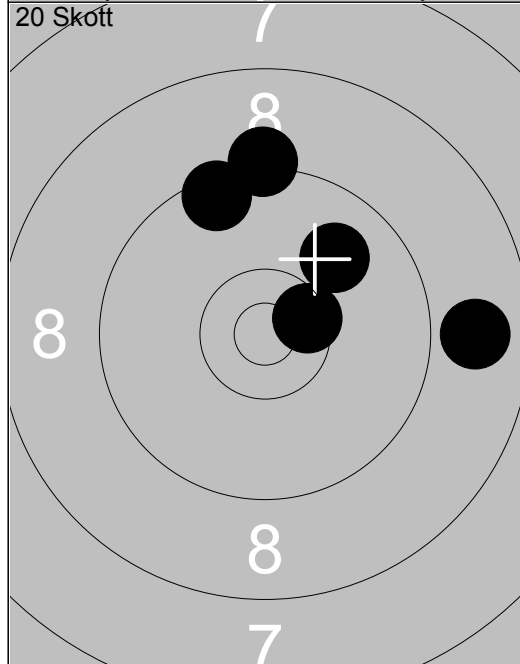

1:	*10.5	→
2:	8.9	→
3:	9.2	↑
4:	9.9	↗
5:	9.5	↑
Serie		45.0
Total		45.0

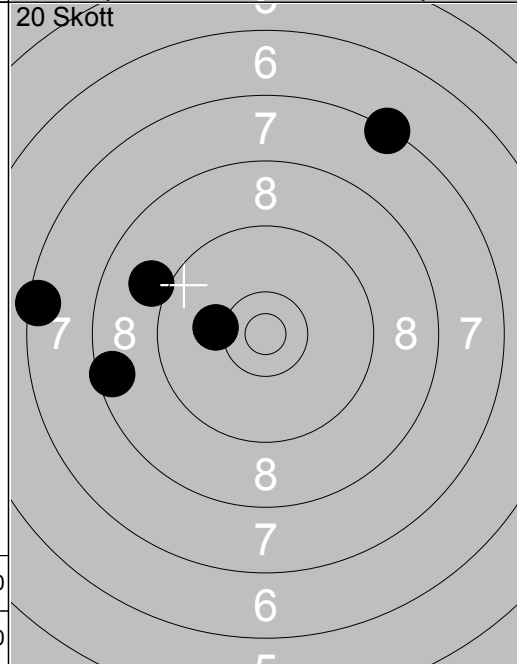

6:	10.2	←
7:	7.4	←
8:	7.3	↗
9:	9.0	←
10:	8.5	←
Serie		41.0
Total		86.0

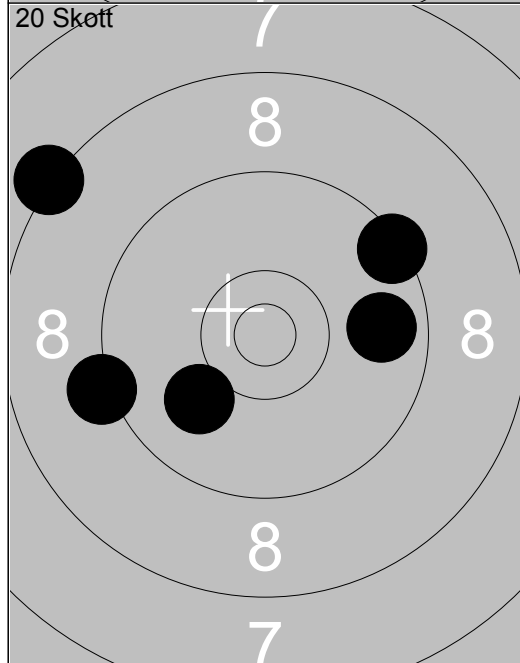

11:	9.2	←
12:	8.3	↖
13:	10.0	↙
14:	9.8	→
15:	9.4	↗
Serie		45.0
Total		131.0

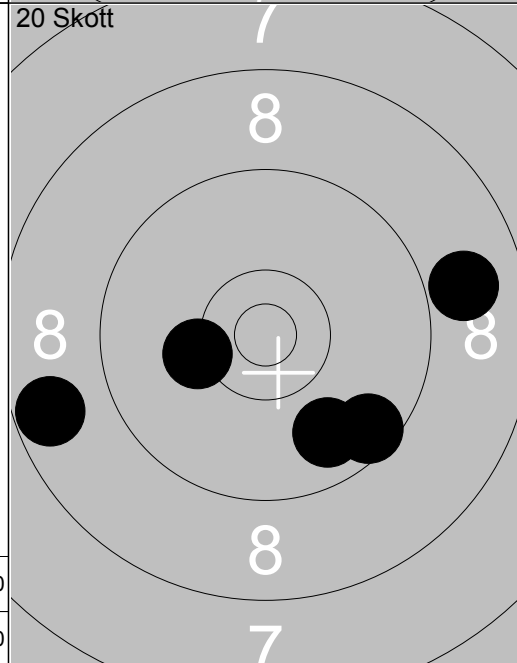

16:	9.8	↘
17:	8.9	→
18:	10.2	←
19:	9.6	↘
20:	8.7	←
Serie		44.0
Total		175.0