

1:10,3*	←
2:10,2*	↗
3:10,5*	↗
4: 9,9	↖
5:10,6*	↘

**Serie: 51,5**

**Summa: 468,9**

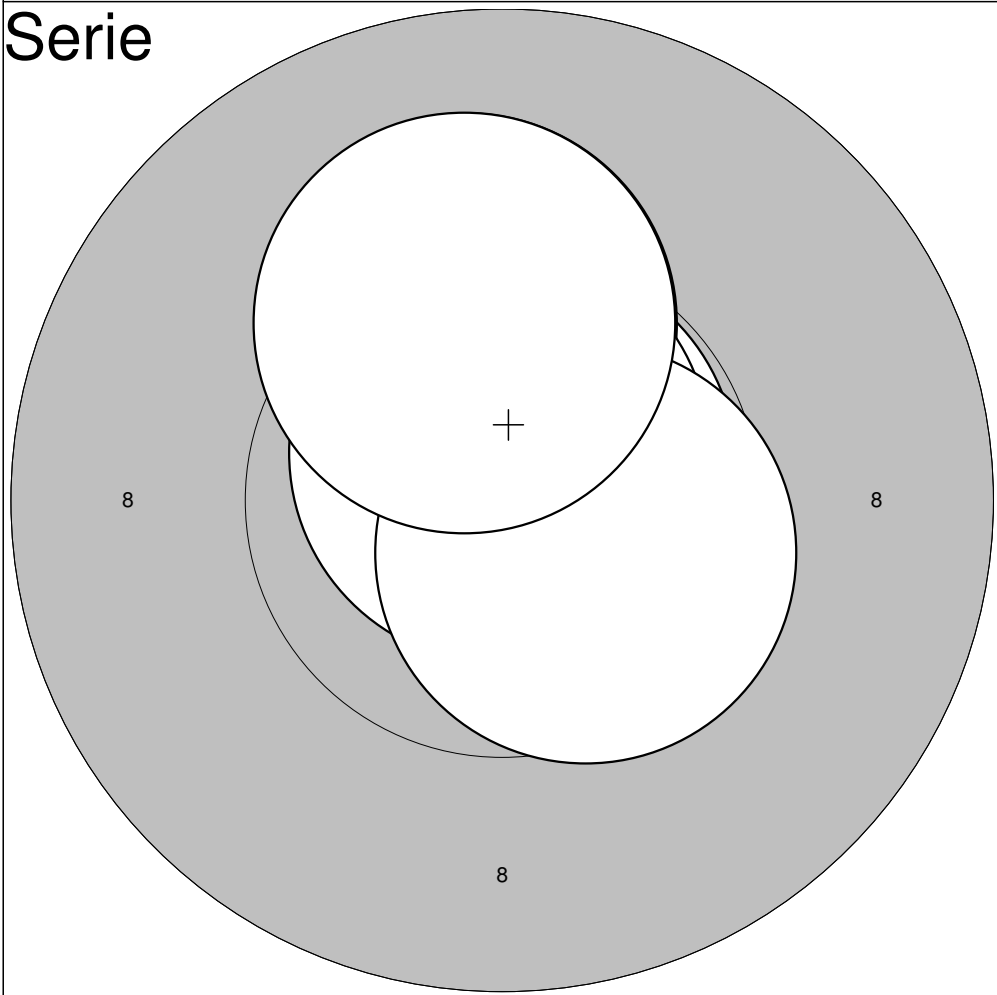

6:10,8*	↗
7:10,2*	↑
8:10,7*	↑
9:10,5*	↘
10:10,2*	↑

**Serie: 52,4**

**Summa: 521,3**

**Serie**

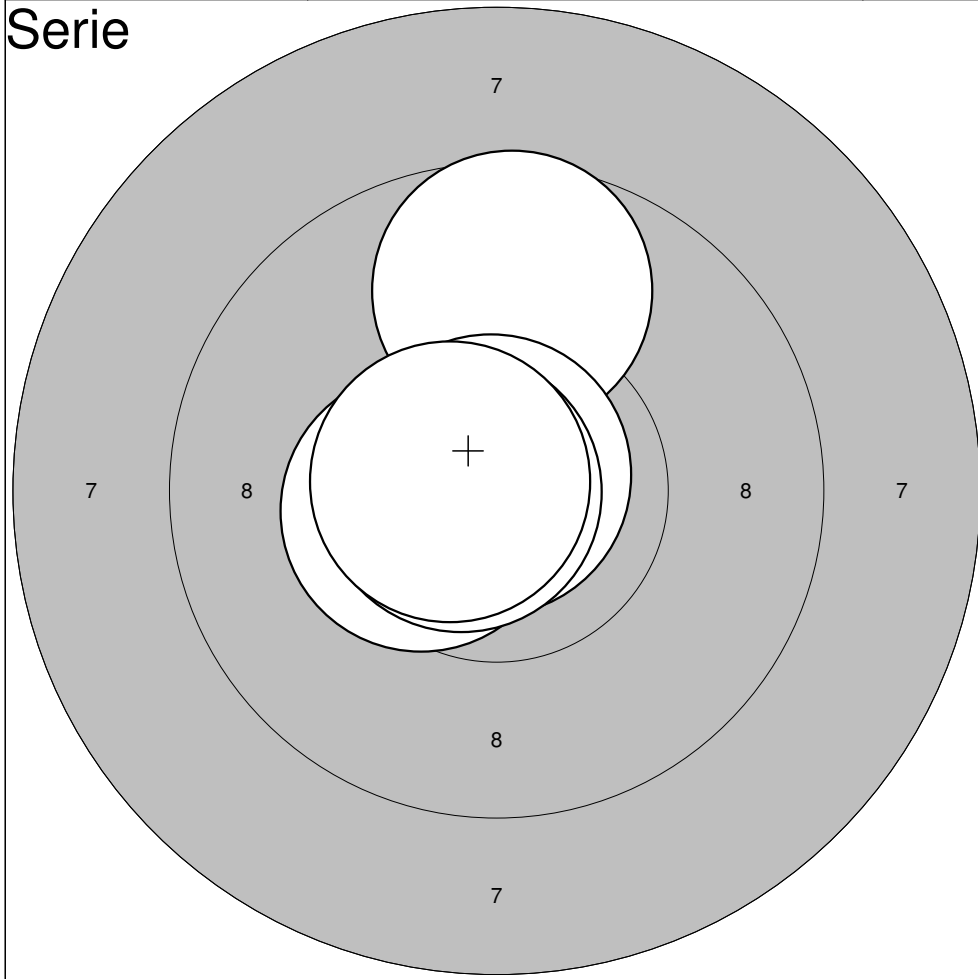

1: 9,7	↑
2: 10,4*	←
3: 10,8*	↑
4: 10,7*	←
5: 10,6*	←

**Serie: 52,2**

**Summa: 468,2**

**Serie**

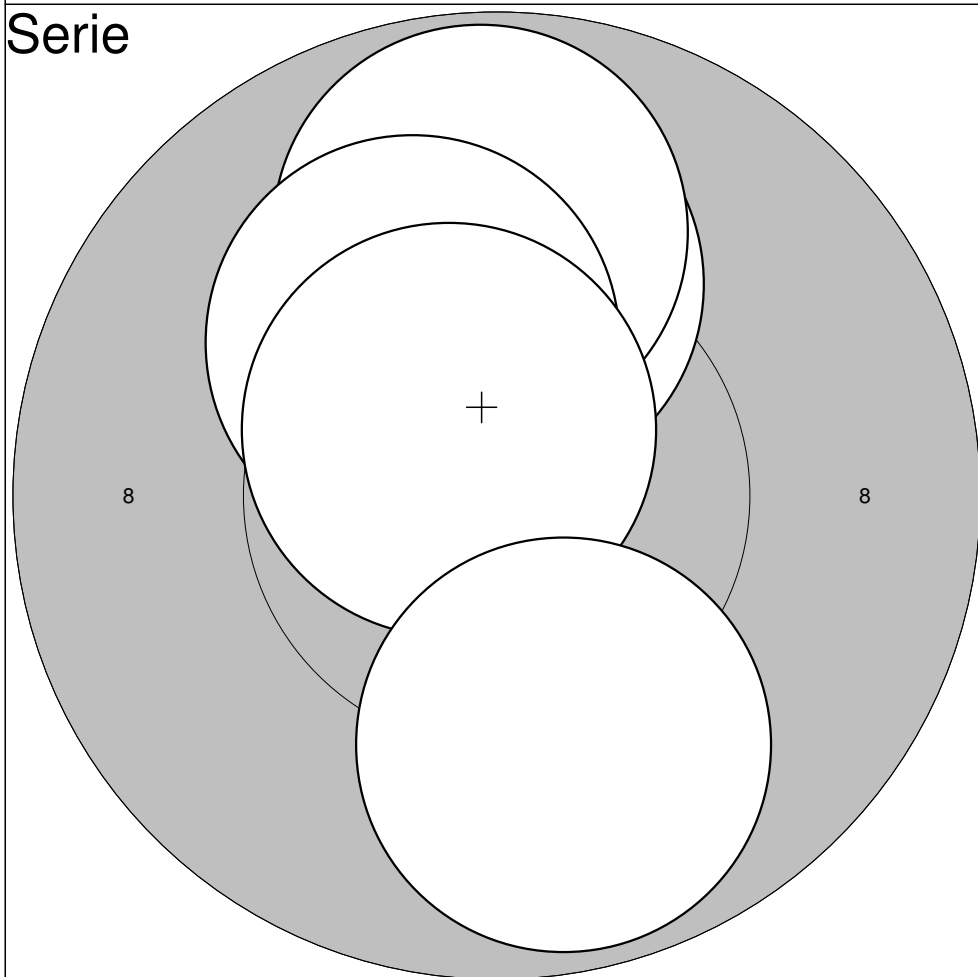

6: 10,0	↑
7: 9,8	↑
8: 10,2*	↗
9: 10,6*	↗
10: 9,8	↘

**Serie: 50,4**

**Summa: 518,6**

**Serie**

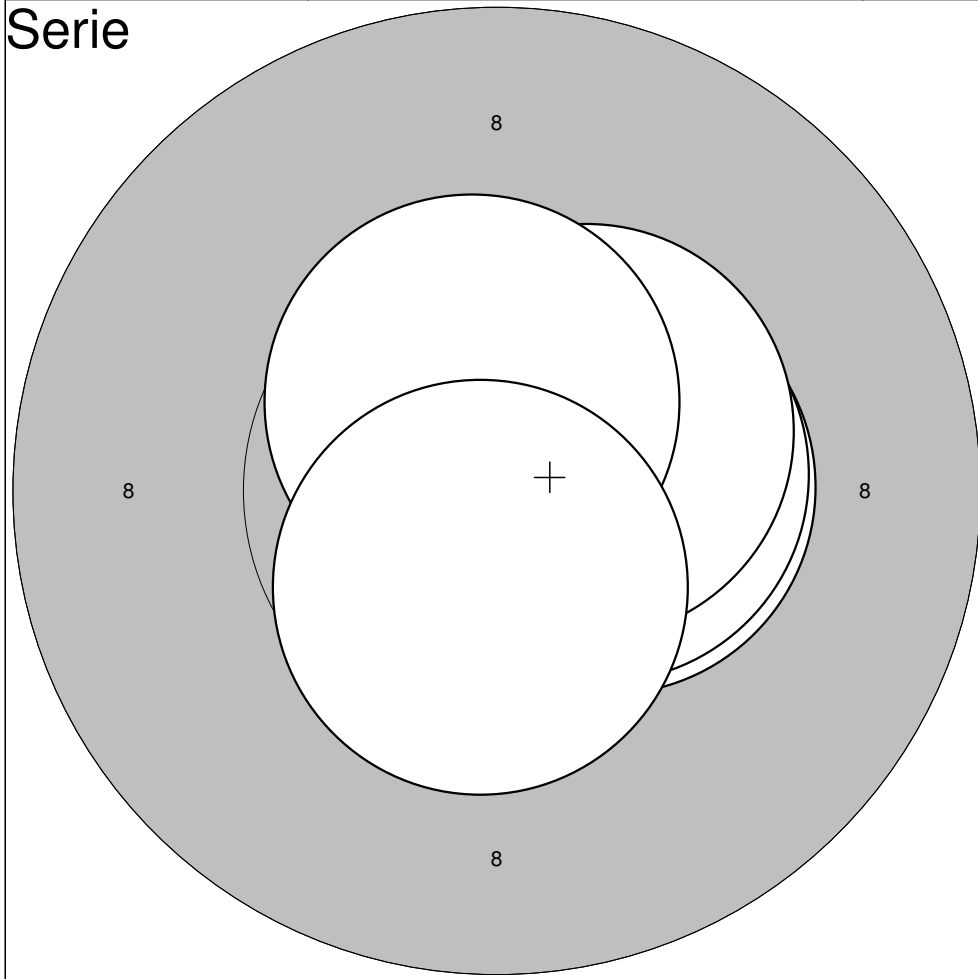

1:10,5*	→
2:10,5*	→
3:10,5*	↗
4:10,6*	↑
5:10,5*	↓

**Serie: 52,6**

**Summa: 468,5**

**Serie**

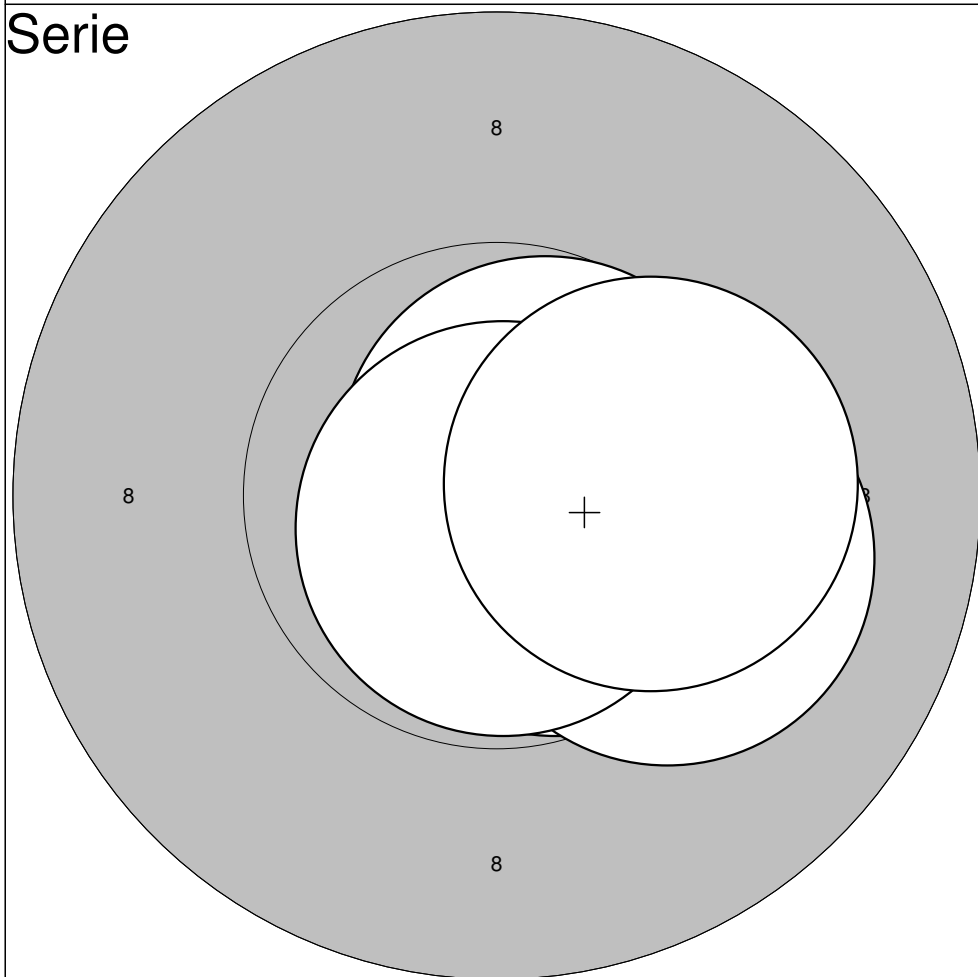

6:10,7*	↗
7:10,7*	↘
8:10,2*	↘
9:10,8*	↓
10:10,3*	→

**Serie: 52,7**

**Summa: 521,2**

**Serie**

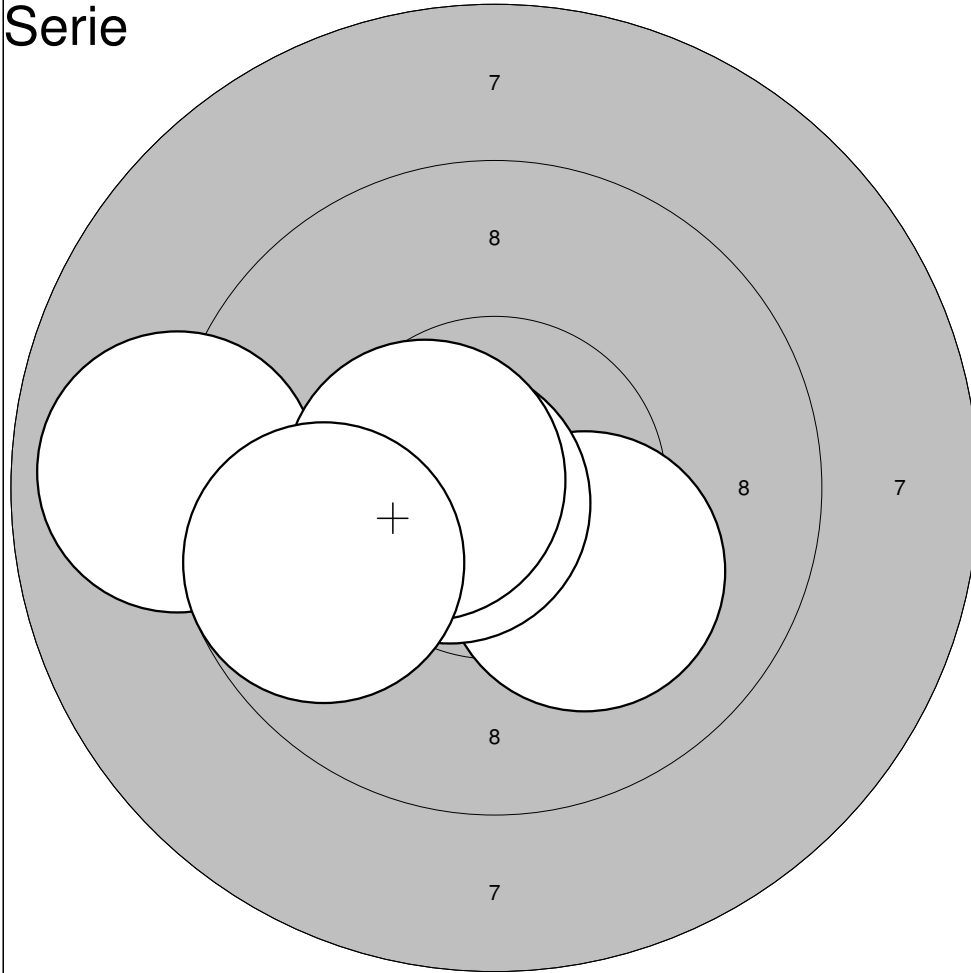

- 1: 10,2\* ↘
- 2: 10,6\* ←
- 3: 8,9 ←
- 4: 10,5\* ←
- 5: 9,8 ←

**Serie: 50,0**

**Summa: 465,6**

**Serie**

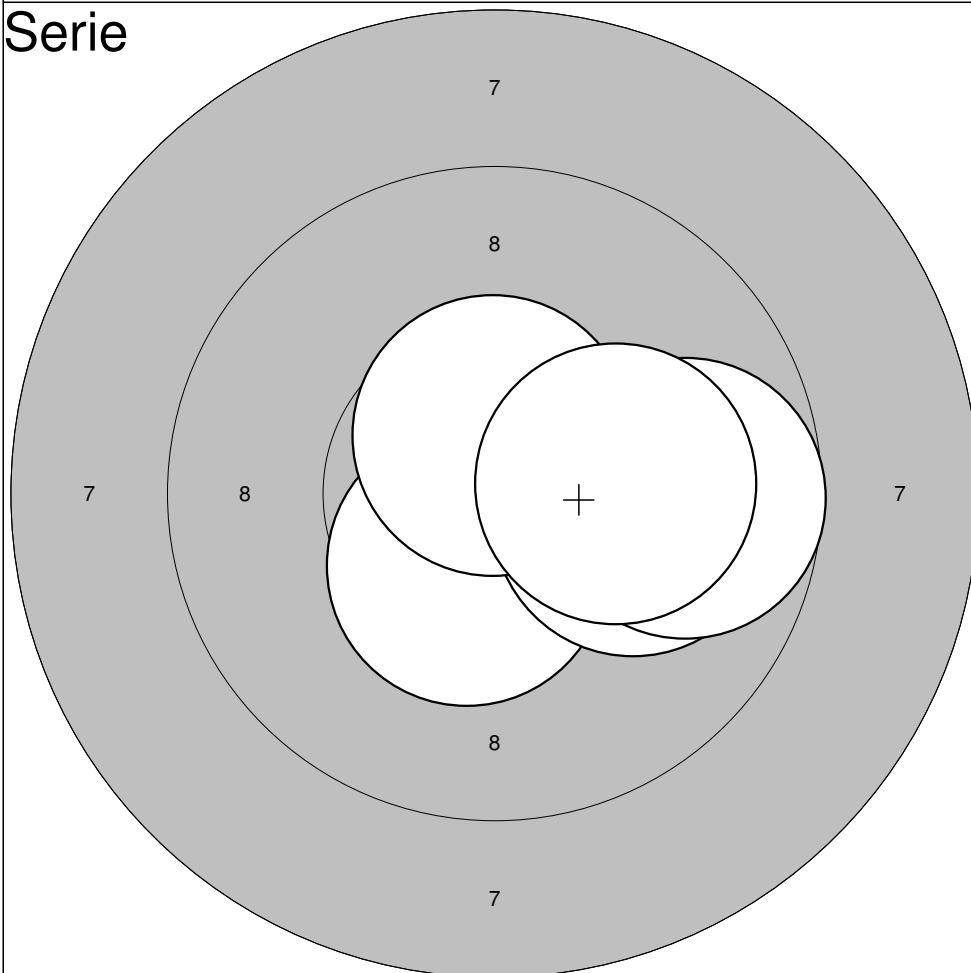

- 6: 10,5\* ↘
- 7: 10,0 →
- 8: 10,6\* ↑
- 9: 9,7 →
- 10: 10,2\* →

**Serie: 51,0**

**Summa: 516,6**

**Serie**

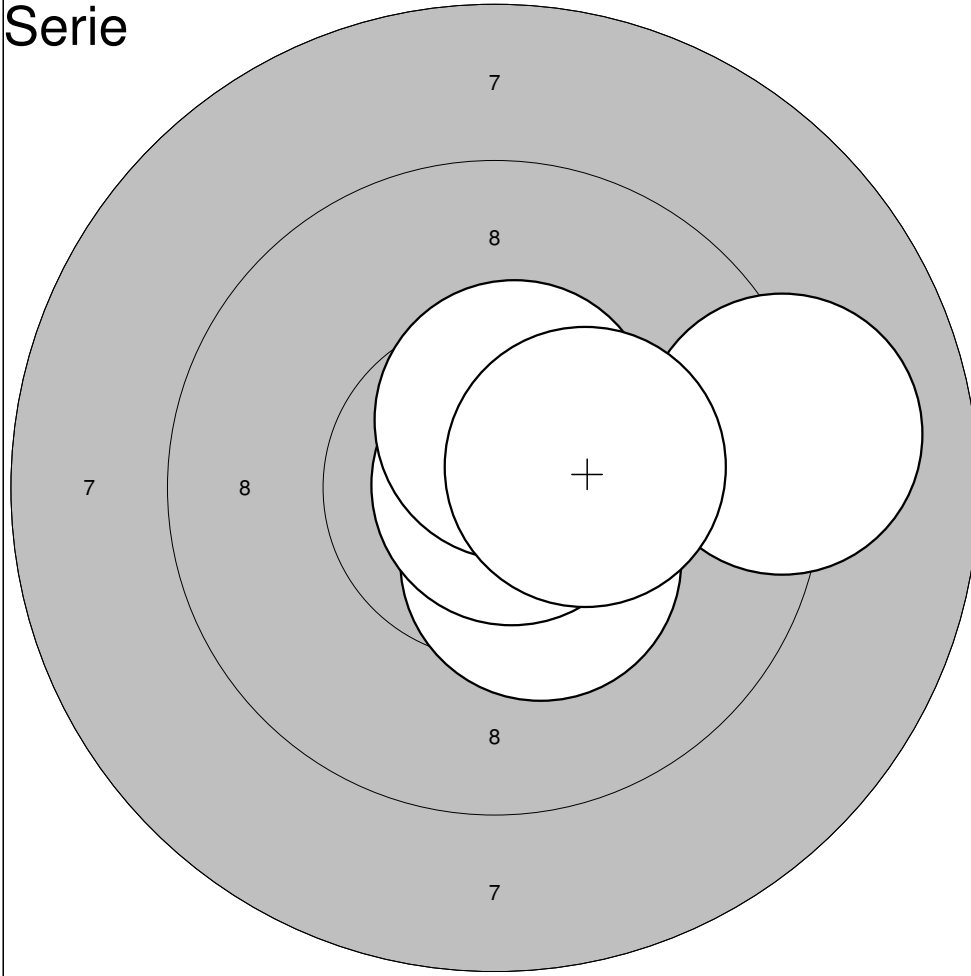

1:10,4*	↘
2:10,8*	→
3: 9,1	→
4:10,5*	↑
5:10,4*	→

**Serie: 51,2**

**Summa: 466,7**

**Serie**

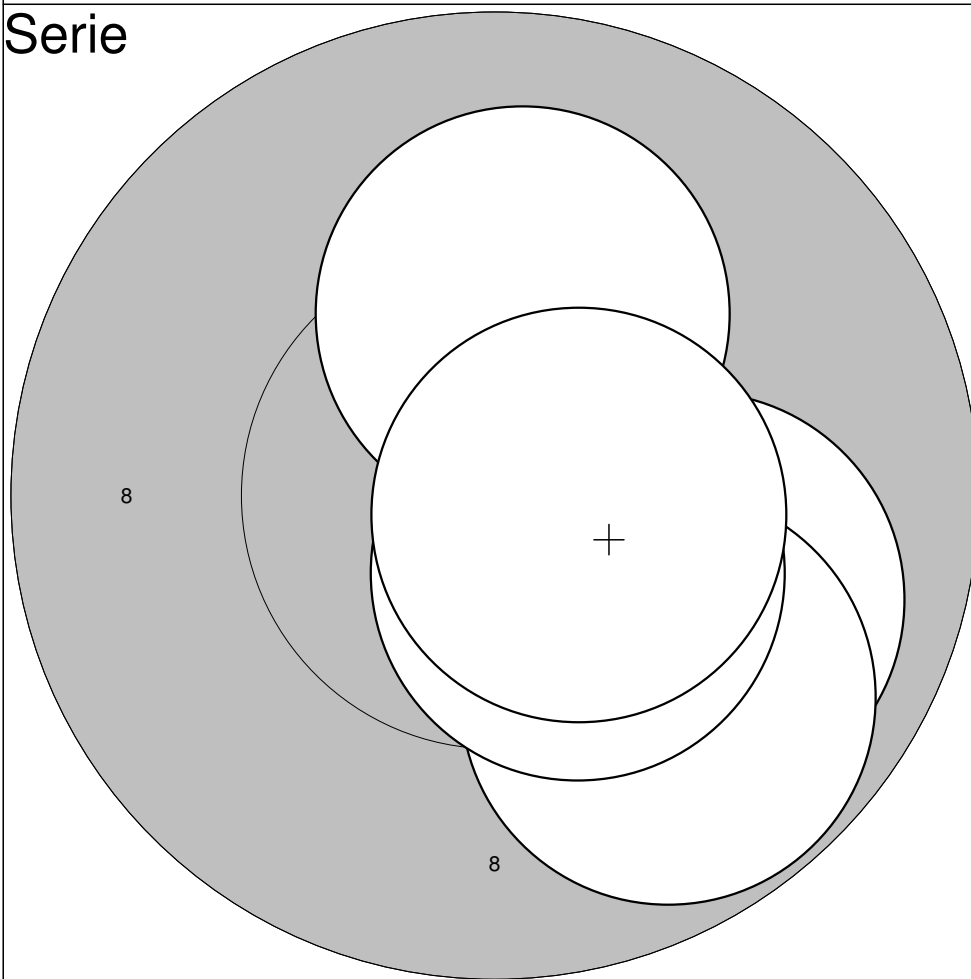

6:10,0	↘
7: 9,8	↘
8:10,5*	↘
9:10,2*	↑
10:10,6*	→

**Serie: 51,1**

**Summa: 517,8**

**Serie**

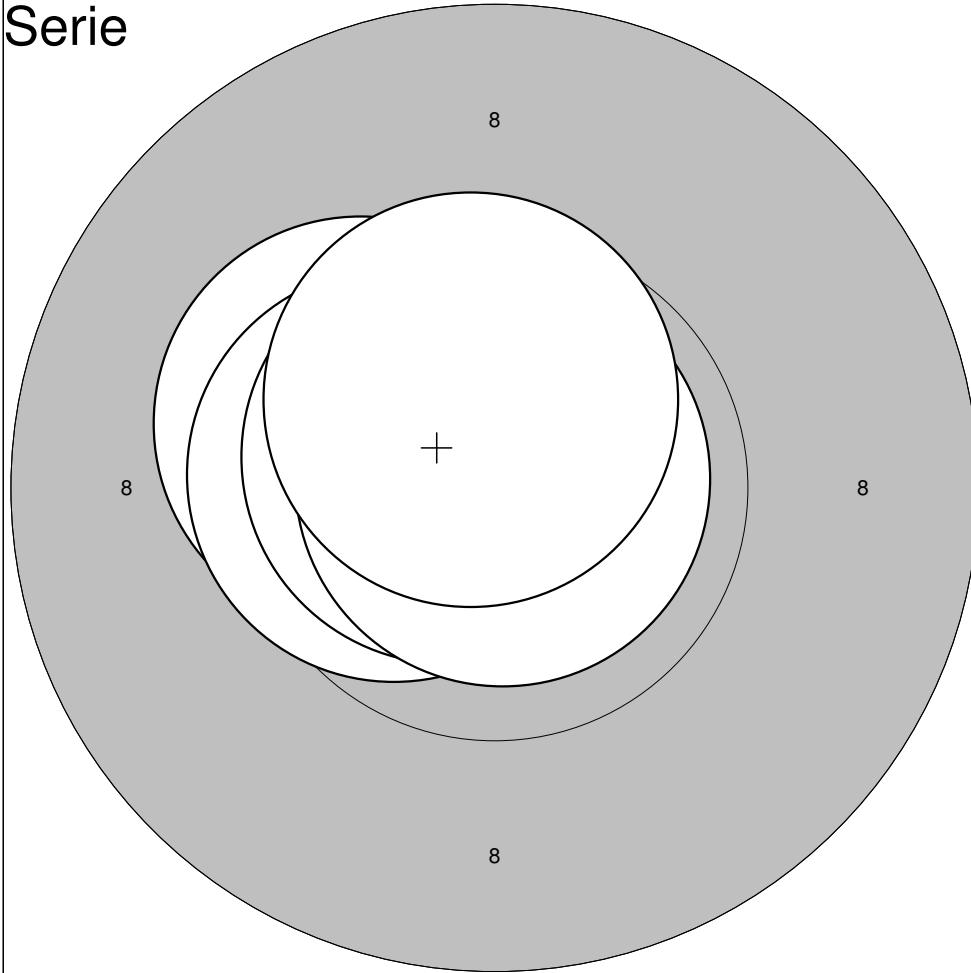

- 1:10,3\* ↖
- 2:10,5\* ←
- 3:10,7\* ↖
- 4:10,9\* ↗
- 5:10,6\* ↗

**Serie: 53,0**

**Summa: 467,1**

**Serie**

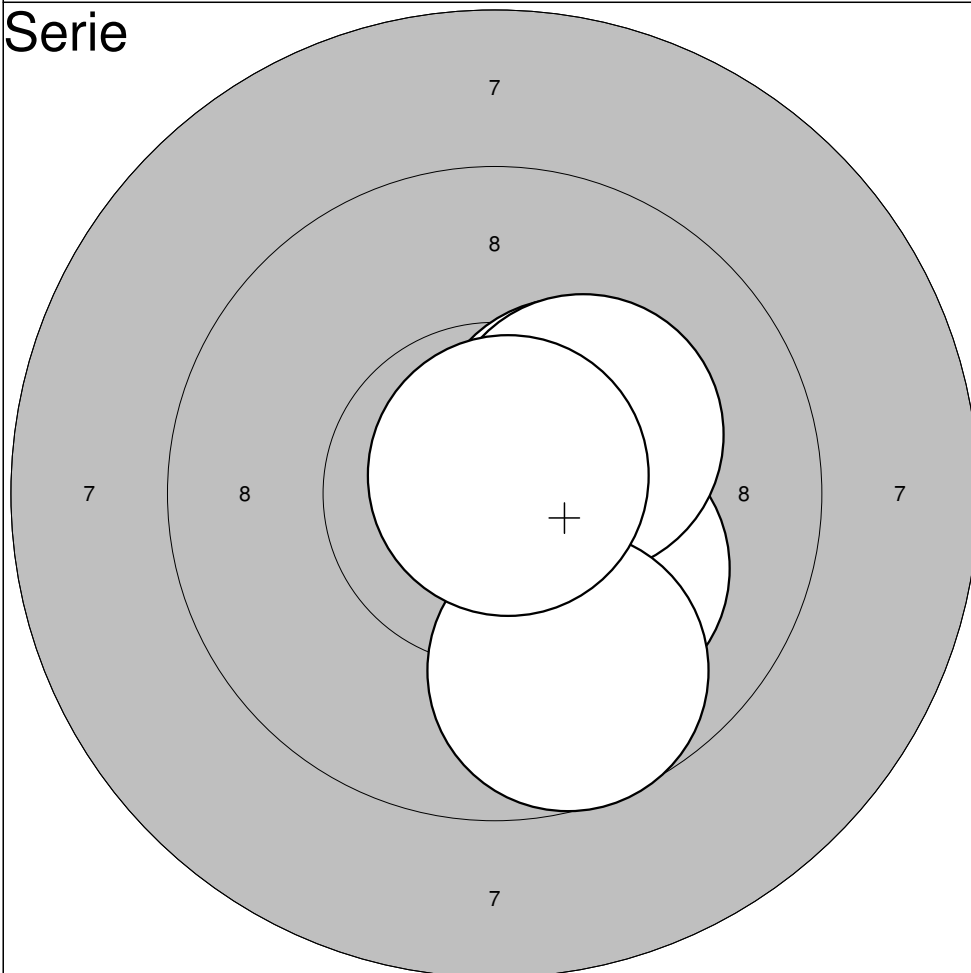

- 6:10,2\* ↘
- 7:10,3\* ↗
- 8:10,3\* ↗
- 9: 9,7 ↘
- 10:10,8\* ↗

**Serie: 51,3**

**Summa: 518,4**

### Serie

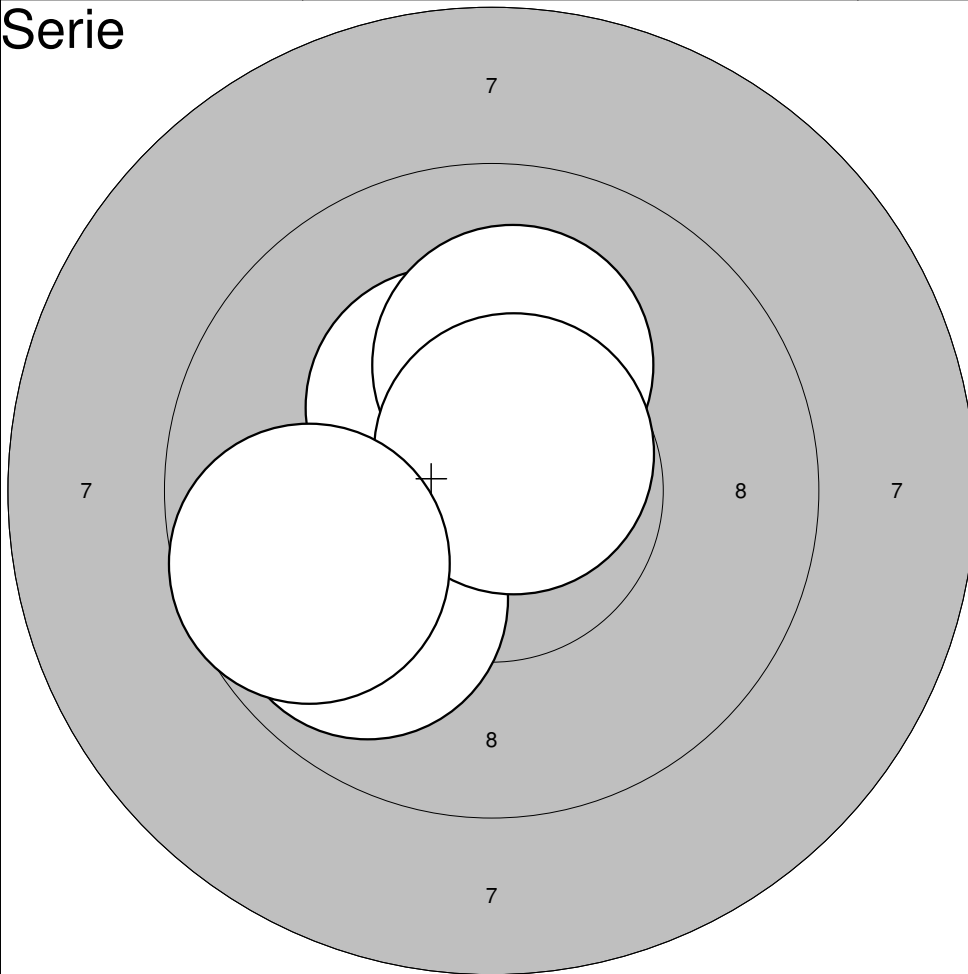

- 1: 9,9 ↙
- 2: 10,3\* ↖
- 3: 10,1 ↑
- 4: 10,7\* ↗
- 5: 9,7 ↙

Serie: 50,7

Summa: 464,3

### Serie

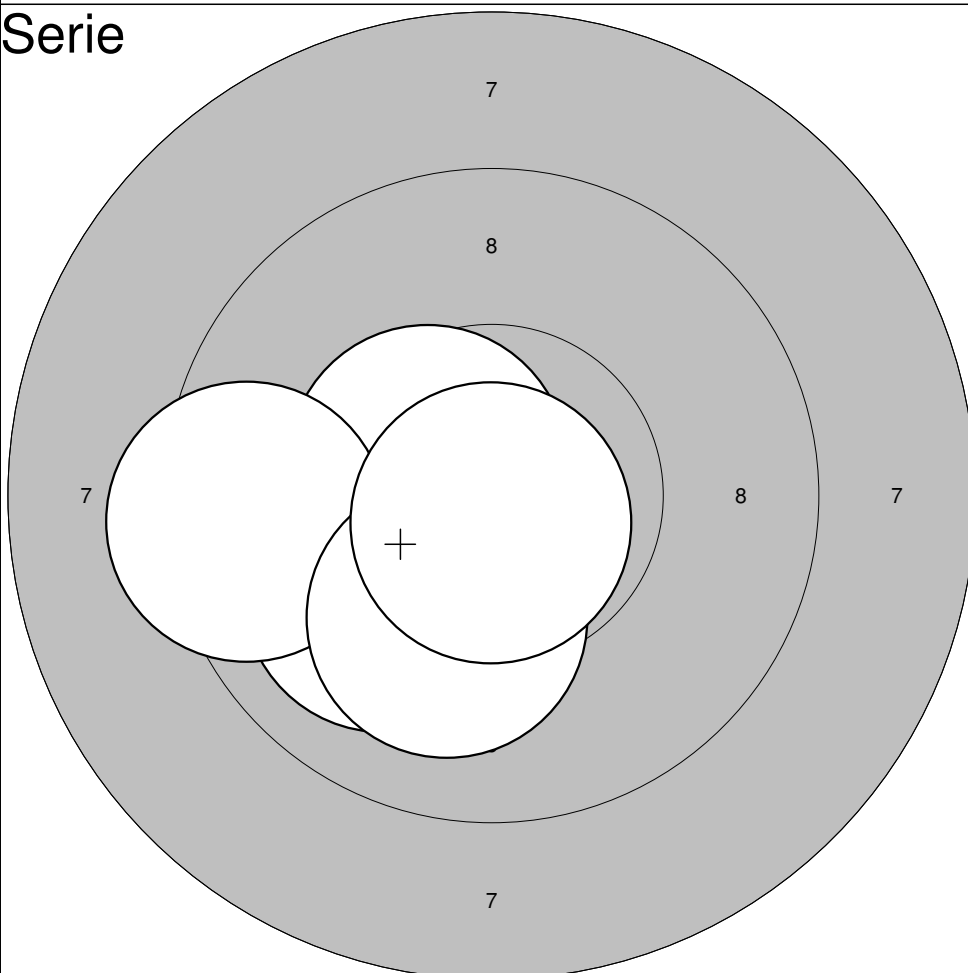

- 6: 10,0 ↙
- 7: 10,5\* ↖
- 8: 9,4 ←
- 9: 10,1 ↘
- 10: 10,8\* ↓

Serie: 50,8

Summa: 515,1

**Serie**

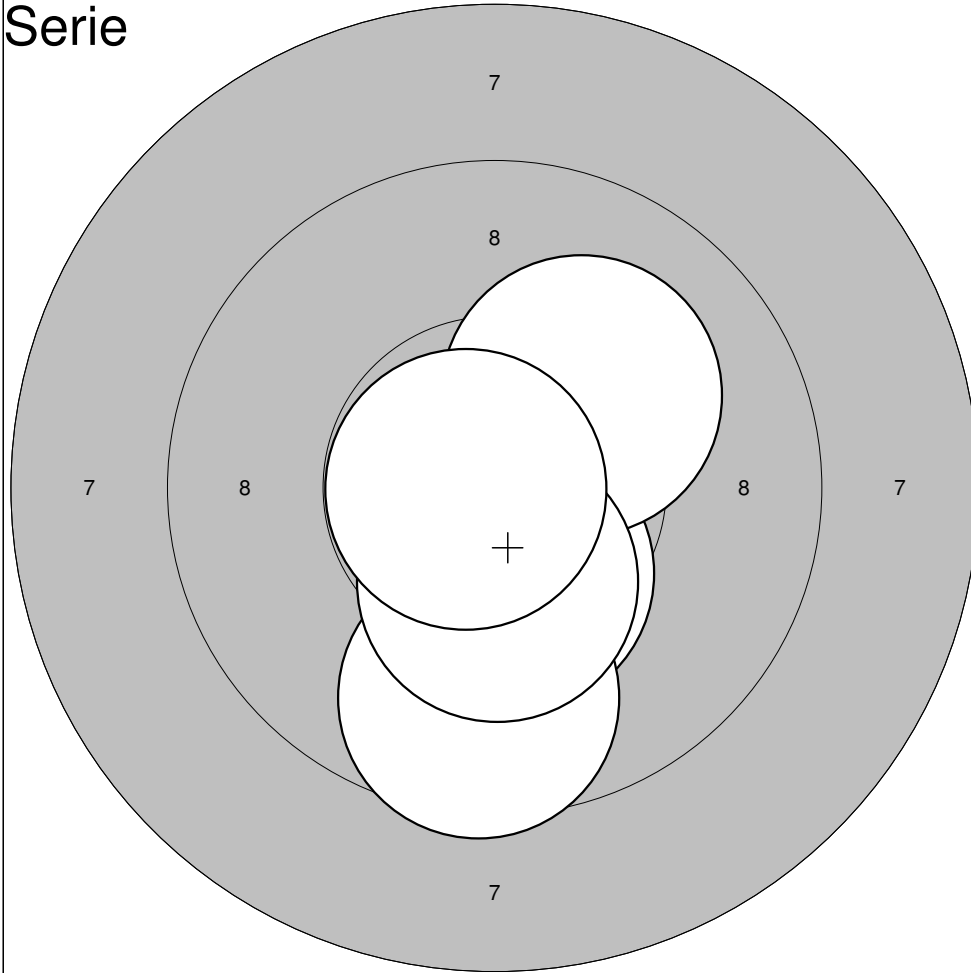

- 1: 10,4\* ↓
- 2: 9,6 ↓
- 3: 10,1 ↗
- 4: 10,3\* ↓
- 5: 10,8\* ←

**Serie: 51,2**

**Summa: 461,6**

**Serie**

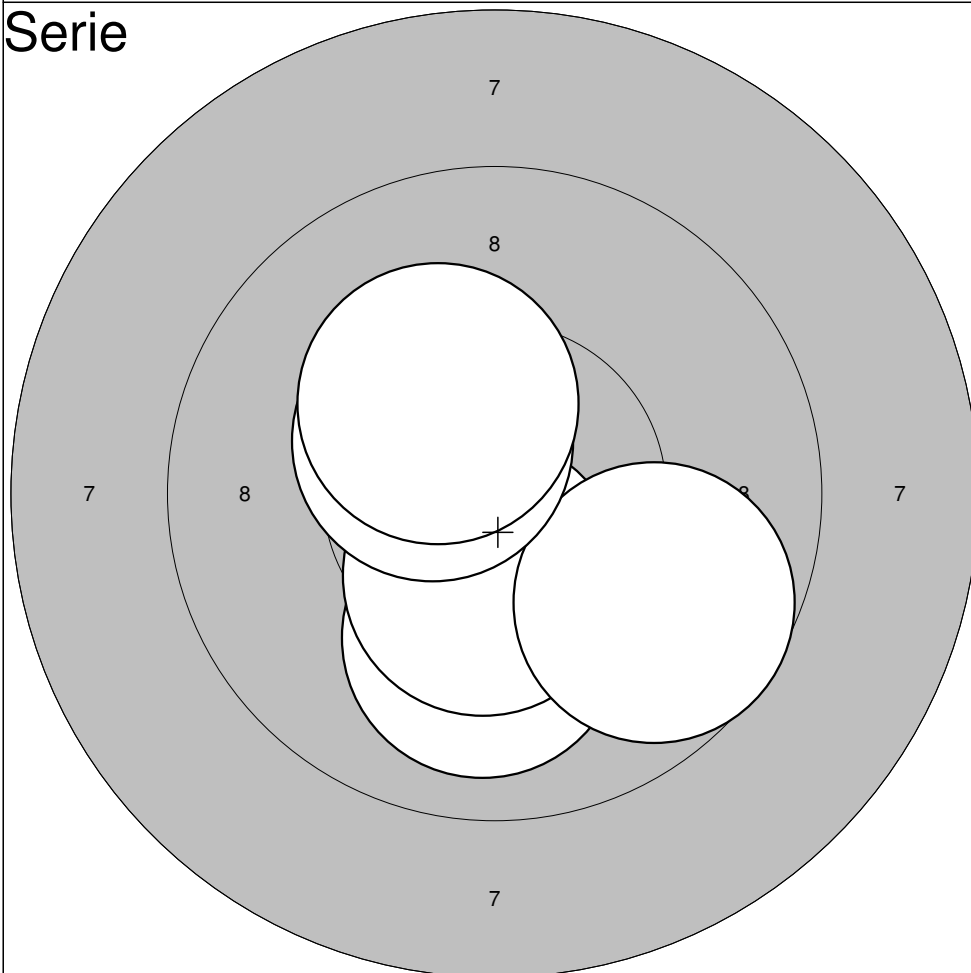

- 6: 10,0 ↓
- 7: 10,4\* ↓
- 8: 9,7 ↘
- 9: 10,4\* ↗
- 10: 10,3\* ↗

**Serie: 50,8**

**Summa: 512,4**



**Serie**

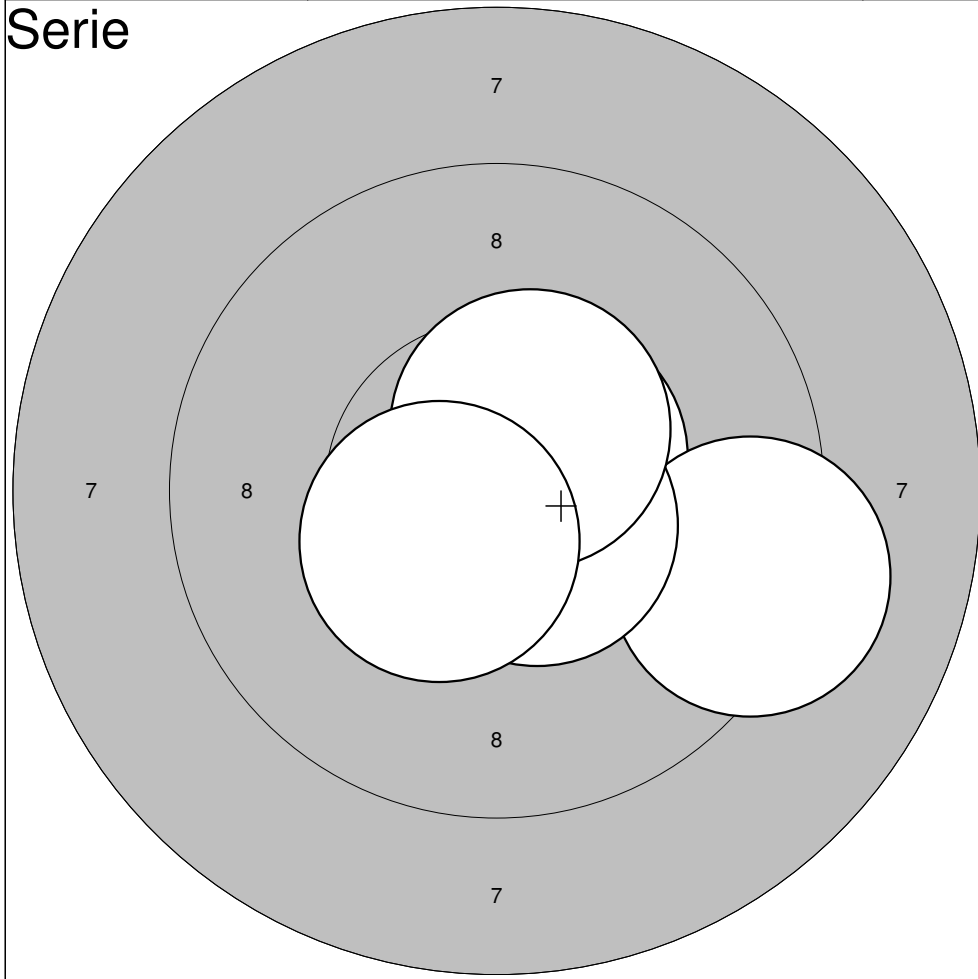

1: 10,6*	↗
2: 9,2	→
3: 10,6*	↘
4: 10,5*	↗
5: 10,5*	↙

Serie:	51,4
Summa:	461,0

**Serie**

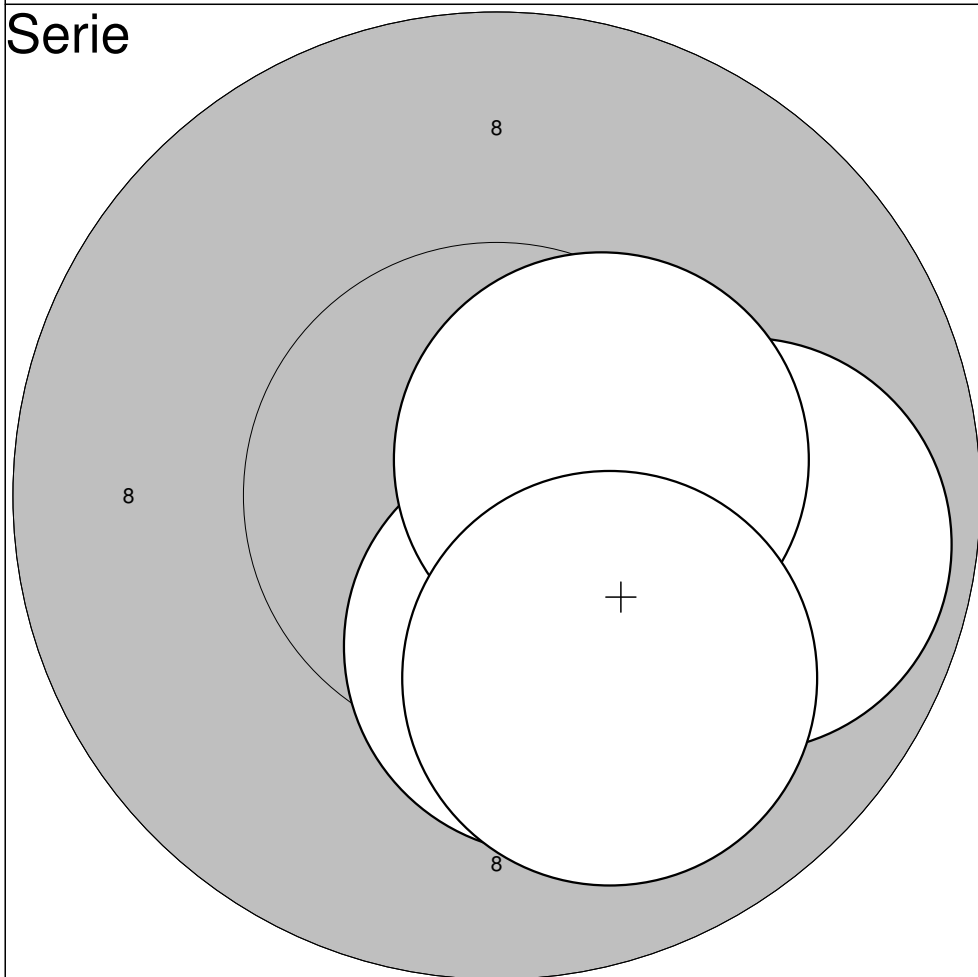

6: 9,9	→
7: 10,1	↘
8: 10,3*	↘
9: 10,5*	↗
10: 10,0	↘

Serie:	50,8
Summa:	511,8

Lag  
**7**Tavla  
**11****Sten-Åke Andersson**

Eringsboda-Backaryd

Vet sitt

31.10.2009

Final

swedishcup 09

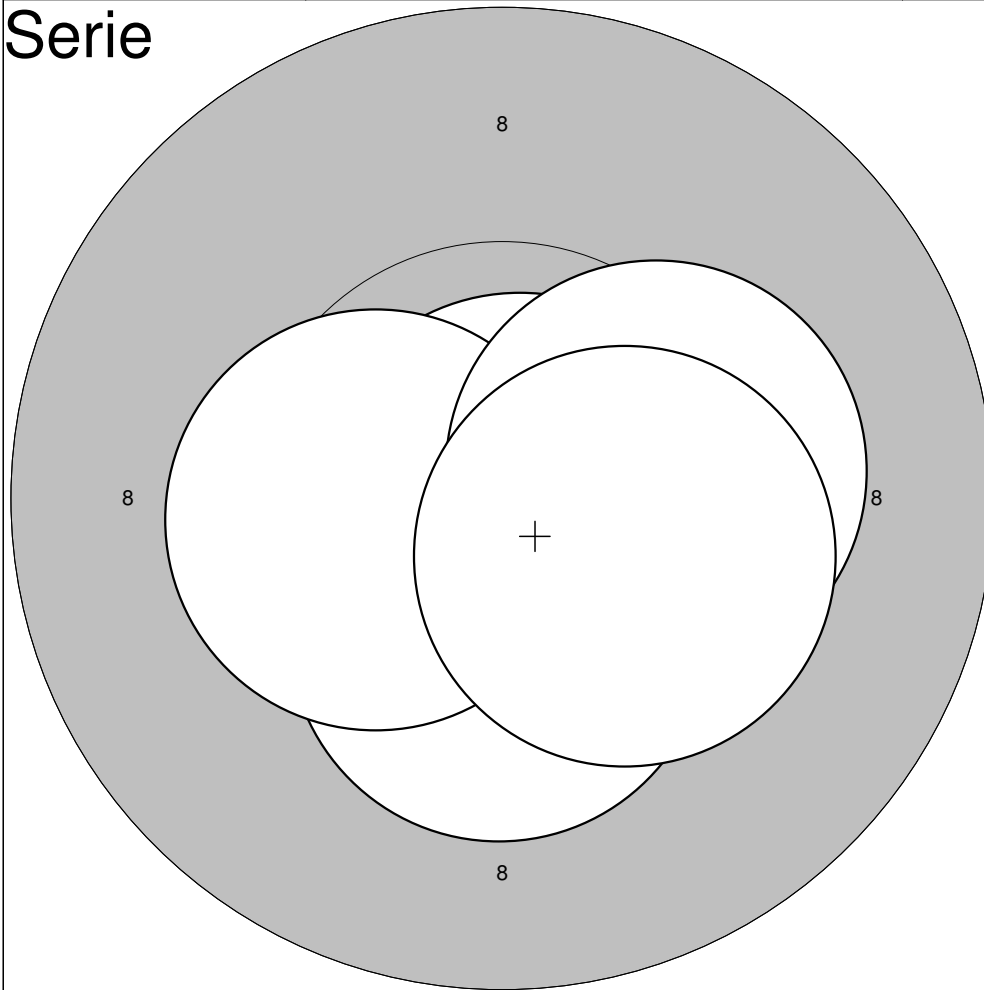
**Serie**

1:10,9\* →

2:10,4\* ↓

3:10,4\* ←

4:10,3\* →

5:10,4\* ↘

Serie: 52,4

Summa: 472,0

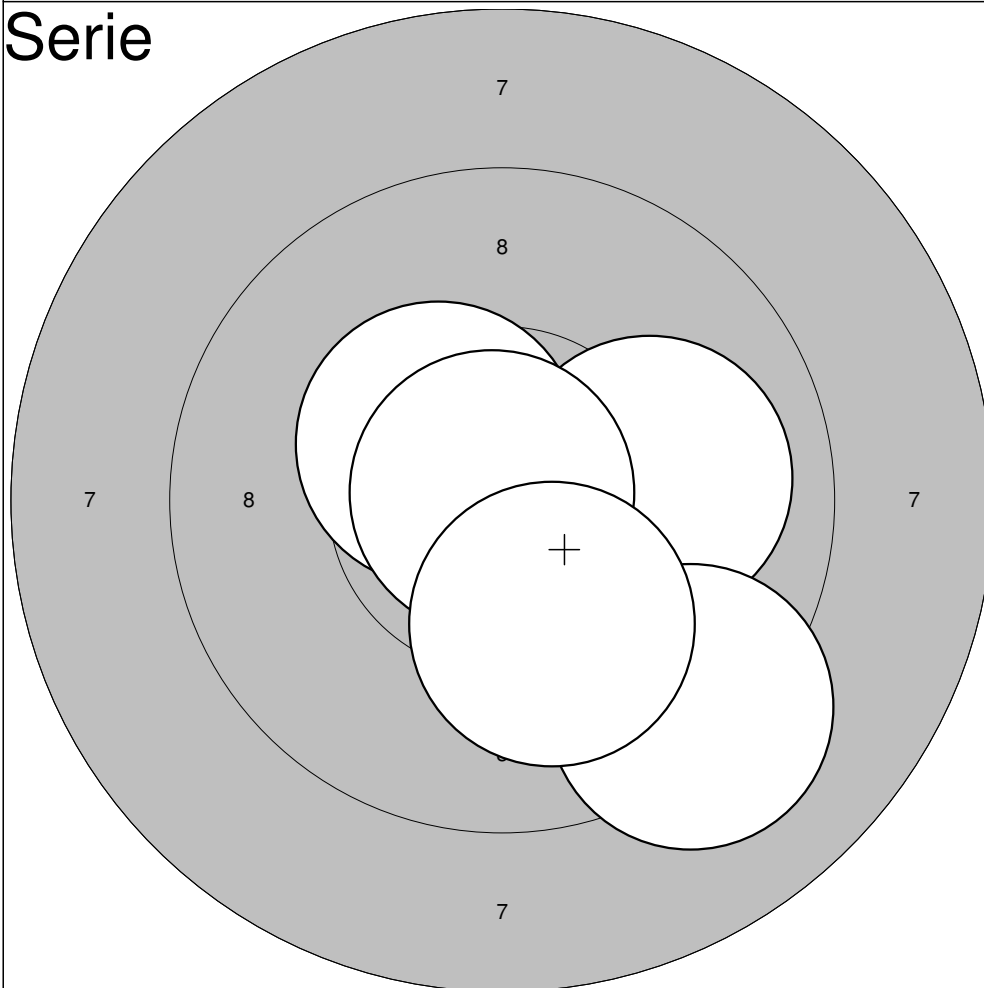
**Serie**

6:10,0 →

7:10,4\* ↗

8: 9,2 ↘

9:10,9\* ↗

10:10,1 ↓

Serie: 50,6

Summa: 522,6

**Serie**

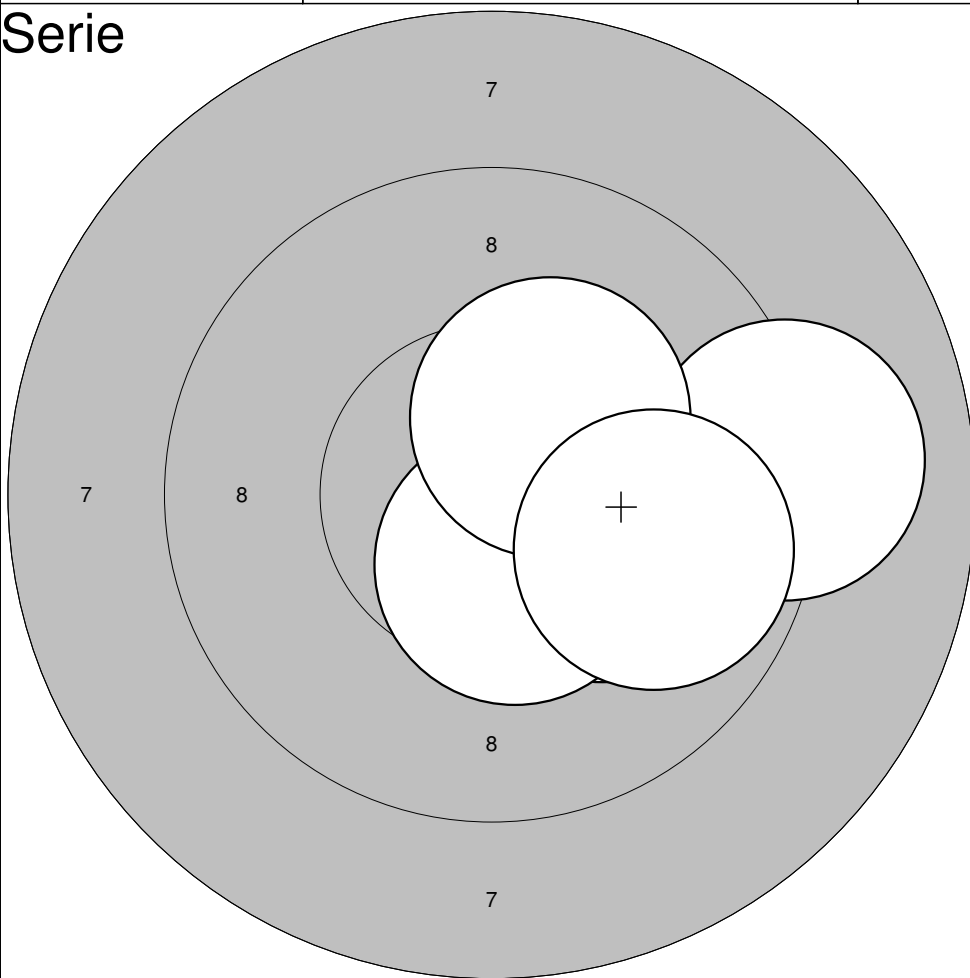

- 1: 9,1 →
- 2: 10,2\* ↘
- 3: 10,5\* ↓
- 4: 10,3\* ↗
- 5: 9,9 ↘

**Serie: 50,0**

**Summa: 467,6**

**Serie**

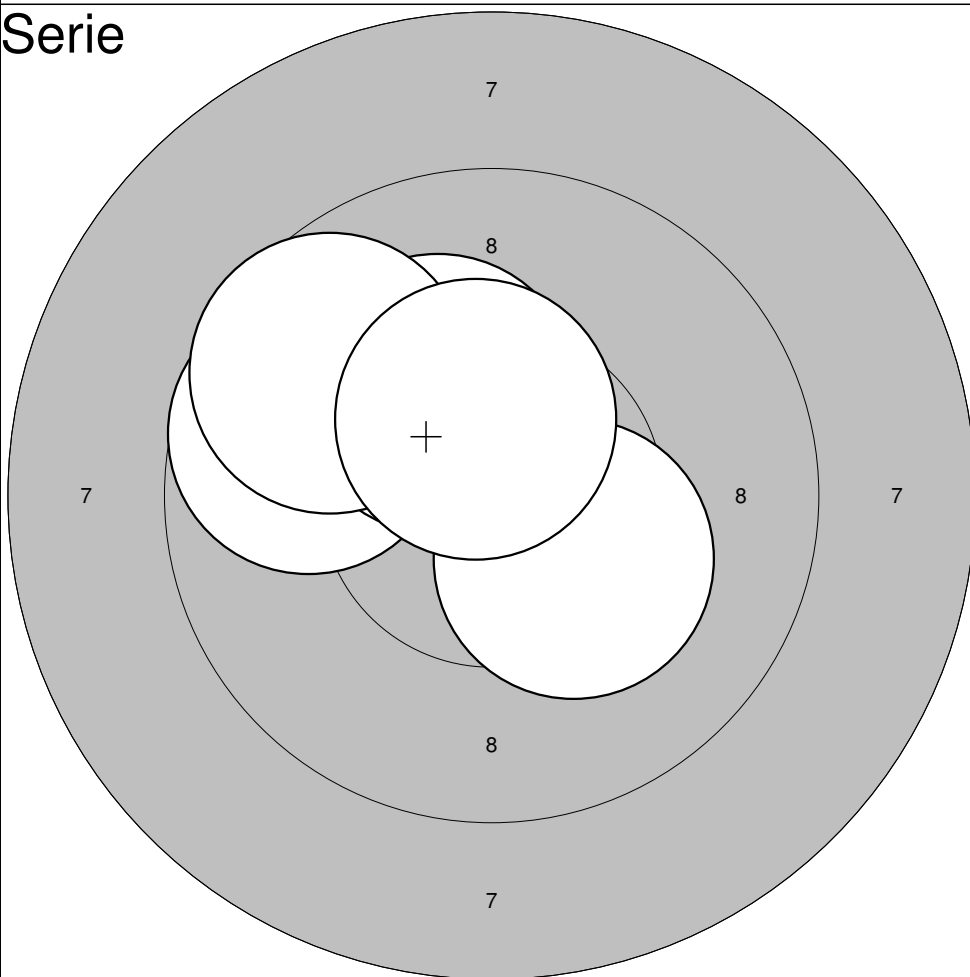

- 6: 9,7 ←
- 7: 10,3\* ↘
- 8: 10,2\* ↗
- 9: 9,7 ↗
- 10: 10,5\* ↑

**Serie: 50,4**

**Summa: 518,0**

**Serie**

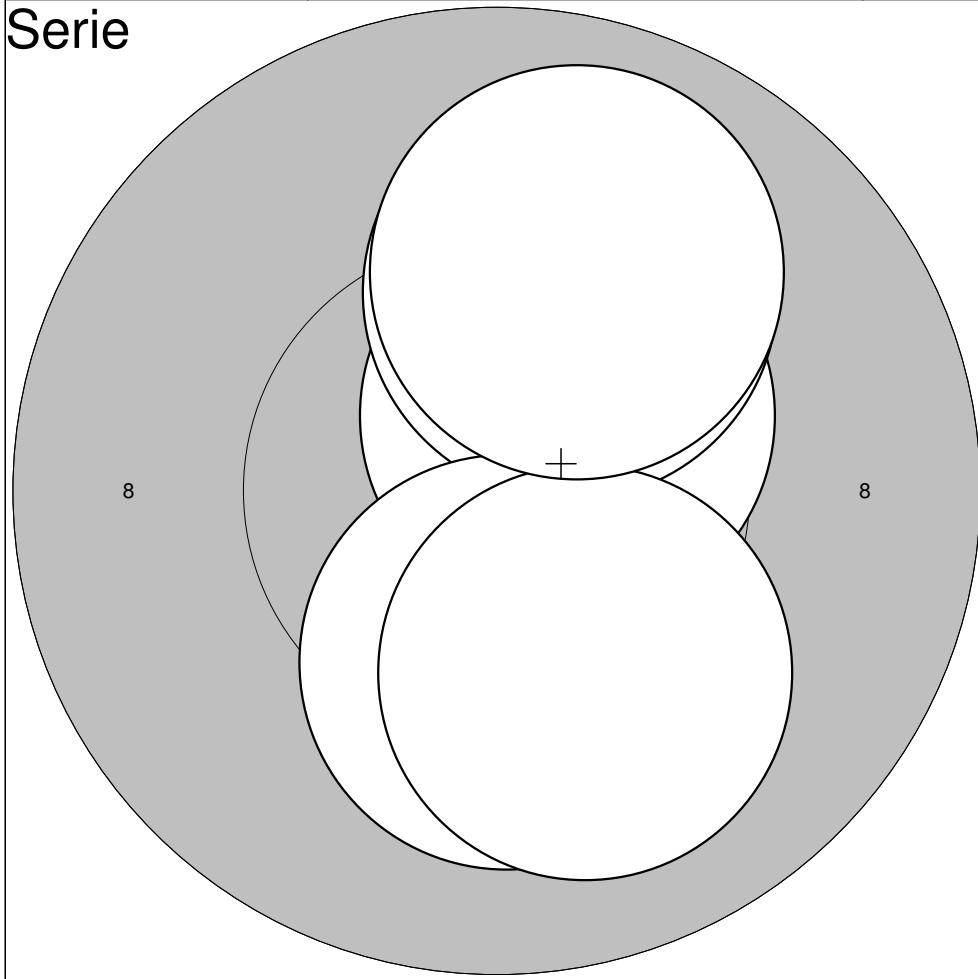

1: 10,5*	↗
2: 10,0	↗
3: 10,2*	↓
4: 10,1	↘
5: 9,9	↗

**Serie: 50,7**

**Summa: 467,1**

**Serie**

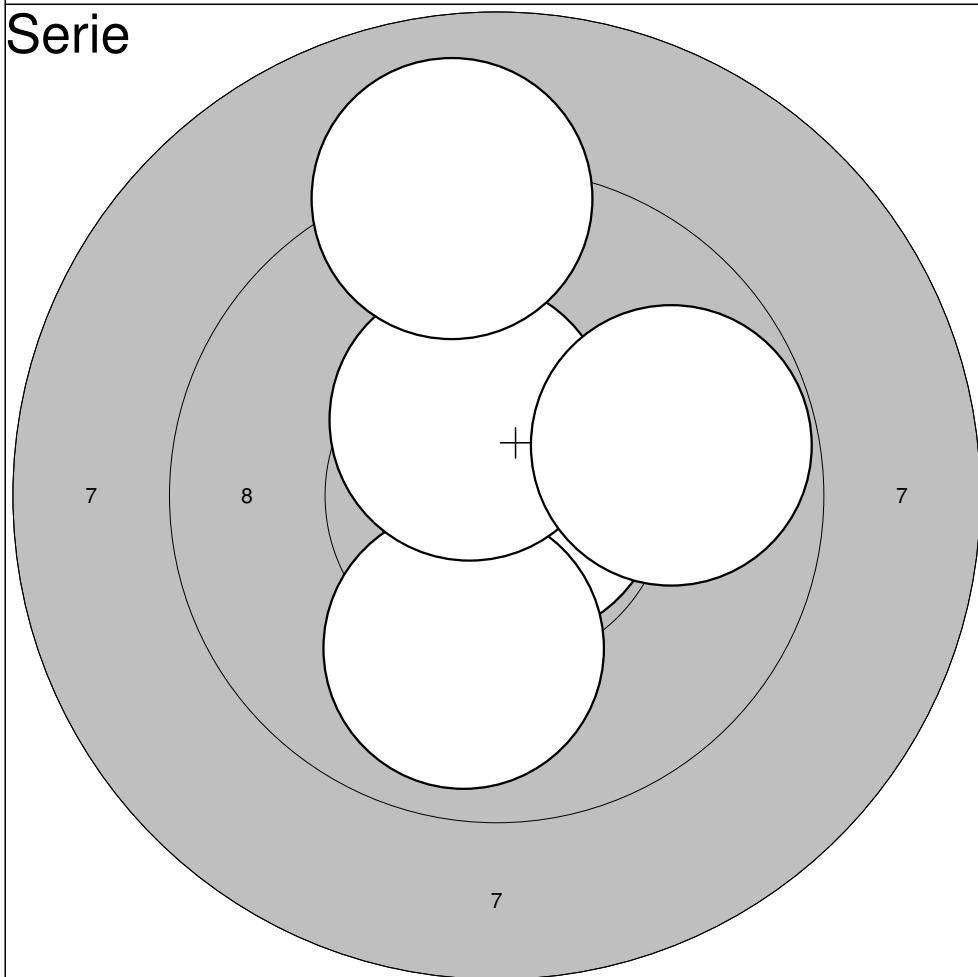

6: 10,8*	→
7: 9,9	↓
8: 10,4*	↗
9: 9,8	→
10: 9,0	↗

**Serie: 49,9**

**Summa: 517,0**

**Serie**

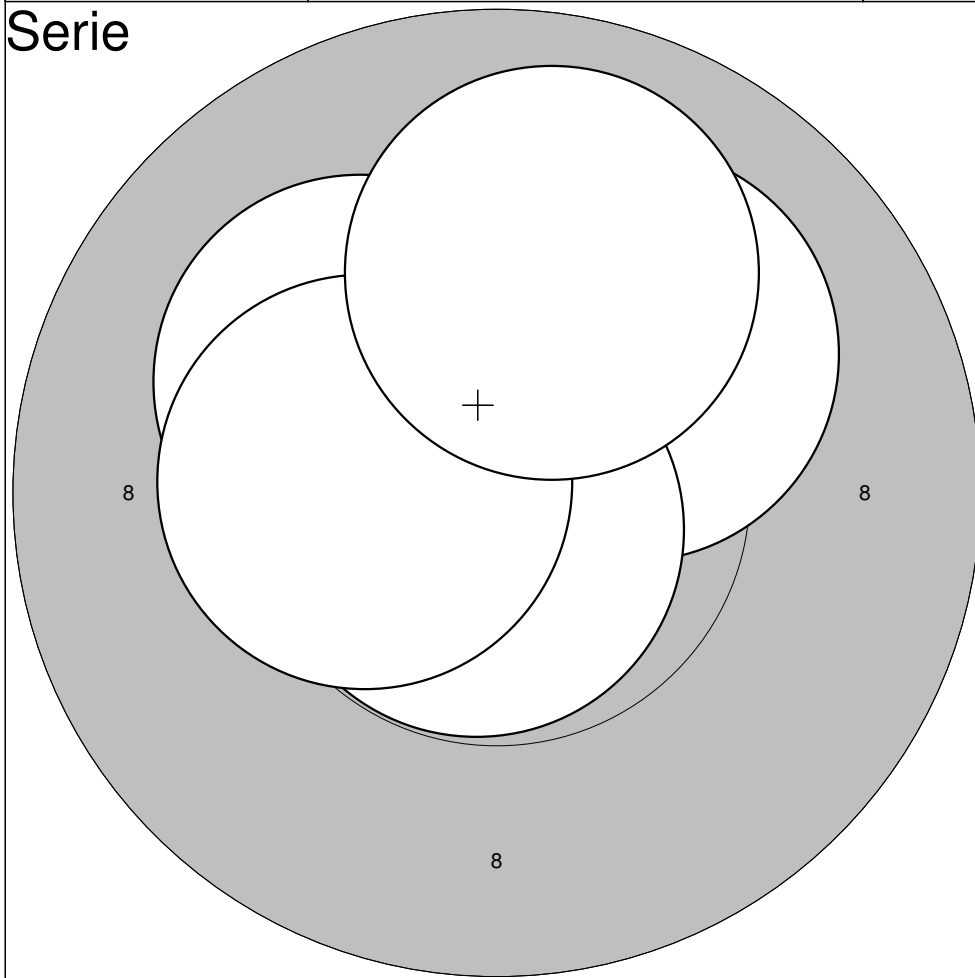

- 1:10,1 ↗
- 2:10,8\* ↘
- 3:10,2\* ↗
- 4:10,4\* ←
- 5:10,0 ↑

**Serie: 51,5**

**Summa: 467,0**

**Serie**

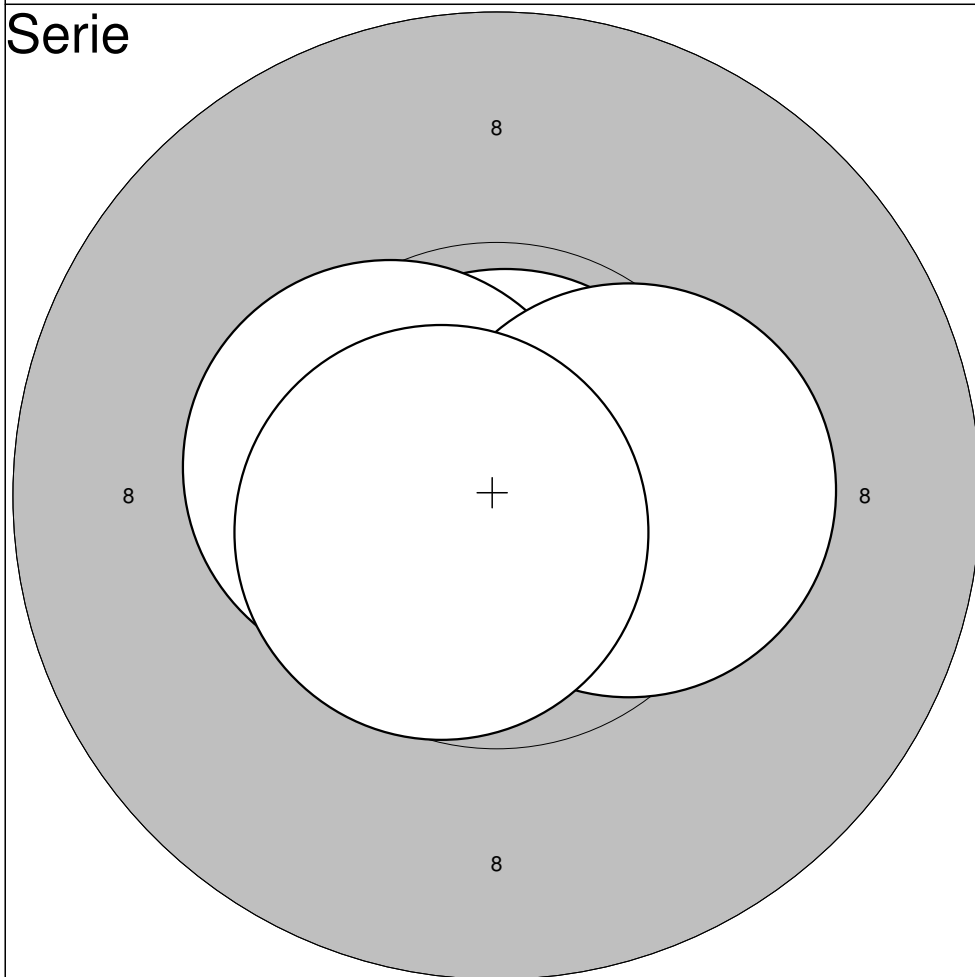

- 6:10,9\* ↗
- 7:10,5\* ←
- 8:10,4\* →
- 9:10,7\* ↘

**Serie: 42,5**

**Summa: 509,5**

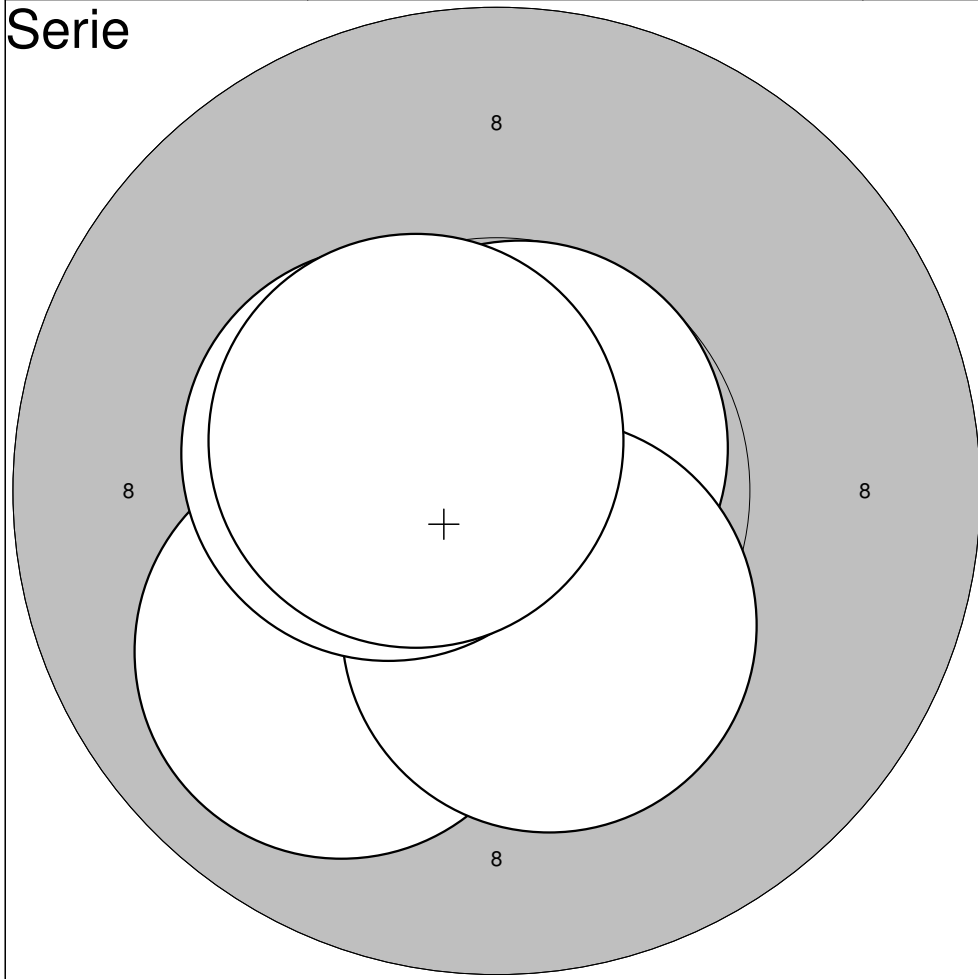

1:10,7*	↗
2:10,0	↙
3:10,3*	↓
4:10,5*	↖
5:10,5*	↖

<b>Serie:</b>	<b>52,0</b>
---------------	-------------

<b>Summa:</b>	<b>467,3</b>
---------------	--------------

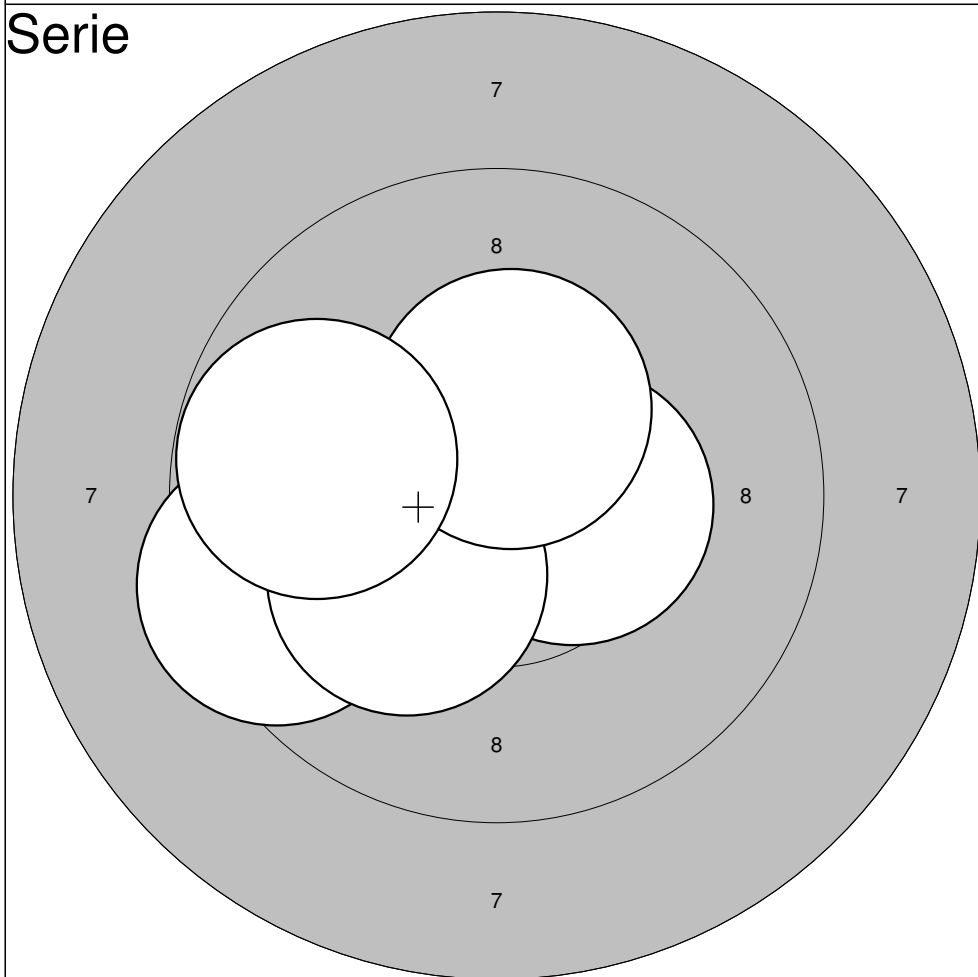

6:10,5*	→
7: 9,4	↙
8:10,2*	↙
9:10,4*	↑
10: 9,8	↖

<b>Serie:</b>	<b>50,3</b>
---------------	-------------

<b>Summa:</b>	<b>517,6</b>
---------------	--------------

**Serie**

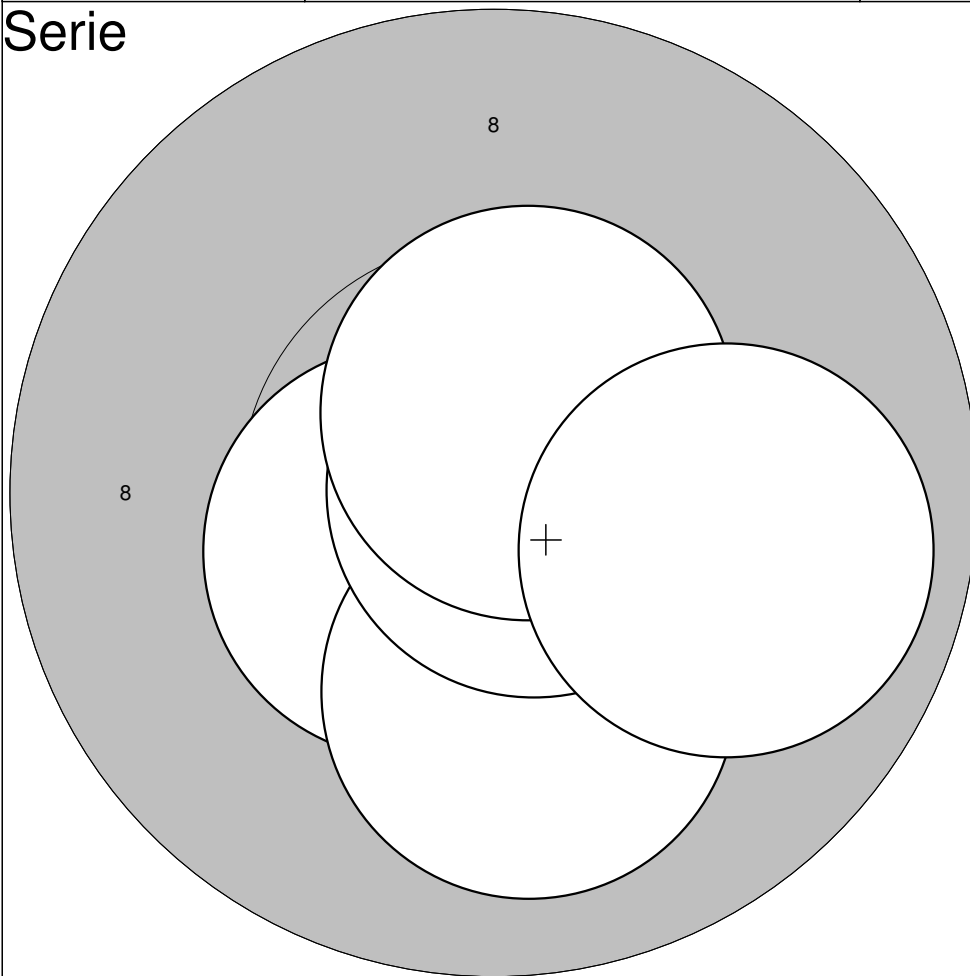

- 1: 10,5\* ↙
- 2: 10,1 ↓
- 3: 10,8\* →
- 4: 10,6\* ↗
- 5: 9,9 ➔

**Serie: 51,9**

**Summa: 467,0**

**Serie**

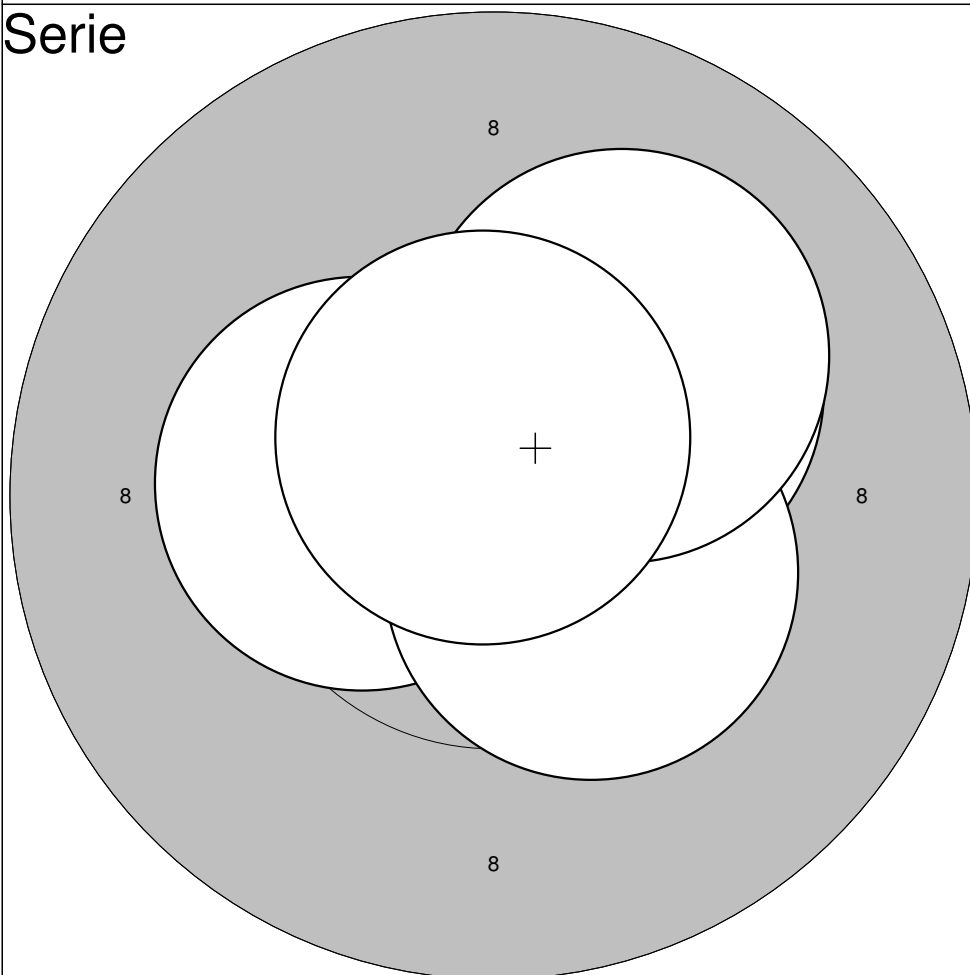

- 6: 10,2\* ↗
- 7: 10,4\* ↖
- 8: 10,4\* ↘
- 9: 10,1 ↗
- 10: 10,7\* ↗

**Serie: 51,8**

**Summa: 518,8**

**Serie**

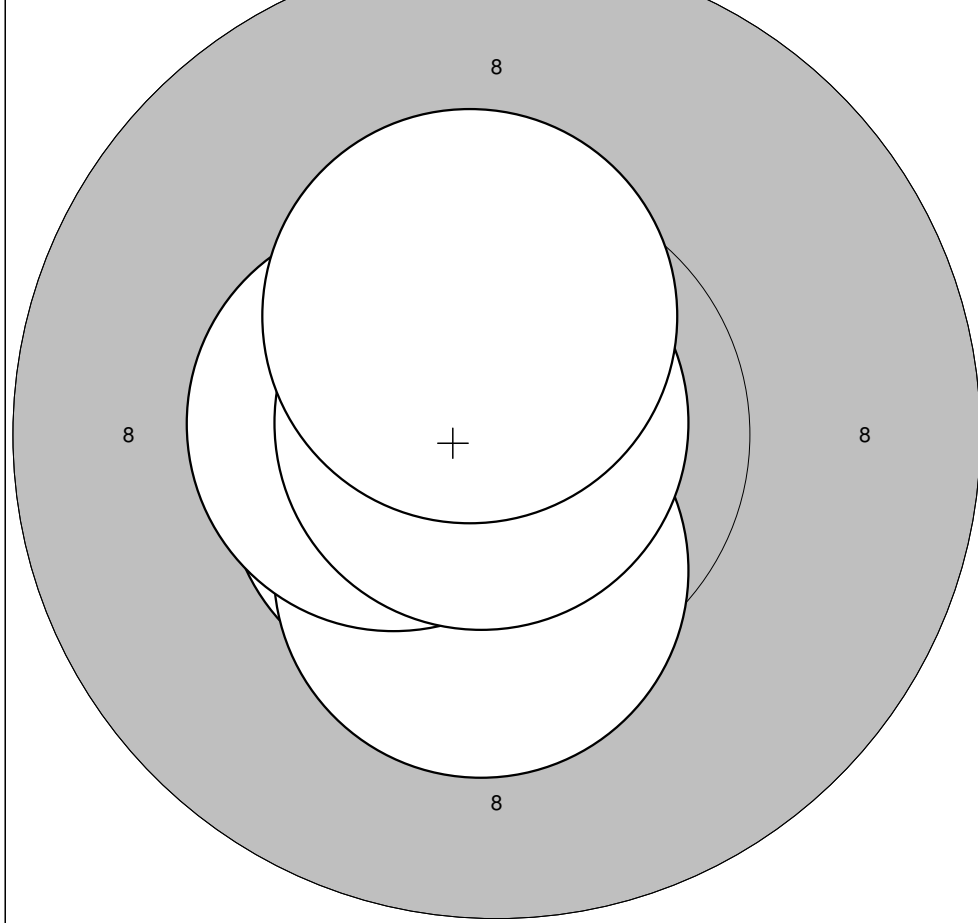

1:10,6*	↙
2:10,4*	↓
3:10,5*	←
4:10,9*	↗
5:10,4*	↑

**Serie: 52,8**

**Summa: 467,7**

**Serie**

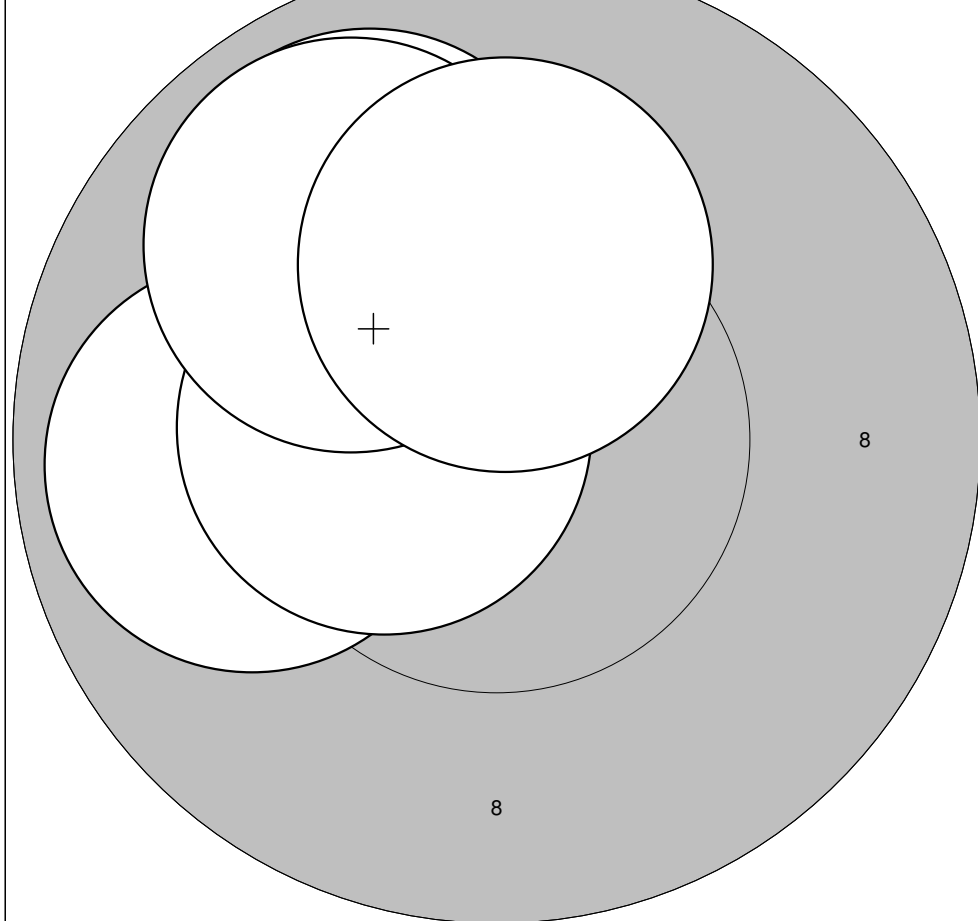

6: 9,9	←
7: 9,9	↗
8:10,5*	←
9: 9,9	↗
10:10,2*	↑

**Serie: 50,4**

**Summa: 518,1**



**Serie**

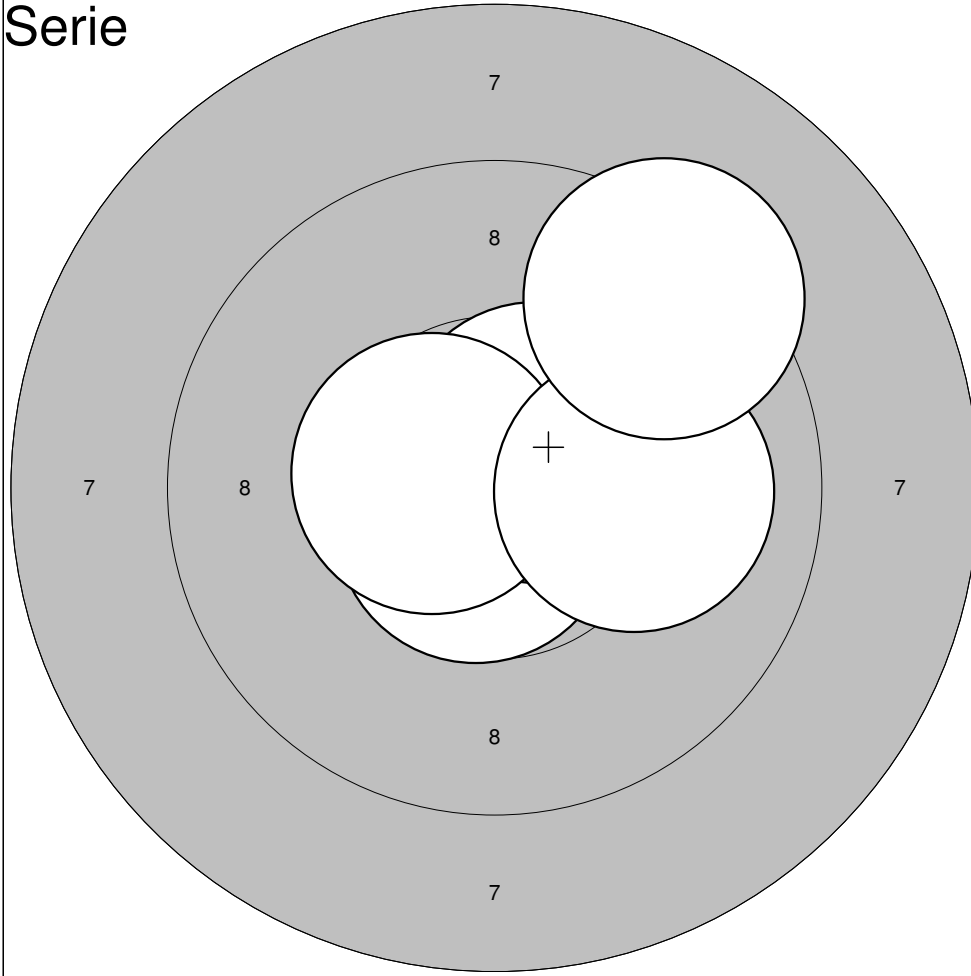

1: 10,7*	↙
2: 10,6*	↗
3: 10,5*	↖
4: 10,1	→
5: 9,3	↗

**Serie: 51,2**

**Summa: 465,5**

**Serie**

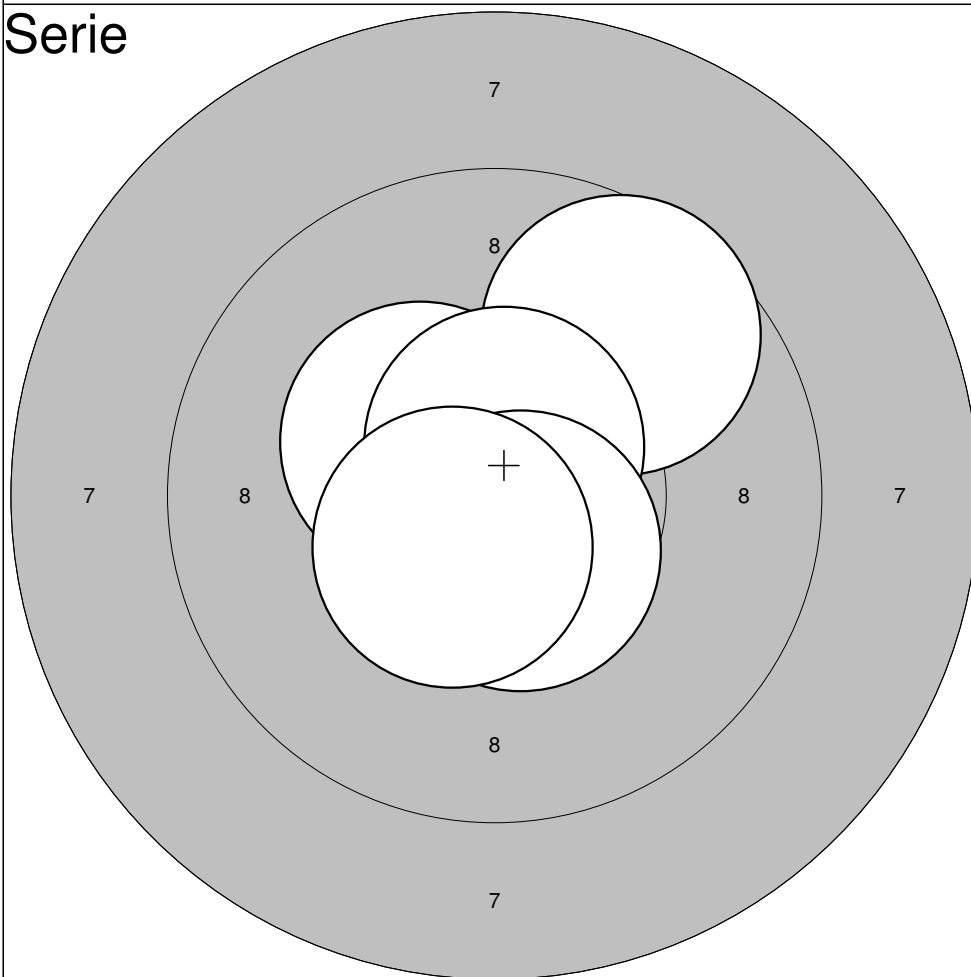

6: 9,6	↗
7: 10,4*	↖
8: 10,6*	↑
9: 10,6*	↘
10: 10,5*	↙

**Serie: 51,7**

**Summa: 517,2**

**Serie**

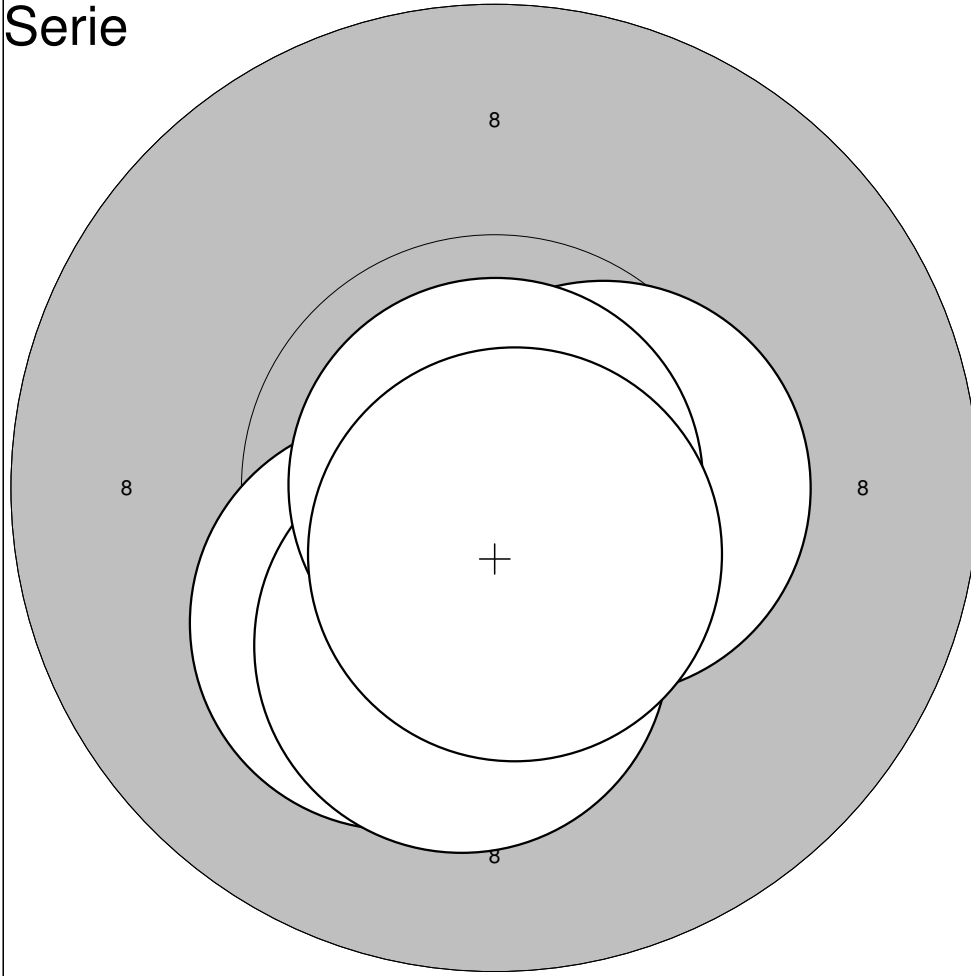

- 1: 10,5\* →
- 2: 10,2\* ↙
- 3: 10,2\* ↓
- 4: 10,9\* ↗
- 5: 10,6\* ↓

**Serie: 52,4**

**Summa: 466,6**

**Serie**

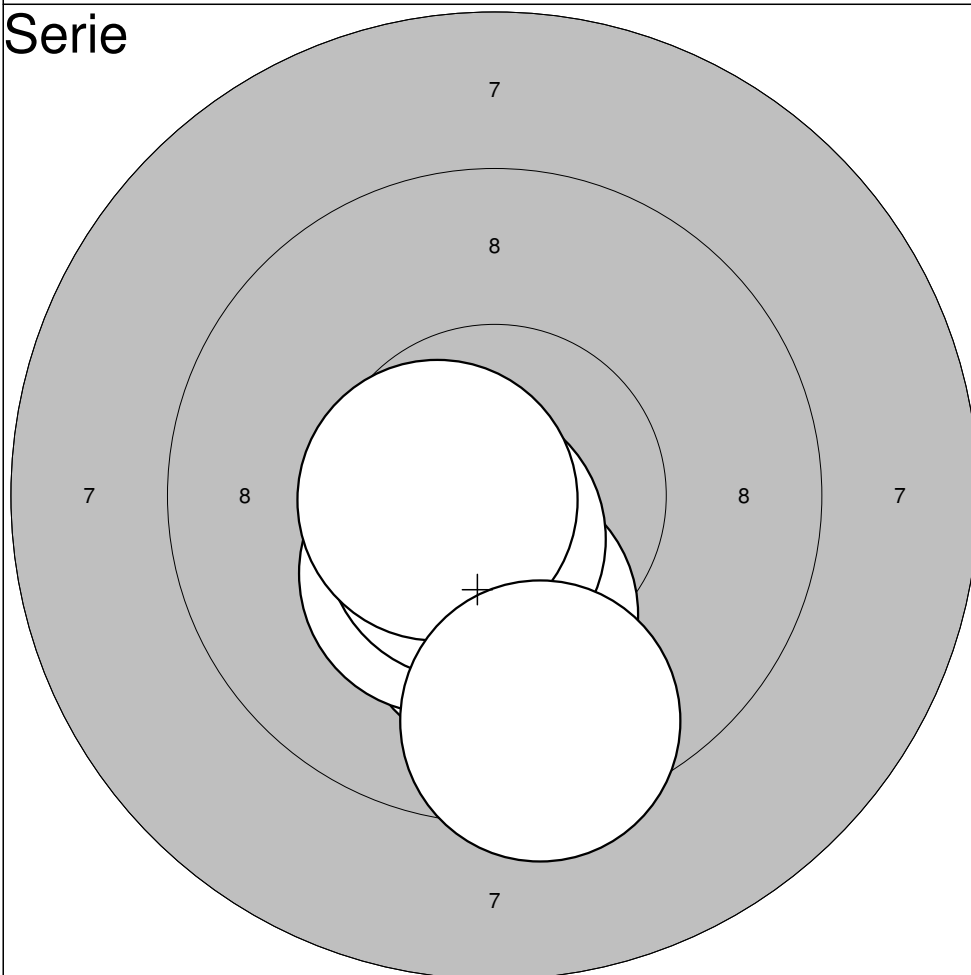

- 6: 10,2\* ↓
- 7: 10,3\* ↙
- 8: 10,6\* ↙
- 9: 10,6\* ←
- 10: 9,5 ↓

**Serie: 51,2**

**Summa: 517,8**

**Serie**

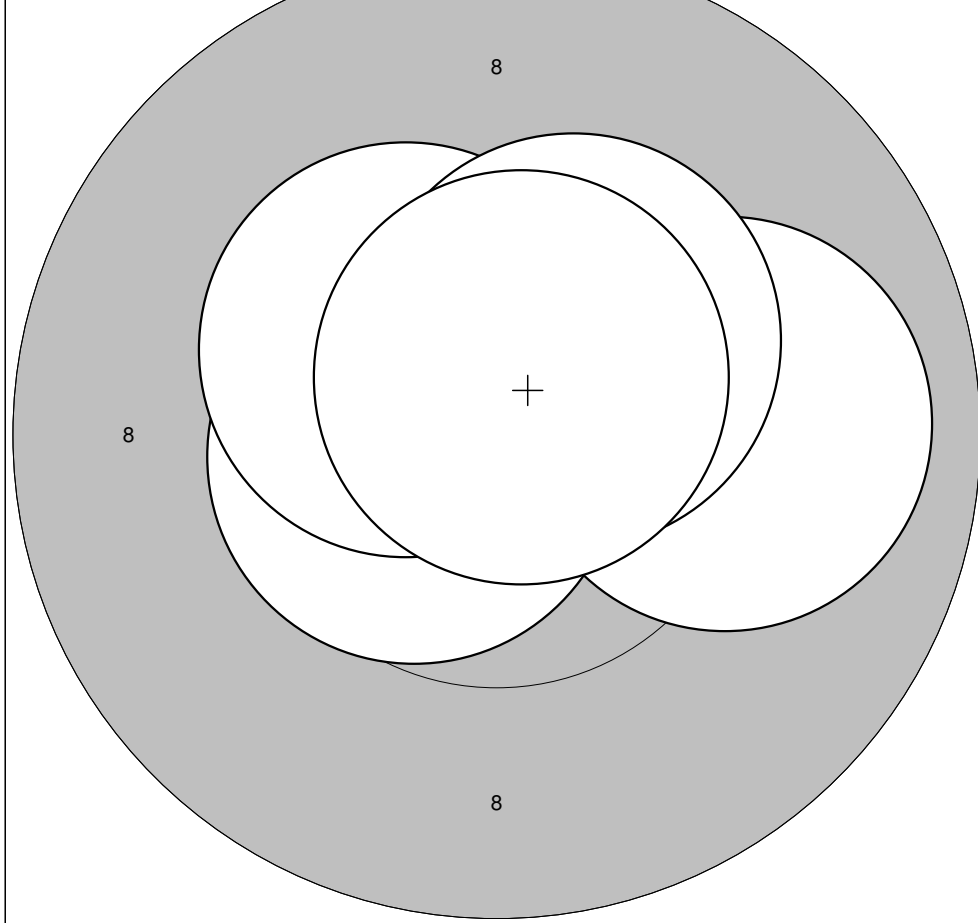

1:10,6*	←
2:10,4*	↗
3:10,0	→
4:10,4*	↗
5:10,7*	↗

<b>Serie:</b>	<b>52,1</b>
<b>Summa:</b>	<b>466,1</b>

**Serie**

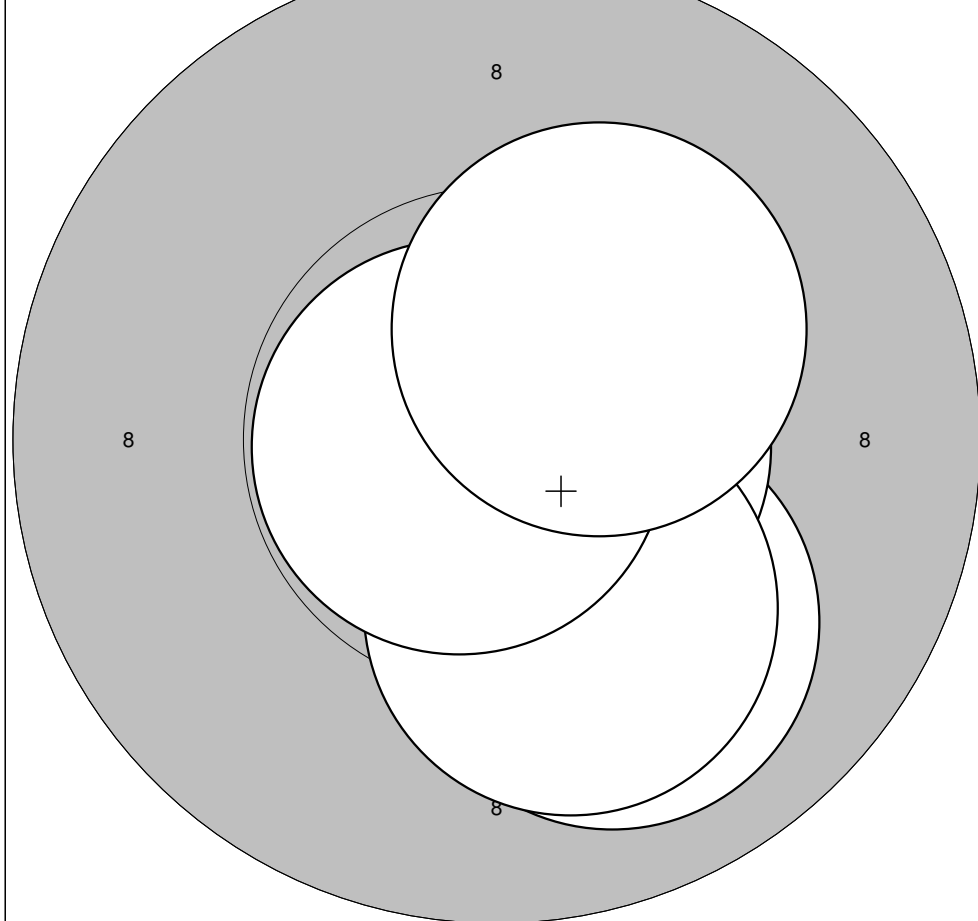

6:10,0	↓
7:10,7*	→
8:10,1	↓
9:10,8*	←
10:10,3*	↗

<b>Serie:</b>	<b>51,9</b>
<b>Summa:</b>	<b>518,0</b>

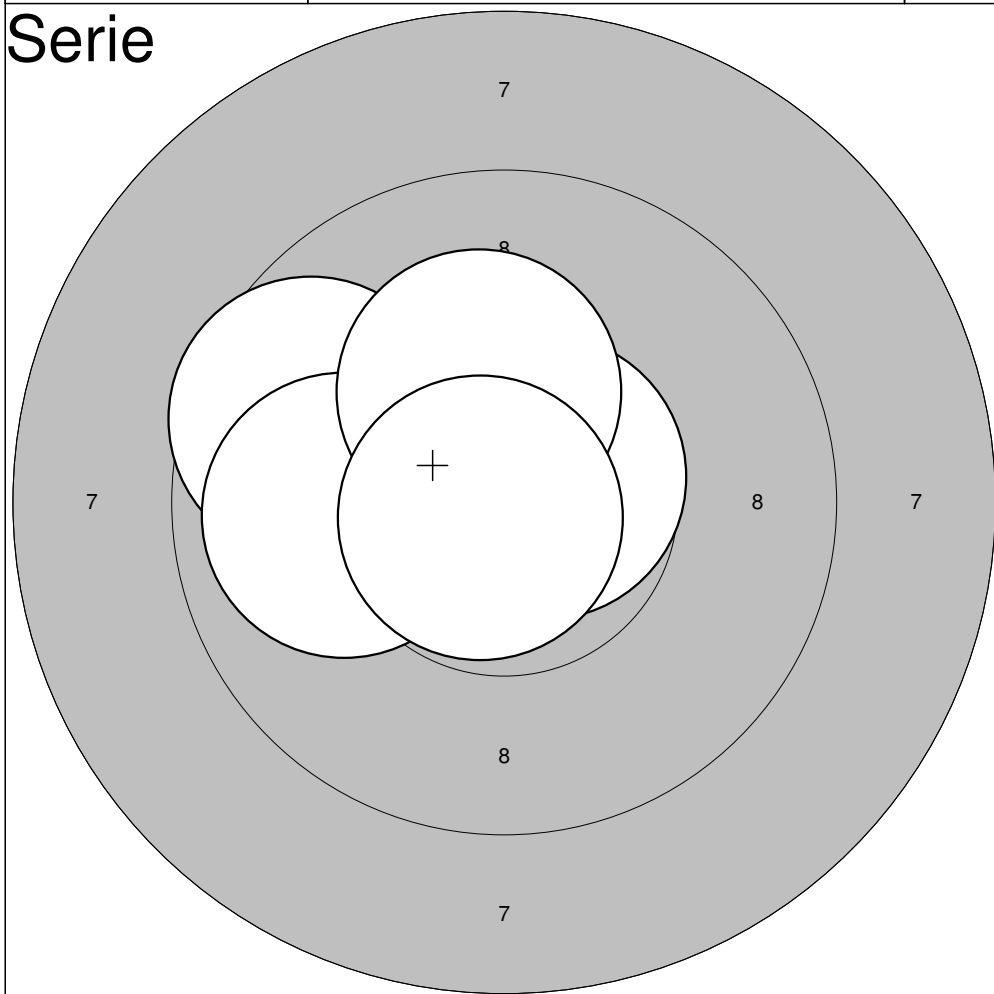

1: 9,6	↖
2: 10,7*	↗
3: 9,9	↖
4: 10,2*	↗
5: 10,8*	↖

**Serie: 51,2**

**Summa: 449,2**

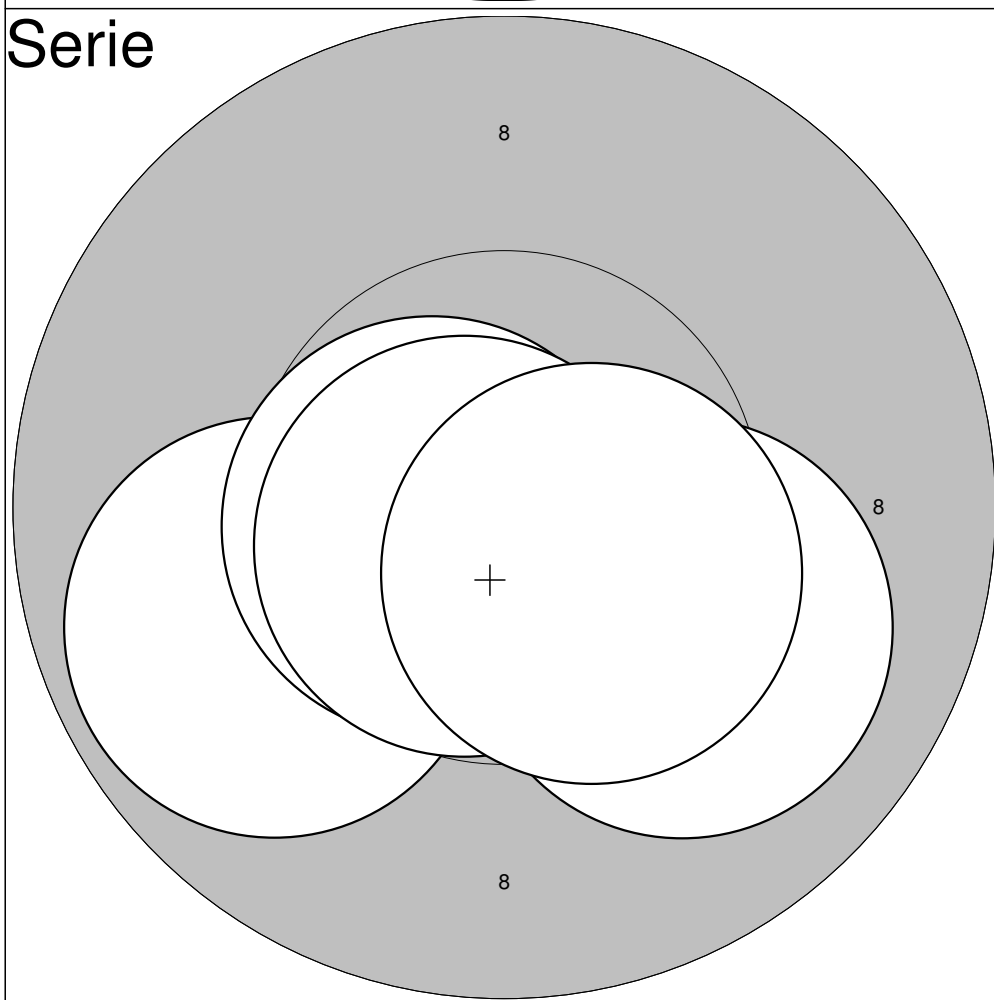

6: 10,0	↘
7: 9,8	↖
8: 10,6*	↖
9: 10,7*	↘
10: 10,5*	↘

**Serie: 51,6**

**Summa: 500,8**

**Serie**

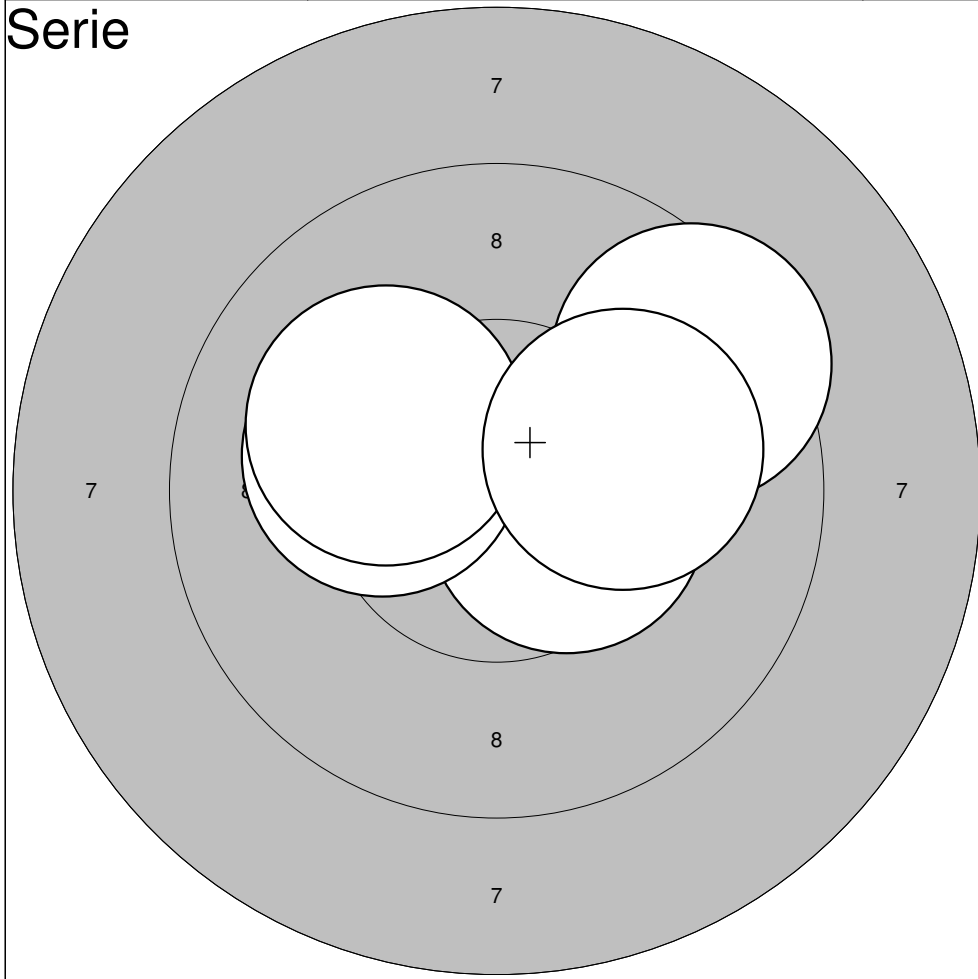

1: 10,5*	➔
2: 10,2*	➤
3: 9,5	➤
4: 10,1	➤
5: 10,1	➔

Serie:	50,4
Summa:	445,4

**Serie**

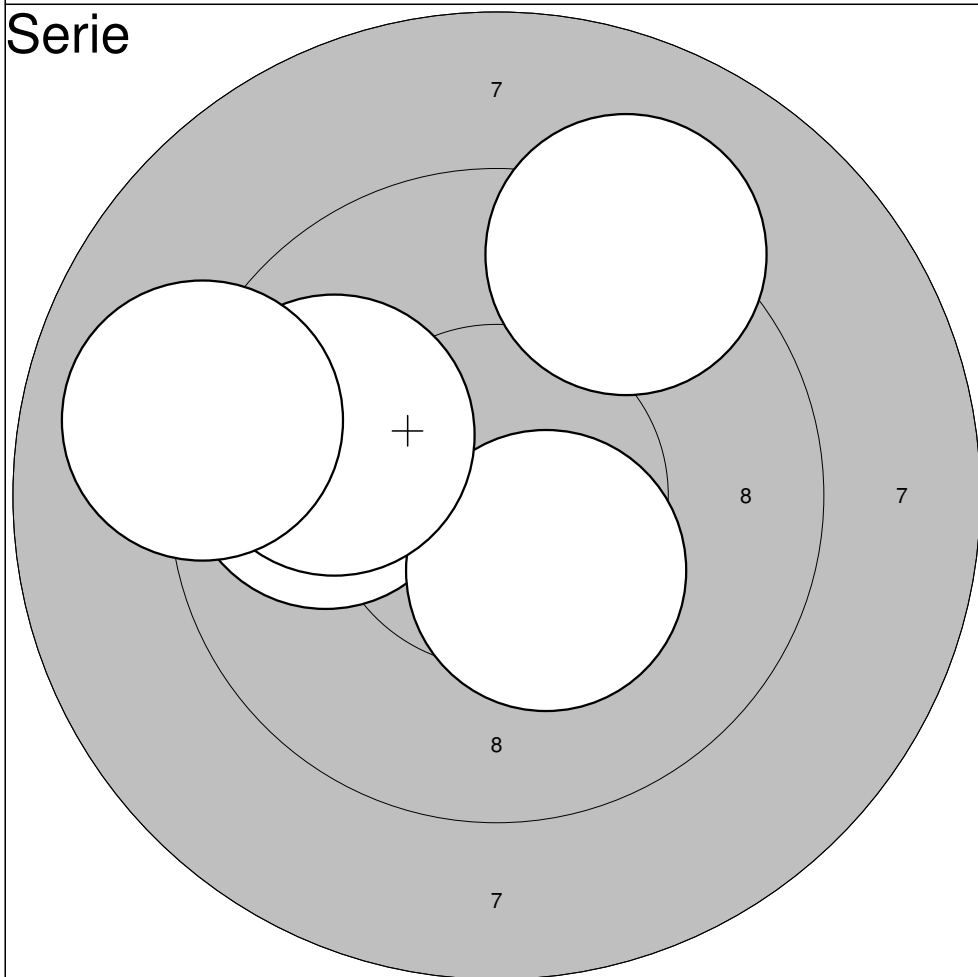

6: 9,2	➤
7: 9,8	➤
8: 10,4*	➤
9: 9,8	➤
10: 9,0	➤

Serie:	48,2
Summa:	493,6

**Serie**

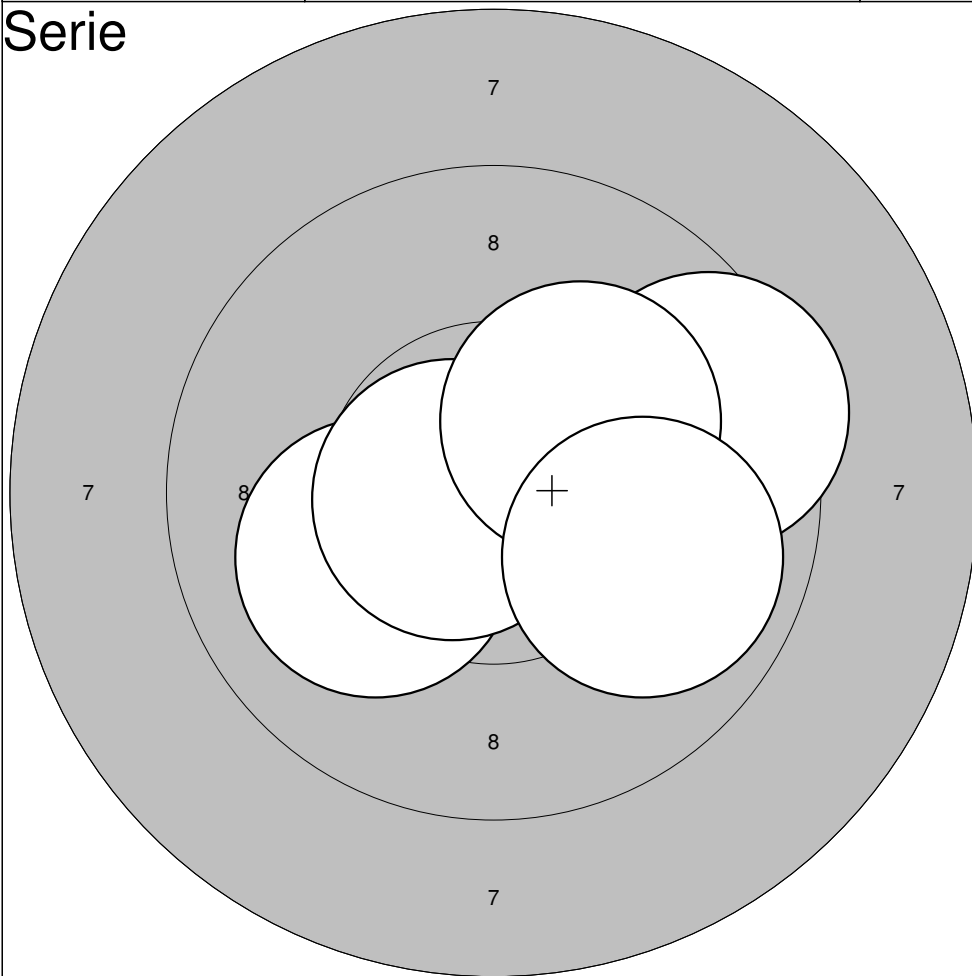

- 1: 10,1 ↙
- 2: 9,5 →
- 3: 10,7\* ↙
- 4: 10,2\* ↗
- 5: 9,9 ↘

**Serie: 50,4**

**Summa: 443,4**

**Serie**

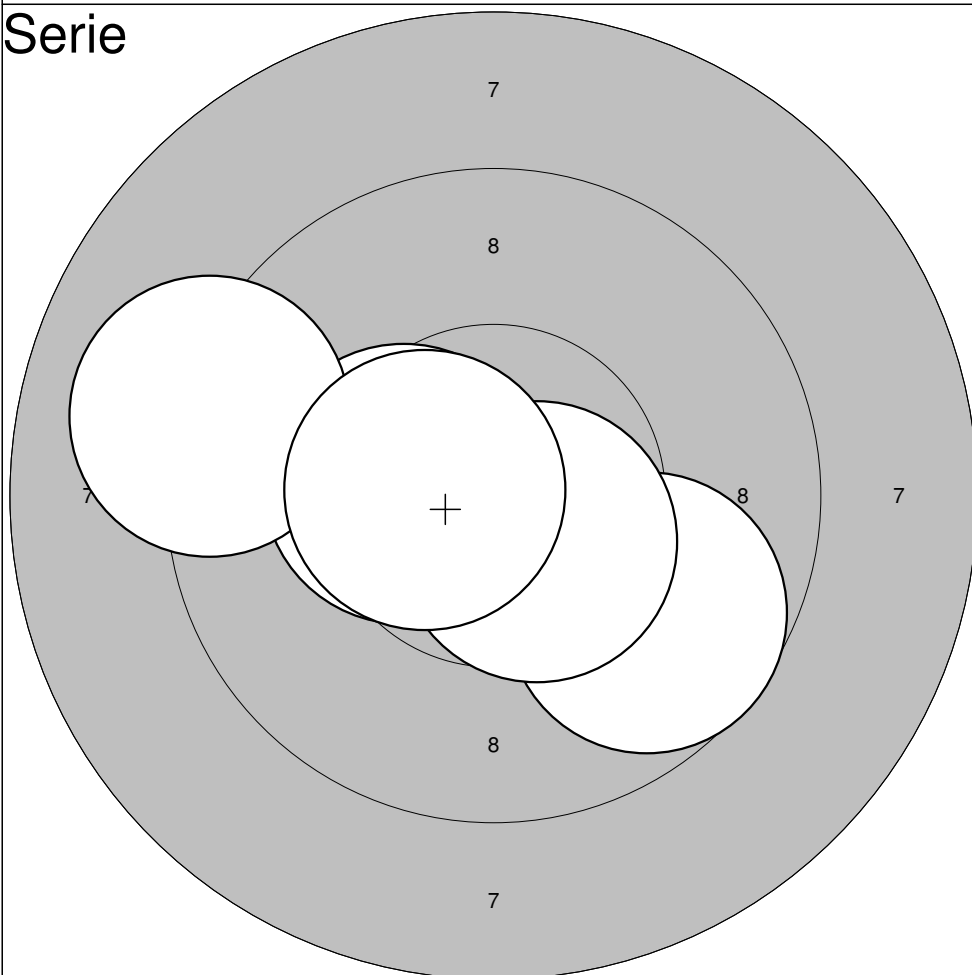

- 6: 10,4\* ↙
- 7: 9,7 ↘
- 8: 9,1 ↙
- 9: 10,5\* ↘
- 10: 10,5\* ↙

**Serie: 50,2**

**Summa: 493,6**

**Serie**

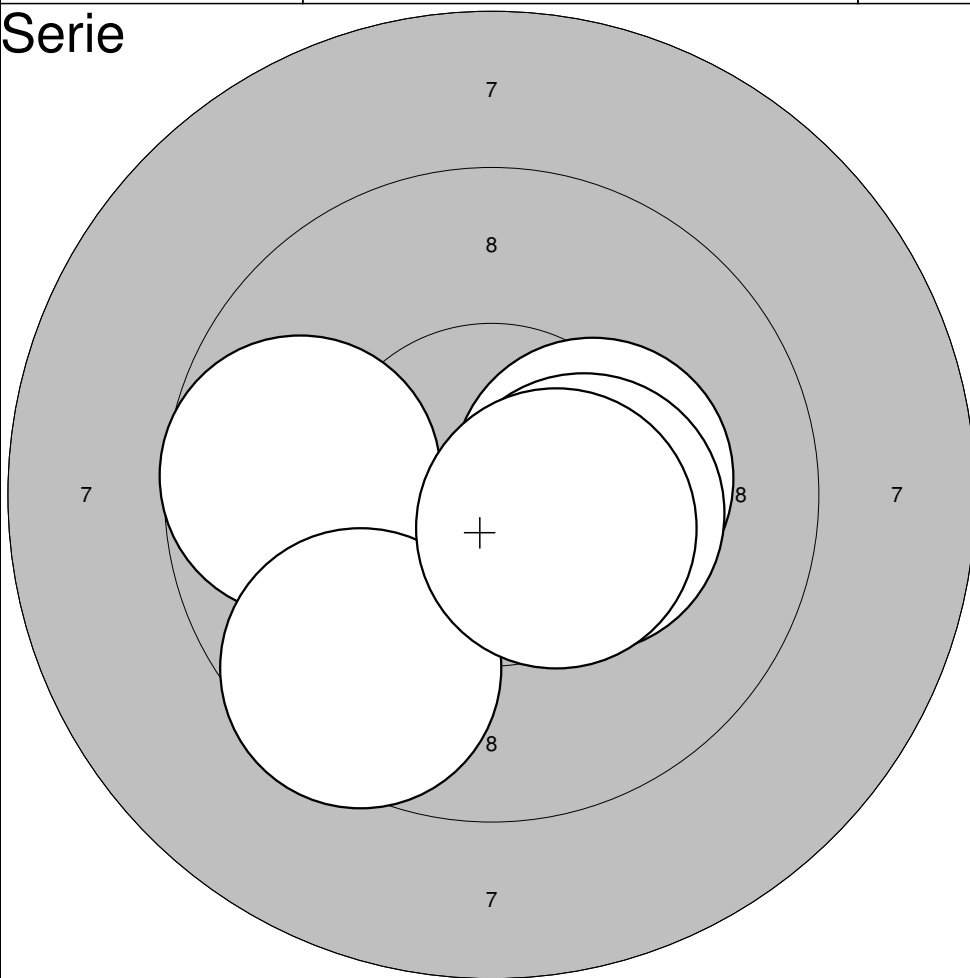

- 1: 10,3\* →
- 2: 10,3\* →
- 3: 9,7 ←
- 4: 9,6 ↙
- 5: 10,5\* ↘

**Serie: 50,4**

**Summa: 443,4**

**Serie**

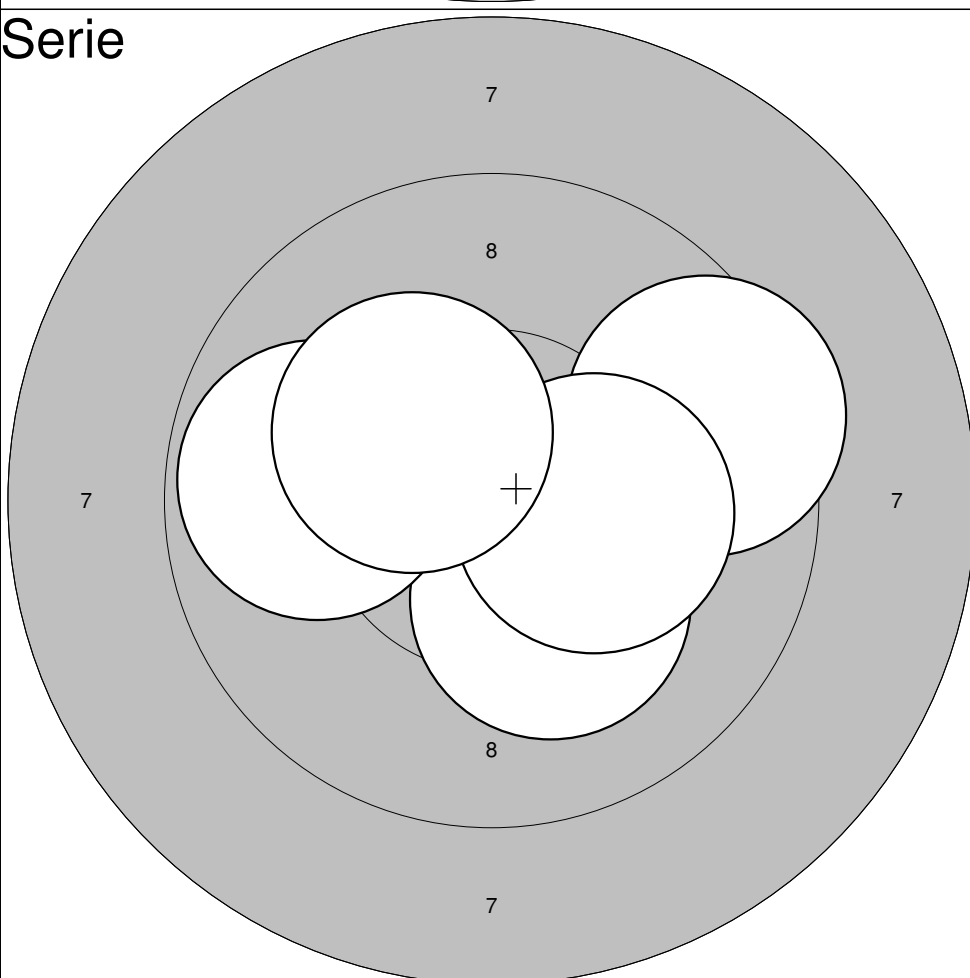

- 6: 10,2\* ↘
- 7: 9,5 →
- 8: 9,8 ←
- 9: 10,3\* →
- 10: 10,3\* ↗

**Serie: 50,1**

**Summa: 493,5**

### Serie

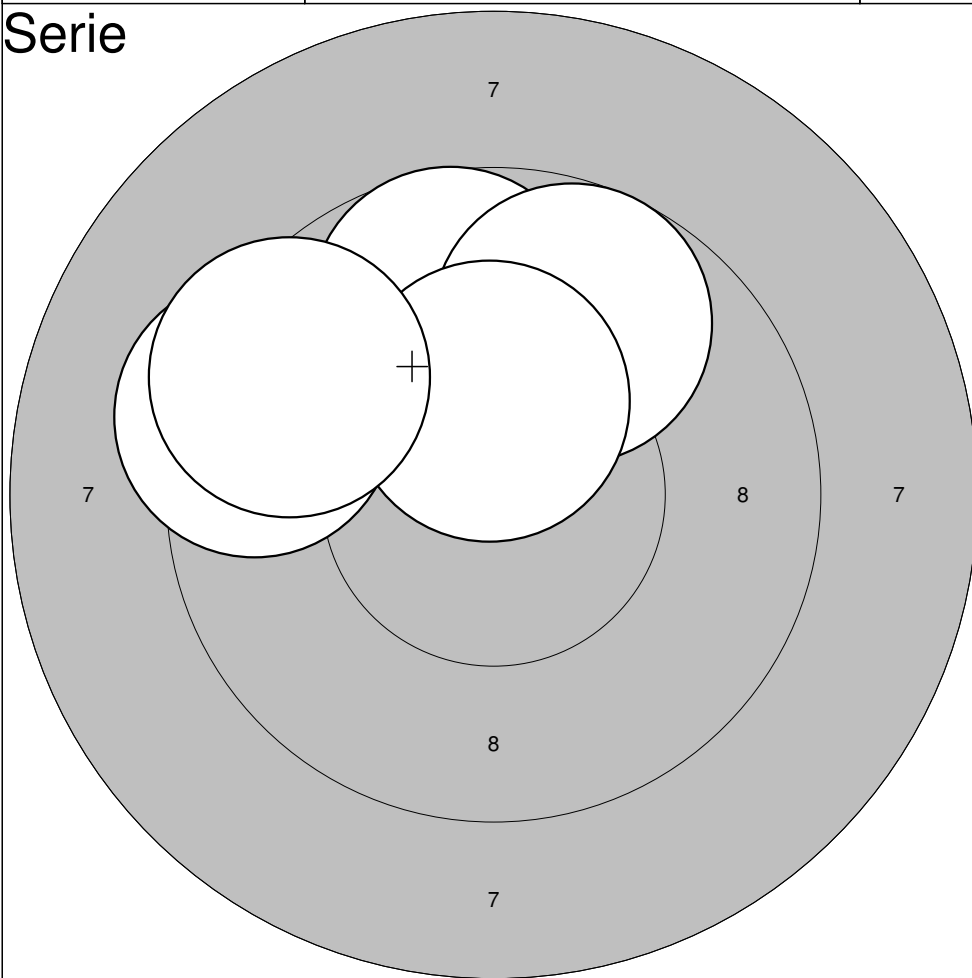

- 1: 9,3 ↙
- 2: 9,7 ↑
- 3: 9,7 ↗
- 4: 10,4\* ↑
- 5: 9,4 ↙

Serie: 48,5

Summa: 440,5

### Serie

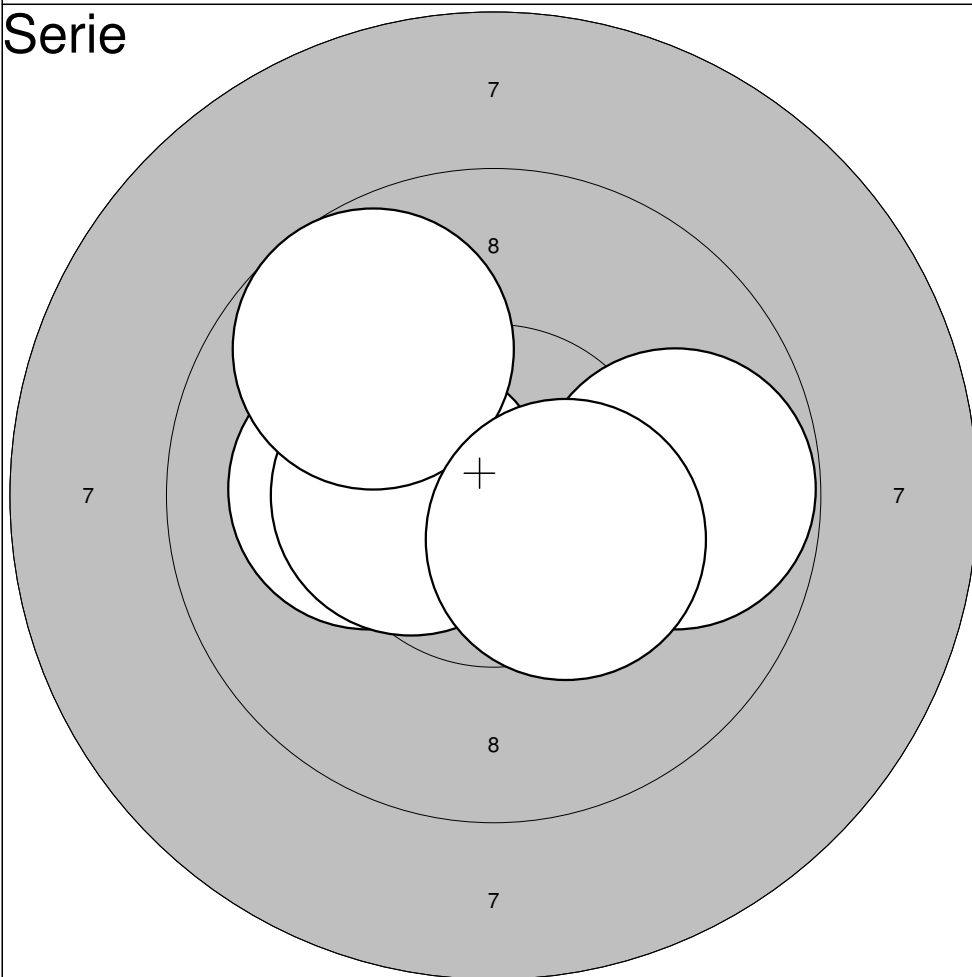

- 6: 9,8 →
- 7: 10,2\* ↙
- 8: 10,4\* ↙
- 9: 9,7 ↗
- 10: 10,4\* ↘

Serie: 50,5

Summa: 491,0



### Serie

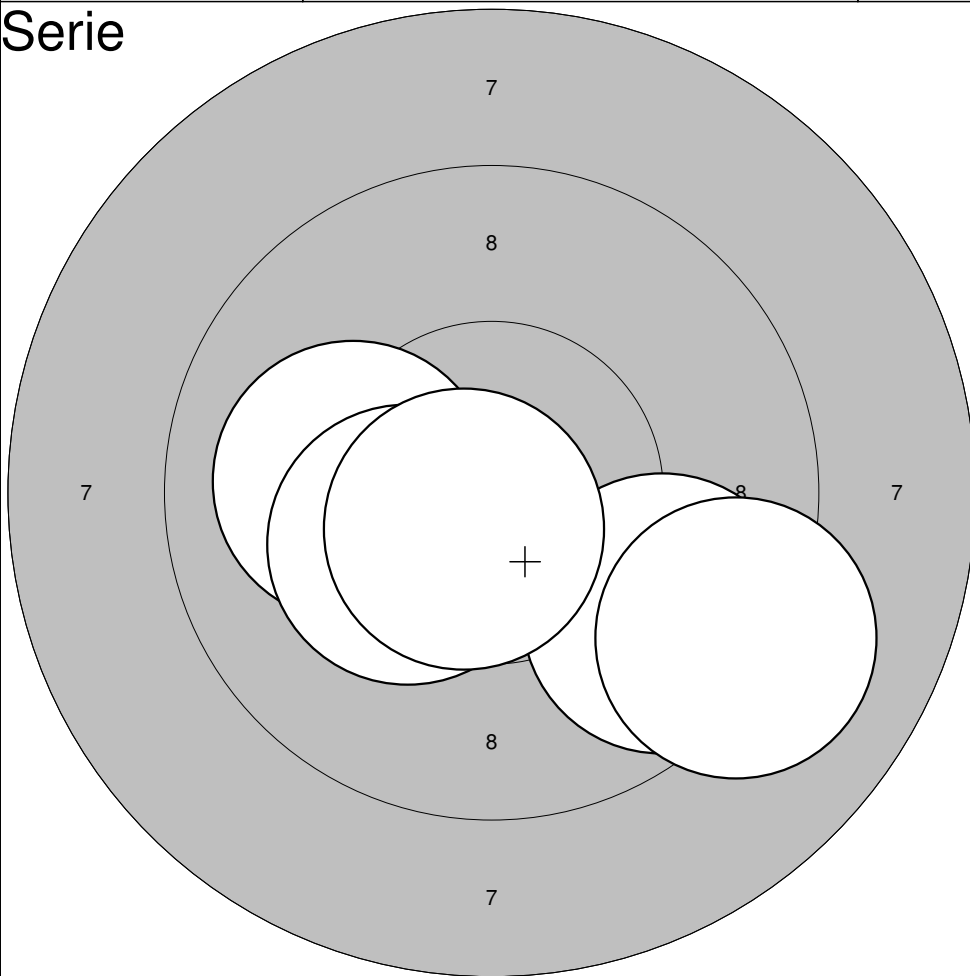

- 1: 10,1 ←
- 2: 9,6 ↘
- 3: 9,1 ↘
- 4: 10,3\* ←
- 5: 10,7\* ↘

Serie: 49,8

Summa: 440,8

### Serie

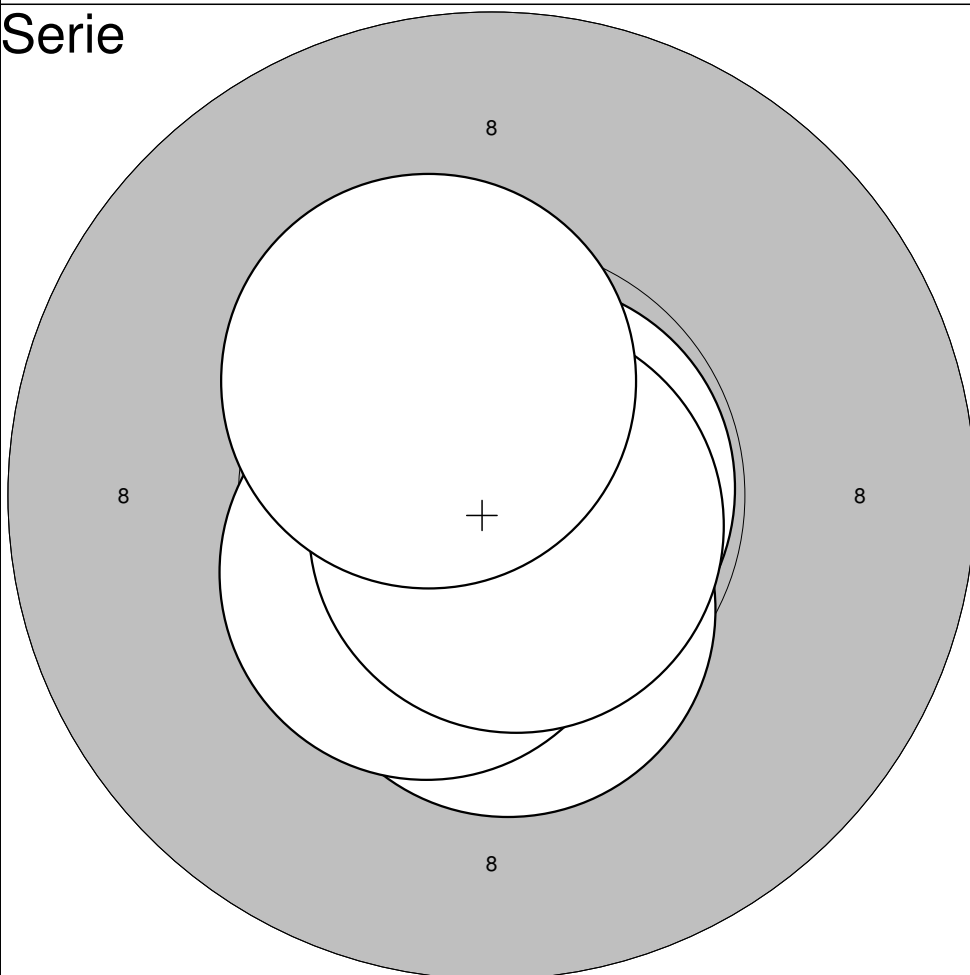

- 6: 10,4\* ↓
- 7: 10,5\* ↘
- 8: 10,8\* →
- 9: 10,8\* ↘
- 10: 10,4\* ↗

Serie: 52,9

Summa: 493,7

**Serie**

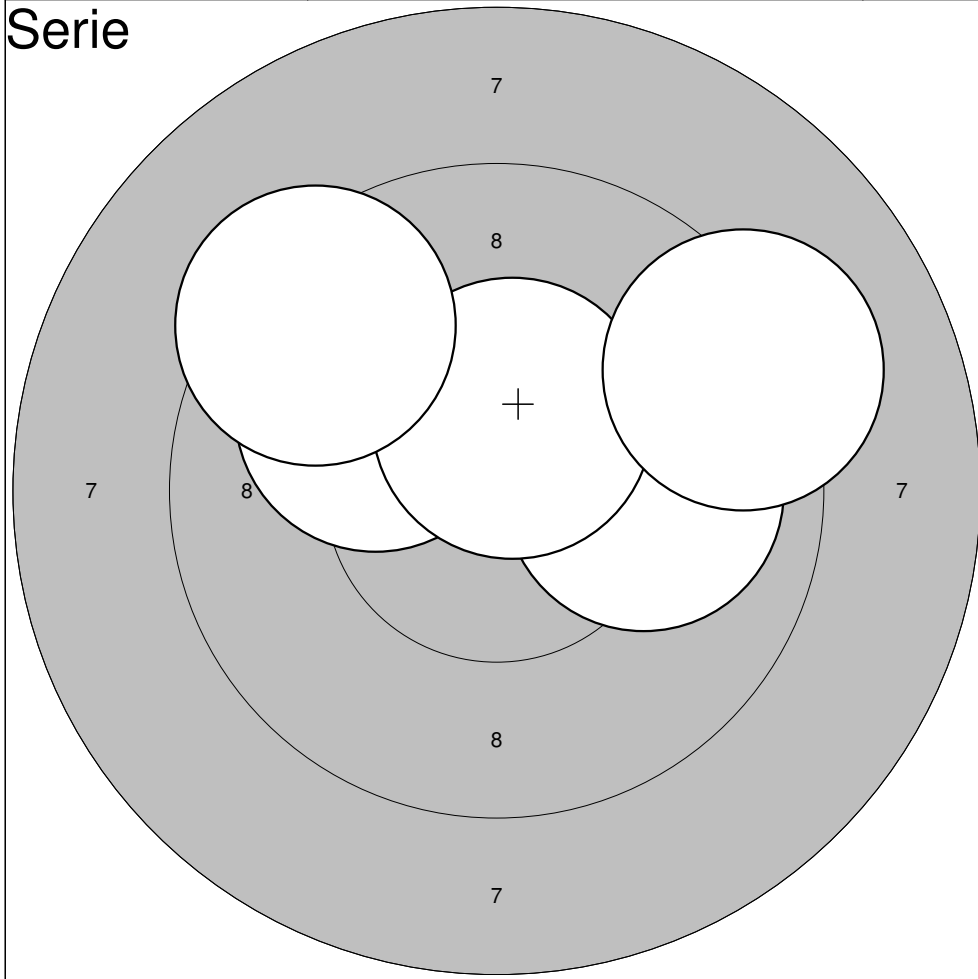

1: 10,0	→
2: 10,0	↖
3: 10,5*	↑
4: 9,4	↖
5: 9,2	↗

**Serie: 49,1**

**Summa: 439,1**

**Serie**

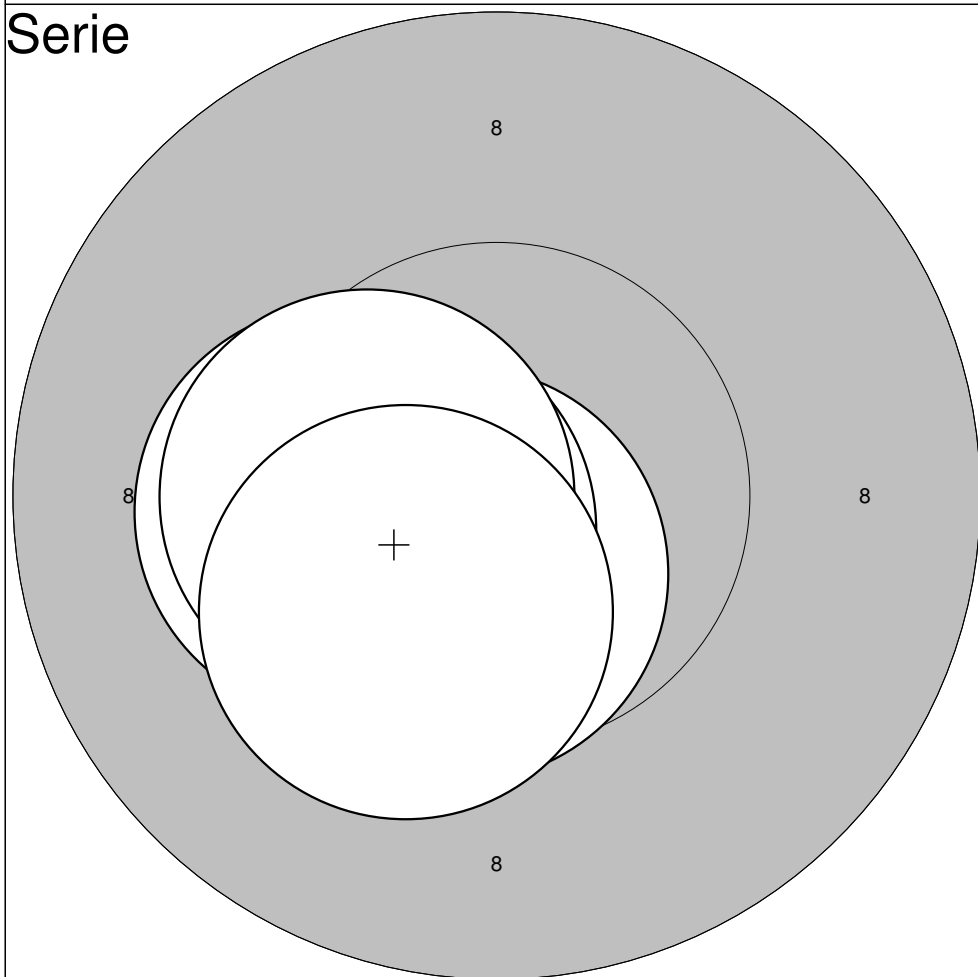

6: 10,3*	←
7: 10,6*	↘
8: 10,5*	←
9: 10,4*	←
10: 10,3*	↘

**Serie: 52,1**

**Summa: 491,2**

**Serie**

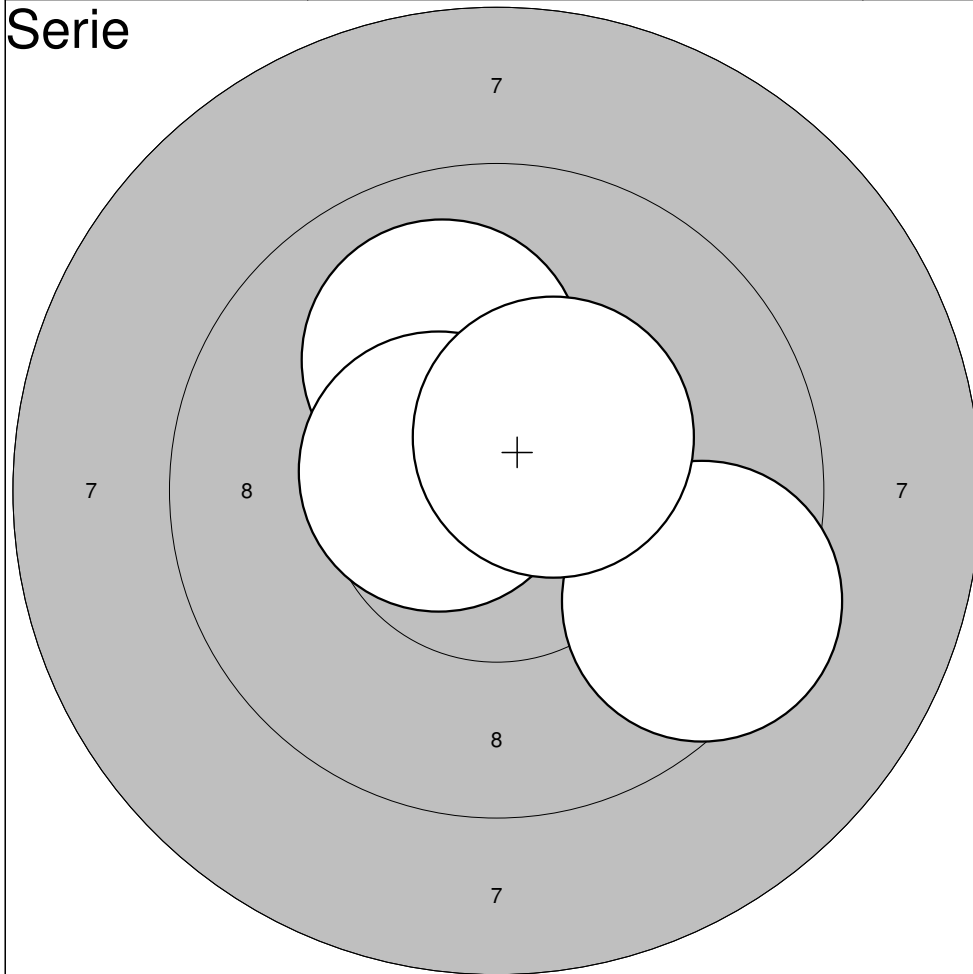

1: 9,5	↘
2: 10,2*	↗
3: 10,0	↗
4: 10,6*	↖
5: 10,5*	↗

**Serie: 50,8**

**Summa: 439,8**

**Serie**

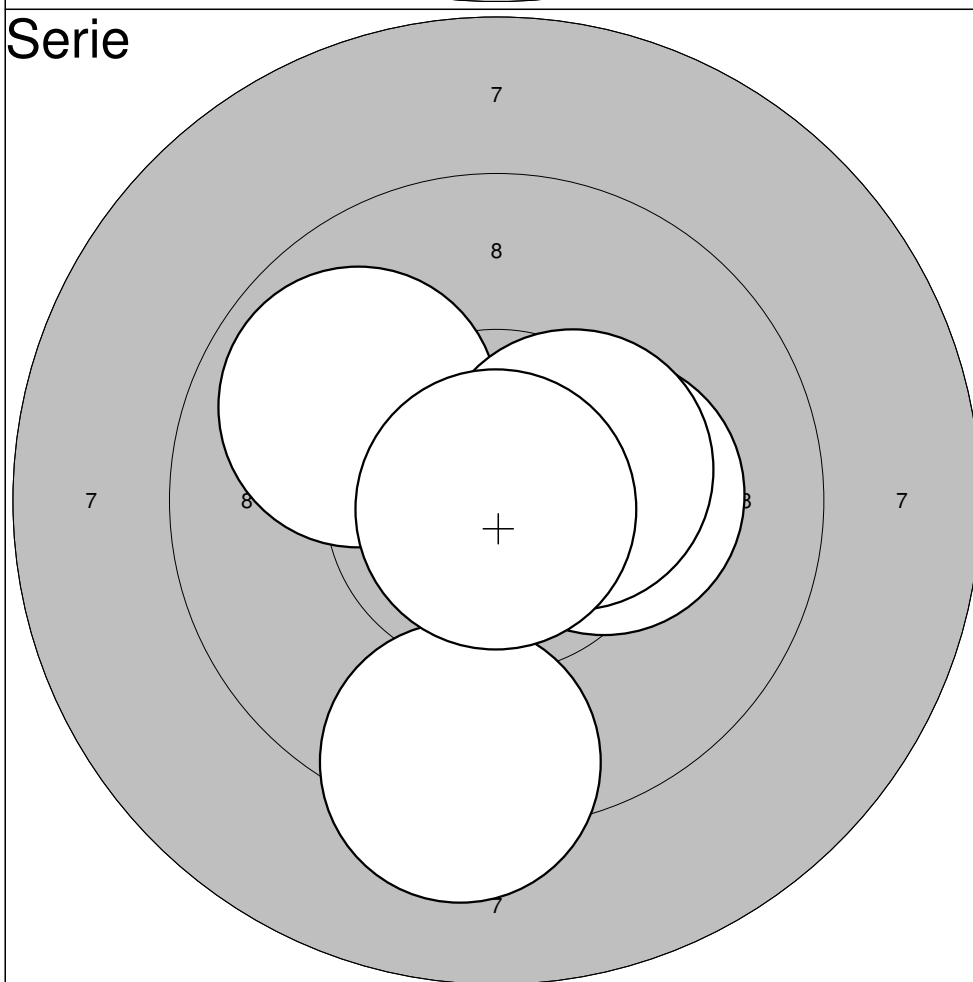

6: 9,9	↖
7: 9,3	↓
8: 10,3*	→
9: 10,4*	↗
10: 10,9*	↓

**Serie: 50,8**

**Summa: 490,6**

**Serie**

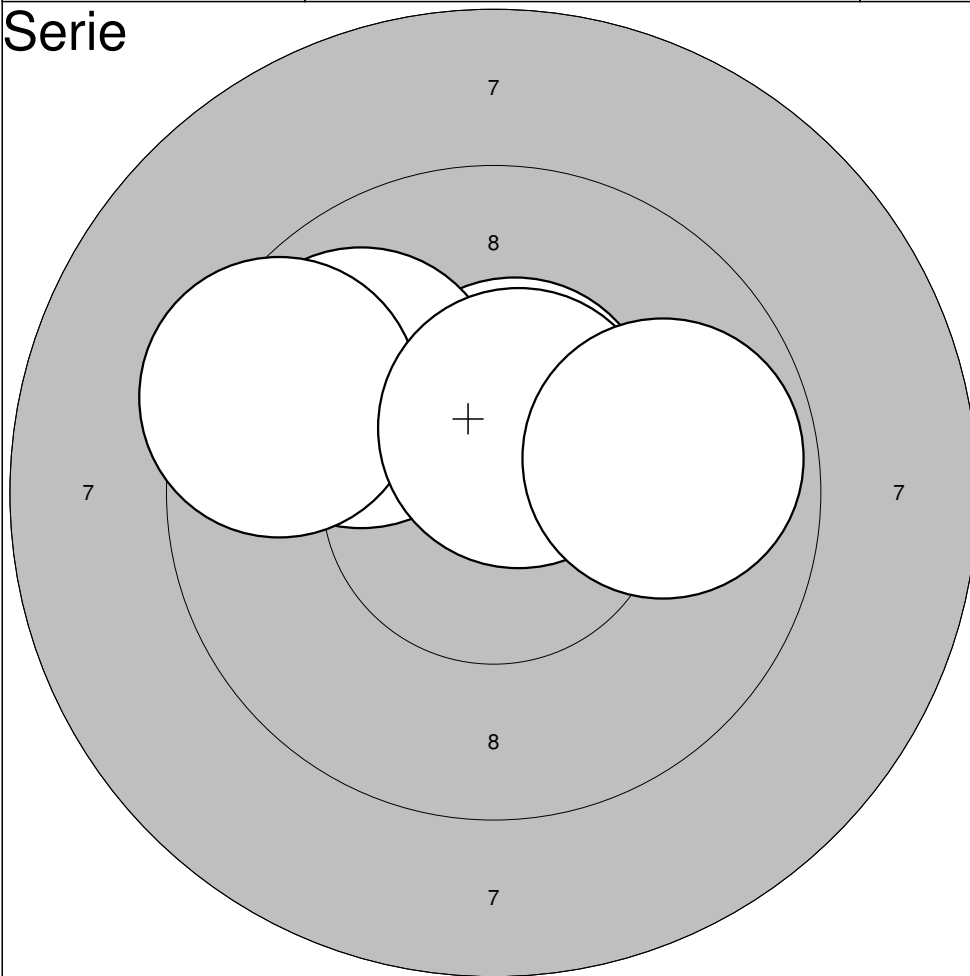

- 1: 10,5\* ↗
- 2: 9,9 ↖
- 3: 9,4 ↖
- 4: 10,5\* ↗
- 5: 9,8 →

**Serie: 50,1**

**Summa: 439,1**

**Serie**

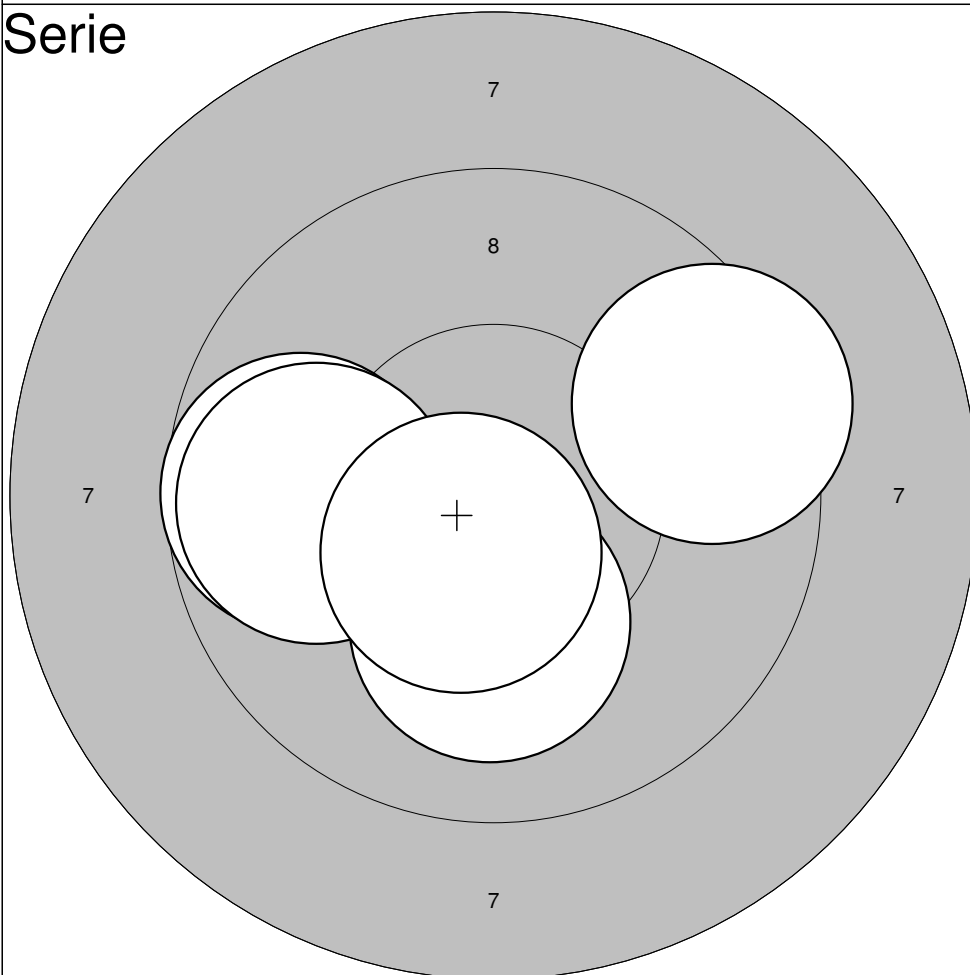

- 6: 9,7 ←
- 7: 9,8 ←
- 8: 10,1 ↓
- 9: 10,5\* ↘
- 10: 9,4 →

**Serie: 49,5**

**Summa: 488,6**

### Serie

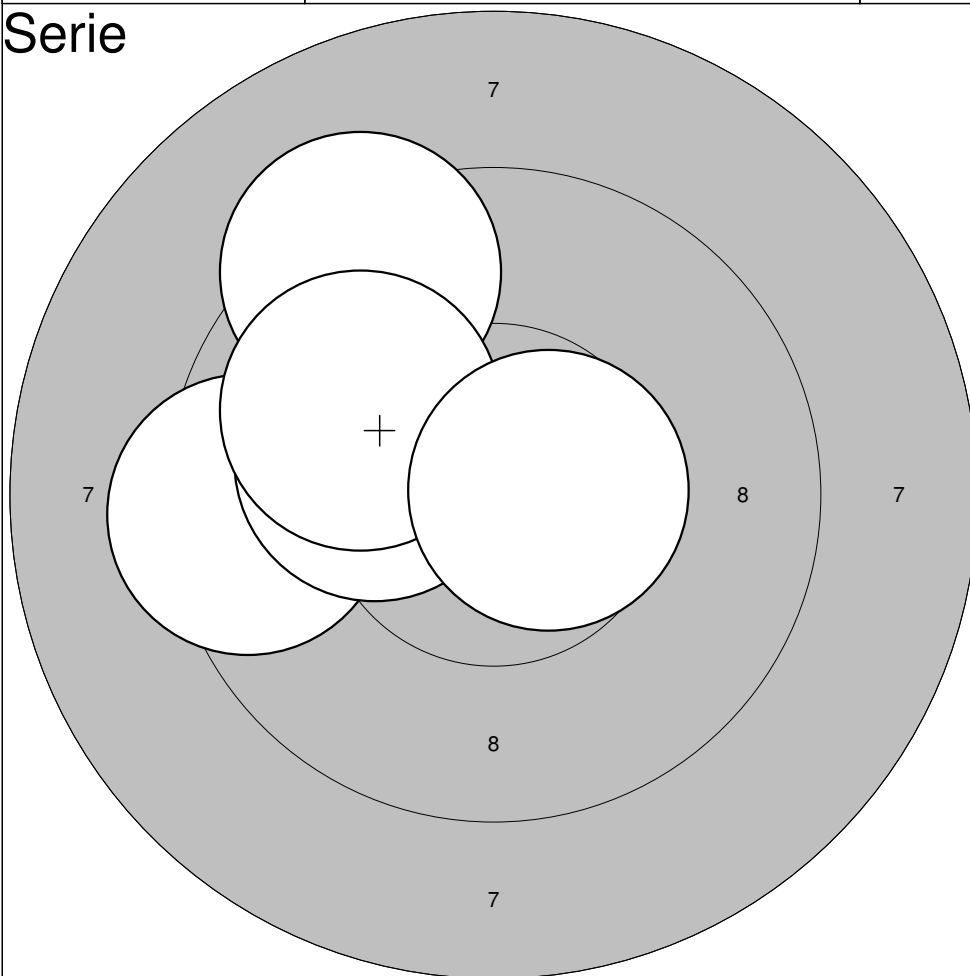

- 1: 9,4 ←
- 2: 9,3 ↗
- 3: 10,2\* ←
- 4: 9,9 ↗
- 5: 10,6\* →

Serie: 49,4

Summa: 438,4

### Serie

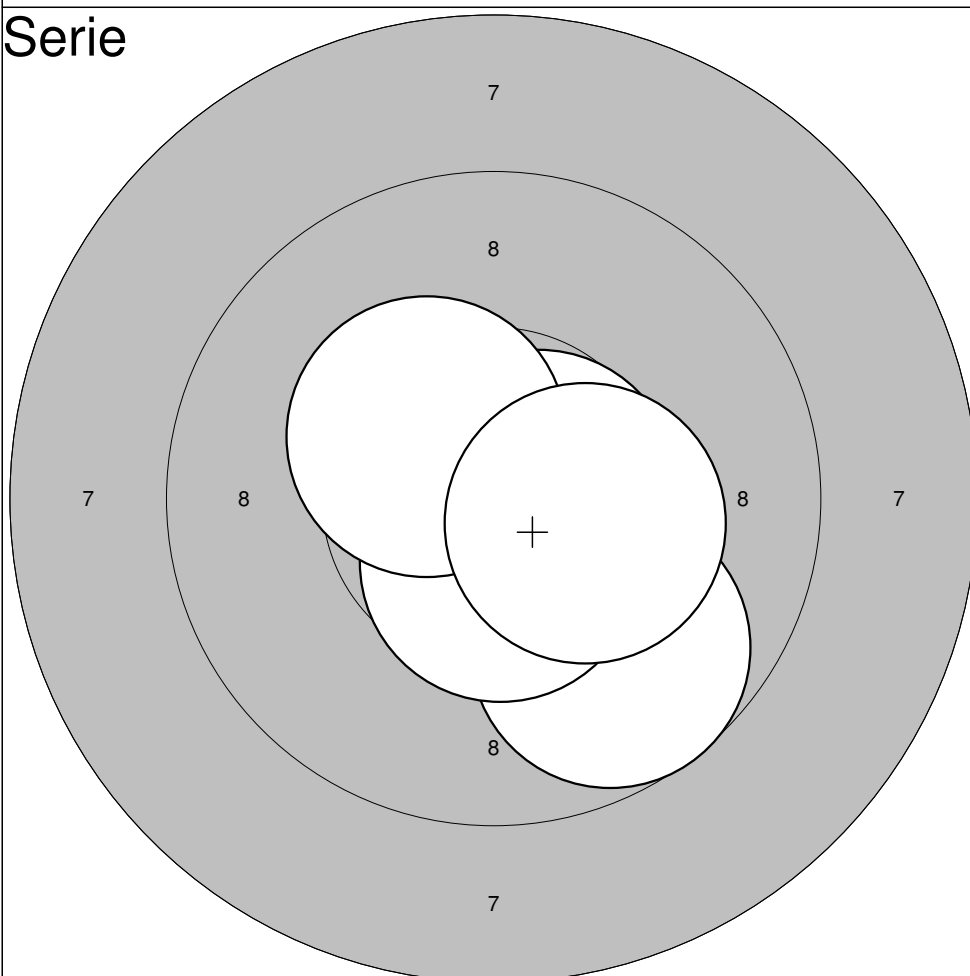

- 6: 10,7\* →
- 7: 9,7 ↘
- 8: 10,5\* ↘
- 9: 10,4\* ↗
- 10: 10,3\* →

Serie: 51,6

Summa: 490,0

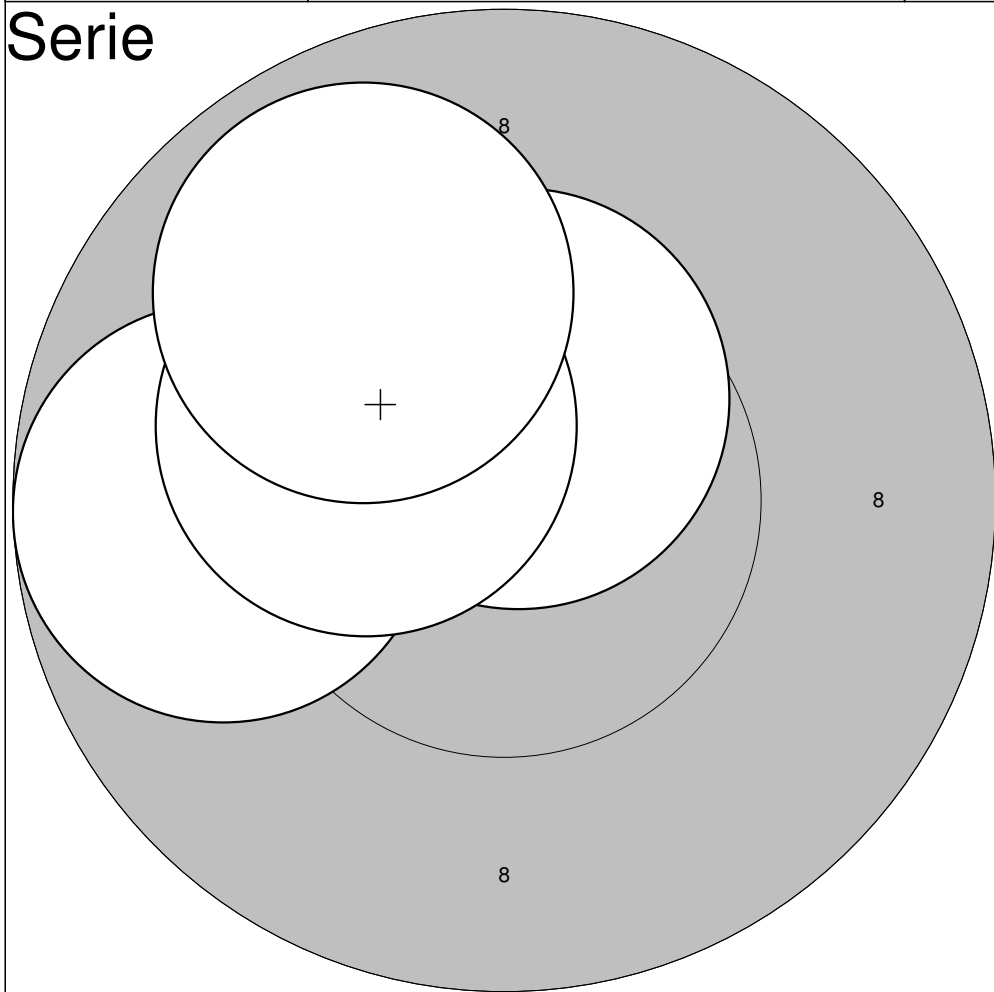

1: 10,4*	↗
2: 9,8	←
3: 10,5*	↗
4: 10,3*	↗
5: 9,9	↗

**Serie: 50,9**

**Summa: 432,9**

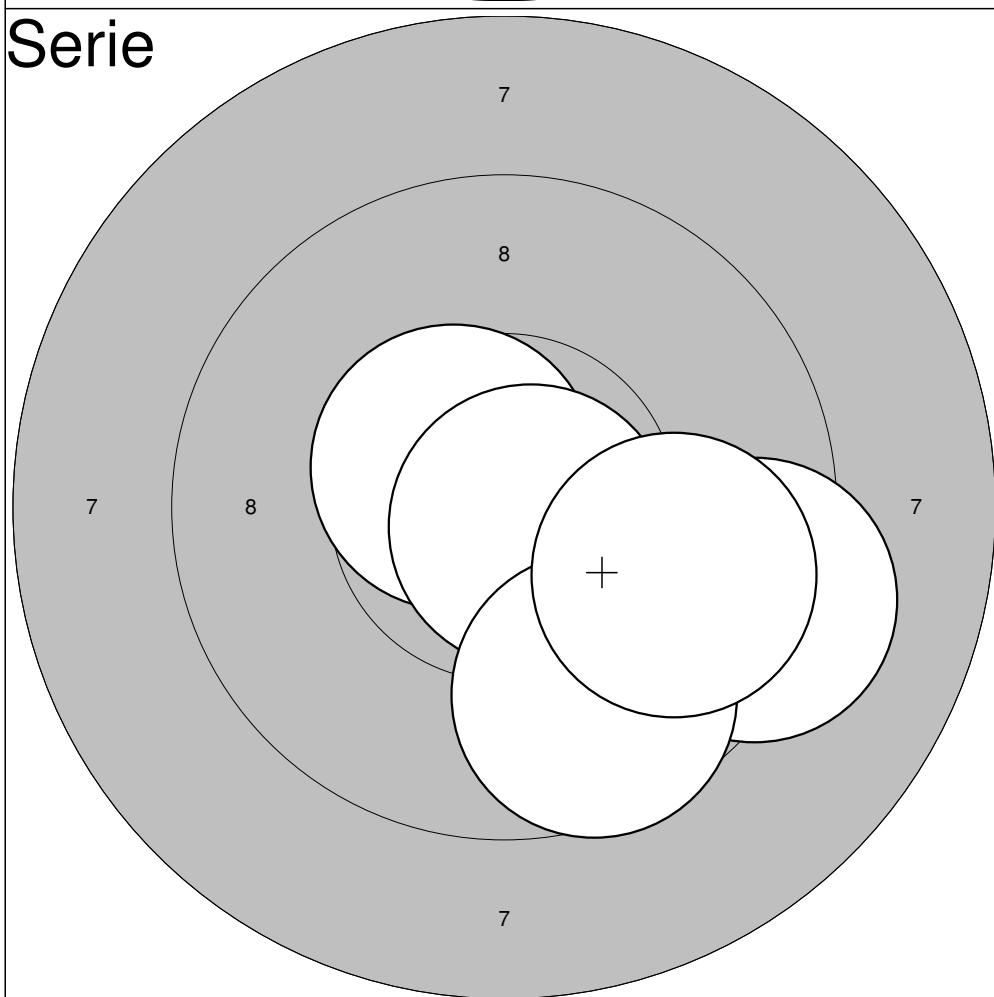

6: 10,5*	↗
7: 9,3	↘
8: 10,7*	↘
9: 9,6	↘
10: 9,8	↘

**Serie: 49,9**

**Summa: 482,8**

**Serie**

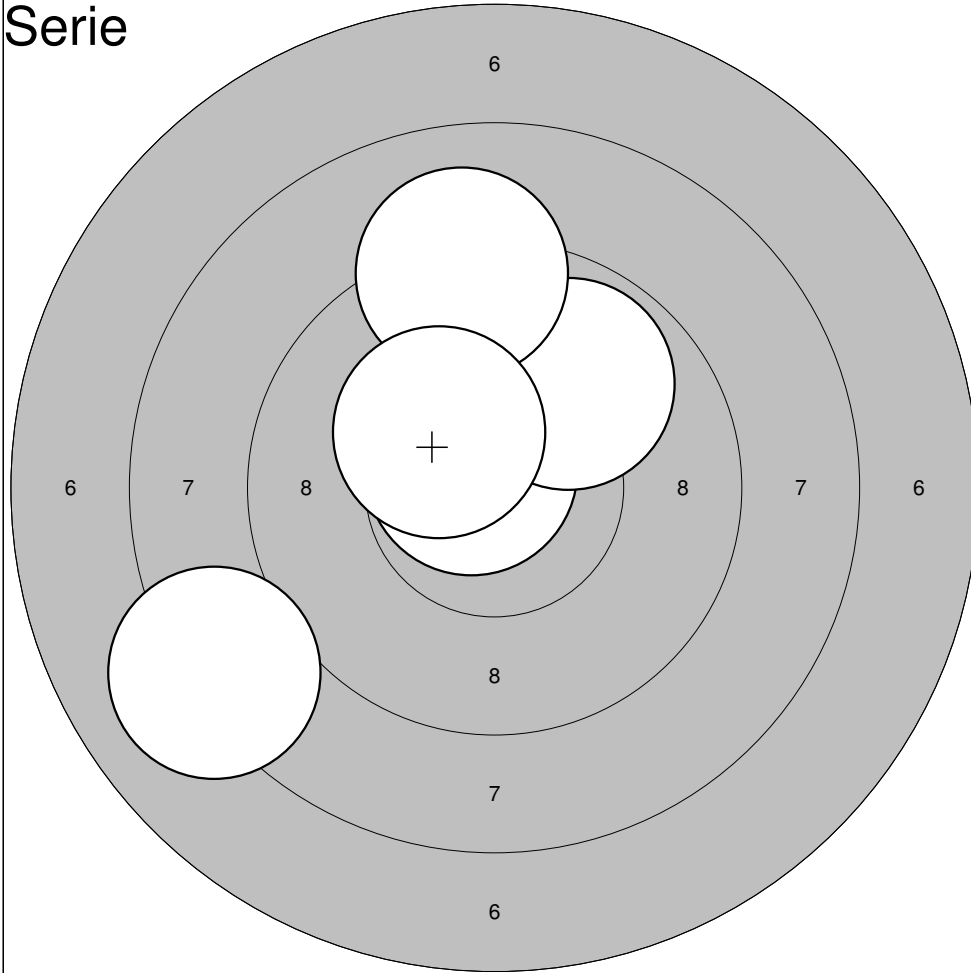

- 1: 10,7\* ↖
- 2: 9,9 ↗
- 3: 8,1 ↙
- 4: 9,1 ↑
- 5: 10,3\* ↖

**Serie: 48,1**

**Summa: 426,1**

**Serie**

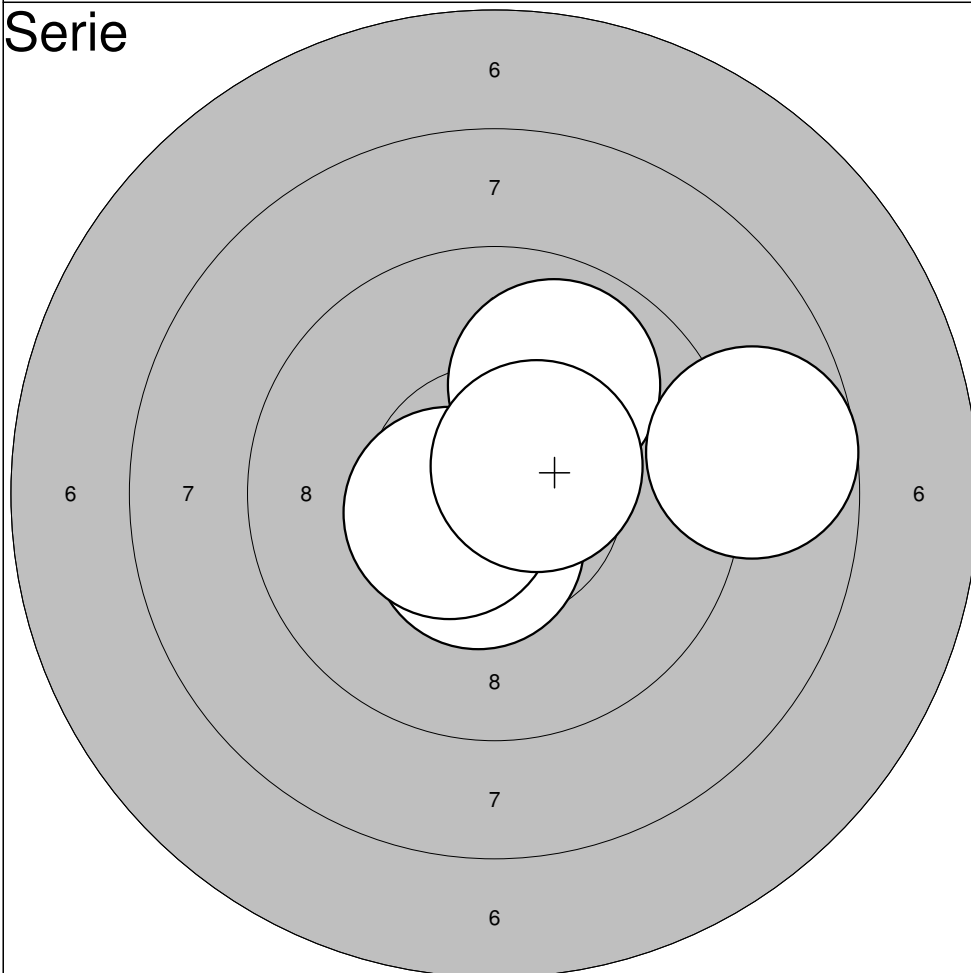

- 6: 10,5\* ↓
- 7: 10,5\* ↙
- 8: 9,9 ↗
- 9: 8,7 →
- 10: 10,5\* ↗

**Serie: 50,1**

**Summa: 476,2**

### Serie

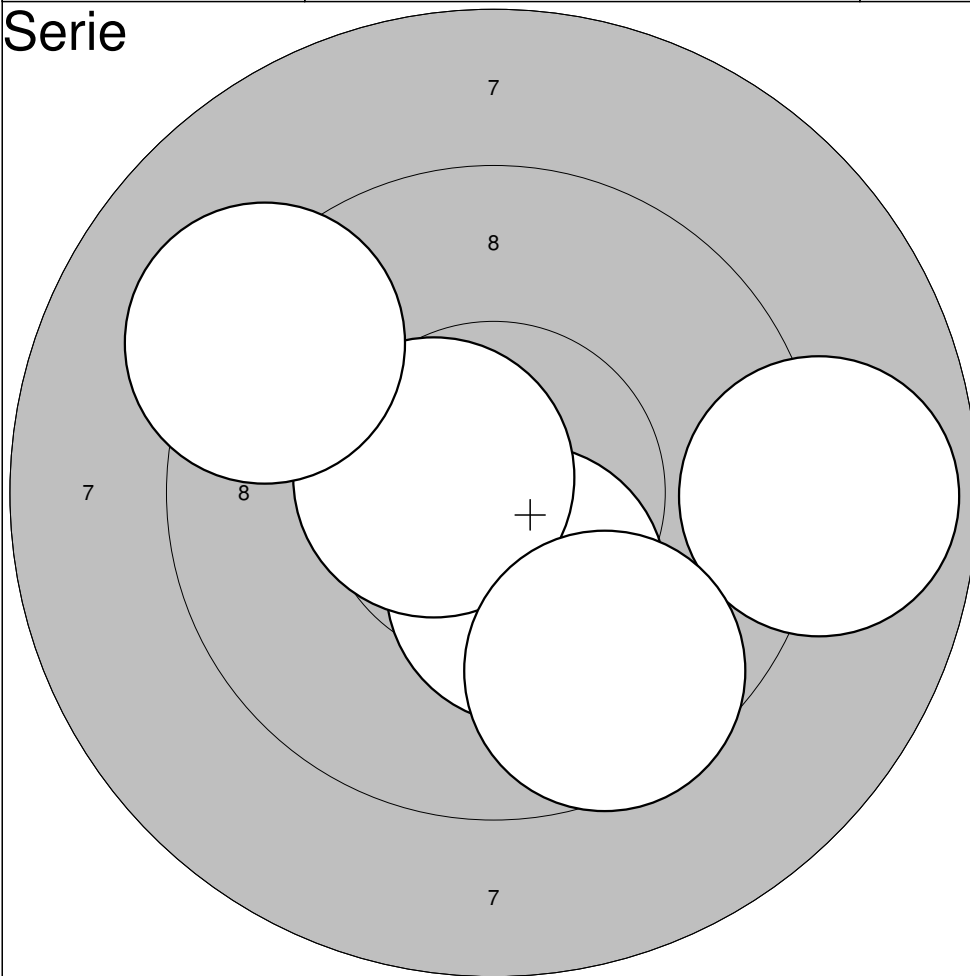

1: 10,3\* ↓

2: 8,9 →

3: 10,6\* ←

4: 9,6 ↓

5: 9,2 ↗

Serie: 48,6

Summa: 425,6

### Serie

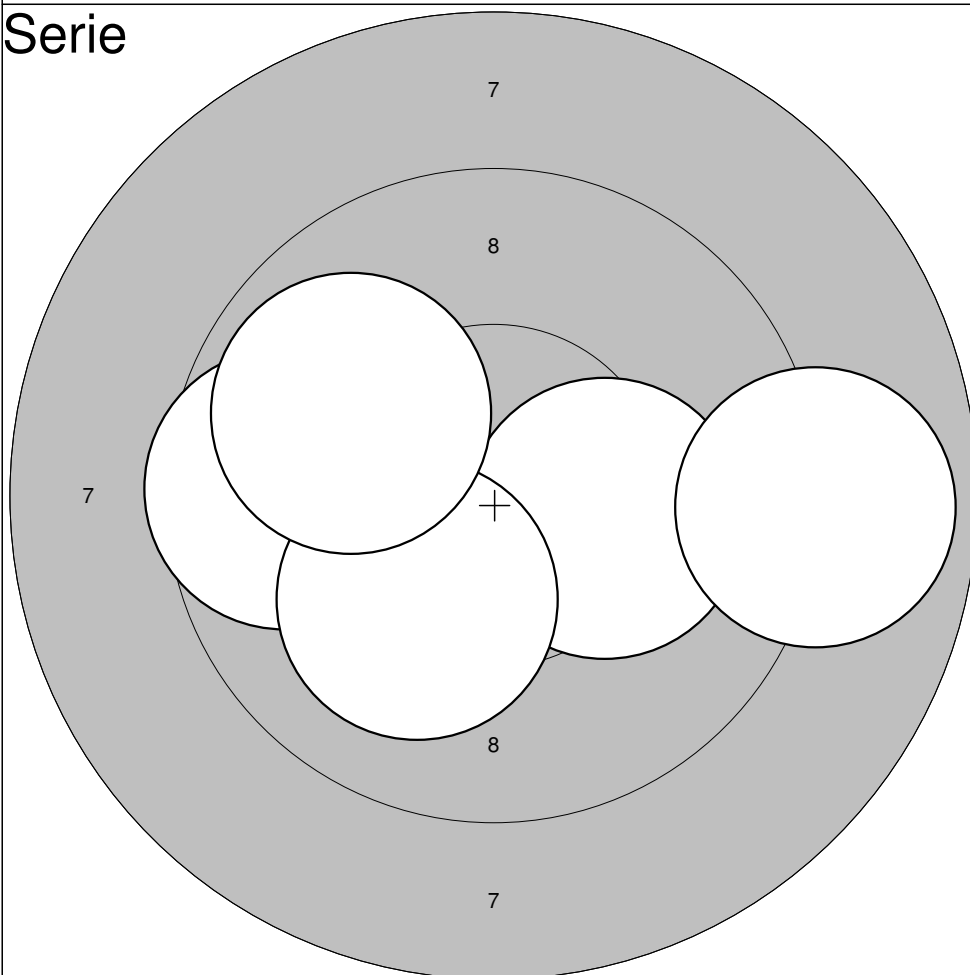

6: 10,2\* →

7: 9,6 ←

8: 10,1 ↘

9: 8,9 →

10: 9,9 ↗

Serie: 48,7

Summa: 474,3



**Serie**

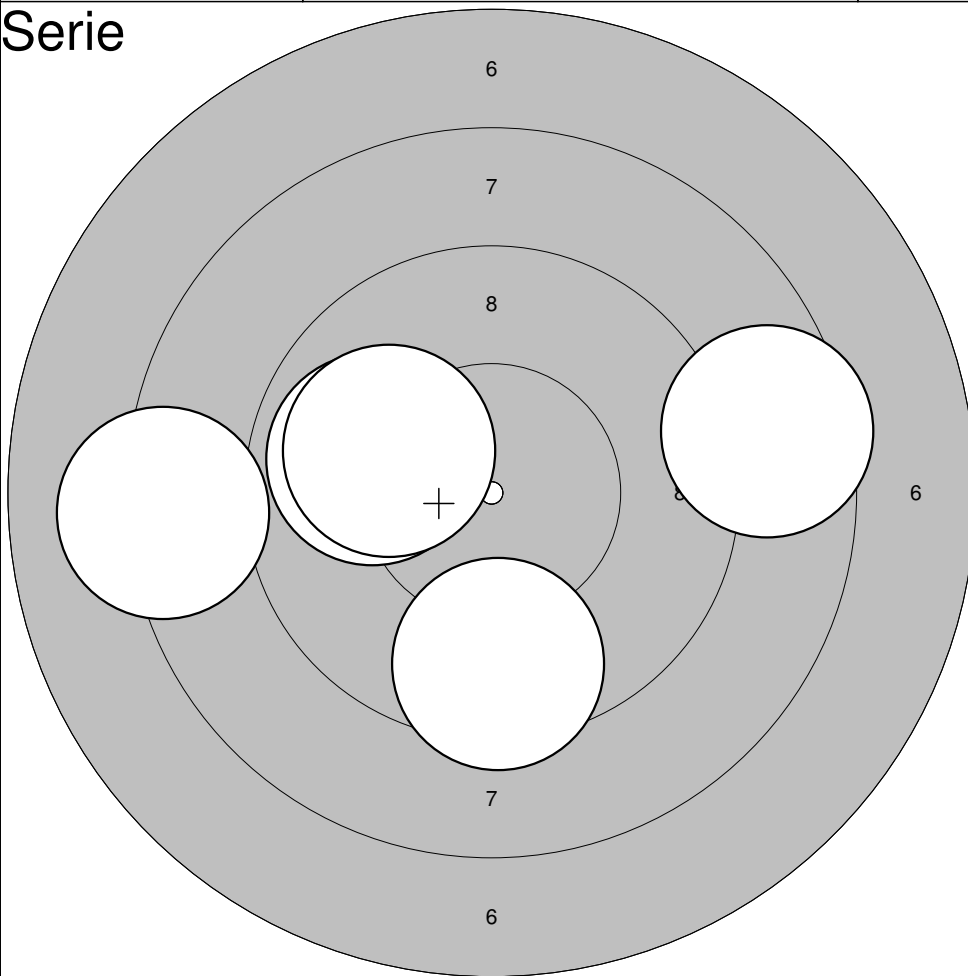

- 1: 8,2 ←
- 2: 9,9 ←
- 3: 8,6 →
- 4: 10,0 ←
- 5: 9,5 ↓

**Serie: 46,2**

**Summa: 423,2**

**Serie**

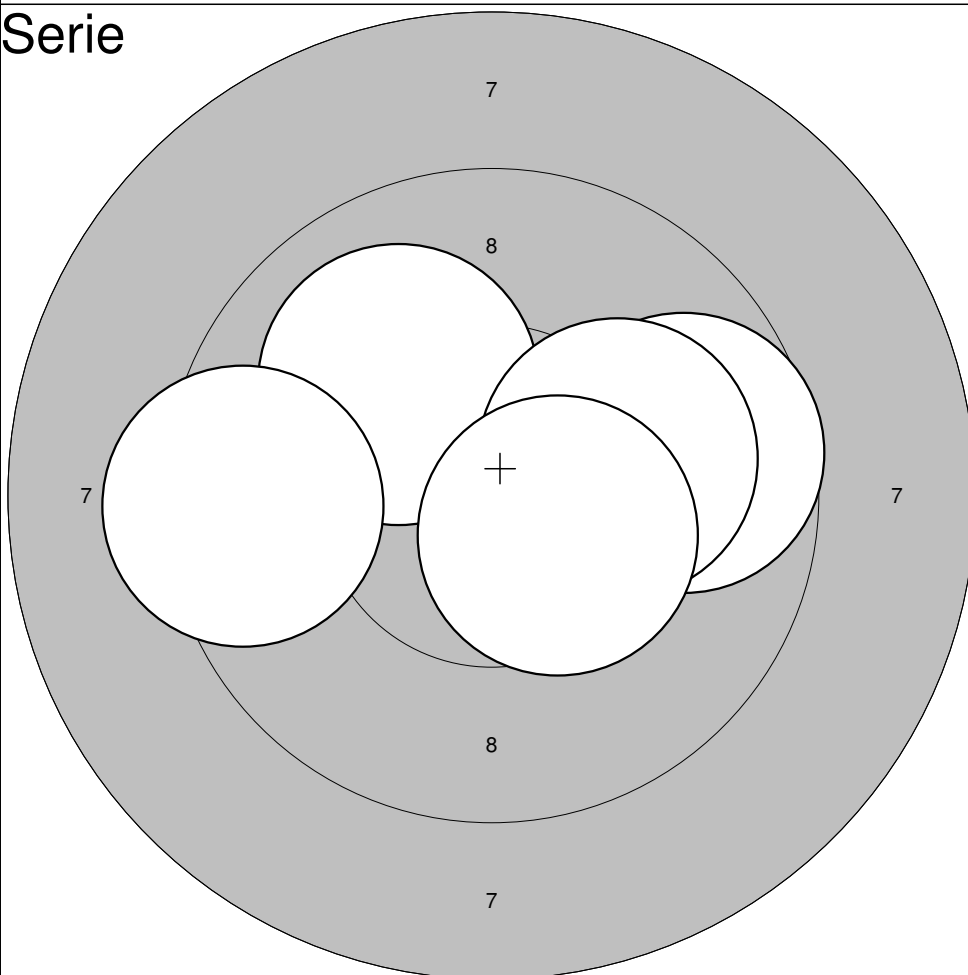

- 6: 10,0 ↖
- 7: 9,7 →
- 8: 10,1 →
- 9: 9,4 ←
- 10: 10,5\* ↘

**Serie: 49,7**

**Summa: 472,9**

**Serie**

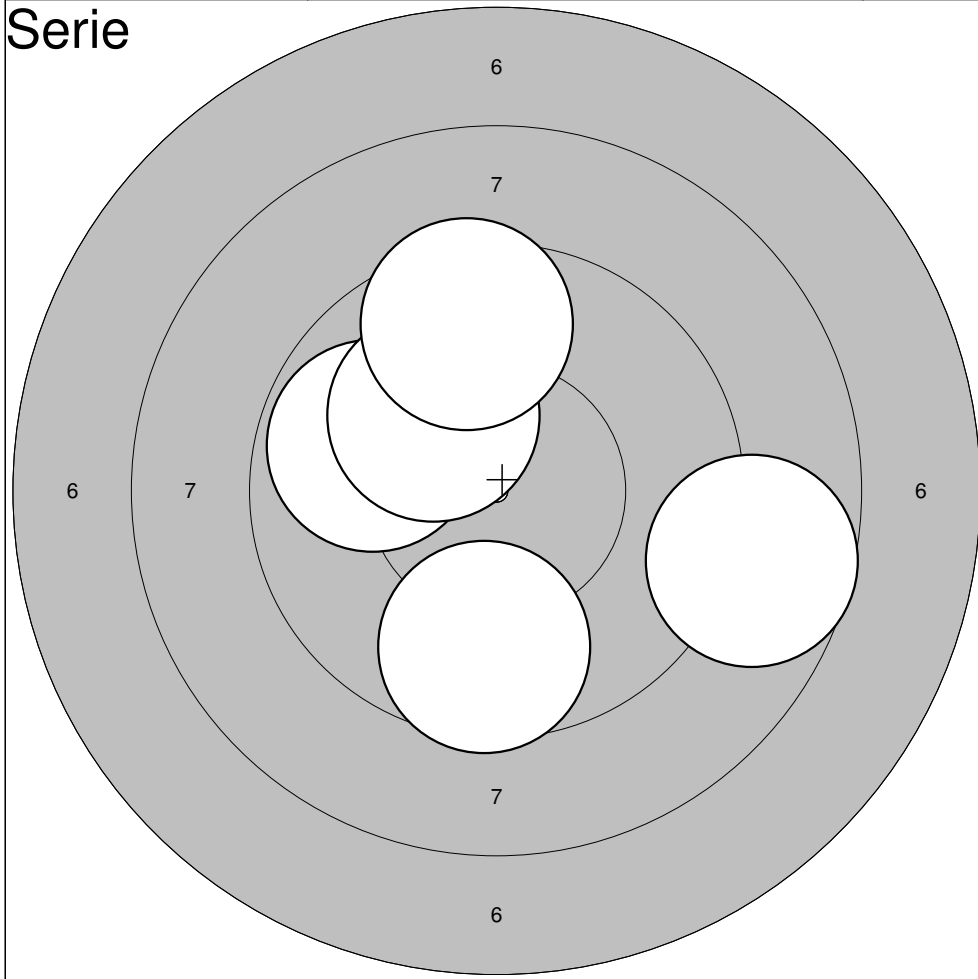

1: 9,8	↖
2: 10,1	↗
3: 8,7	→
4: 9,5	↑
5: 9,6	↓

**Serie: 47,7**

**Summa: 423,7**

**Serie**

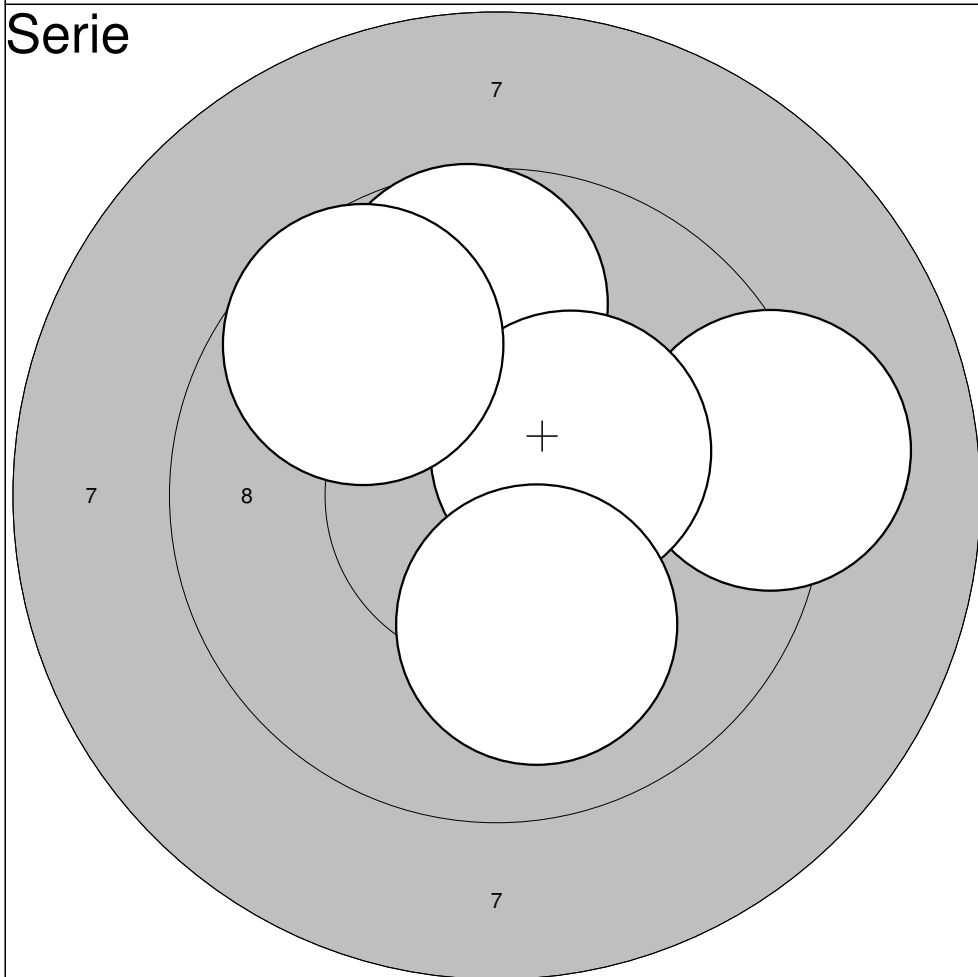

6: 9,7	↑
7: 9,2	→
8: 10,4*	↗
9: 10,1	↓
10: 9,7	↖

**Serie: 49,1**

**Summa: 472,8**

**Serie**

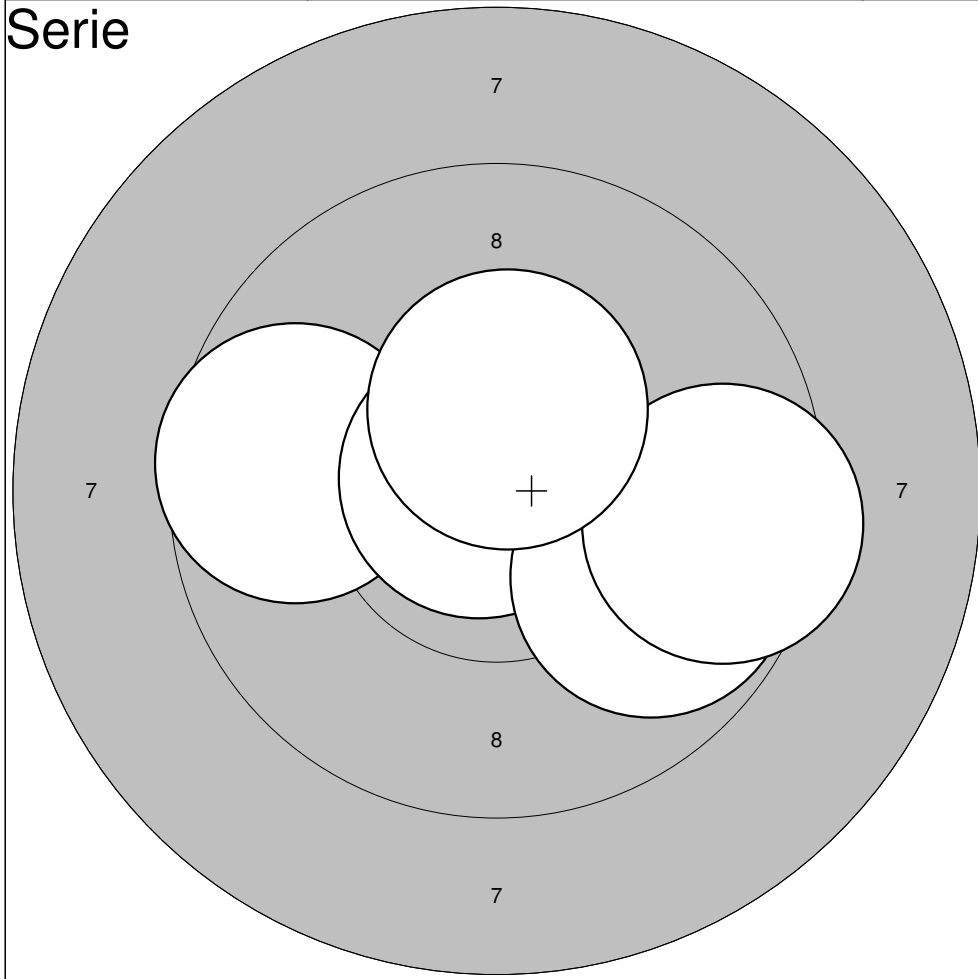

1: 9,7	←
2: 10,8*	↗
3: 9,8	↘
4: 9,5	→
5: 10,4*	↑

Serie:	50,2
Summa:	426,2

**Serie**

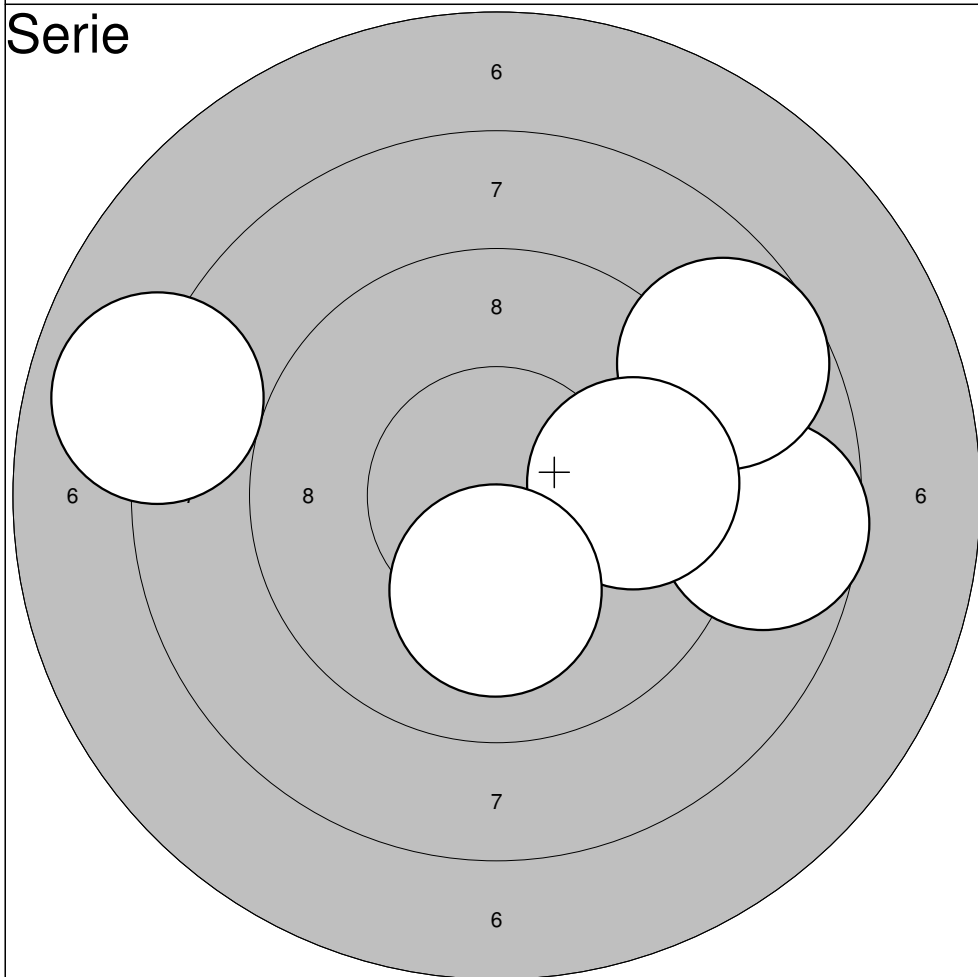

6: 8,7	→
7: 8,7	↗
8: 8,0	←
9: 9,8	→
10: 10,1	↓

Serie:	45,3
Summa:	471,5

**Serie**

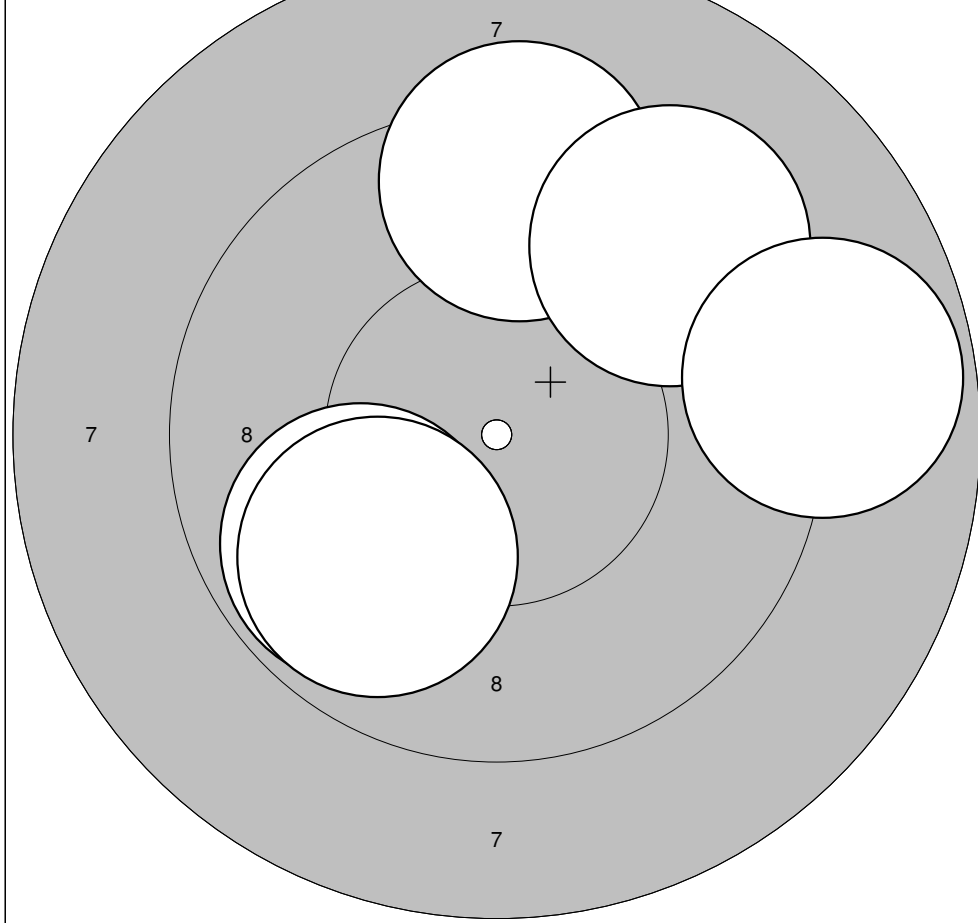

1:	9,8	↙
2:	9,3	↑
3:	9,3	↗
4:	9,9	↙
5:	8,8	→

Serie:	47,1
Summa:	421,1

**Serie**

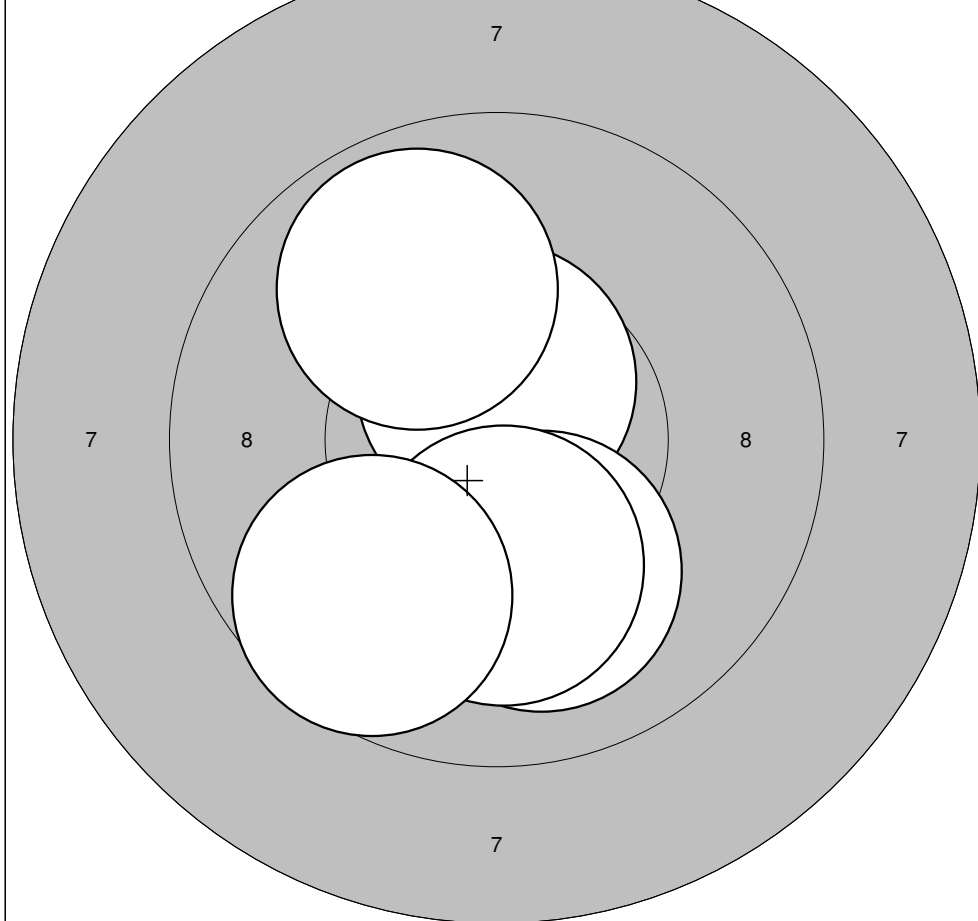

6:	10,6*	↑
7:	9,9	↖
8:	10,1	↘
9:	10,1	↓
10:	9,7	↙

Serie:	50,4
Summa:	471,5

**Serie**

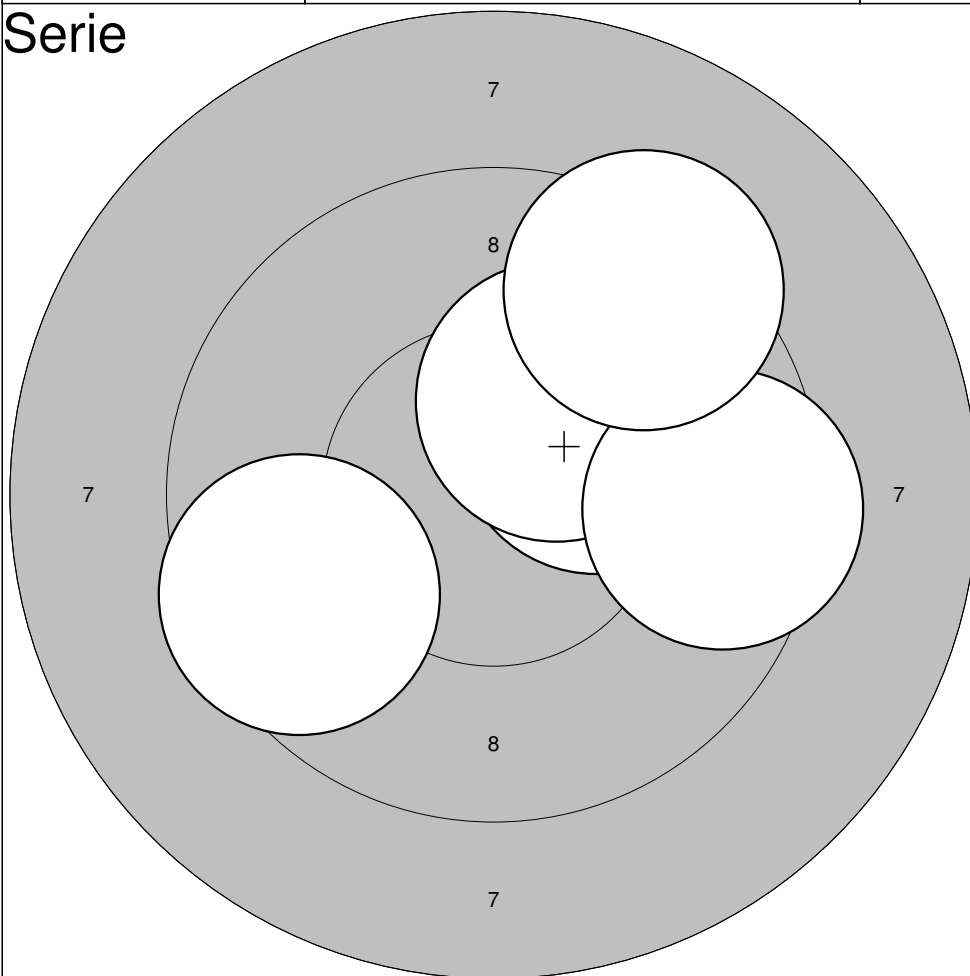

1: 10,2\* ↗

2: 10,2\* ↗

3: 9,5 →

4: 9,3 ↗

5: 9,6 ↙

**Serie: 48,8**

**Summa: 422,8**

**Serie**

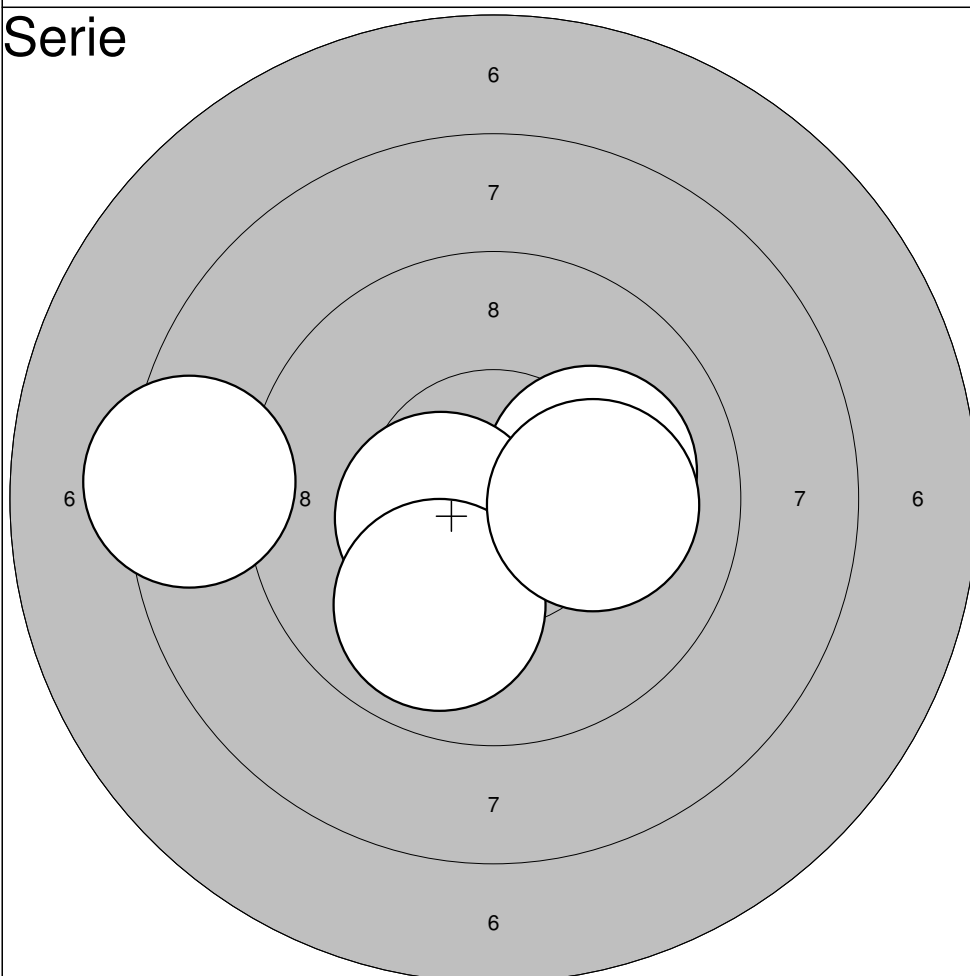

6: 10,1 →

7: 10,5\* ↙

8: 9,9 ↘

9: 10,1 →

10: 8,4 ↙

**Serie: 49,0**

**Summa: 471,8**

**Serie**

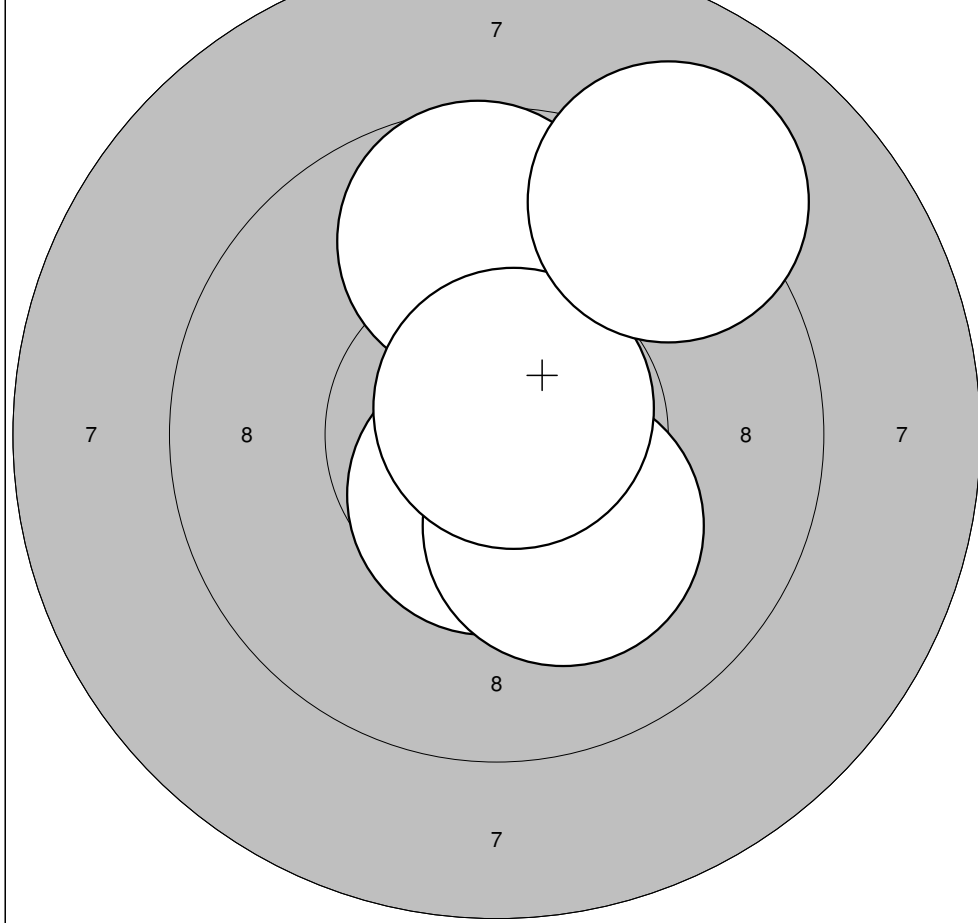

1:	10,6*	↓
2:	10,2*	↘
3:	9,7	↑
4:	10,7*	↗
5:	9,1	↗

**Serie: 50,3**

**Summa: 424,3**

**Serie**

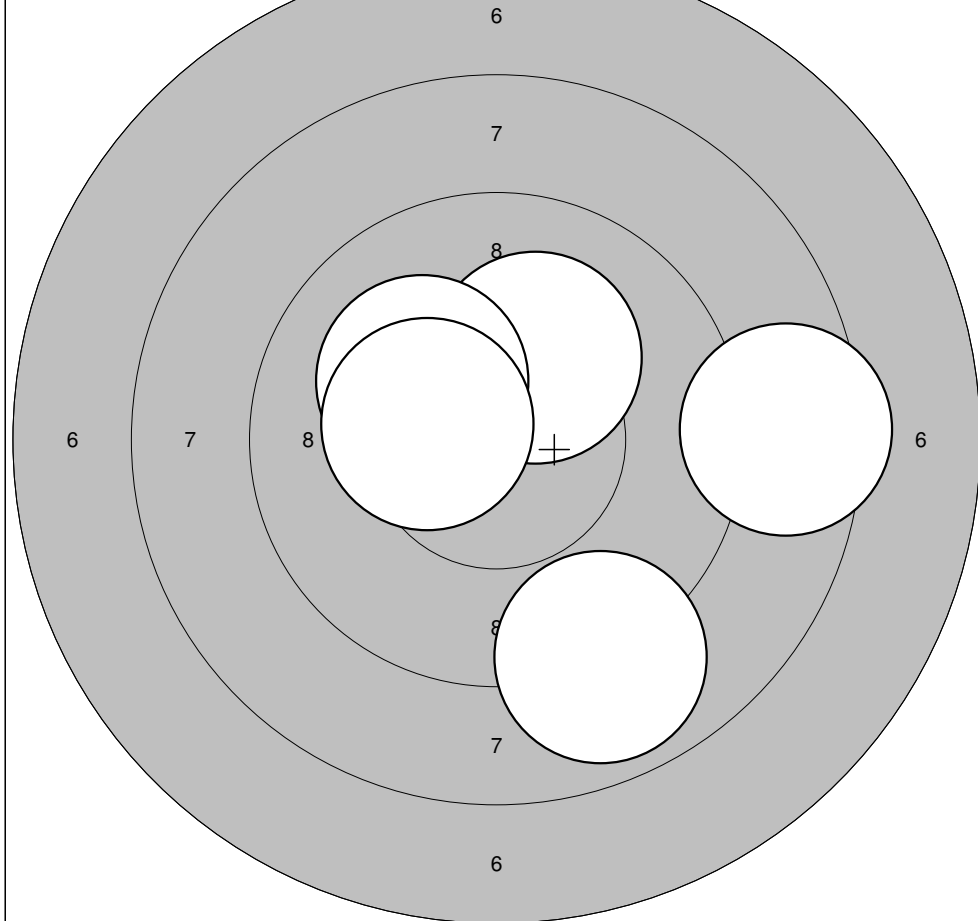

6:	10,2*	↗
7:	10,2*	↖
8:	8,5	→
9:	10,4*	↖
10:	8,9	↘

**Serie: 48,2**

**Summa: 472,5**

### Serie

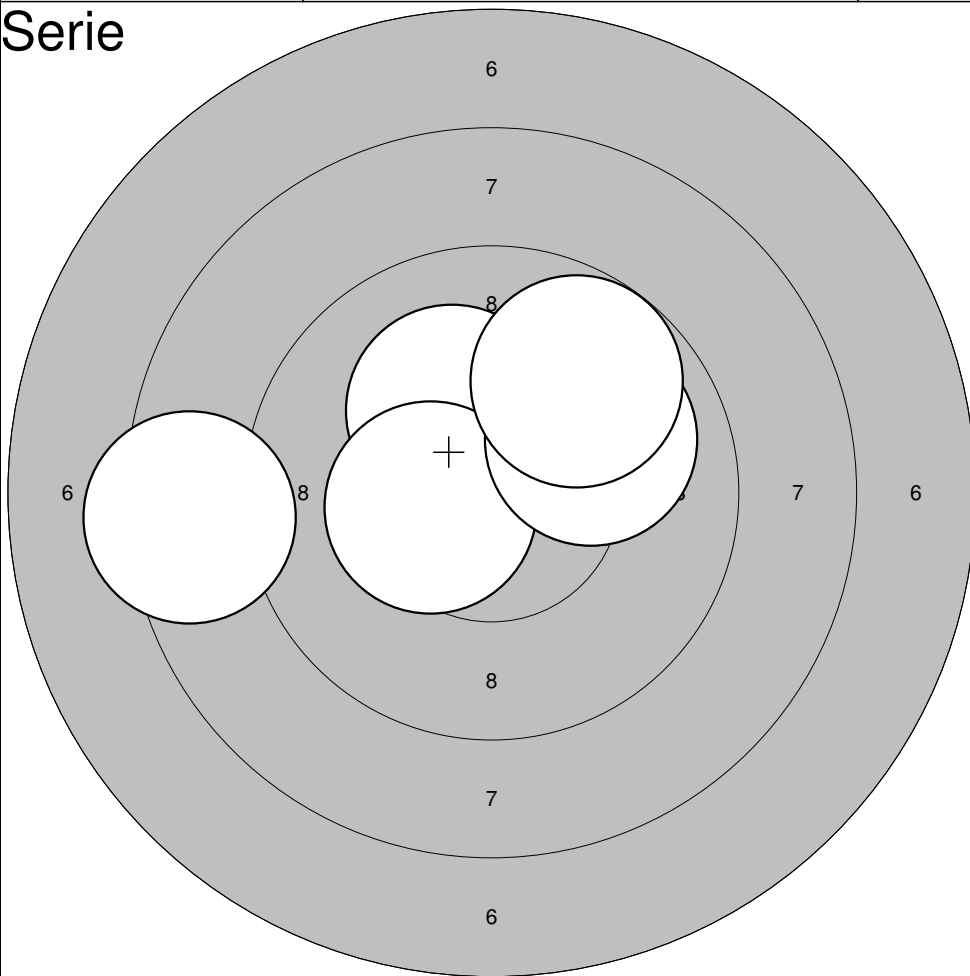

- 1: 10,2\* ↗
- 2: 10,4\* ←
- 3: 10,0 ↘
- 4: 9,8 ↗
- 5: 8,4 ←

Serie: 48,8

Summa: 421,8

### Serie

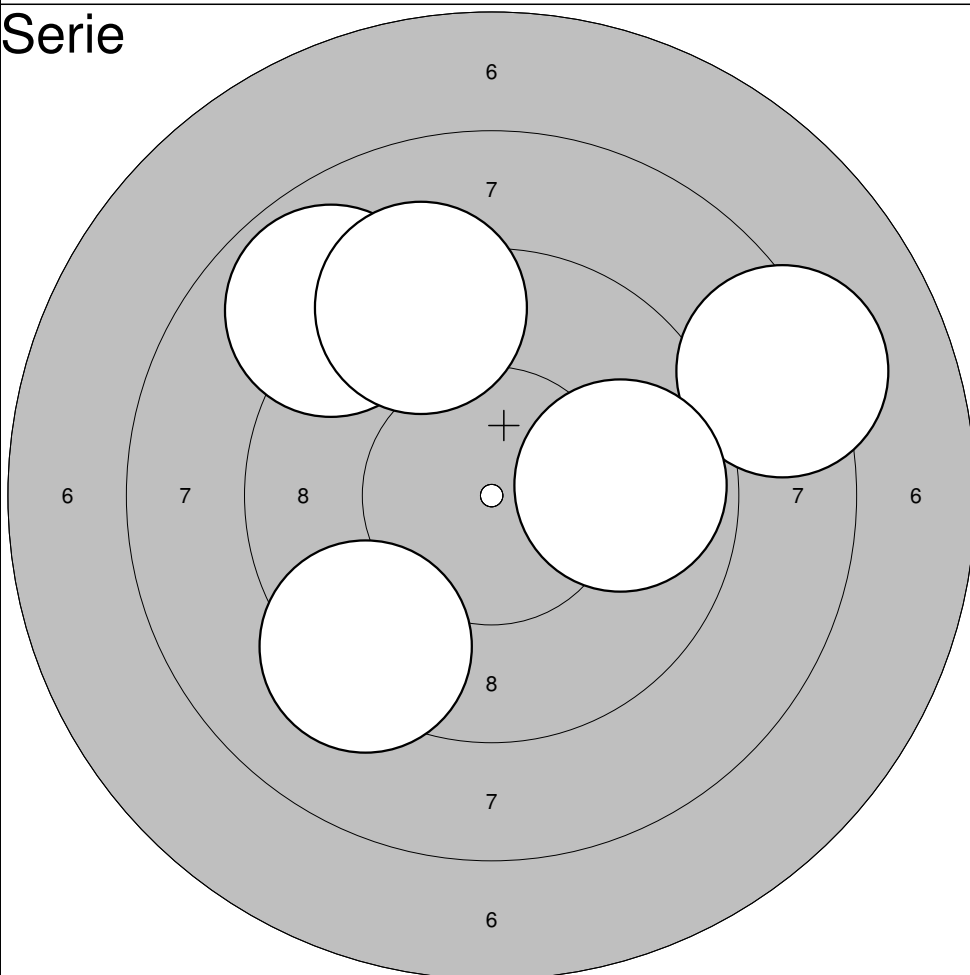

- 6: 8,3 ↘
- 7: 8,9 ↗
- 8: 9,9 →
- 9: 9,3 ↗
- 10: 9,3 ↘

Serie: 45,7

Summa: 467,5