

I 19 / A 9

2009-07-16

Tavelträffen 2009

Ramselefors SKF

Provskott

Provskott

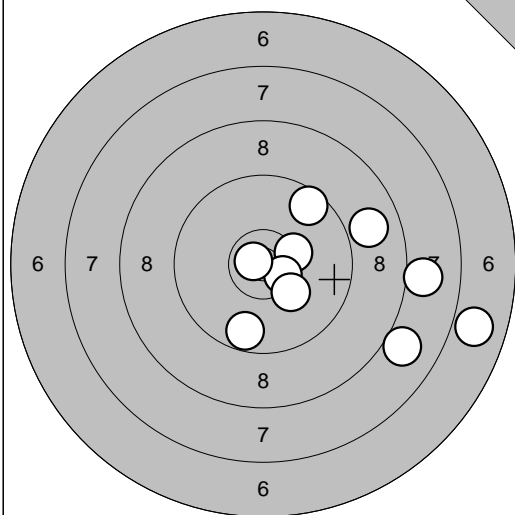

- 1: 9,7 ↓
- 2: 6,9 →
- 3: 8,0 ↓
- 4: 8,0 →
- 5: 8,9 →
- 6: 9,6 ↗
- 7: 10,3\* →
- 8: 10,5\* ↓
- 9: 10,2 ↓
- 10: 10,8\* ←

Serie 88,0  
Totalt 0,0

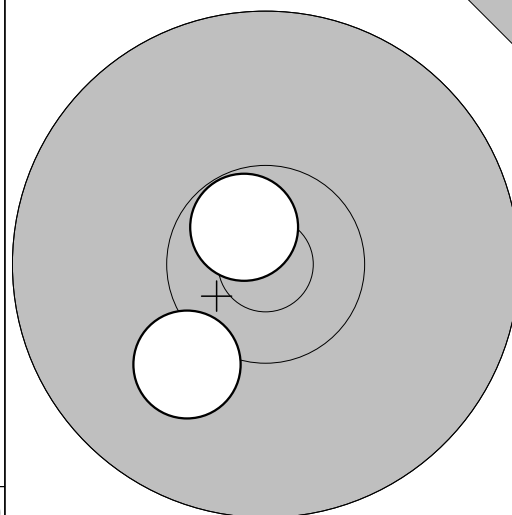

- 11: 10,1 ↘
- 12: 10,7\* ↗

Serie 20,0  
Totalt 0,0

Tävlingsskott

Tävlingsskott

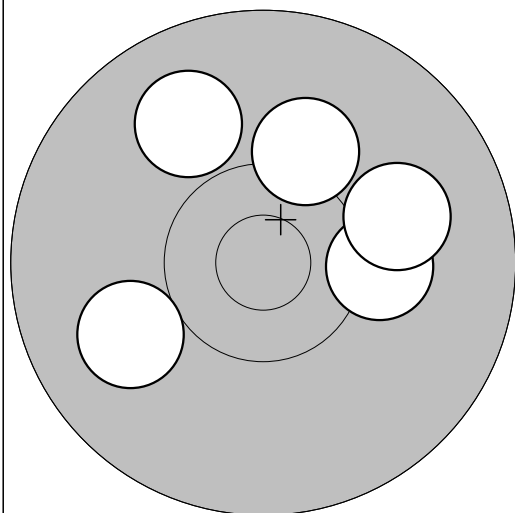

- 1: 10,2 →
- 2: 10,2 ↗
- 3: 9,9 ↗
- 4: 10,0 →
- 5: 10,0 ←

Serie 49,0  
Totalt 49,0

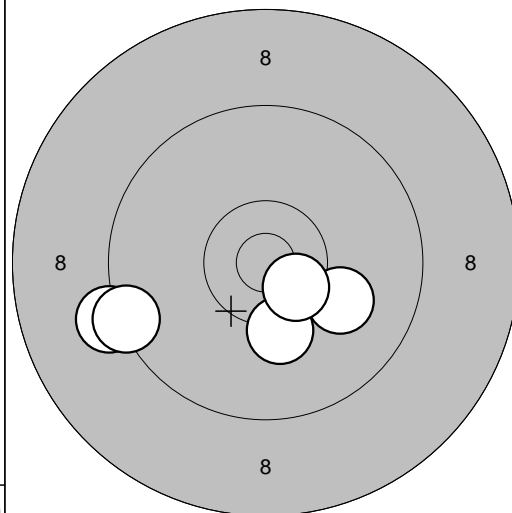

- 6: 9,2 ←
- 7: 9,4 ←
- 8: 10,2 ↓
- 9: 10,1 →
- 10: 10,5\* ↓

Serie 48,0  
Totalt 97,0

Tävlingsskott

Tävlingsskott

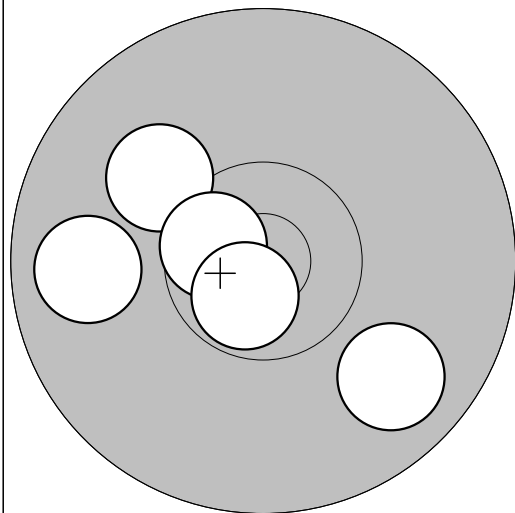

- 11: 10,1 ↗
- 12: 9,8 ←
- 13: 10,6\* ←
- 14: 9,8 ↓
- 15: 10,7\* ↓

Serie 48,0  
Totalt 145,0

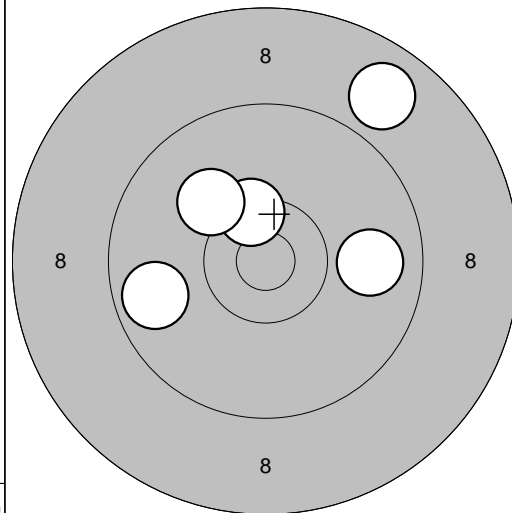

- 16: 10,4\* ↗
- 17: 9,9 →
- 18: 9,7 ←
- 19: 10,1 ↗
- 20: 8,8 ↗

Serie 46,0  
Totalt 191,0

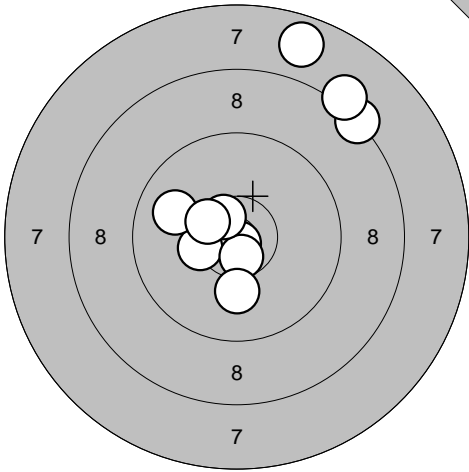
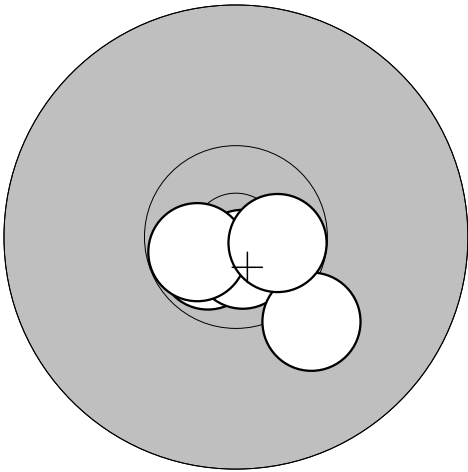
<b>Provs-kott</b> 	1: 7,8 ↗ 2: 8,3 ↗ 3: 8,2 ↗ 4: 10,8* ↓ 5: 10,4* ← 6: 9,9 ← 7: 10,6* ↓ 8: 10,6* ↗ 9: 10,1 ↓ 10: 10,4* ↖	<b>Tävlingsskott</b> 	1: 10,7* ↙ 2: 10,8* ↓ 3: 10,1 ↓ 4: 10,7* ↖ 5: 10,6* →
Serie 92,0	Serie 50,0	Serie 50,0	
Totalt 0,0	Totalt 50,0	Totalt 50,0	

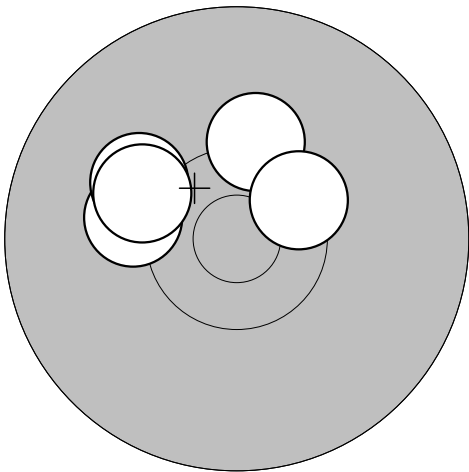
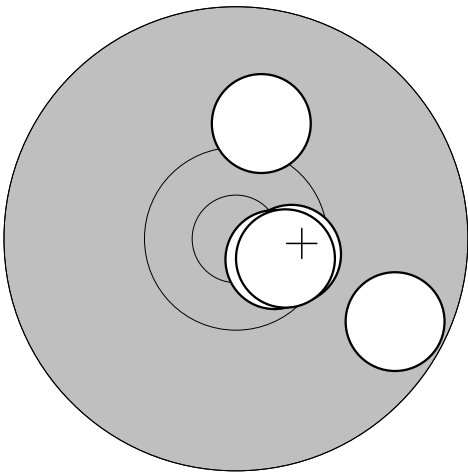
<b>Tävlingsskott</b> 	6: 10,2 ← 7: 10,3 ↑ 8: 10,4* ↗ 9: 10,2 ↖ 10: 10,2 ↖	<b>Tävlingsskott</b> 	11: 10,5* → 12: 10,6* ↘ 13: 9,7 ↘ 14: 10,1 ↑ 15: 10,6* ↘
Serie 50,0	Serie 49,0	Serie 49,0	
Totalt 100,0	Totalt 149,0	Totalt 149,0	

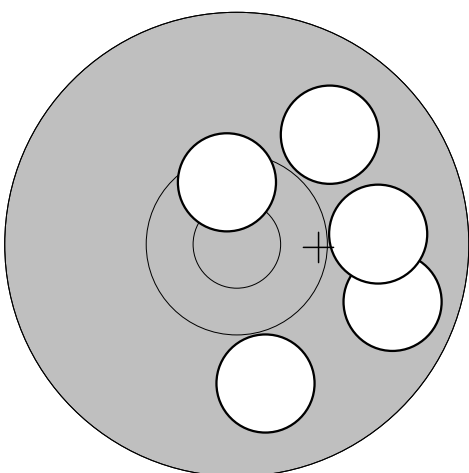
<b>Tävlingsskott</b> 	16: 9,9 ↗ 17: 9,8 → 18: 10,5* ↑ 19: 9,9 ↓ 20: 9,9 →		
Serie 46,0	Serie 46,0		
Totalt 195,0	Totalt 195,0		

S 3

2009-07-16

Tavelträffen 2009

Ramselefors SKF

Provs-kott

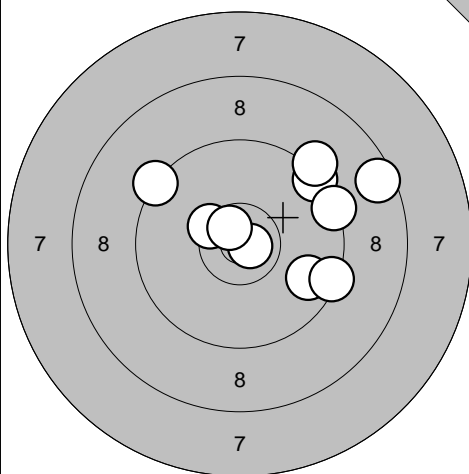

- 1: 9,7 ↘
- 2: 9,4 ↗
- 3: 9,2 ↗
- 4: 8,6 ↗
- 5: 9,4 ↗
- 6: 9,3 ↗
- 7: 10,8\* →
- 8: 10,4\* ↗
- 9: 10,7\* ↗
- 10: 9,4 →

Serie 92,0

Totalt 0,0

Provs-kott

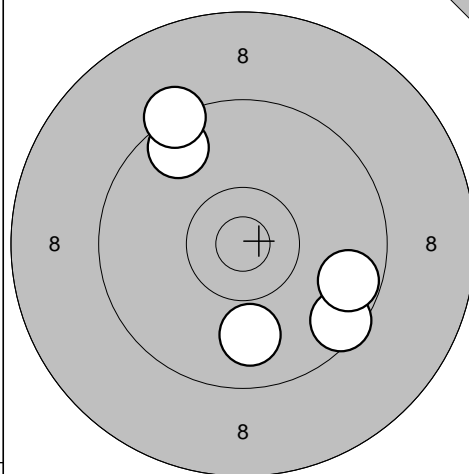

- 11: 9,5 ↘
- 12: 9,7 ↘
- 13: 9,6 ↗
- 14: 9,9 ↓
- 15: 9,3 ↗

Serie 45,0

Totalt 0,0

Tävlingsskott

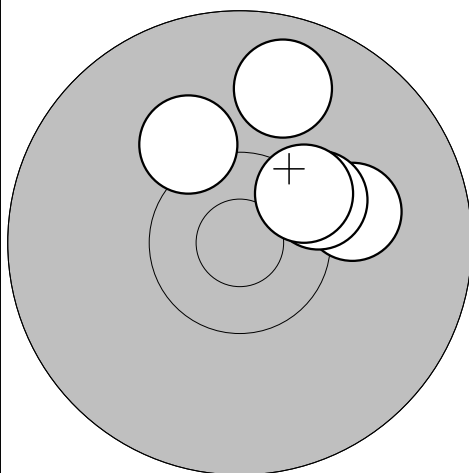

- 1: 10,1 →
- 2: 9,8 ↑
- 3: 10,3\* →
- 4: 10,2 ↗
- 5: 10,4\* ↗

Serie 49,0

Totalt 49,0

Tävlingsskott

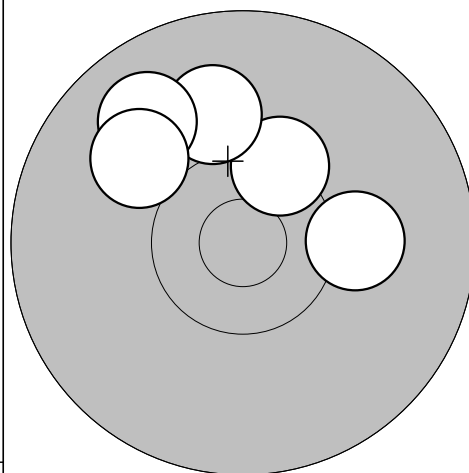

- 6: 10,3\* ↗
- 7: 10,0 ↑
- 8: 9,9 ↗
- 9: 10,2 →
- 10: 10,0 ↗

Serie 49,0

Totalt 98,0

Tävlingsskott

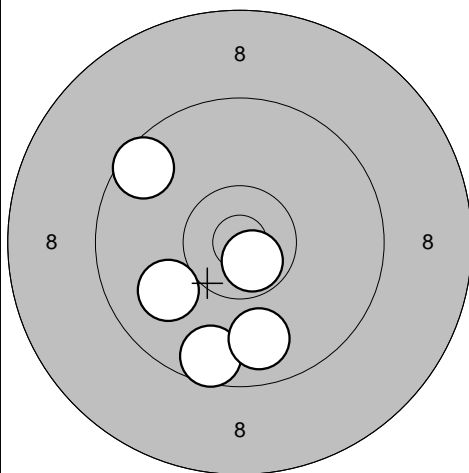

- 11: 10,0 ↙
- 12: 10,7\* ↘
- 13: 9,6 ↓
- 14: 9,8 ↓
- 15: 9,6 ↗

Serie 47,0

Totalt 145,0

Tävlingsskott

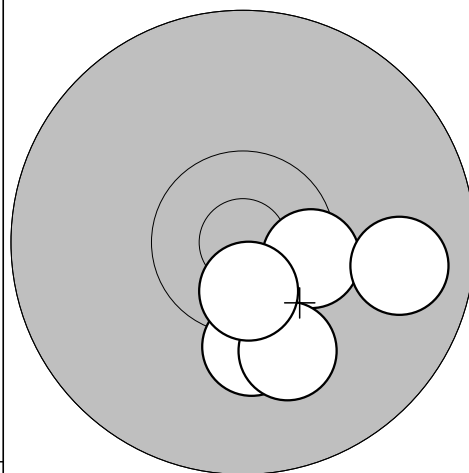

- 16: 10,4\* →
- 17: 10,2 ↓
- 18: 10,1 ↓
- 19: 9,8 →
- 20: 10,6\* ↓

Serie 49,0

Totalt 194,0

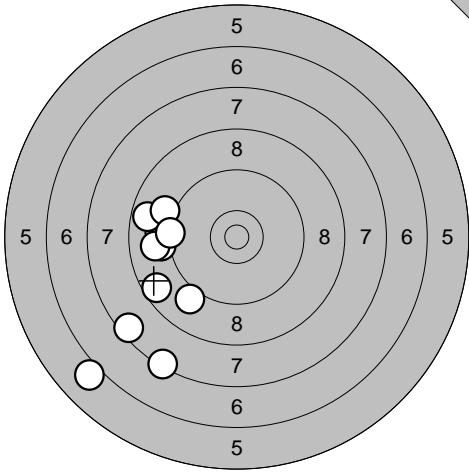
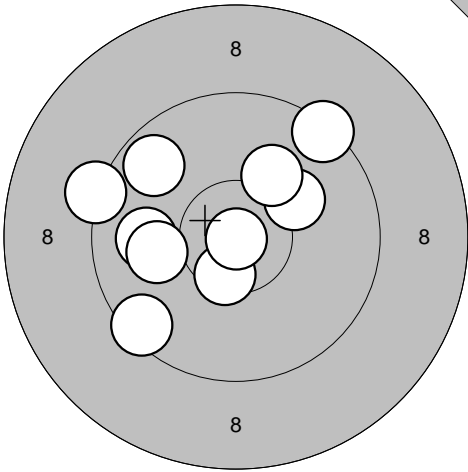
<p>Provs-kott</p> 	<p>1: 7,5 ↙ 2: 8,6 ↙ 3: 9,1 ← 4: 9,1 ↙ 5: 6,0 ↙ 6: 9,0 ← 7: 7,4 ↙ 8: 8,7 ← 9: 9,1 ↙ 10: 9,3 ←</p> <p>Serie 81,0 Totalt 0,0</p>	<p>Provs-kott</p> 	<p>11: 9,9 ← 12: 10,2 ↗ 13: 9,4 ↗ 14: 9,7 ↙ 15: 10,1 ↗ 16: 10,0 ← 17: 10,5* ↓ 18: 9,3 ← 19: 10,9* ↓ 20: 9,5 ↙</p> <p>Serie 95,0 Totalt 0,0</p>
--	--	--	--

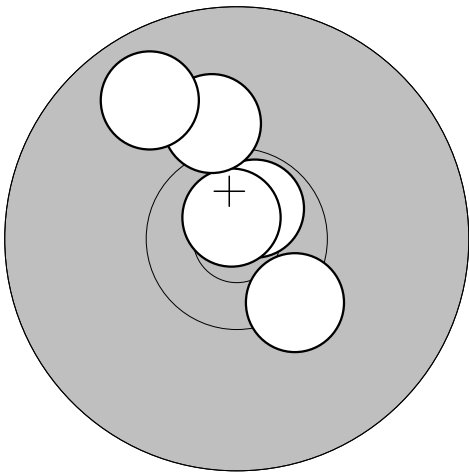
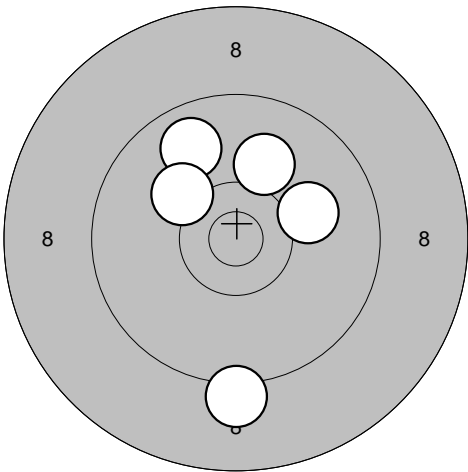
<p>Tävlingsskott</p> 	<p>1: 10,7* ↗ 2: 10,3* ↘ 3: 10,8* ↗ 4: 10,1 ↗ 5: 9,8 ↗</p> <p>Serie 49,0 Totalt 49,0</p>	<p>Tävlingsskott</p> 	<p>6: 10,0 ↗ 7: 9,8 ↗ 8: 10,1 → 9: 9,1 ↓ 10: 10,2 ↗</p> <p>Serie 48,0 Totalt 97,0</p>
--	--	--	---

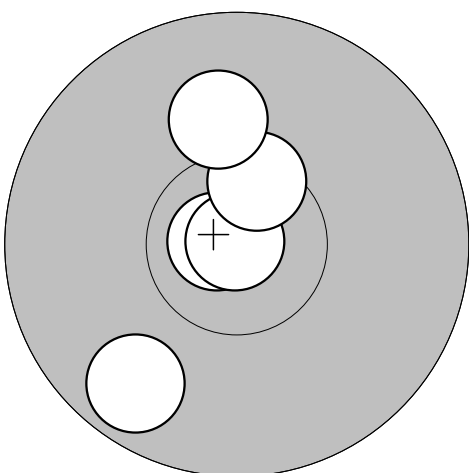
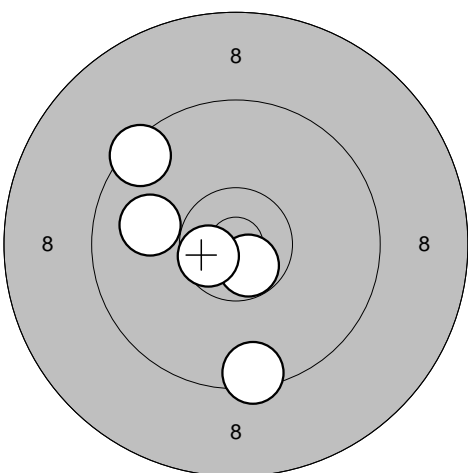
<p>Tävlingsskott</p> 	<p>11: 10,8* ← 12: 10,9* ↗ 13: 9,7 ↙ 14: 10,5* ↗ 15: 10,1 ↗</p> <p>Serie 49,0 Totalt 146,0</p>	<p>Tävlingsskott</p> 	<p>16: 9,9 ← 17: 10,7* ↘ 18: 10,6* ← 19: 9,5 ↓ 20: 9,5 ↗</p> <p>Serie 47,0 Totalt 193,0</p>
---	--	---	---

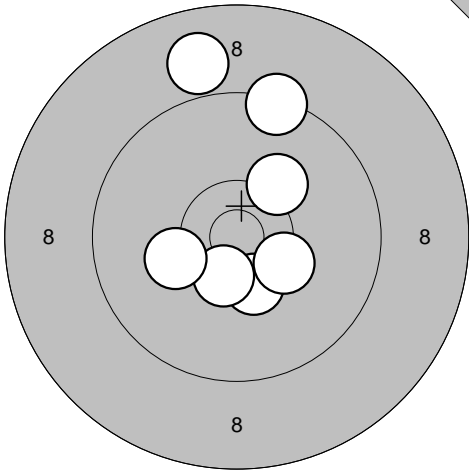
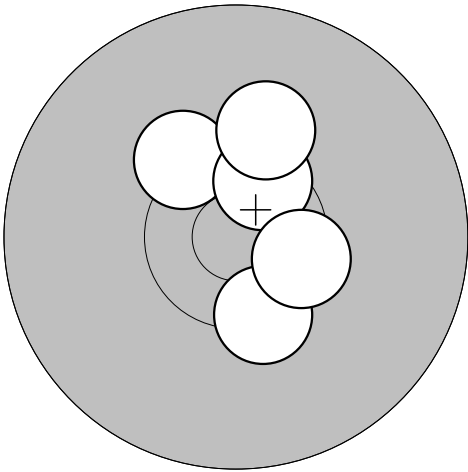
<p>Provskott</p> 	<p>Tävlingsskott</p> 	
<p>1: 8,9 ↗ 2: 10,4* ↓ 3: 9,4 ↗ 4: 10,2 ↗ 5: 10,3* → 6: 10,5* ↓ 7: 10,2 ←</p>	<p>1: 10,4* ↓ 2: 10,3* ↗ 3: 10,5* ↗ 4: 10,2 ↗ 5: 10,5* →</p>	
Serie 67,0	Serie 50,0	
Totalt 0,0	Totalt 50,0	

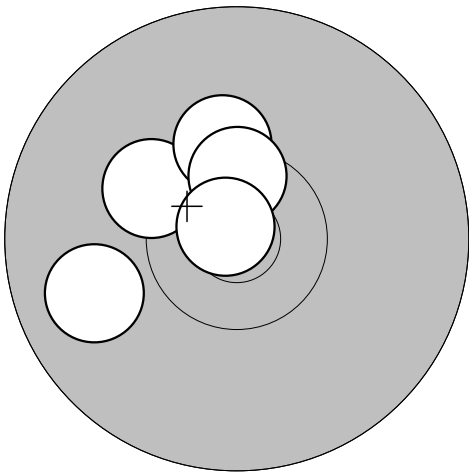
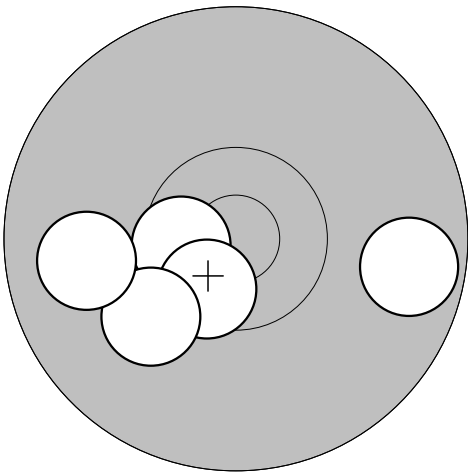
<p>Tävlingsskott</p> 	<p>Tävlingsskott</p> 	
<p>6: 10,3 ↗ 7: 9,9 ← 8: 10,3 ↗ 9: 10,5* ↗ 10: 10,8* ↗</p>	<p>11: 10,6* ← 12: 10,5* ↓ 13: 9,7 → 14: 10,1 ↗ 15: 9,9 ←</p>	
Serie 49,0	Serie 48,0	
Totalt 99,0	Totalt 147,0	

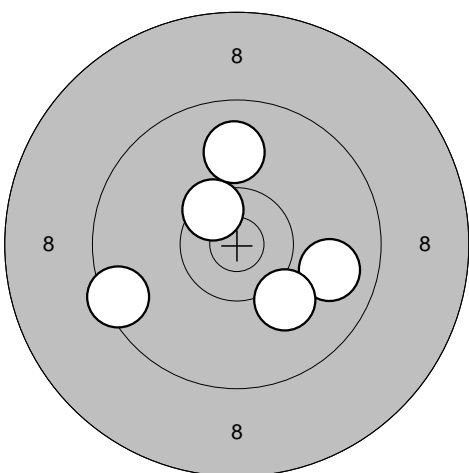
<p>Tävlingsskott</p> 	<p>16: 10,5* ↗ 17: 9,8 → 18: 9,9 ↗ 19: 9,5 ← 20: 10,1 ↓</p>	
Serie 47,0		
Totalt 194,0		

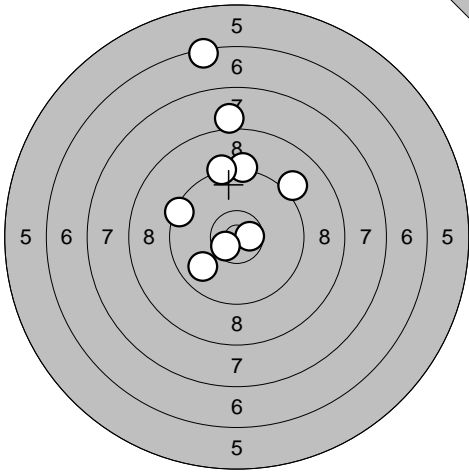
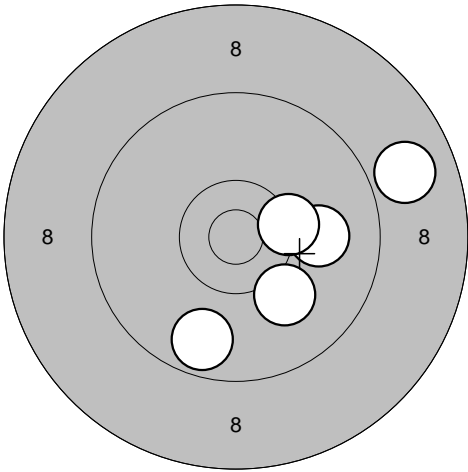
<p>Provs-kott</p> 	<p>Tävlingsskott</p> 	<p>1: 6,4    ↗</p> <p>2: 8,1    ↗</p> <p>3: 9,3    ↗</p> <p>4: 9,4    ↖</p> <p>5: 9,3    ↗</p> <p>6: 9,8    ↖</p> <p>7: 9,1    ↗</p> <p>8: 10,6* →</p> <p>9: 10,6* ↖</p>
Serie    79,0	Serie    47,0	
Totalt    0,0	Totalt    47,0	

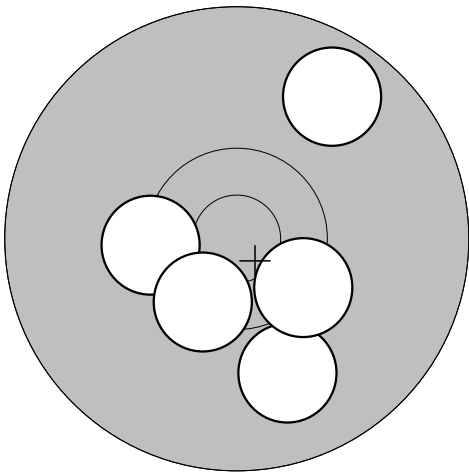
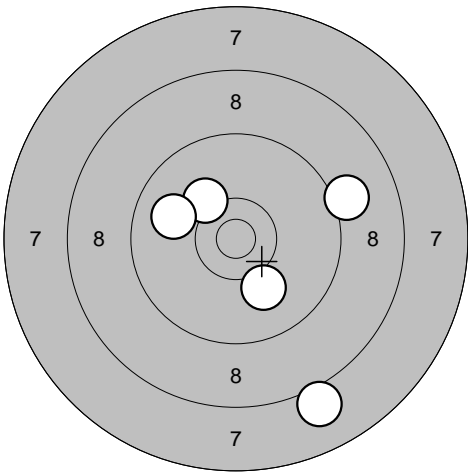
<p>Tävlingsskott</p> 	<p>Tävlingsskott</p> 	<p>6: 9,7    ↗</p> <p>7: 10,3* ←</p> <p>8: 9,9    ↘</p> <p>9: 10,4* ↘</p> <p>10: 10,4* ↘</p>
Serie    48,0	Serie    46,0	
Totalt    95,0	Totalt    141,0	

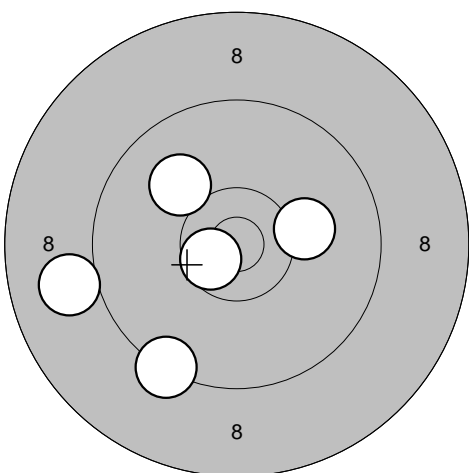
<p>Tävlingsskott</p> 	<p>16: 9,3    ↘</p> <p>17: 9,0    ←</p> <p>18: 10,0    ↗</p> <p>19: 10,2    →</p> <p>20: 10,6* ↖</p>	
Serie    48,0		
Totalt    189,0		

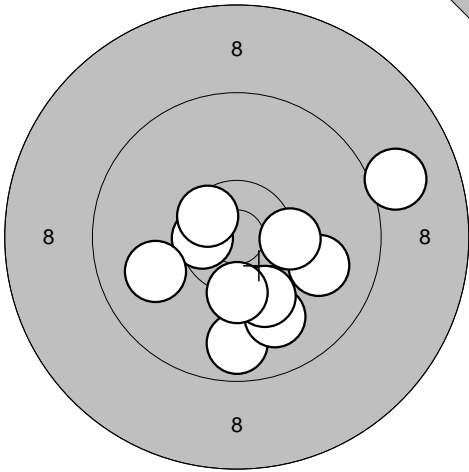
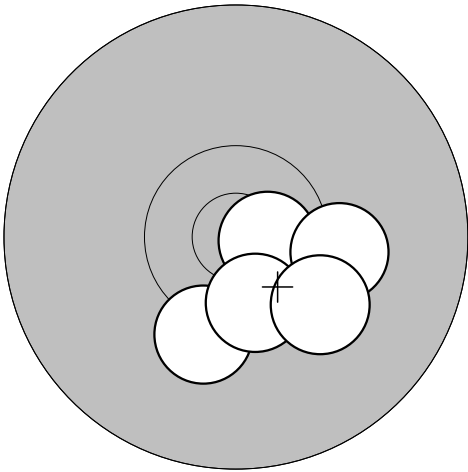
<p>Provskott</p> 	<p>Tävlingsskott</p> 	<table style="width:100%; border-collapse: collapse;"> <tr><td>1: 9,0</td><td>→</td><td>1: 10,2</td><td>↓</td></tr> <tr><td>2: 9,7</td><td>↓</td><td>2: 10,7*</td><td>→</td></tr> <tr><td>3: 9,9</td><td>↓</td><td>3: 10,2</td><td>→</td></tr> <tr><td>4: 10,0</td><td>→</td><td>4: 10,5*</td><td>↓</td></tr> <tr><td>5: 10,2</td><td>↓</td><td>5: 10,2</td><td>↓</td></tr> <tr><td>6: 10,6*</td><td>←</td><td></td><td></td></tr> <tr><td>7: 9,9</td><td>←</td><td></td><td></td></tr> <tr><td>8: 10,5*</td><td>↗</td><td></td><td></td></tr> <tr><td>9: 10,3*</td><td>↓</td><td></td><td></td></tr> <tr><td>10: 10,3*</td><td>→</td><td></td><td></td></tr> <tr><td colspan="2">Serie 96,0</td><td colspan="2">Serie 50,0</td></tr> <tr><td colspan="2">Totalt 0,0</td><td colspan="2">Totalt 50,0</td></tr> </table>	1: 9,0	→	1: 10,2	↓	2: 9,7	↓	2: 10,7*	→	3: 9,9	↓	3: 10,2	→	4: 10,0	→	4: 10,5*	↓	5: 10,2	↓	5: 10,2	↓	6: 10,6*	←			7: 9,9	←			8: 10,5*	↗			9: 10,3*	↓			10: 10,3*	→			Serie 96,0		Serie 50,0		Totalt 0,0		Totalt 50,0	
1: 9,0	→	1: 10,2	↓																																															
2: 9,7	↓	2: 10,7*	→																																															
3: 9,9	↓	3: 10,2	→																																															
4: 10,0	→	4: 10,5*	↓																																															
5: 10,2	↓	5: 10,2	↓																																															
6: 10,6*	←																																																	
7: 9,9	←																																																	
8: 10,5*	↗																																																	
9: 10,3*	↓																																																	
10: 10,3*	→																																																	
Serie 96,0		Serie 50,0																																																
Totalt 0,0		Totalt 50,0																																																

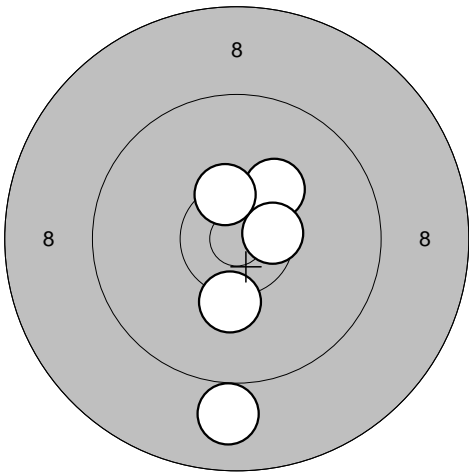
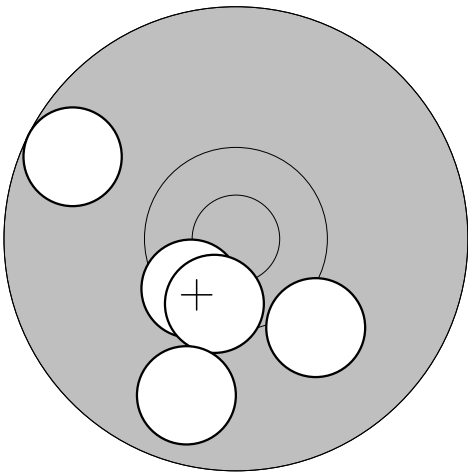
<p>Tävlingsskott</p> 	<p>Tävlingsskott</p> 	<table style="width:100%; border-collapse: collapse;"> <tr><td>6: 10,2</td><td>↓</td><td>11: 10,5*</td><td>↙</td></tr> <tr><td>7: 10,2</td><td>↗</td><td>12: 10,5*</td><td>↓</td></tr> <tr><td>8: 10,5*</td><td>→</td><td>13: 10,1</td><td>↘</td></tr> <tr><td>9: 10,4*</td><td>↑</td><td>14: 9,8</td><td>↓</td></tr> <tr><td>10: 8,9</td><td>↓</td><td>15: 9,7</td><td>↙</td></tr> <tr><td colspan="2">Serie 48,0</td><td colspan="2">Serie 48,0</td></tr> <tr><td colspan="2">Totalt 98,0</td><td colspan="2">Totalt 146,0</td></tr> </table>	6: 10,2	↓	11: 10,5*	↙	7: 10,2	↗	12: 10,5*	↓	8: 10,5*	→	13: 10,1	↘	9: 10,4*	↑	14: 9,8	↓	10: 8,9	↓	15: 9,7	↙	Serie 48,0		Serie 48,0		Totalt 98,0		Totalt 146,0	
6: 10,2	↓	11: 10,5*	↙																											
7: 10,2	↗	12: 10,5*	↓																											
8: 10,5*	→	13: 10,1	↘																											
9: 10,4*	↑	14: 9,8	↓																											
10: 8,9	↓	15: 9,7	↙																											
Serie 48,0		Serie 48,0																												
Totalt 98,0		Totalt 146,0																												

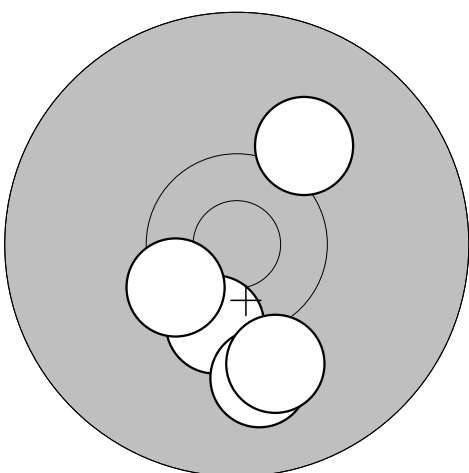
<p>Tävlingsskott</p> 	<table style="width:100%; border-collapse: collapse;"> <tr><td>16: 10,1</td><td>↗</td></tr> <tr><td>17: 10,4*</td><td>↓</td></tr> <tr><td>18: 10,0</td><td>↓</td></tr> <tr><td>19: 10,4*</td><td>↙</td></tr> <tr><td>20: 10,1</td><td>↓</td></tr> <tr><td colspan="2">Serie 50,0</td></tr> <tr><td colspan="2">Totalt 196,0</td></tr> </table>	16: 10,1	↗	17: 10,4*	↓	18: 10,0	↓	19: 10,4*	↙	20: 10,1	↓	Serie 50,0		Totalt 196,0	
16: 10,1	↗														
17: 10,4*	↓														
18: 10,0	↓														
19: 10,4*	↙														
20: 10,1	↓														
Serie 50,0															
Totalt 196,0															

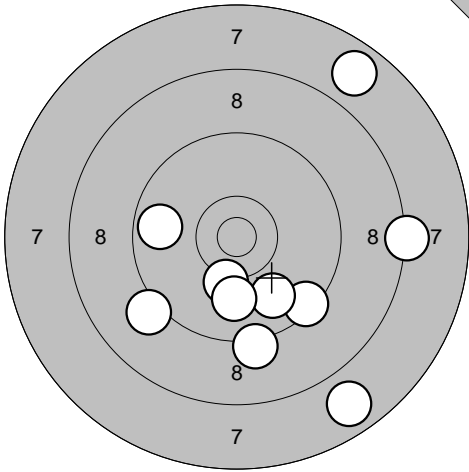
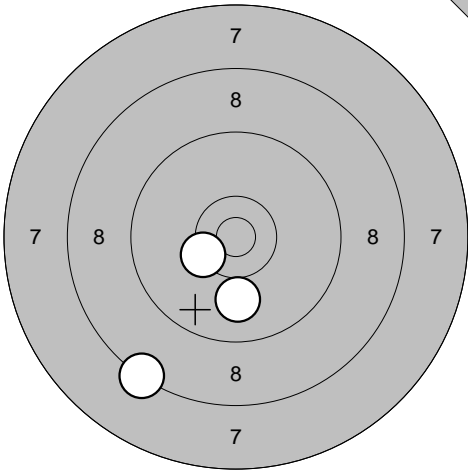
<p>Provs-kott</p> 	<p>1: 7,8 ↘ 2: 8,3 → 3: 7,8 ↗ 4: 9,4 ↘ 5: 9,2 ↘ 6: 9,9 ↘ 7: 10,2 ↘ 8: 9,7 ← 9: 9,1 ↙ 10: 10,0 ↓</p>	<p>Provs-kott</p> 	<p>11: 10,0 ↓ 12: 10,4* ↙ 13: 8,3 ↘</p>
Serie 87,0	Serie 28,0	Serie 28,0	Serie 28,0
Totalt 0,0	Totalt 0,0	Totalt 0,0	Totalt 0,0

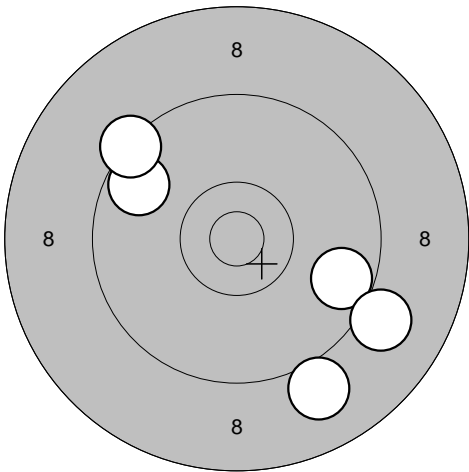
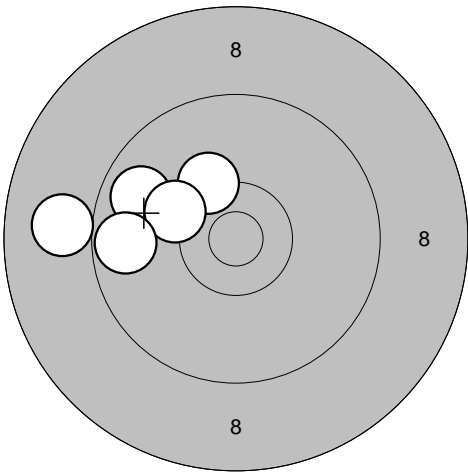
<p>Tävlingsskott</p> 	<p>1: 9,7 ↗ 2: 9,4 ↗ 3: 9,0 ↘ 4: 9,7 → 5: 9,1 ↘</p>	<p>Tävlingsskott</p> 	<p>6: 10,2 ↗ 7: 9,8 ↙ 8: 10,2 ↙ 9: 9,0 ← 10: 9,7 ←</p>
Serie 45,0	Serie 47,0	Serie 47,0	Serie 47,0
Totalt 45,0	Totalt 92,0	Totalt 92,0	Totalt 92,0

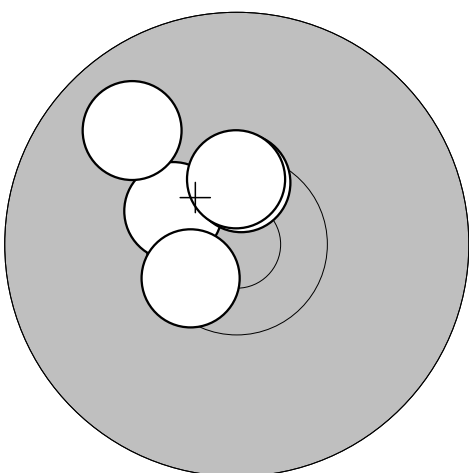
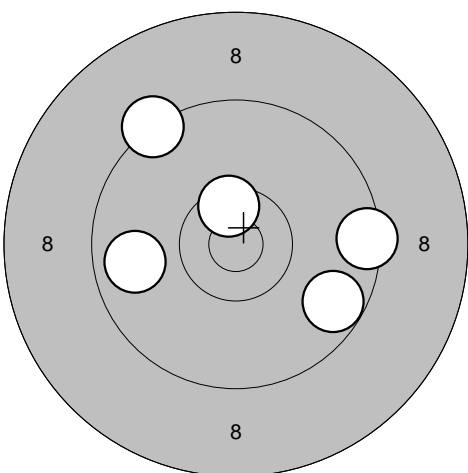
<p>Tävlingsskott</p> 	<p>11: 10,4* ↙ 12: 10,5* ↙ 13: 10,5* ↑ 14: 10,5* ↑ 15: 9,9 ↗</p>	<p>Tävlingsskott</p> 	<p>16: 9,4 → 17: 9,8 ← 18: 10,5* ↑ 19: 9,3 ↗ 20: 9,7 ↘</p>
Serie 49,0	Serie 46,0	Serie 46,0	Serie 46,0
Totalt 141,0	Totalt 187,0	Totalt 187,0	Totalt 187,0



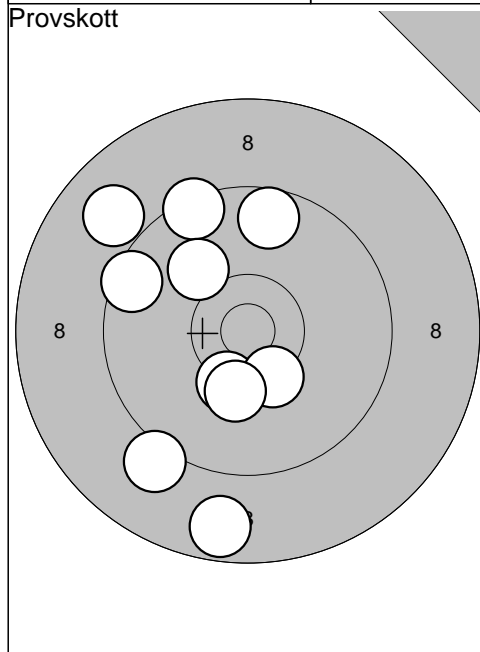

1: 9,5	↖
2: 8,7	↓
3: 9,1	↙
4: 9,4	↗
5: 10,3*	↙
6: 10,1	↗
7: 10,4*	↙
8: 10,2	↓
9: 9,6	↗
10: 8,9	↗
<hr/>	
Serie	92,0
<hr/>	
Totalt	0,0

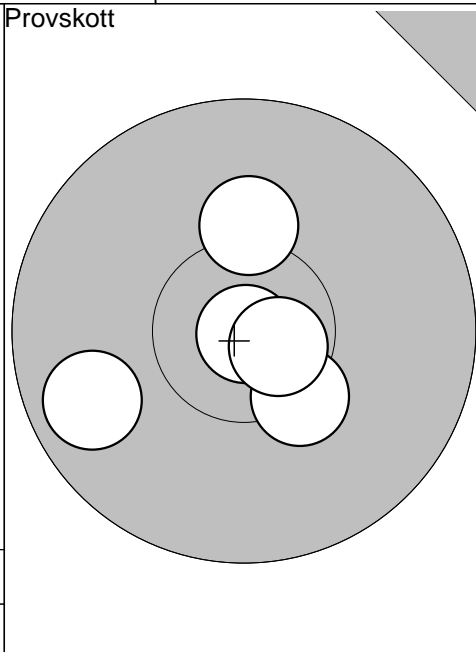

11: 10,3*	↘
12: 10,2	↑
13: 10,9*	↘
14: 10,7*	↘
15: 9,8	↖
<hr/>	
Serie	49,0
<hr/>	
Totalt	0,0

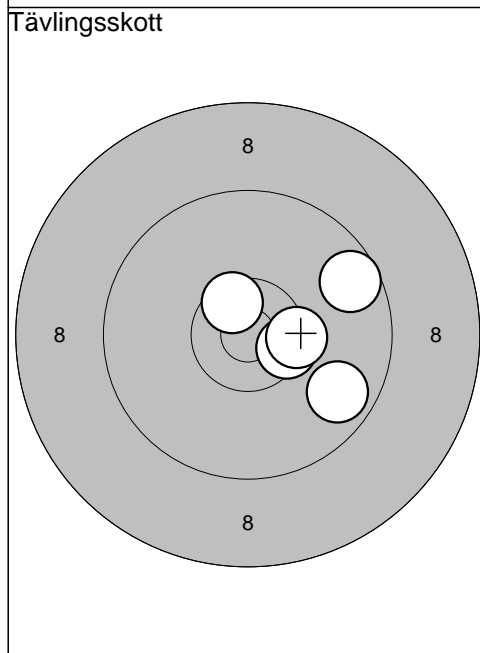

1: 10,6*	↗
2: 10,5*	↘
3: 10,4*	→
4: 9,6	↗
5: 9,7	↘
<hr/>	
Serie	48,0
<hr/>	
Totalt	48,0

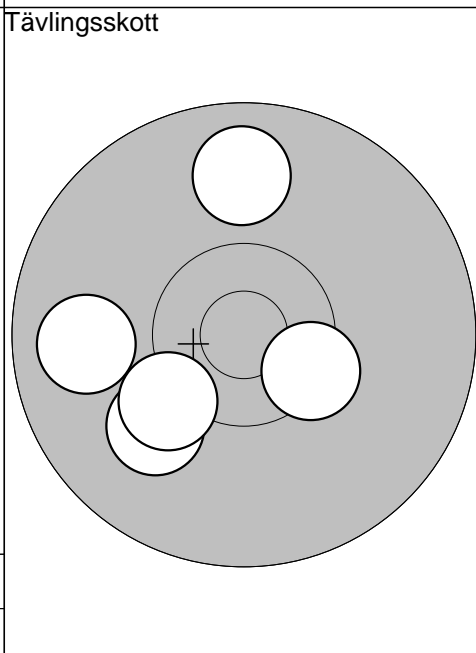

6: 10,4*	↘
7: 10,0	↙
8: 10,2	↙
9: 9,8	←
10: 9,8	↑
<hr/>	
Serie	48,0
<hr/>	
Totalt	96,0

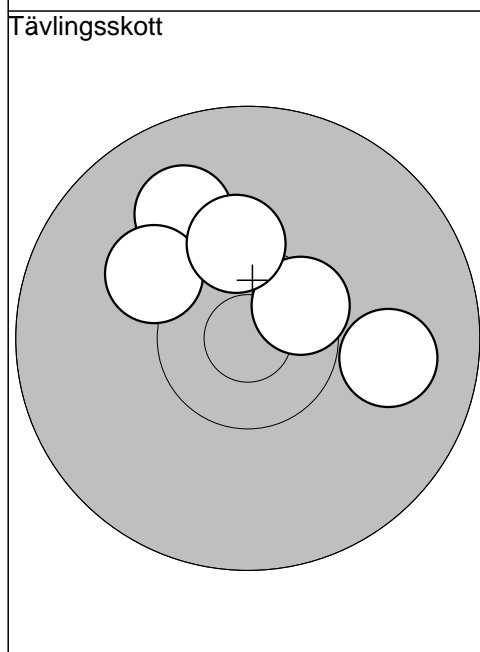

11: 10,5*	↗
12: 10,0	↗
13: 10,1	↗
14: 9,9	→
15: 10,3	↑
<hr/>	
Serie	49,0
<hr/>	
Totalt	145,0

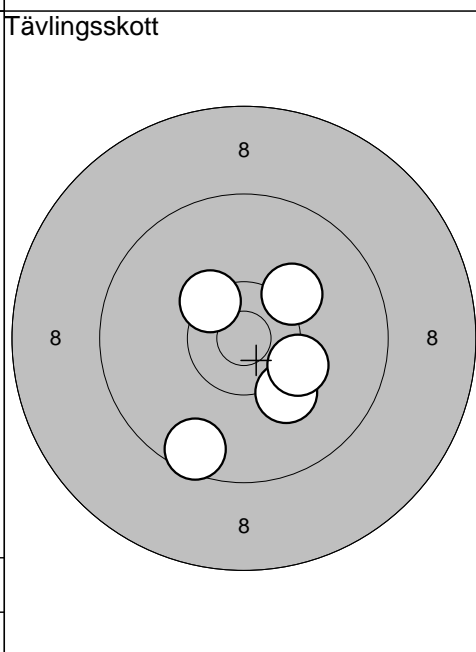

16: 10,2	↘
17: 9,6	↘
18: 10,3	↘
19: 10,2	↗
20: 10,4*	↖
<hr/>	
Serie	49,0
<hr/>	
Totalt	194,0

Drängsmark

2009-07-16

Tavelträffen 2009

Ramselefors SKF

Provs-kott

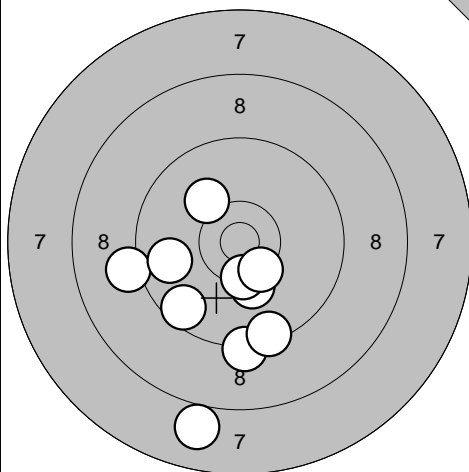

- 1: 10,1 ↗
- 2: 9,6 ↘
- 3: 9,1 ←
- 4: 9,8 ←
- 5: 9,3 ↓
- 6: 10,2 ↓
- 7: 9,4 ↓
- 8: 8,0 ↓
- 9: 10,4\* ↓
- 10: 10,4\* ↓

Serie 93,0

Totalt 0,0

Provs-kott

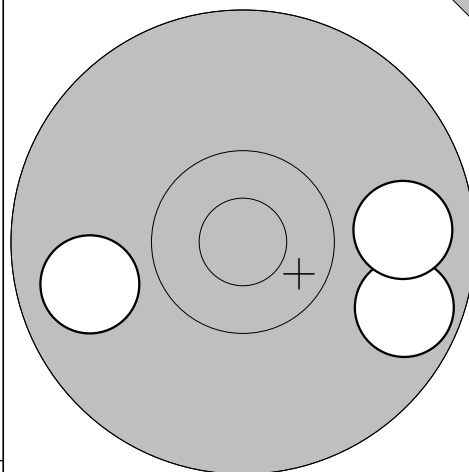

- 11: 9,7 →
- 12: 9,8 →
- 13: 9,8 ←

Serie 27,0

Totalt 0,0

Tävlingsskott

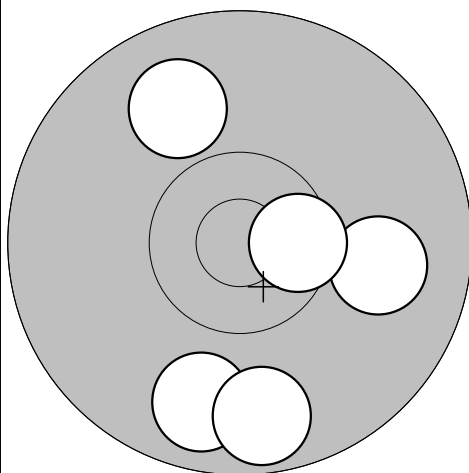

- 1: 9,8 ↓
- 2: 9,9 ↗
- 3: 9,9 →
- 4: 10,5\* →
- 5: 9,7 ↓

Serie 46,0

Totalt 46,0

Tävlingsskott

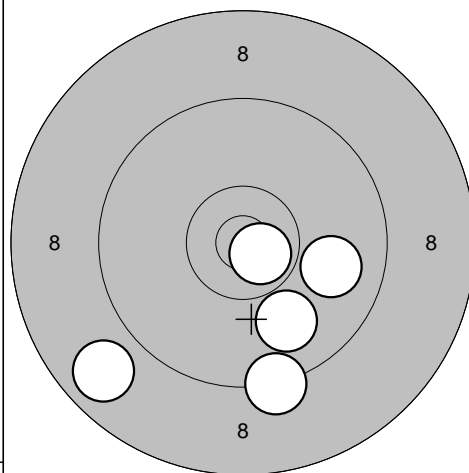

- 6: 9,3 ↓
- 7: 9,9 ↓
- 8: 8,8 ↙
- 9: 10,7\* ↘
- 10: 9,9 →

Serie 45,0

Totalt 91,0

Tävlingsskott

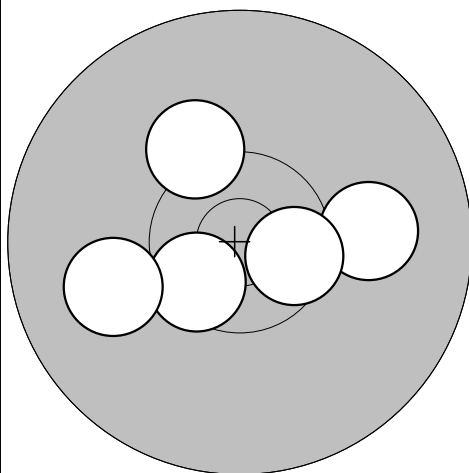

- 11: 10,5\* ↘
- 12: 10,0 ←
- 13: 10,0 →
- 14: 10,5\* →
- 15: 10,2 ↗

Serie 50,0

Totalt 141,0

Tävlingsskott

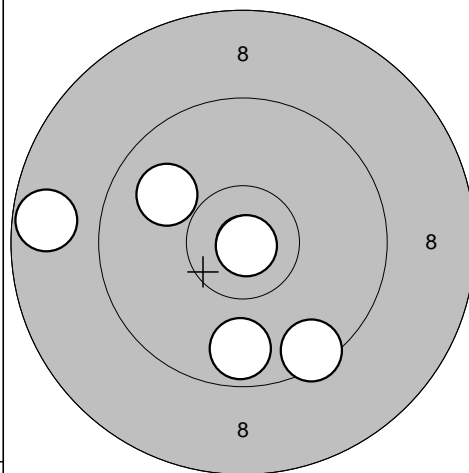

- 16: 9,5 ↓
- 17: 8,7 ←
- 18: 9,9 ↗
- 19: 9,7 ↓
- 20: 10,9\* ↘

Serie 45,0

Totalt 186,0

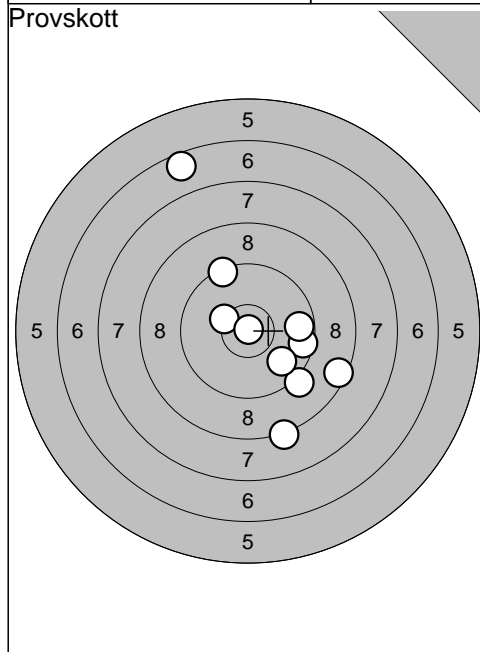

1: 6,6	↖
2: 8,5	↘
3: 9,2	↙
4: 8,3	↘
5: 10,3*	↖
6: 9,6	↘
7: 9,7	→
8: 9,8	↘
9: 9,4	↖
10: 10,9*	↗
Serie	87,0
Totalt	0,0

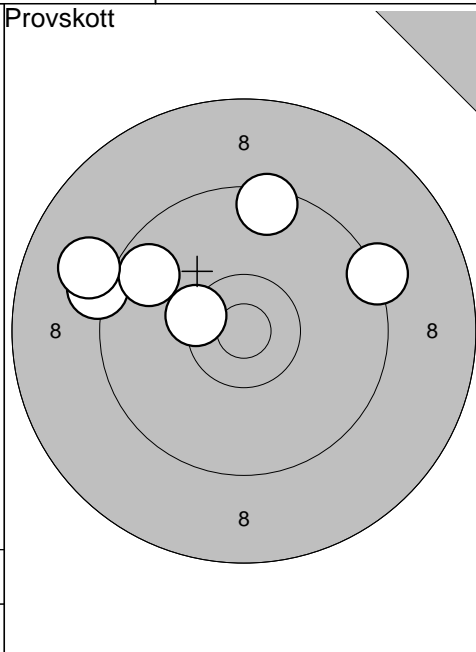

11: 9,2	↖
12: 9,3	↗
13: 10,4*	↖
14: 9,7	↖
15: 9,5	↖
16: 9,0	↖
Serie	55,0
Totalt	0,0

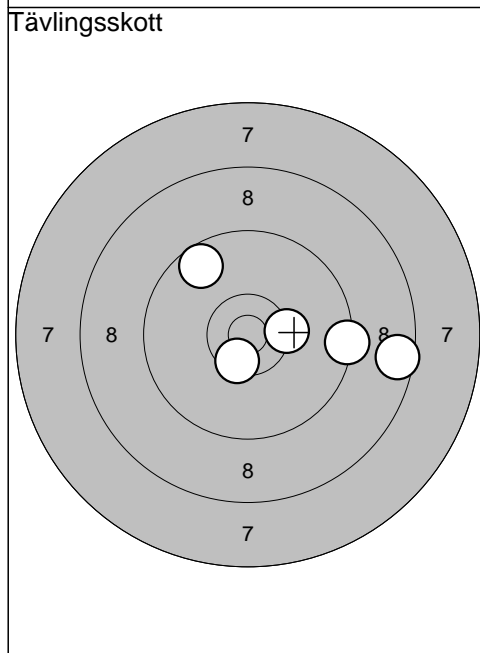

1: 9,4	→
2: 9,6	↖
3: 10,3*	→
4: 8,6	→
5: 10,5*	↘
Serie	46,0
Totalt	46,0

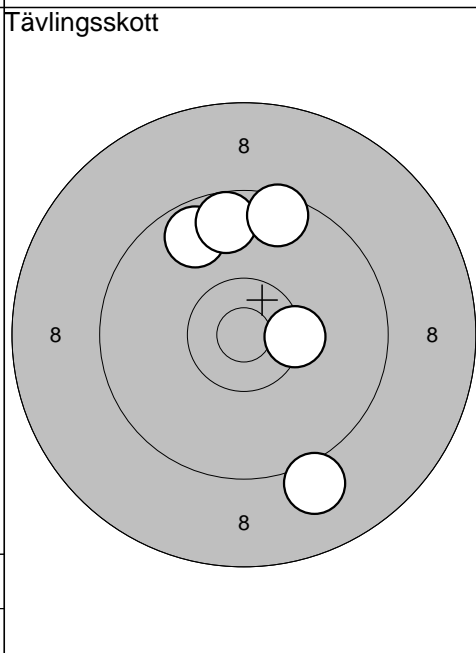

6: 10,4*	→
7: 9,7	↖
8: 9,7	↖
9: 9,1	↘
10: 9,5	↖
Serie	46,0
Totalt	92,0

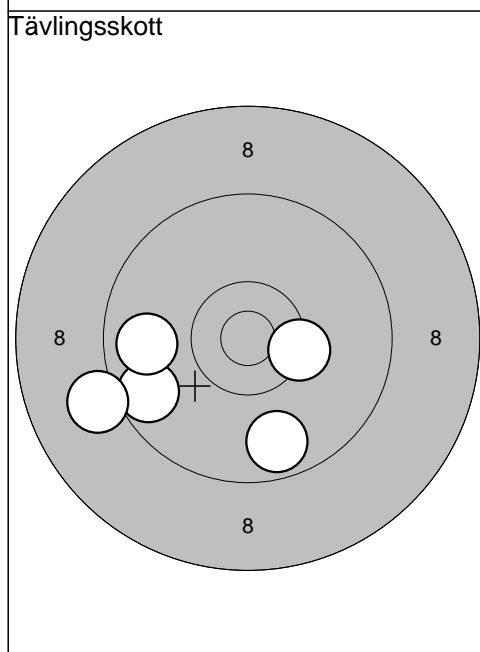

11: 9,7	↘
12: 9,7	↖
13: 10,3*	→
14: 9,8	↖
15: 9,1	↖
Serie	46,0
Totalt	138,0

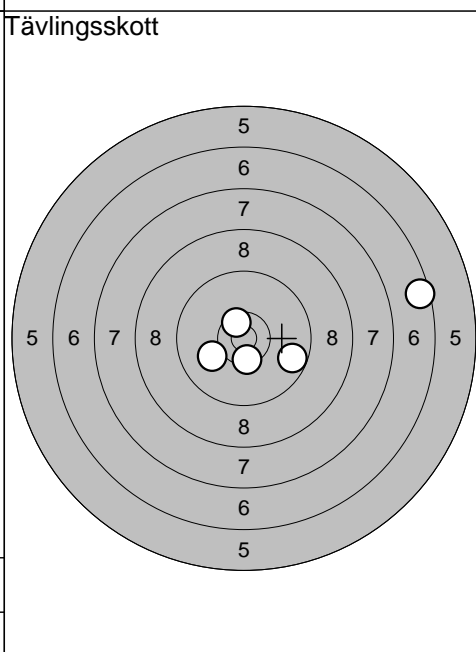

16: 10,5*	↖
17: 6,5	→
18: 9,7	↘
19: 10,4*	↘
20: 10,1	↖
Serie	45,0
Totalt	183,0

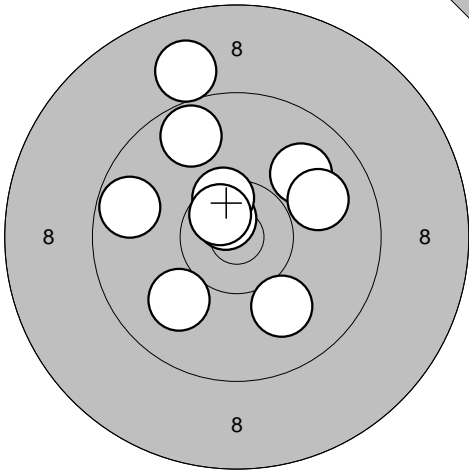
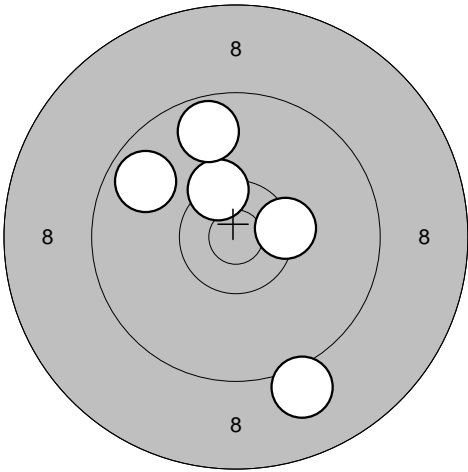
<p>Provsnitt</p> 	<p>Tävlingssnitt</p> 	
<p>1: 9,7 ↗ 2: 10,7* ↗ 3: 9,7 ← 4: 9,0 ↗ 5: 10,5* ↗ 6: 10,6* ↗ 7: 9,9 ↗ 8: 9,9 → 9: 10,0 ↓ 10: 10,0 ↘</p>	<p>1: 10,4* ↗ 2: 9,1 ↓ 3: 10,4* → 4: 9,7 ↗ 5: 9,7 ↖</p>	
Serie 95,0	Serie 47,0	
Totalt 0,0	Totalt 47,0	

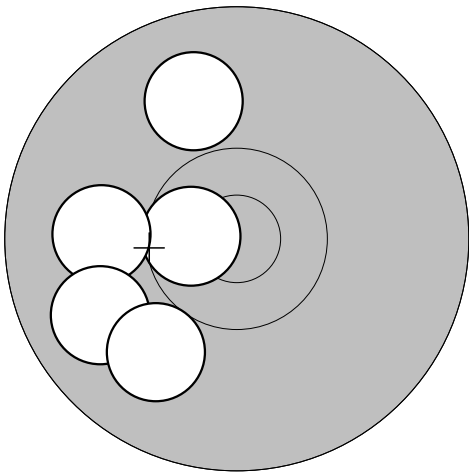
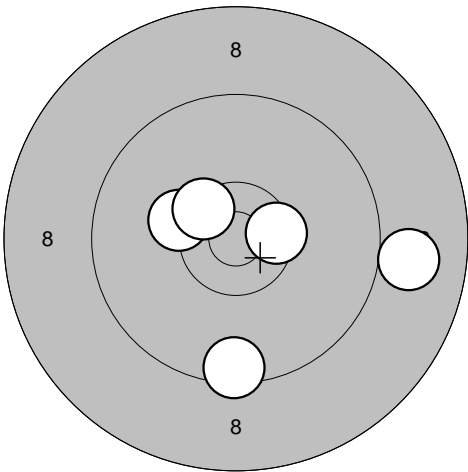
<p>Tävlingssnitt</p> 	<p>Tävlingssnitt</p> 	
<p>6: 9,9 ↗ 7: 10,6* ← 8: 10,0 ← 9: 9,8 ← 10: 10,0 ↘</p>	<p>11: 9,0 → 12: 10,5* → 13: 9,5 ↓ 14: 10,3 ← 15: 10,5* ↗</p>	
Serie 48,0	Serie 48,0	
Totalt 95,0	Totalt 143,0	

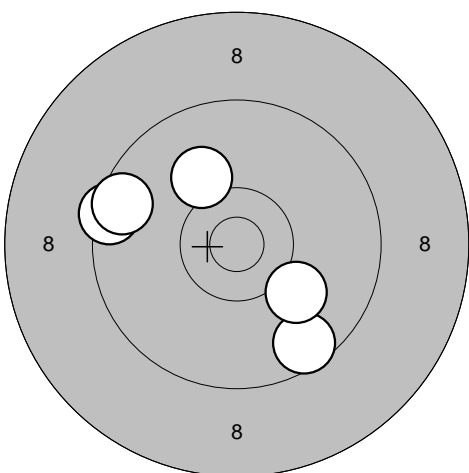
<p>Tävlingssnitt</p> 		
<p>16: 9,6 ↓ 17: 9,5 ← 18: 10,1 ↗ 19: 10,1 ↓ 20: 9,6 ↖</p>		
Serie 47,0		
Totalt 190,0		

Provskott

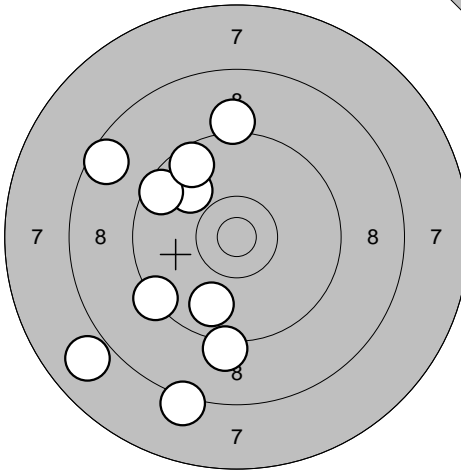

Target diagram showing 10 shots clustered in the center, mostly within the 8 and 9 rings.

1: 9,9	↗
2: 8,6	↗
3: 9,6	↗
4: 9,6	↗
5: 9,1	↑
6: 9,2	↓
7: 7,9	↙
8: 9,4	↙
9: 8,2	↓
10: 9,8	↓
<hr/>	
Serie	86,0
Totalt	0,0

Provskott

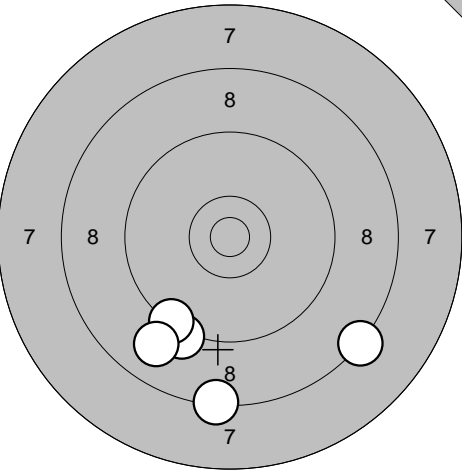

Target diagram showing 5 shots clustered in the center, mostly within the 8 and 9 rings.

11: 9,2	↓
12: 8,3	↘
13: 8,3	↓
14: 9,3	↙
15: 8,9	↙
<hr/>	
Serie	42,0
Totalt	0,0

Tävlingsskott

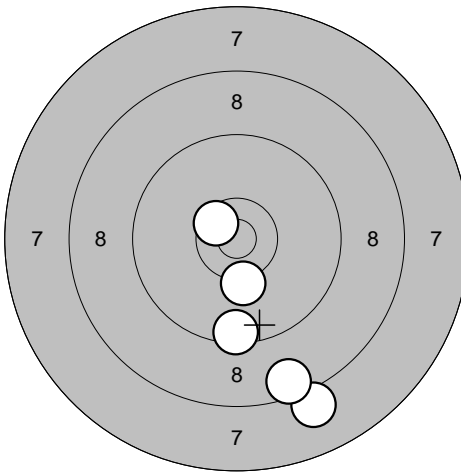

Target diagram showing 5 shots clustered in the center, mostly within the 8 and 9 rings.

1: 8,1	↓
2: 9,5	↓
3: 10,2	↓
4: 8,6	↘
5: 10,5*	↗
<hr/>	
Serie	45,0
Totalt	45,0

Tävlingsskott

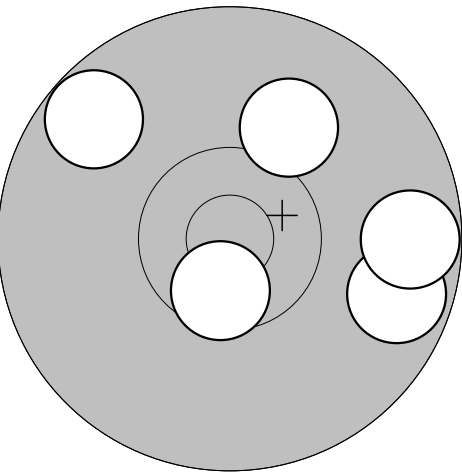

Target diagram showing 5 shots scattered across the target, mostly in the 7 and 8 rings.

6: 9,7	↖
7: 10,6*	↓
8: 10,1	↗
9: 9,7	↘
10: 9,7	→
<hr/>	
Serie	47,0
Totalt	92,0

Tävlingsskott

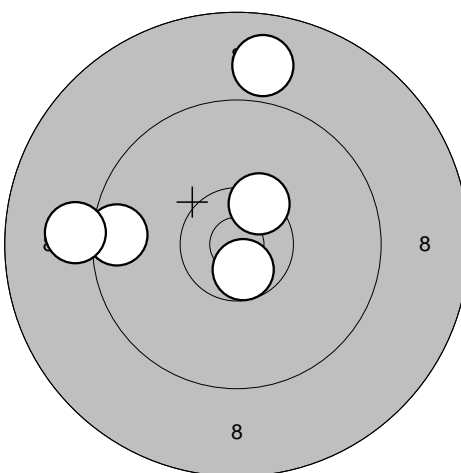

Target diagram showing 5 shots scattered across the target, mostly in the 8 and 9 rings.

11: 9,6	←
12: 9,1	←
13: 10,6*	↓
14: 8,9	↑
15: 10,4*	↗
<hr/>	
Serie	46,0
Totalt	138,0

Tävlingsskott

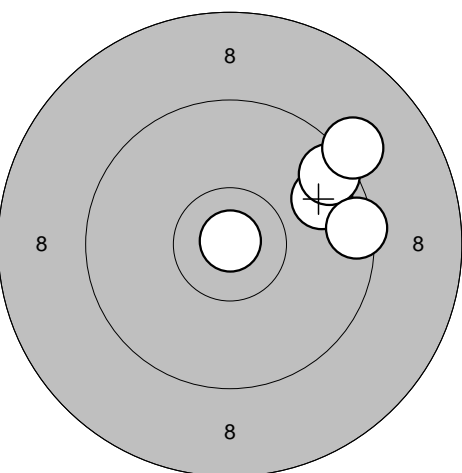

Target diagram showing 5 shots clustered in the center, mostly within the 8 and 9 rings.

16: 9,8	↗
17: 9,6	↗
18: 9,2	↗
19: 9,5	→
20: 10,9*	↗
<hr/>	
Serie	46,0
Totalt	184,0

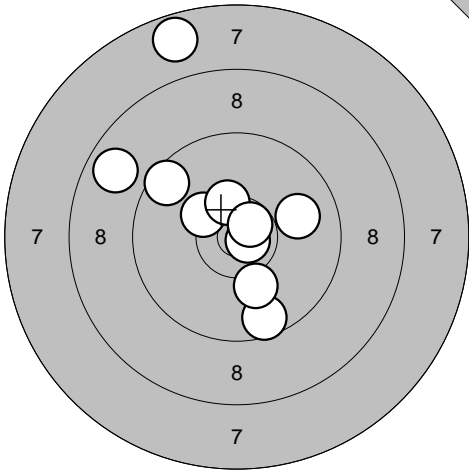
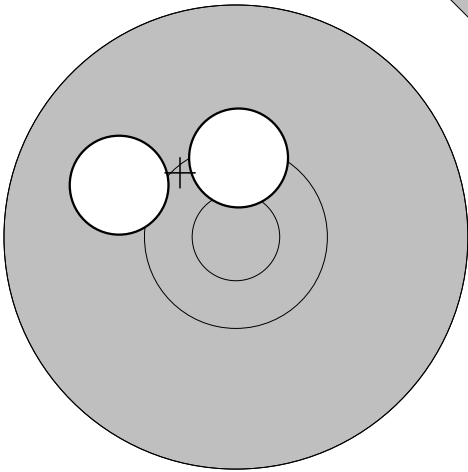
<p>Provskott</p> 	<p>1: 10,8* ↘ 2: 10,3* ↗ 3: 9,6 ↘ 4: 9,6 ↗ 5: 8,8 ↗ 6: 10,1 ↘ 7: 9,9 → 8: 7,7 ↗ 9: 10,4* ↗ 10: 10,7* ↗</p> <table border="1" style="width:100%; border-collapse: collapse;"> <tr><td>Serie</td><td style="text-align: right;">92,0</td></tr> <tr><td>Totalt</td><td style="text-align: right;">0,0</td></tr> </table>	Serie	92,0	Totalt	0,0	<p>Provskott</p>  <p>11: 10,4* ↑ 12: 10,0 ↖</p> <table border="1" style="width:100%; border-collapse: collapse;"> <tr><td>Serie</td><td style="text-align: right;">20,0</td></tr> <tr><td>Totalt</td><td style="text-align: right;">0,0</td></tr> </table>	Serie	20,0	Totalt	0,0
Serie	92,0									
Totalt	0,0									
Serie	20,0									
Totalt	0,0									

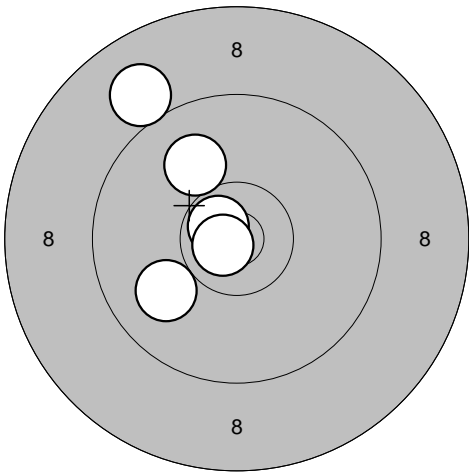
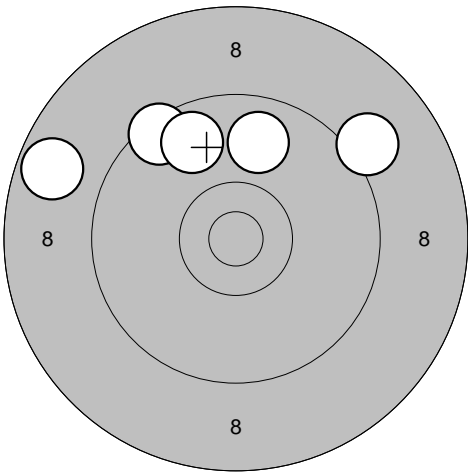
<p>Tävlingsskott</p> 	<p>1: 10,7* ↖ 2: 10,0 ↗ 3: 10,0 ↖ 4: 9,0 ↗ 5: 10,8* ↖</p> <table border="1" style="width:100%; border-collapse: collapse;"> <tr><td>Serie</td><td style="text-align: right;">49,0</td></tr> <tr><td>Totalt</td><td style="text-align: right;">49,0</td></tr> </table>	Serie	49,0	Totalt	49,0	<p>Tävlingsskott</p>  <p>6: 9,5 ↖ 7: 8,7 ↖ 8: 9,1 ↗ 9: 9,8 ↑ 10: 9,7 ↗</p> <table border="1" style="width:100%; border-collapse: collapse;"> <tr><td>Serie</td><td style="text-align: right;">44,0</td></tr> <tr><td>Totalt</td><td style="text-align: right;">93,0</td></tr> </table>	Serie	44,0	Totalt	93,0
Serie	49,0									
Totalt	49,0									
Serie	44,0									
Totalt	93,0									

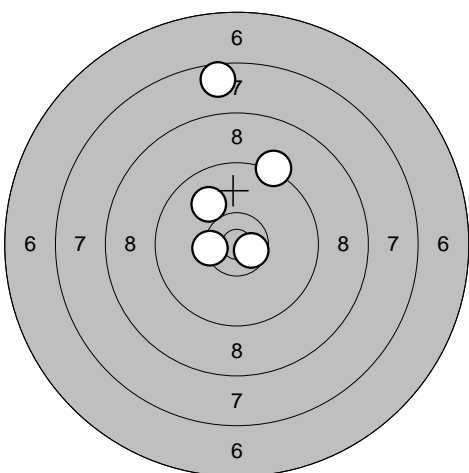
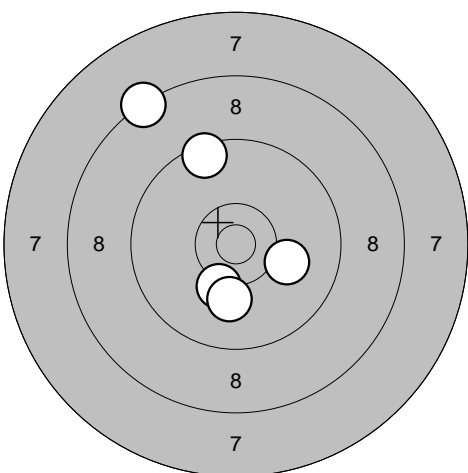
<p>Tävlingsskott</p> 	<p>11: 10,0 ↖ 12: 10,4* ← 13: 9,3 ↗ 14: 7,6 ↑ 15: 10,6* ↘</p> <table border="1" style="width:100%; border-collapse: collapse;"> <tr><td>Serie</td><td style="text-align: right;">46,0</td></tr> <tr><td>Totalt</td><td style="text-align: right;">139,0</td></tr> </table>	Serie	46,0	Totalt	139,0	<p>Tävlingsskott</p>  <p>16: 10,2 ↘ 17: 8,3 ↖ 18: 10,1 ↘ 19: 10,1 → 20: 9,5 ↗</p> <table border="1" style="width:100%; border-collapse: collapse;"> <tr><td>Serie</td><td style="text-align: right;">47,0</td></tr> <tr><td>Totalt</td><td style="text-align: right;">186,0</td></tr> </table>	Serie	47,0	Totalt	186,0
Serie	46,0									
Totalt	139,0									
Serie	47,0									
Totalt	186,0									

Ramselefors

2009-07-16

Tavelträffen 2009

Ramselefors SKF

Provs-kott

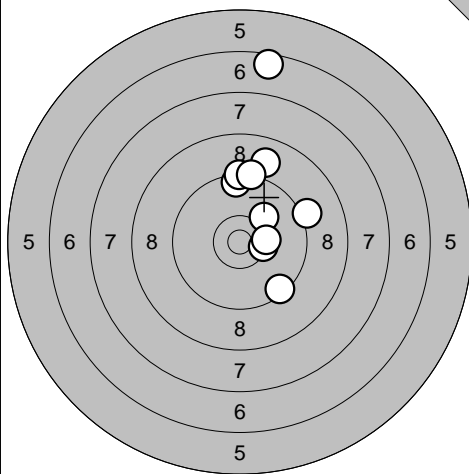

- 1: 6,6 ↗
- 2: 8,9 ↗
- 3: 10,1 ↗
- 4: 9,5 ↗
- 5: 10,4\* →
- 6: 9,2 →
- 7: 10,3\* →
- 8: 9,3 ↗
- 9: 9,3 ↗
- 10: 9,4 ↘

Serie 89,0

Totalt 0,0

Provs-kott

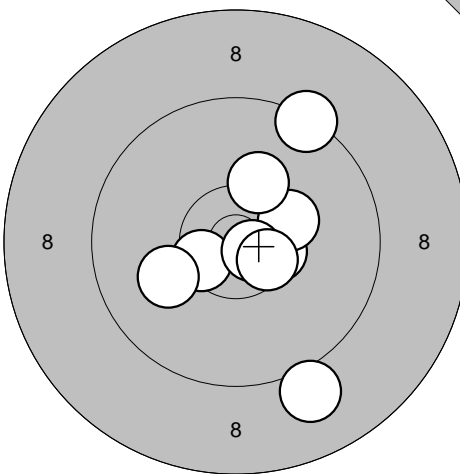

- 11: 10,5\* →
- 12: 9,0 ↘
- 13: 10,3\* →
- 14: 10,5\* ↙
- 15: 10,1 ↙
- 16: 10,7\* ↘
- 17: 10,2 ↗
- 18: 10,5\* ↘
- 19: 9,4 ↗

Serie 88,0

Totalt 0,0

Tävlingsskott

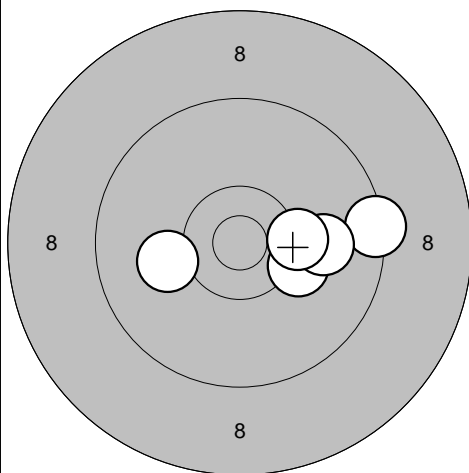

- 1: 9,4 →
- 2: 10,2 ↘
- 3: 10,1 ←
- 4: 10,0 →
- 5: 10,3 →

Serie 49,0

Totalt 49,0

Tävlingsskott

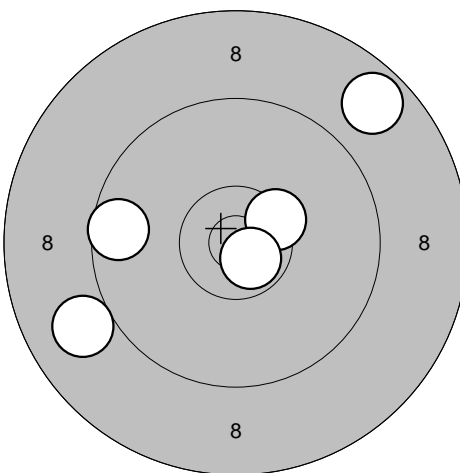

- 6: 8,7 ↗
- 7: 9,0 ↙
- 8: 10,4\* ↗
- 9: 10,7\* ↘
- 10: 9,6 ←

Serie 46,0

Totalt 95,0

Tävlingsskott

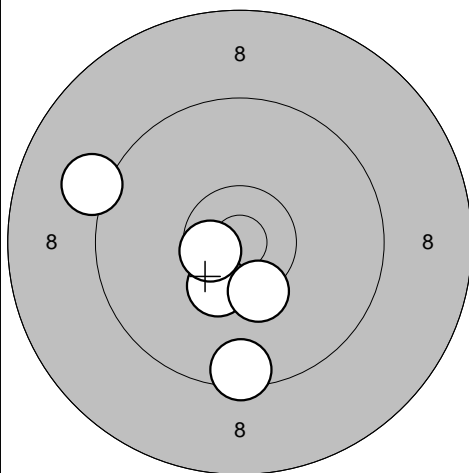

- 11: 10,4\* ↘
- 12: 10,6\* ←
- 13: 9,1 ↙
- 14: 10,3\* ↘
- 15: 9,5 ↘

Serie 48,0

Totalt 143,0

Tävlingsskott

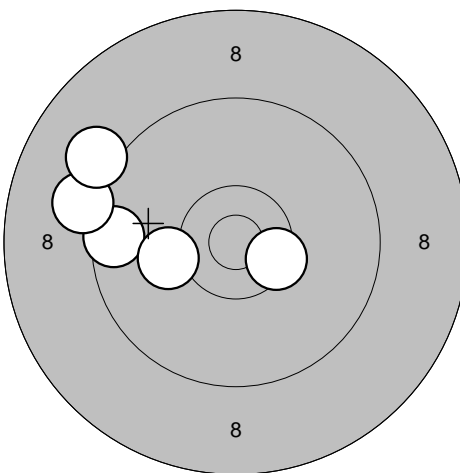

- 16: 9,6 ←
- 17: 10,4\* →
- 18: 9,2 ←
- 19: 10,2 ←
- 20: 9,1 ↙

Serie 47,0

Totalt 190,0

Rundvik

2009-07-16

Tavelträffen 2009

Ramselefors SKF

Provskott

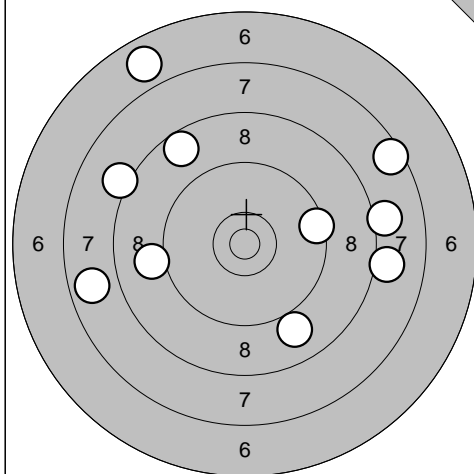

1: 6,8 ↗  
 2: 8,2 ↗  
 3: 8,7 ↗  
 4: 8,1 →  
 5: 7,8 ←  
 6: 9,1 ←  
 7: 7,5 ↗  
 8: 9,0 ↓  
 9: 8,1 →  
 10: 9,5 →

Serie 79,0

Totalt 0,0

Provskott

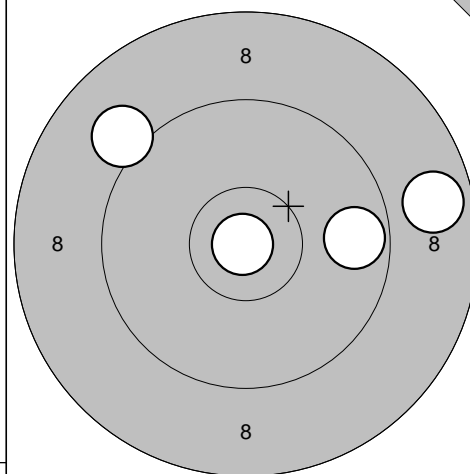

11: 8,8 →  
 12: 9,7 →  
 13: 10,9\* ←  
 14: 9,1 ↘

Serie 36,0

Totalt 0,0

Tävlingsskott

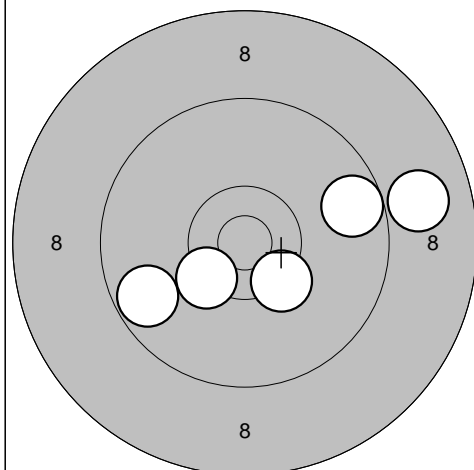

1: 10,4\* ↙  
 2: 8,9 →  
 3: 9,7 →  
 4: 10,3\* ↘  
 5: 9,7 ↙

Serie 46,0

Totalt 46,0

Tävlingsskott

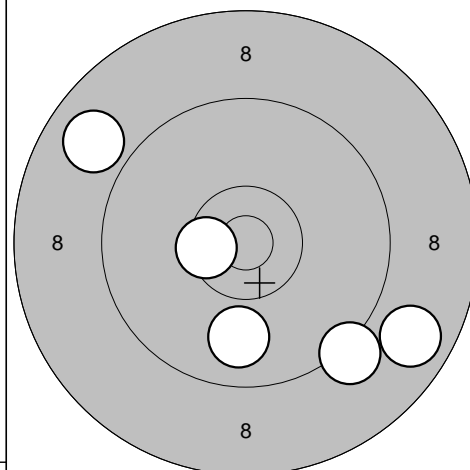

6: 9,2 ↘  
 7: 9,9 ↓  
 8: 10,5\* ←  
 9: 8,9 ↗  
 10: 8,8 ↘

Serie 44,0

Totalt 90,0

Tävlingsskott

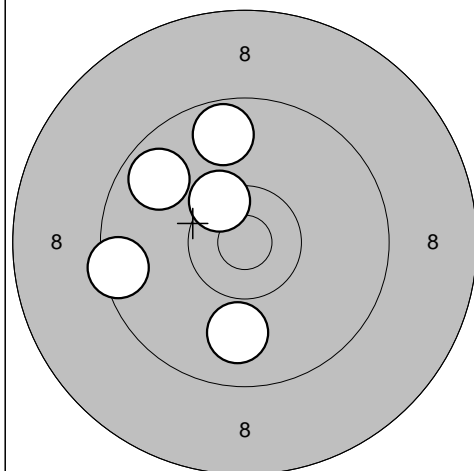

11: 9,7 ↗  
 12: 9,7 ↗  
 13: 9,5 ←  
 14: 9,9 ↓  
 15: 10,4\* ↗

Serie 46,0

Totalt 136,0

Tävlingsskott

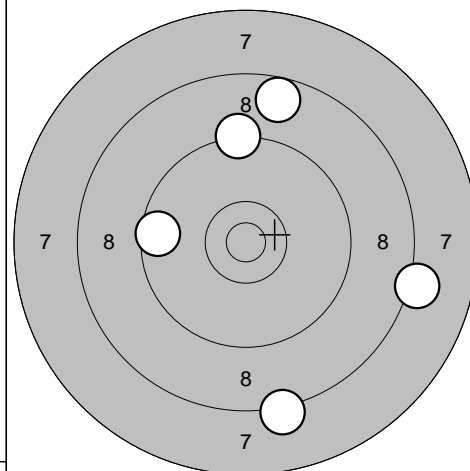

16: 9,3 ↑  
 17: 8,7 ↑  
 18: 9,6 ←  
 19: 8,2 →  
 20: 8,2 ↓

Serie 42,0

Totalt 178,0



Lindesberg

2009-07-16

Tavelträffen 2009

Ramselefors SKF

Provs-kott

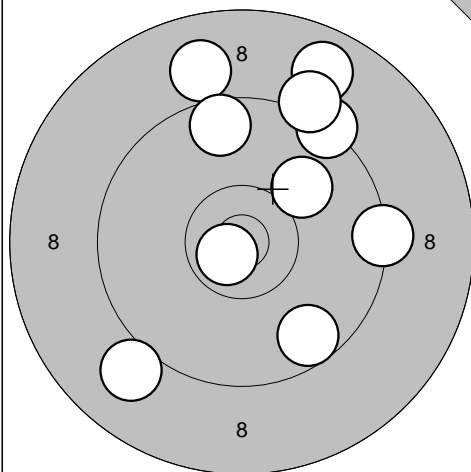

- 1: 8,8 ↗
- 2: 8,9 ↑
- 3: 9,0 ↘
- 4: 9,6 ↘
- 5: 10,7\* ↘
- 6: 9,3 ↗
- 7: 10,0 ↗
- 8: 9,2 ↗
- 9: 9,6 ↑
- 10: 9,3 →

Serie 90,0  
Totalt 0,0

Provs-kott

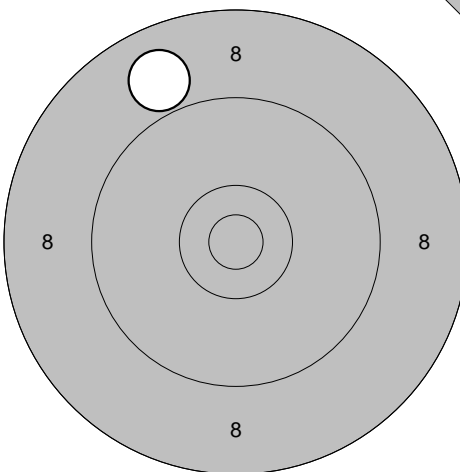

- 11: 8,9 ↗

Serie 8,0  
Totalt 0,0

Tävlingsskott

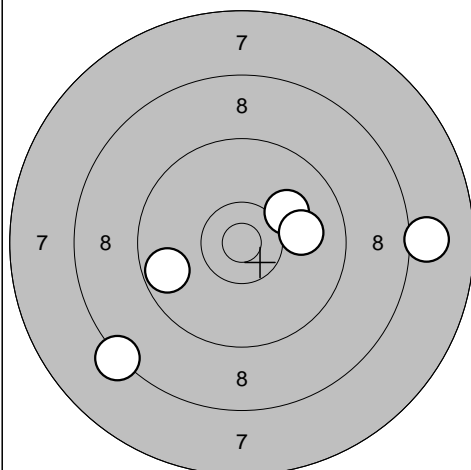

- 1: 10,1 ↗
- 2: 8,3 ↘
- 3: 9,7 ←
- 4: 10,0 →
- 5: 8,0 →

Serie 45,0  
Totalt 45,0

Tävlingsskott

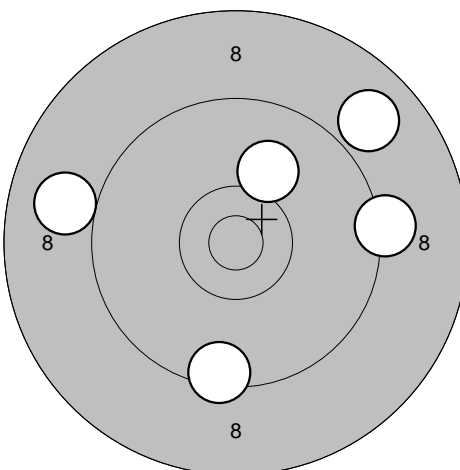

- 6: 8,9 ↗
- 7: 9,5 ↘
- 8: 10,1 ↗
- 9: 9,2 →
- 10: 9,0 ←

Serie 45,0  
Totalt 90,0

Tävlingsskott

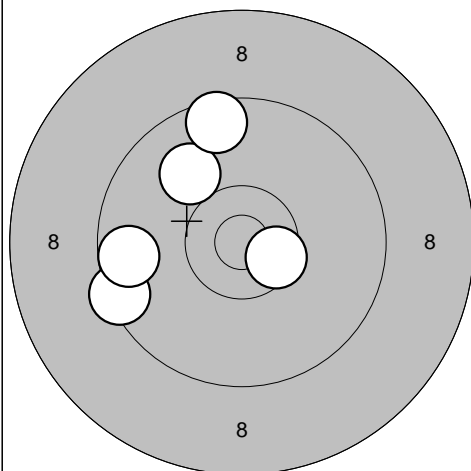

- 11: 10,0 ↗
- 12: 9,4 ←
- 13: 9,6 ↑
- 14: 10,5\* →
- 15: 9,7 ←

Serie 47,0  
Totalt 137,0

Tävlingsskott

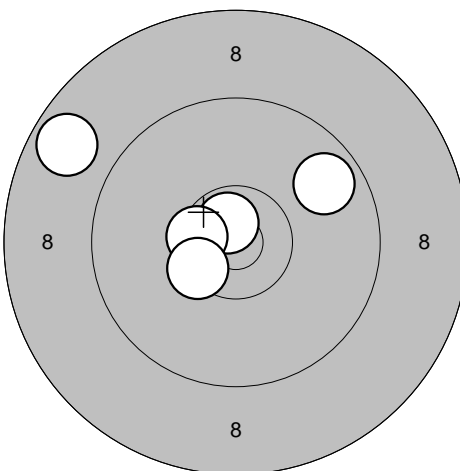

- 16: 8,7 ↘
- 17: 10,7\* ↗
- 18: 9,7 ↗
- 19: 10,5\* ←
- 20: 10,4\* ↘

Serie 47,0  
Totalt 184,0

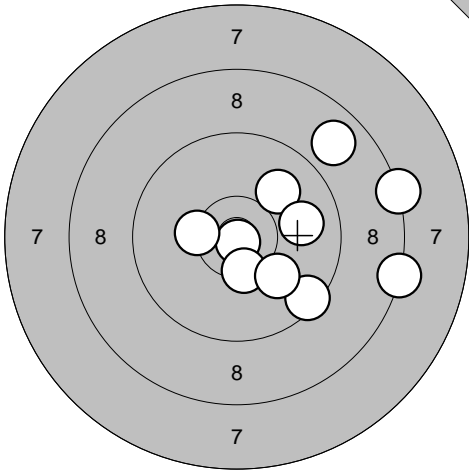
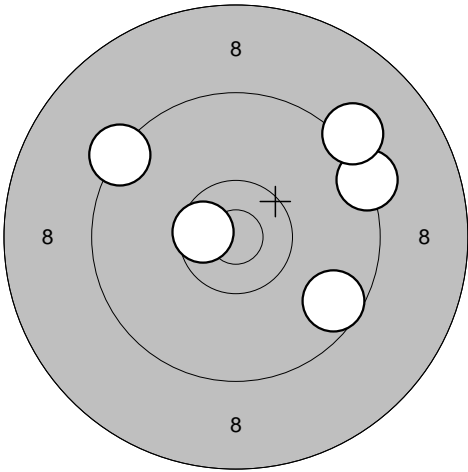
<p>Provs-kott</p> 	<p>Tävlingsskott</p> 	<table style="width:100%; border-collapse: collapse;"> <tr><td style="text-align: right;">1: 10,0</td><td style="text-align: left;">↗</td></tr> <tr><td style="text-align: right;">2: 8,8</td><td style="text-align: left;">↗</td></tr> <tr><td style="text-align: right;">3: 8,3</td><td style="text-align: left;">→</td></tr> <tr><td style="text-align: right;">4: 9,9</td><td style="text-align: left;">→</td></tr> <tr><td style="text-align: right;">5: 10,9*</td><td style="text-align: left;">↓</td></tr> <tr><td style="text-align: right;">6: 10,3*</td><td style="text-align: left;">←</td></tr> <tr><td style="text-align: right;">7: 9,5</td><td style="text-align: left;">↘</td></tr> <tr><td style="text-align: right;">8: 8,3</td><td style="text-align: left;">→</td></tr> <tr><td style="text-align: right;">9: 10,4*</td><td style="text-align: left;">↓</td></tr> <tr><td style="text-align: right;">10: 10,1</td><td style="text-align: left;">↘</td></tr> </table> <table style="width:100%; border-collapse: collapse; margin-top: 5px;"> <tr><td style="text-align: right;">Serie</td><td style="text-align: left;">92,0</td></tr> <tr><td style="text-align: right;">Totalt</td><td style="text-align: left;">0,0</td></tr> </table>	1: 10,0	↗	2: 8,8	↗	3: 8,3	→	4: 9,9	→	5: 10,9*	↓	6: 10,3*	←	7: 9,5	↘	8: 8,3	→	9: 10,4*	↓	10: 10,1	↘	Serie	92,0	Totalt	0,0
1: 10,0	↗																									
2: 8,8	↗																									
3: 8,3	→																									
4: 9,9	→																									
5: 10,9*	↓																									
6: 10,3*	←																									
7: 9,5	↘																									
8: 8,3	→																									
9: 10,4*	↓																									
10: 10,1	↘																									
Serie	92,0																									
Totalt	0,0																									

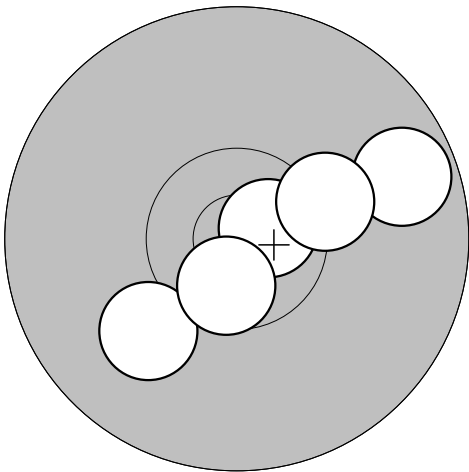
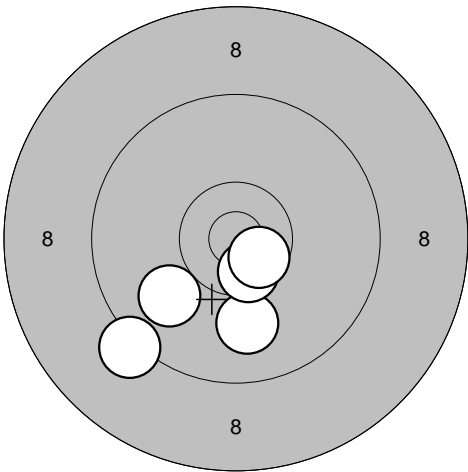
<p>Tävlingsskott</p> 	<p>Tävlingsskott</p> 	<table style="width:100%; border-collapse: collapse;"> <tr><td style="text-align: right;">6: 10,7*</td><td style="text-align: left;">→</td></tr> <tr><td style="text-align: right;">7: 9,7</td><td style="text-align: left;">→</td></tr> <tr><td style="text-align: right;">8: 10,0</td><td style="text-align: left;">↙</td></tr> <tr><td style="text-align: right;">9: 10,6*</td><td style="text-align: left;">↓</td></tr> <tr><td style="text-align: right;">10: 10,3</td><td style="text-align: left;">→</td></tr> </table> <table style="width:100%; border-collapse: collapse; margin-top: 5px;"> <tr><td style="text-align: right;">Serie</td><td style="text-align: left;">49,0</td></tr> <tr><td style="text-align: right;">Totalt</td><td style="text-align: left;">95,0</td></tr> </table>	6: 10,7*	→	7: 9,7	→	8: 10,0	↙	9: 10,6*	↓	10: 10,3	→	Serie	49,0	Totalt	95,0
6: 10,7*	→															
7: 9,7	→															
8: 10,0	↙															
9: 10,6*	↓															
10: 10,3	→															
Serie	49,0															
Totalt	95,0															

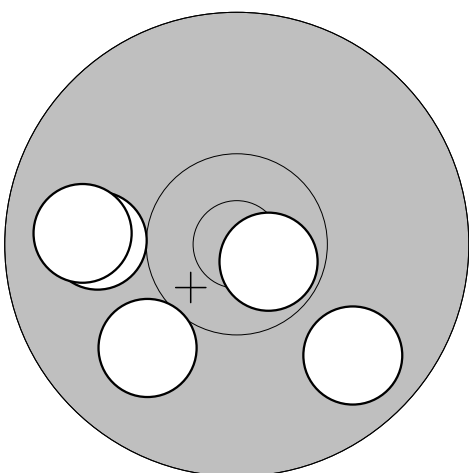
<p>Tävlingsskott</p> 	<table style="width:100%; border-collapse: collapse;"> <tr><td style="text-align: right;">16: 10,0</td><td style="text-align: left;">←</td></tr> <tr><td style="text-align: right;">17: 9,9</td><td style="text-align: left;">←</td></tr> <tr><td style="text-align: right;">18: 10,0</td><td style="text-align: left;">↙</td></tr> <tr><td style="text-align: right;">19: 10,7*</td><td style="text-align: left;">↘</td></tr> <tr><td style="text-align: right;">20: 9,8</td><td style="text-align: left;">↘</td></tr> </table> <table style="width:100%; border-collapse: collapse; margin-top: 5px;"> <tr><td style="text-align: right;">Serie</td><td style="text-align: left;">48,0</td></tr> <tr><td style="text-align: right;">Totalt</td><td style="text-align: left;">192,0</td></tr> </table>	16: 10,0	←	17: 9,9	←	18: 10,0	↙	19: 10,7*	↘	20: 9,8	↘	Serie	48,0	Totalt	192,0	<table style="width:100%; border-collapse: collapse;"> <tr><td style="text-align: right;">11: 10,0</td><td style="text-align: left;">↓</td></tr> <tr><td style="text-align: right;">12: 10,5*</td><td style="text-align: left;">↓</td></tr> <tr><td style="text-align: right;">13: 10,0</td><td style="text-align: left;">↙</td></tr> <tr><td style="text-align: right;">14: 9,2</td><td style="text-align: left;">↙</td></tr> <tr><td style="text-align: right;">15: 10,6*</td><td style="text-align: left;">↘</td></tr> </table> <table style="width:100%; border-collapse: collapse; margin-top: 5px;"> <tr><td style="text-align: right;">Serie</td><td style="text-align: left;">49,0</td></tr> <tr><td style="text-align: right;">Totalt</td><td style="text-align: left;">144,0</td></tr> </table>	11: 10,0	↓	12: 10,5*	↓	13: 10,0	↙	14: 9,2	↙	15: 10,6*	↘	Serie	49,0	Totalt	144,0
16: 10,0	←																													
17: 9,9	←																													
18: 10,0	↙																													
19: 10,7*	↘																													
20: 9,8	↘																													
Serie	48,0																													
Totalt	192,0																													
11: 10,0	↓																													
12: 10,5*	↓																													
13: 10,0	↙																													
14: 9,2	↙																													
15: 10,6*	↘																													
Serie	49,0																													
Totalt	144,0																													

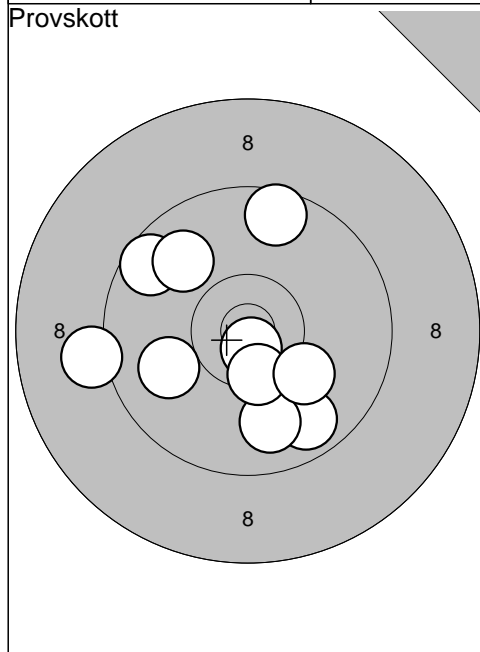

1: 9,6	↖
2: 9,6	↑
3: 10,7*	↓
4: 9,7	↓
5: 9,9	↓
6: 9,1	←
7: 10,4*	↓
8: 10,0	←
9: 9,9	↗
10: 10,1	↓
<hr/>	
Serie	94,0
Totalt	0,0

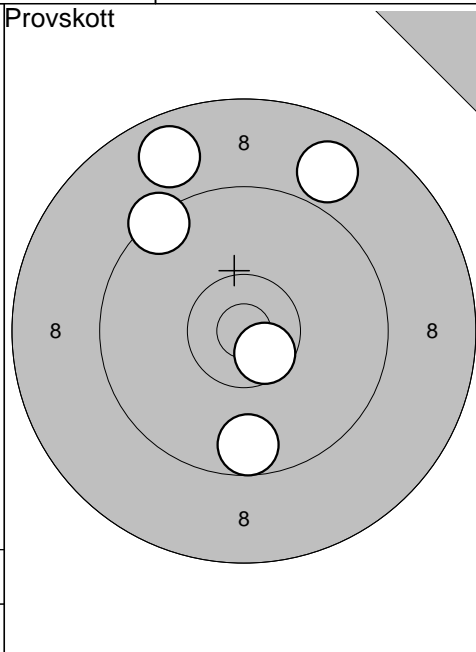

11: 9,6	↓
12: 8,8	↗
13: 10,6*	↓
14: 8,9	↗
15: 9,4	↗
<hr/>	
Serie	44,0
Totalt	0,0

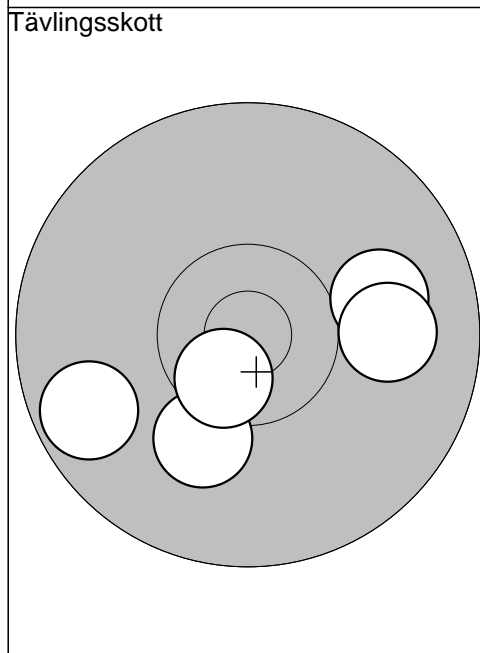

1: 10,0	→
2: 10,0	→
3: 10,1	↓
4: 10,6*	↓
5: 9,7	←
<hr/>	
Serie	49,0
Totalt	49,0

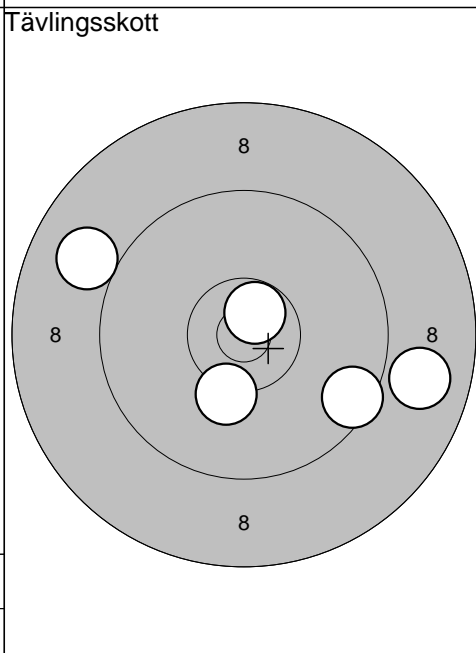

6: 9,5	↘
7: 8,9	→
8: 10,7*	↗
9: 9,0	↖
10: 10,2	↓
<hr/>	
Serie	46,0
Totalt	95,0

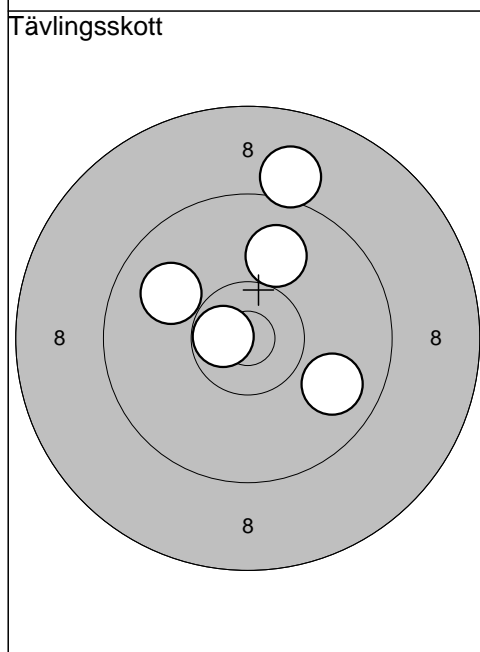

11: 9,9	↖
12: 10,0	↑
13: 9,0	↑
14: 9,8	↘
15: 10,7*	←
<hr/>	
Serie	47,0
Totalt	142,0

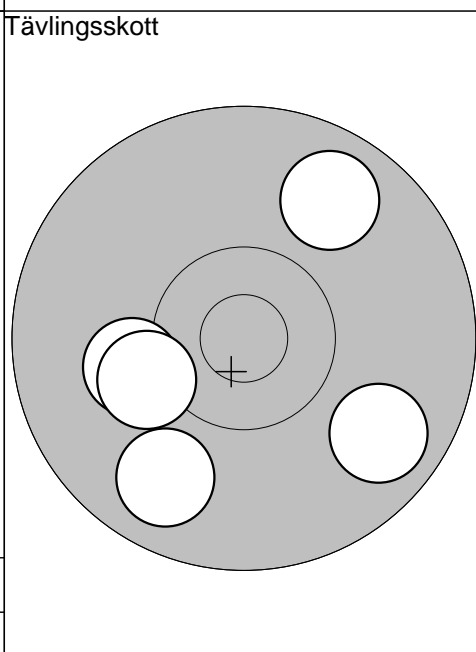

16: 10,1	←
17: 10,2	←
18: 9,8	↓
19: 9,8	↘
20: 9,8	↗
<hr/>	
Serie	47,0
Totalt	189,0

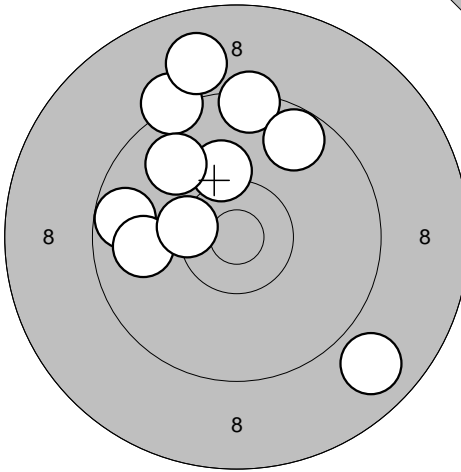
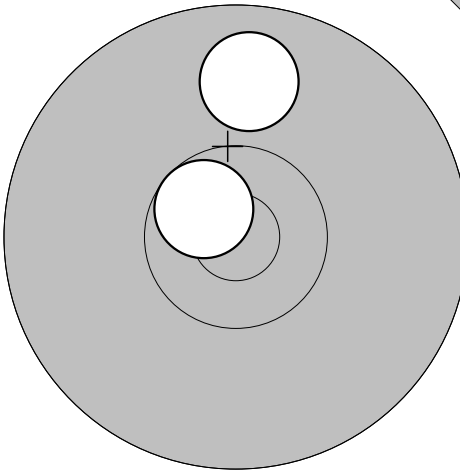
<p>Provs-kott</p> 	<p>1: 8,8 ↘ 2: 9,3 ↗ 3: 8,9 ↗ 4: 9,4 ↗ 5: 10,2 ↗ 6: 9,7 ↖ 7: 9,9 ↖ 8: 9,9 ↗ 9: 10,4* ↖ 10: 9,7 ↗</p> <table border="1" style="width:100%; border-collapse: collapse;"> <tr><td>Serie</td><td style="text-align: right;">90,0</td></tr> <tr><td>Totalt</td><td style="text-align: right;">0,0</td></tr> </table>	Serie	90,0	Totalt	0,0	<p>Provs-kott</p>  <table border="1" style="width:100%; border-collapse: collapse;"> <tr><td>Serie</td><td style="text-align: right;">19,0</td></tr> <tr><td>Totalt</td><td style="text-align: right;">0,0</td></tr> </table>	Serie	19,0	Totalt	0,0
Serie	90,0									
Totalt	0,0									
Serie	19,0									
Totalt	0,0									

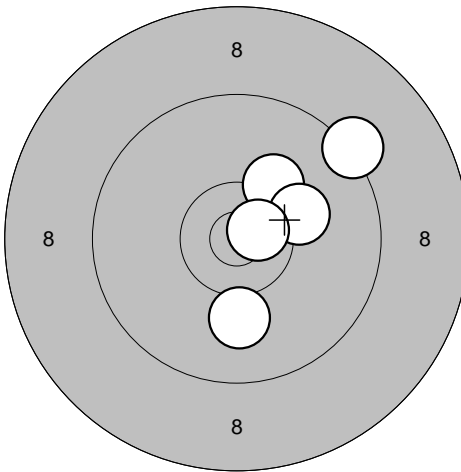
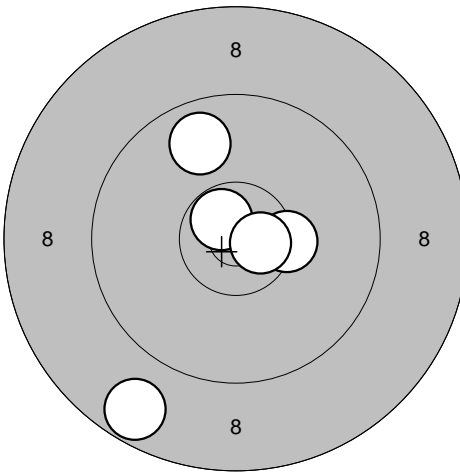
<p>Tävlingsskott</p> 	<p>1: 10,2 ↗ 2: 10,2 → 3: 10,0 ↓ 4: 10,7* → 5: 9,3 ↗</p> <table border="1" style="width:100%; border-collapse: collapse;"> <tr><td>Serie</td><td style="text-align: right;">49,0</td></tr> <tr><td>Totalt</td><td style="text-align: right;">49,0</td></tr> </table>	Serie	49,0	Totalt	49,0	<p>Tävlingsskott</p>  <table border="1" style="width:100%; border-collapse: collapse;"> <tr><td>Serie</td><td style="text-align: right;">47,0</td></tr> <tr><td>Totalt</td><td style="text-align: right;">96,0</td></tr> </table>	Serie	47,0	Totalt	96,0
Serie	49,0									
Totalt	49,0									
Serie	47,0									
Totalt	96,0									

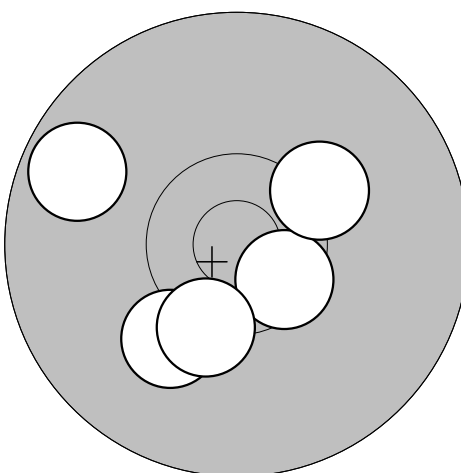
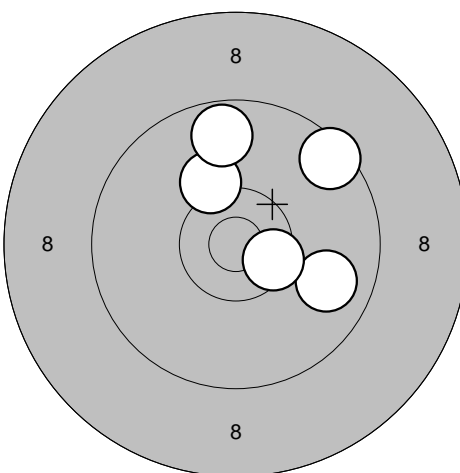
<p>Tävlingsskott</p> 	<p>11: 10,5* ↘ 12: 10,2 ↗ 13: 9,7 ↖ 14: 10,1 ↘ 15: 10,3* ↘</p> <table border="1" style="width:100%; border-collapse: collapse;"> <tr><td>Serie</td><td style="text-align: right;">49,0</td></tr> <tr><td>Totalt</td><td style="text-align: right;">145,0</td></tr> </table>	Serie	49,0	Totalt	145,0	<p>Tävlingsskott</p>  <table border="1" style="width:100%; border-collapse: collapse;"> <tr><td>Serie</td><td style="text-align: right;">47,0</td></tr> <tr><td>Totalt</td><td style="text-align: right;">192,0</td></tr> </table>	Serie	47,0	Totalt	192,0
Serie	49,0									
Totalt	145,0									
Serie	47,0									
Totalt	192,0									

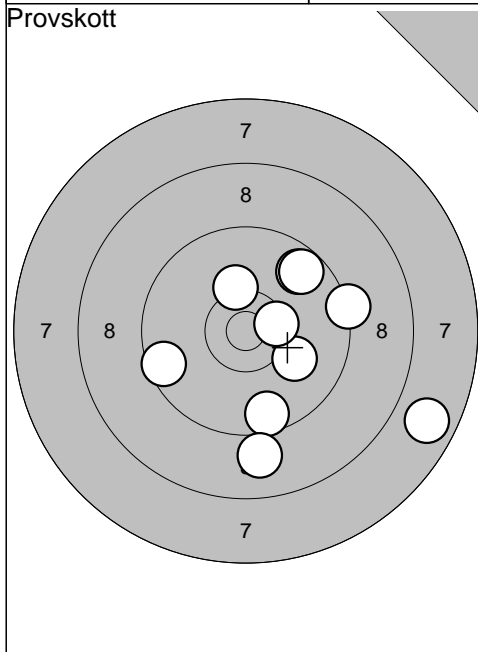

1: 9,6	↓
2: 7,8	→
3: 9,7	↗
4: 10,3	↑
5: 10,1	→
6: 10,5*	→
7: 9,7	↗
8: 9,3	→
9: 9,6	←
10: 9,0	↓
<b>Serie 91,0</b>	
<b>Totalt 0,0</b>	

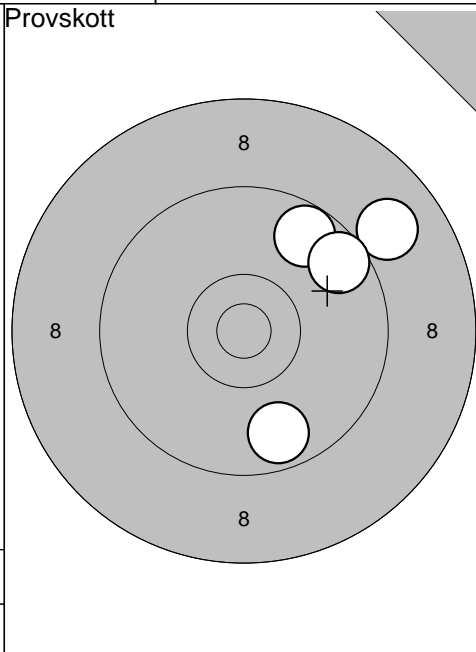

11: 9,7	↗
12: 8,9	↗
13: 9,6	↗
14: 9,7	↓
<b>Serie 35,0</b>	
<b>Totalt 0,0</b>	

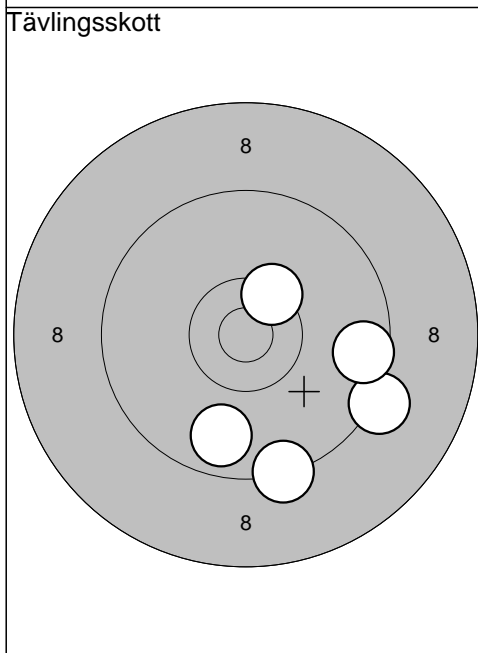

1: 9,2	→
2: 9,3	↓
3: 9,6	→
4: 9,8	↓
5: 10,4*	↗
<b>Serie 46,0</b>	
<b>Totalt 46,0</b>	

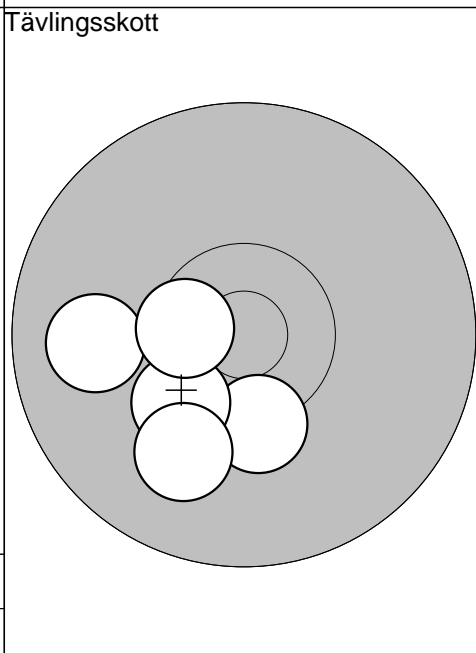

6: 10,3*	↓
7: 10,3*	↙
8: 9,9	←
9: 10,5*	←
10: 10,0	↙
<b>Serie 49,0</b>	
<b>Totalt 95,0</b>	

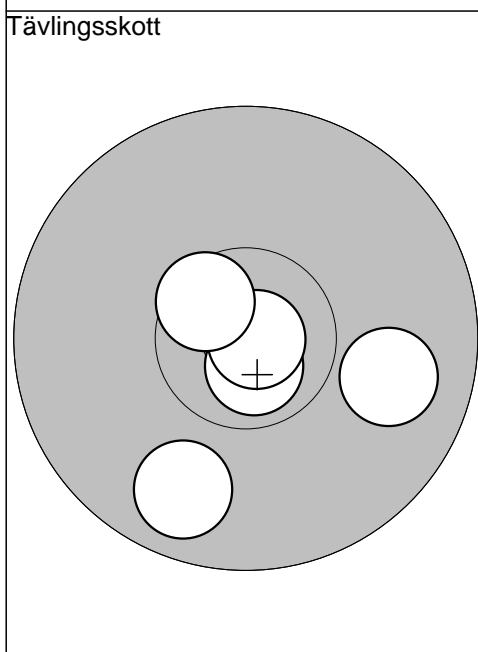

11: 9,8	↓
12: 10,7*	↓
13: 10,9*	→
14: 9,9	→
15: 10,6*	↗
<b>Serie 48,0</b>	
<b>Totalt 143,0</b>	

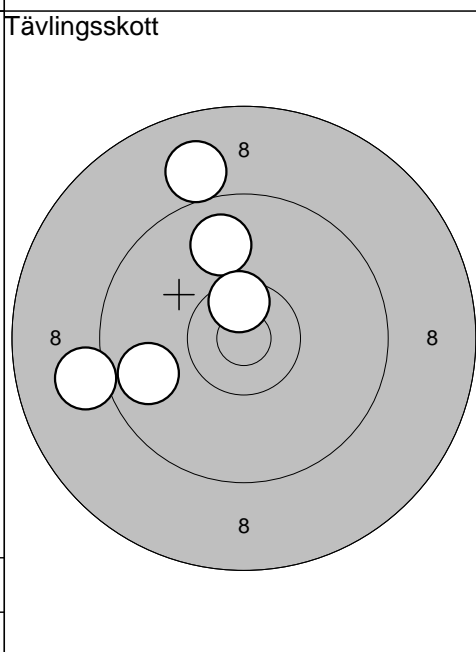

16: 9,8	←
17: 9,0	↑
18: 9,9	↑
19: 9,1	←
20: 10,5*	↑
<b>Serie 46,0</b>	
<b>Totalt 189,0</b>	

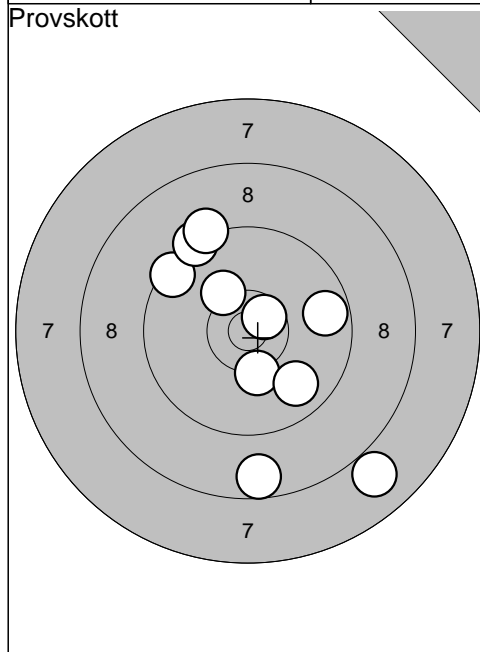

1: 9,5	↖
2: 9,4	↗
3: 9,2	↗
4: 10,3	↘
5: 9,8	↘
6: 10,6*	↗
7: 9,7	→
8: 10,2	↗
9: 7,9	↘
10: 8,6	↓
Serie 90,0	
Totalt 0,0	

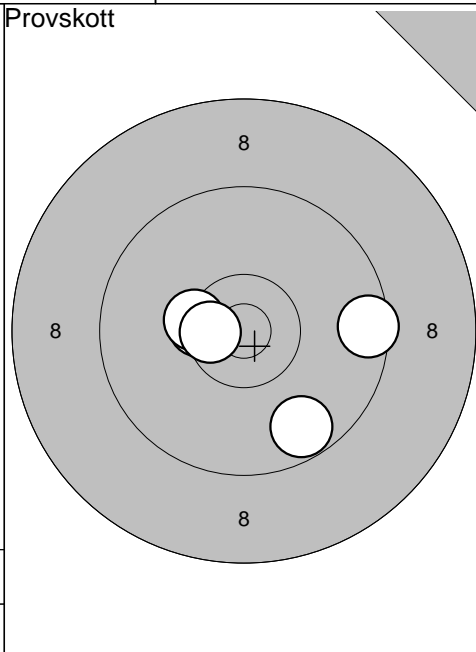

11: 9,7	↘
12: 9,5	→
13: 10,4*	←
14: 10,4*	←
15: 10,6*	←
Serie 48,0	
Totalt 0,0	

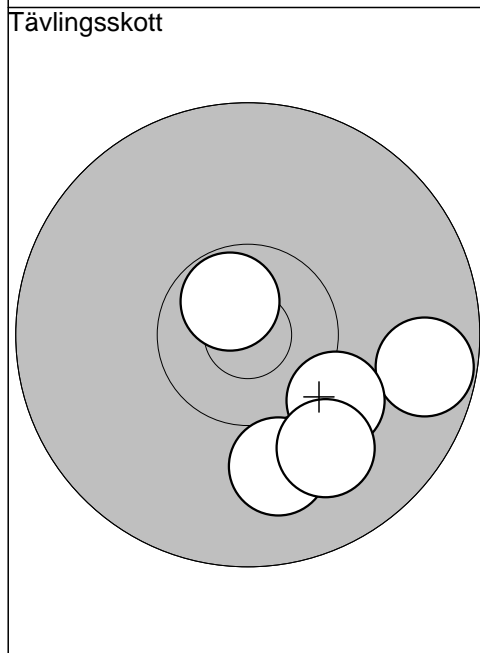

1: 9,7	→
2: 10,2	↘
3: 10,7*	↗
4: 10,0	↘
5: 10,0	↘
Serie 49,0	
Totalt 49,0	

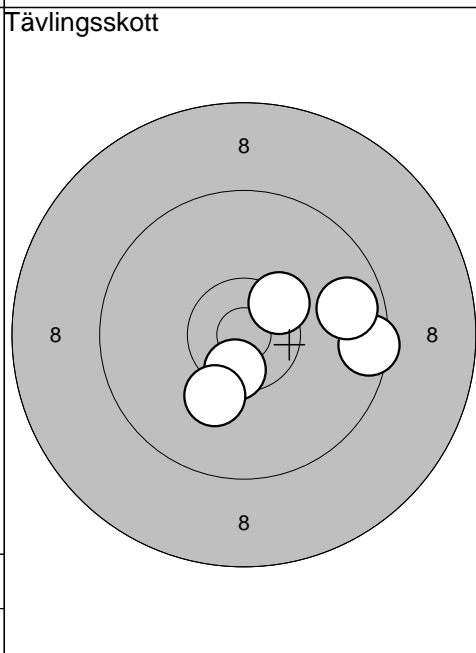

6: 10,5*	↘
7: 10,2	↘
8: 9,5	→
9: 9,7	→
10: 10,4*	↗
Serie 48,0	
Totalt 97,0	

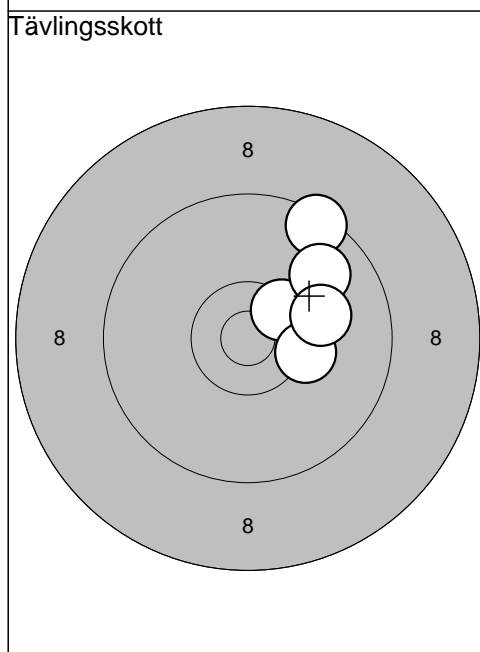

11: 9,4	↗
12: 10,4*	↗
13: 9,8	↗
14: 10,3	→
15: 10,1	→
Serie 48,0	
Totalt 145,0	

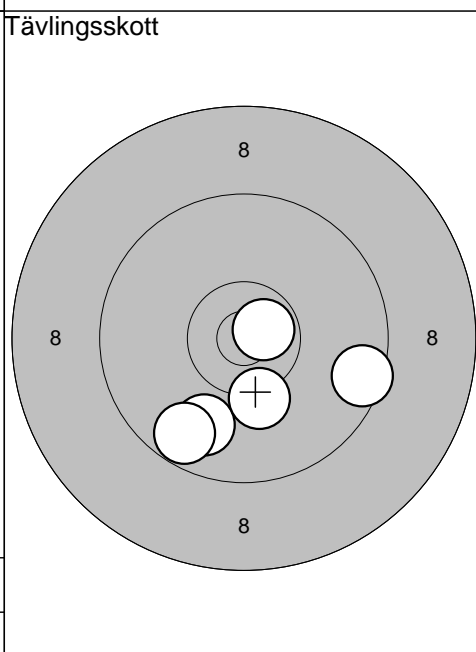

16: 9,9	↘
17: 10,7*	↗
18: 9,5	→
19: 10,2	↘
20: 9,7	↘
Serie 47,0	
Totalt 192,0	

I 16 / Lv 6

2009-07-16

Tavelträffen 2009

Ramselefors SKF

Provsjött

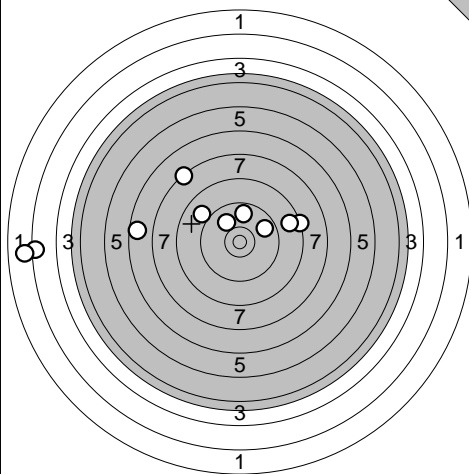

- 1: 7,4 ↗
- 2: 2,5 ←
- 3: 2,0 ←
- 4: 6,7 ←
- 5: 8,3 →
- 6: 8,7 →
- 7: 9,8 →
- 8: 9,8 ↑
- 9: 9,0 ↖
- 10: 10,0 ↖

Serie 70,0

Totalt 0,0

Provsjött

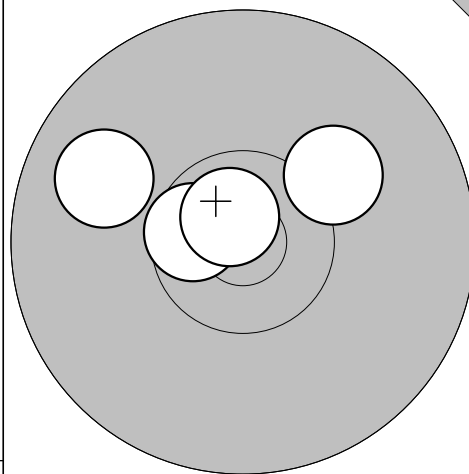

- 11: 10,2 ↗
- 12: 10,6\* ←
- 13: 10,8\* ↗
- 14: 9,9 ↖

Serie 39,0

Totalt 0,0

Tävlingssjött

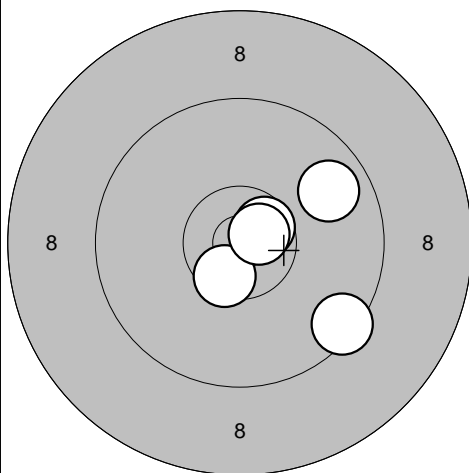

- 1: 9,8 ↗
- 2: 10,6\* ↗
- 3: 10,5\* ↘
- 4: 10,7\* →
- 5: 9,4 ↘

Serie 48,0

Totalt 48,0

Tävlingssjött

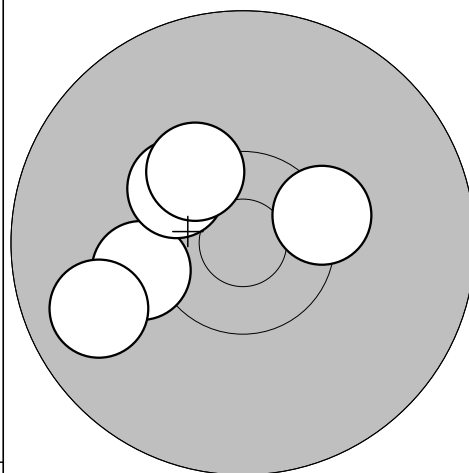

- 6: 10,2 ←
- 7: 10,3\* ↖
- 8: 10,4\* →
- 9: 9,8 ←
- 10: 10,3\* ↖

Serie 49,0

Totalt 97,0

Tävlingssjött

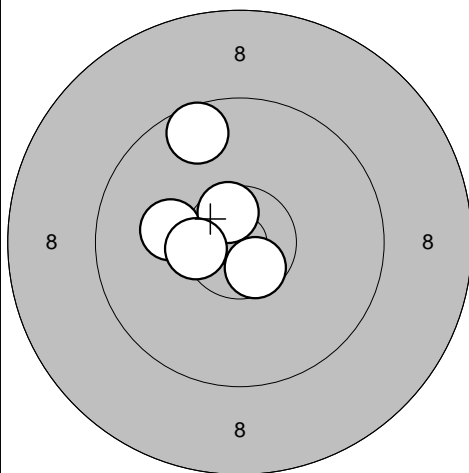

- 11: 10,1 ←
- 12: 10,6\* ↗
- 13: 10,6\* ↘
- 14: 10,4\* ←
- 15: 9,6 ↗

Serie 49,0

Totalt 146,0

Tävlingssjött

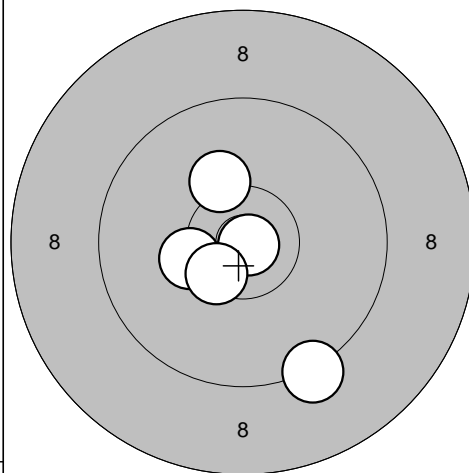

- 16: 10,2 ↗
- 17: 10,3\* ←
- 18: 9,3 ↘
- 19: 10,9\* →
- 20: 10,5\* ↘

Serie 49,0

Totalt 195,0

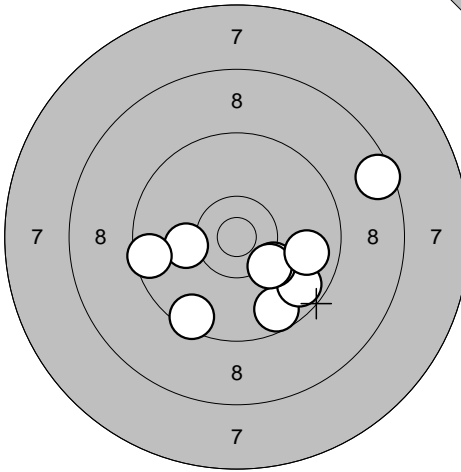
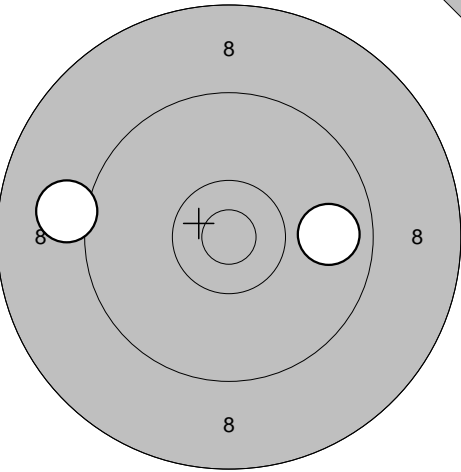
<p>Provskott</p> 	<p>1: 8,5 →</p> <p>2: 9,6 ↓</p> <p>3: 9,5 ↓</p> <p>4: 9,7 ↓</p> <p>5: 10,2 ↓</p> <p>6: 10,1 ←</p> <p>7: 0,0 ↓</p> <p>8: 9,5 ←</p> <p>9: 10,2 ↓</p> <p>10: 9,8 →</p>	<p>Provskott</p> 
Serie 83,0		Serie 18,0
Totalt 0,0		Totalt 0,0

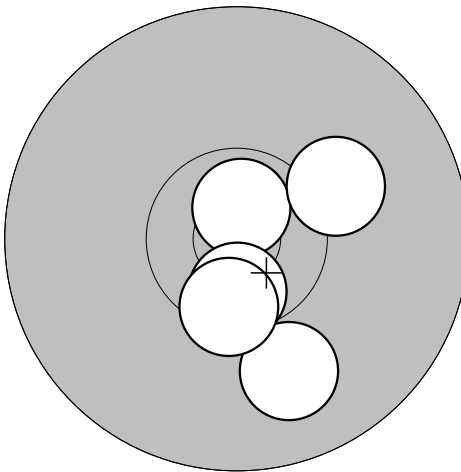
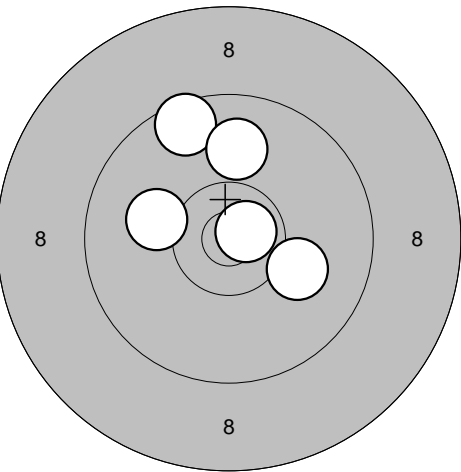
<p>Tävlingsskott</p> 	<p>1: 10,7* ↑</p> <p>2: 10,6* ↓</p> <p>3: 9,9 ↓</p> <p>4: 10,5* ↓</p> <p>5: 10,2 →</p>	<p>Tävlingsskott</p> 
Serie 49,0		Serie 48,0
Totalt 49,0		Totalt 97,0

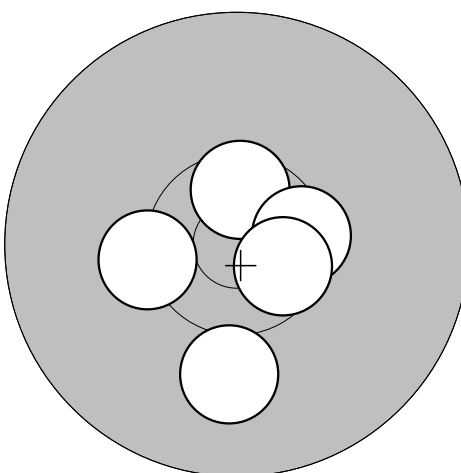
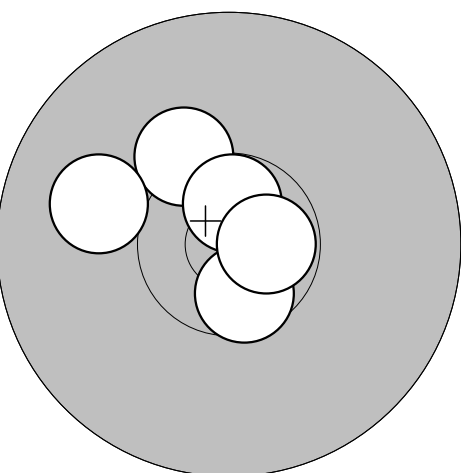
<p>Tävlingsskott</p> 	<p>11: 10,6* ↑</p> <p>12: 10,5* →</p> <p>13: 10,6* →</p> <p>14: 10,3* ←</p> <p>15: 10,0 ↓</p>	<p>Tävlingsskott</p> 
Serie 50,0		Serie 50,0
Totalt 147,0		Totalt 197,0

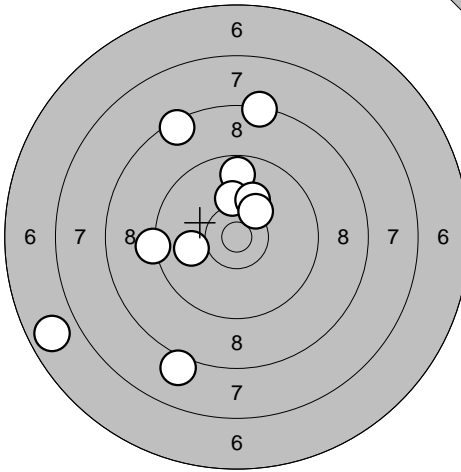
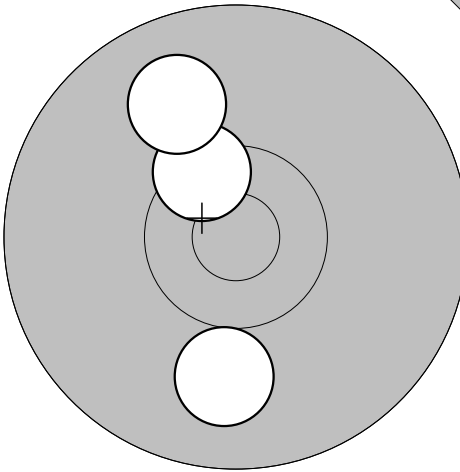

<p>Provskott</p> 	<p>1: 9,7    ↗</p> <p>2: 8,4    ↗</p> <p>3: 10,2   ↗</p> <p>4: 8,5    ↘</p> <p>5: 10,1   ↗</p> <p>6: 8,1    ↘</p> <p>7: 9,3    ←</p> <p>8: 10,3*   ↗</p> <p>9: 10,0   ←</p> <p>10: 6,8   ↙</p>	<p>Provskott</p> 
Serie    88,0		Serie    29,0
Totalt   0,0		Totalt   0,0

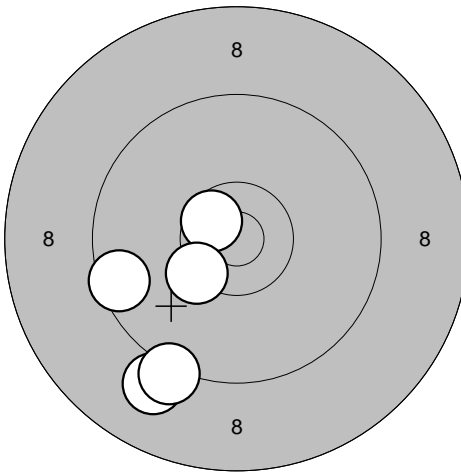
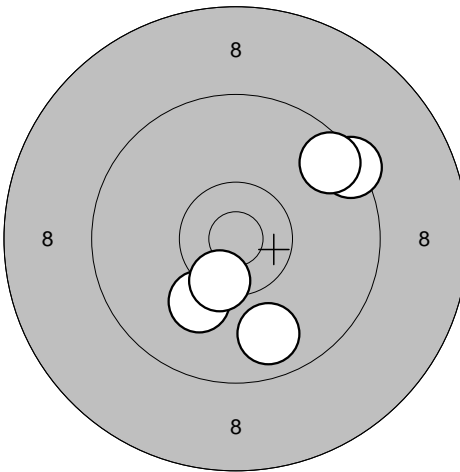
<p>Tävlingsskott</p> 	<p>1: 10,6*   ↘</p> <p>2: 9,5    ←</p> <p>3: 9,0    ↘</p> <p>4: 10,3*   ↘</p> <p>5: 9,2    ↘</p>	<p>Tävlingsskott</p> 
Serie    47,0		Serie    47,0
Totalt   47,0		Totalt   94,0

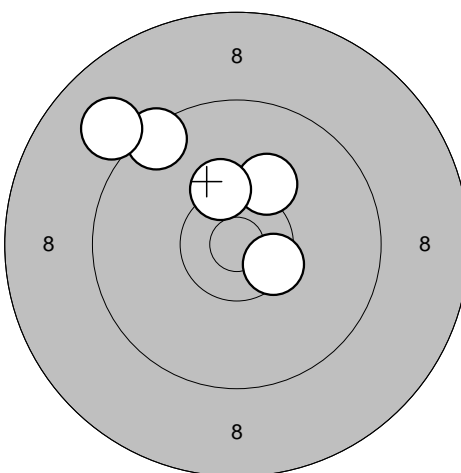
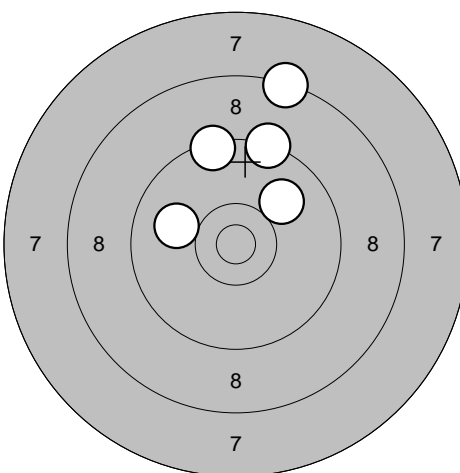
<p>Tävlingsskott</p> 	<p>11: 10,5*   ↘</p> <p>12: 10,2    ↗</p> <p>13: 10,3*   ↗</p> <p>14: 9,4    ↗</p> <p>15: 9,0    ↗</p>	<p>Tävlingsskott</p> 
Serie    48,0		Serie    46,0
Totalt   142,0		Totalt   188,0

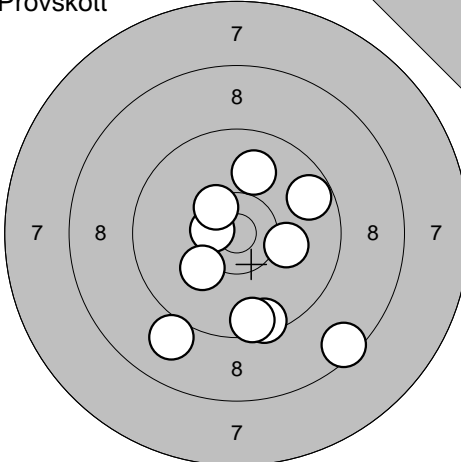
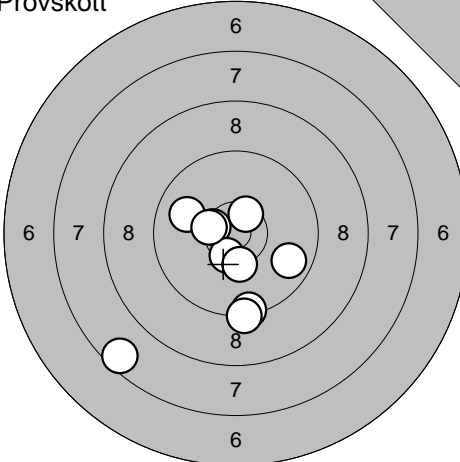
<p>Provskott</p> 	<p>1: 8,5 ↘ 2: 9,0 ↘ 3: 10,0 ↗ 4: 10,6* ← 5: 9,5 ↘ 6: 10,4* ↗ 7: 10,1 → 8: 9,7 → 9: 9,6 ↘ 10: 10,2 ↘</p> <p>Serie 94,0 Totalt 0,0</p>	<p>Provskott</p> 	<p>11: 10,5* ← 12: 10,5* ↗ 13: 9,4 ↘ 14: 9,7 → 15: 10,5* ↘ 16: 9,9 ↗ 17: 7,6 ↘ 18: 10,4* ← 19: 10,3* ↘ 20: 9,3 ↘</p> <p>Serie 93,0 Totalt 0,0</p>
---	---	---	---

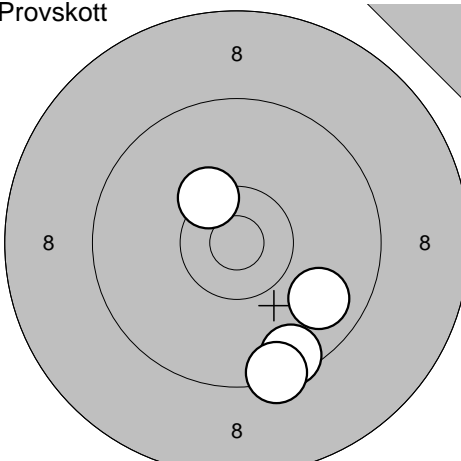
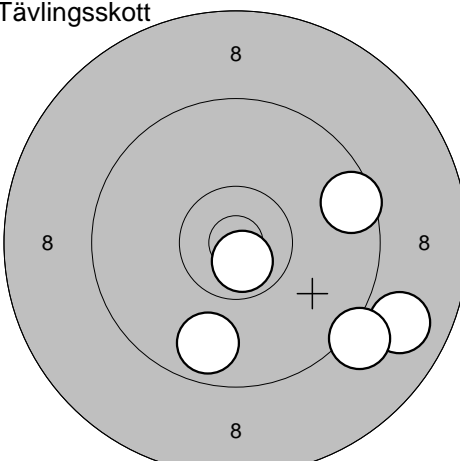
<p>Provskott</p> 	<p>21: 9,5 ↘ 22: 9,4 ↘ 23: 9,8 ↘ 24: 10,3* ↗</p> <p>Serie 37,0 Totalt 0,0</p>	<p>Tävlingsskott</p> 	<p>1: 10,7* ↘ 2: 8,9 → 3: 9,2 ↘ 4: 9,8 ↘ 5: 9,6 →</p> <p>Serie 45,0 Totalt 45,0</p>
--	---	--	---

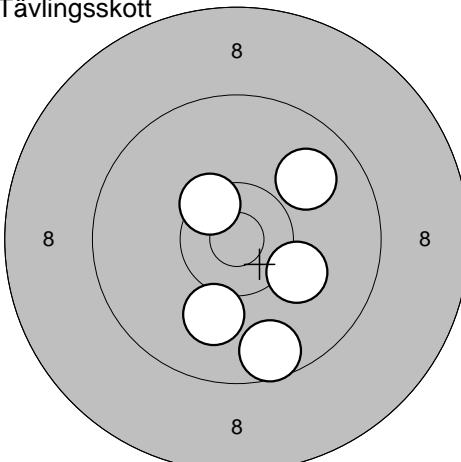
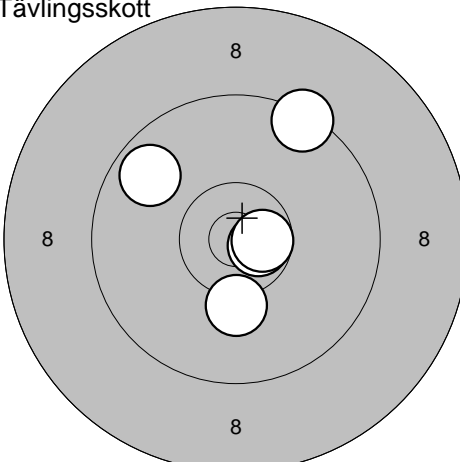
<p>Tävlingsskott</p> 	<p>6: 10,0 ↘ 7: 10,5* ↗ 8: 9,9 ↗ 9: 10,2 → 10: 9,6 ↘</p> <p>Serie 48,0 Totalt 93,0</p>	<p>Tävlingsskott</p> 	<p>11: 9,7 ↗ 12: 9,4 ↗ 13: 10,2 ↘ 14: 10,7* → 15: 10,6* →</p> <p>Serie 48,0 Totalt 141,0</p>
---	--	---	--

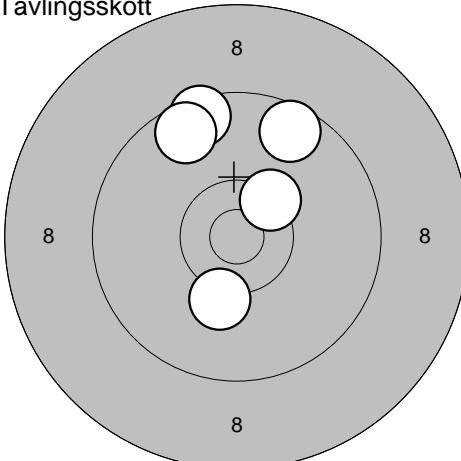
<p>Tävlingsskott</p> 	<p>16: 10,2 ↘ 17: 10,4* ↗ 18: 9,5 ↗ 19: 9,6 ↗ 20: 9,6 ↗</p> <p>Serie 47,0 Totalt 188,0</p>		
---	--	--	--

2009-07-16

Tavelträffen 2009

Ramselefors SKF

Provskott

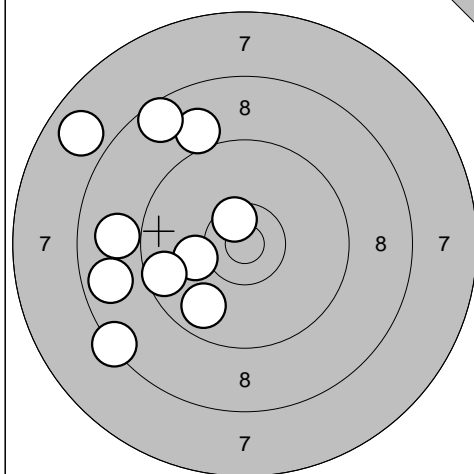

1: 7,8 ↖  
 2: 8,8 ←  
 3: 8,4 ↙  
 4: 9,0 ←  
 5: 10,1 ←  
 6: 9,6 ↙  
 7: 9,0 ↗  
 8: 9,8 ↘  
 9: 10,5\* ↗  
 10: 8,6 ↖

Serie 87,0

Totalt 0,0

Provskott

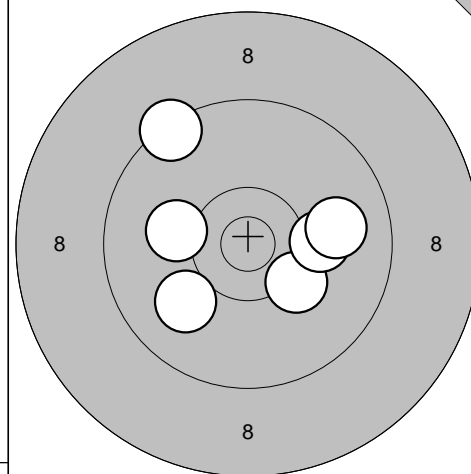

11: 9,4 ↗  
 12: 10,0 ↘  
 13: 10,2 ↘  
 14: 10,1 →  
 15: 10,1 ←  
 16: 9,9 →

Serie 58,0

Totalt 0,0

Tävlingsskott

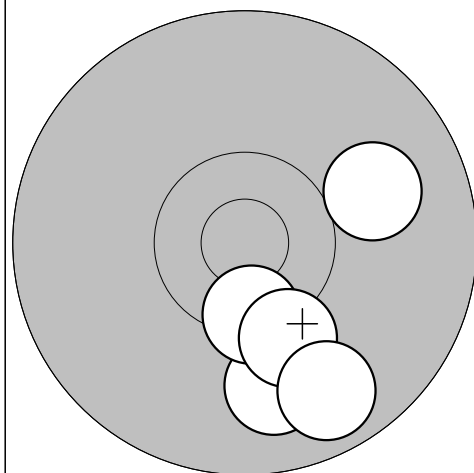

1: 10,0 →  
 2: 9,9 ↓  
 3: 10,4\* ↓  
 4: 10,2 ↓  
 5: 9,7 ↓

Serie 48,0

Totalt 48,0

Tävlingsskott

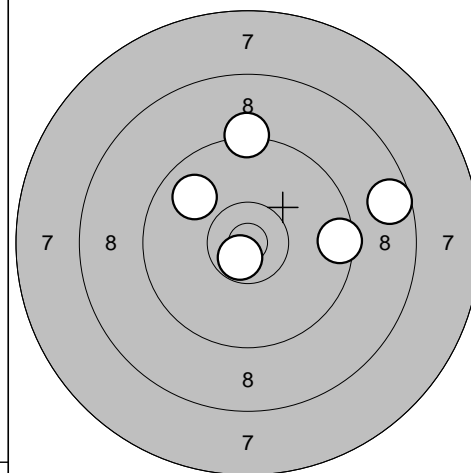

6: 8,6 →  
 7: 9,5 →  
 8: 10,7\* ↘  
 9: 9,3 ↑  
 10: 9,9 ↖

Serie 45,0

Totalt 93,0

Tävlingsskott

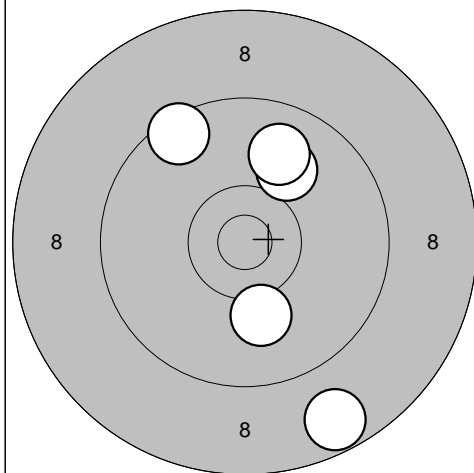

11: 10,1 ↓  
 12: 10,0 ↗  
 13: 9,5 ↗  
 14: 9,9 ↗  
 15: 8,7 ↓

Serie 46,0

Totalt 139,0

Tävlingsskott

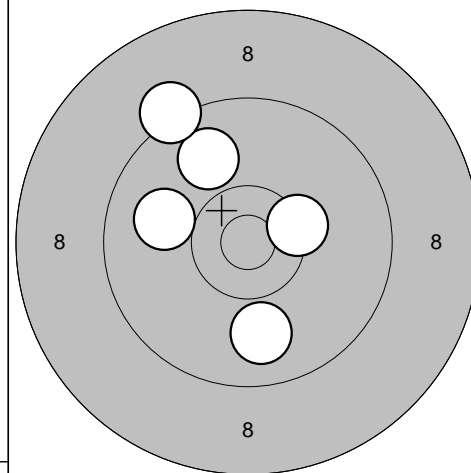

16: 9,9 ↓  
 17: 10,4\* →  
 18: 9,9 ↗  
 19: 10,0 ←  
 20: 9,2 ↗

Serie 47,0

Totalt 186,0

Ramselefors

2009-07-16

Tavelträffen 2009

Ramselefors SKF

Provskott

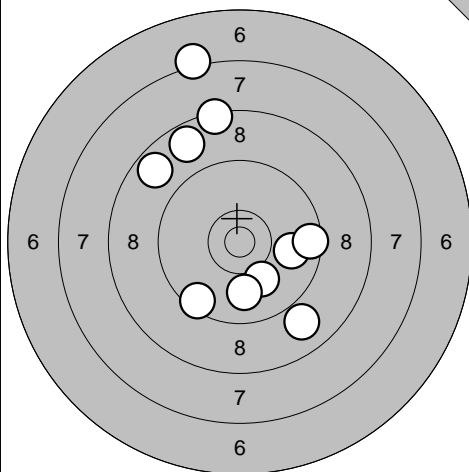

1: 7,2 ↗  
 2: 8,4 ↗  
 3: 8,7 ↗  
 4: 10,1 ↘  
 5: 8,9 ↘  
 6: 9,5 ↘  
 7: 9,9 →  
 8: 9,5 →  
 9: 8,7 ↗  
 10: 9,9 ↓

Serie 85,0

Totalt 0,0

Provskott

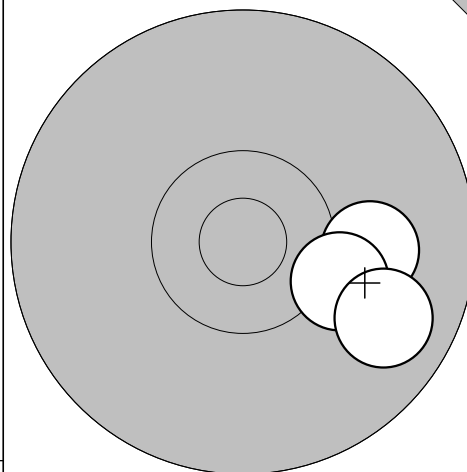

11: 10,0 →  
 12: 10,2 ↘  
 13: 9,8 ↘

Serie 29,0

Totalt 0,0

Tävlingsskott

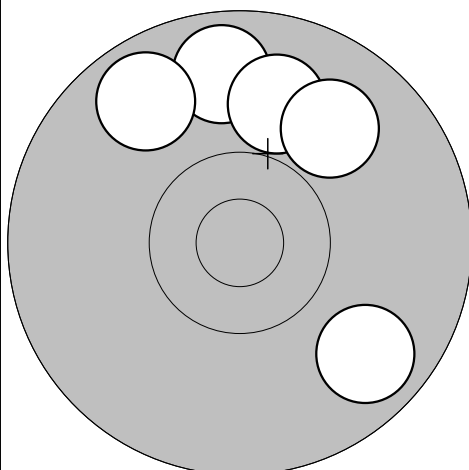

1: 9,7 ↗  
 2: 9,9 ↗  
 3: 9,7 ↗  
 4: 9,9 ↗  
 5: 9,8 ↘

Serie 45,0

Totalt 45,0

Tävlingsskott

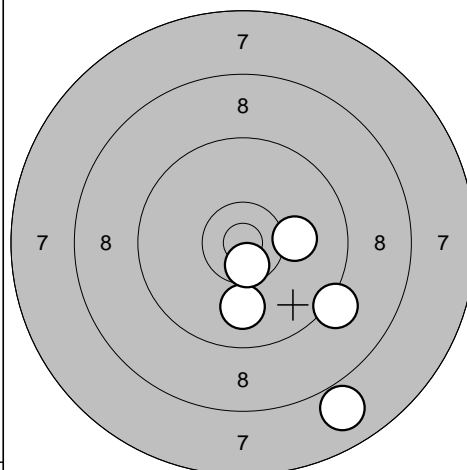

6: 9,2 ↘  
 7: 10,1 →  
 8: 9,9 ↓  
 9: 7,9 ↘  
 10: 10,6\* ↓

Serie 45,0

Totalt 90,0

Tävlingsskott

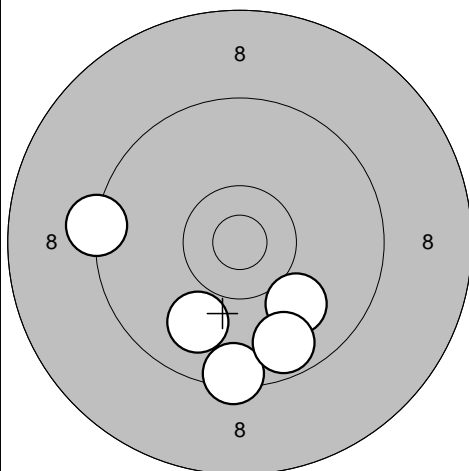

11: 9,4 ↓  
 12: 10,0 ↘  
 13: 9,7 ↘  
 14: 9,9 ↘  
 15: 9,3 ←

Serie 46,0

Totalt 136,0

Tävlingsskott

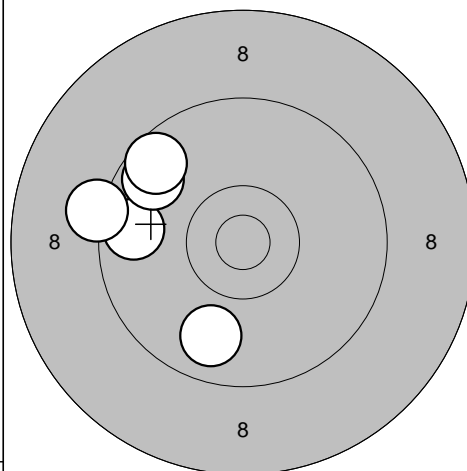

16: 9,8 ↓  
 17: 9,7 ←  
 18: 9,7 ↗  
 19: 9,6 ↗  
 20: 9,3 ←

Serie 45,0

Totalt 181,0

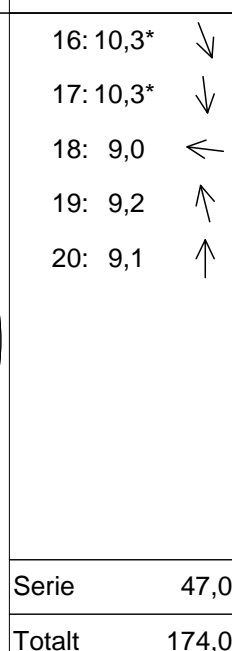
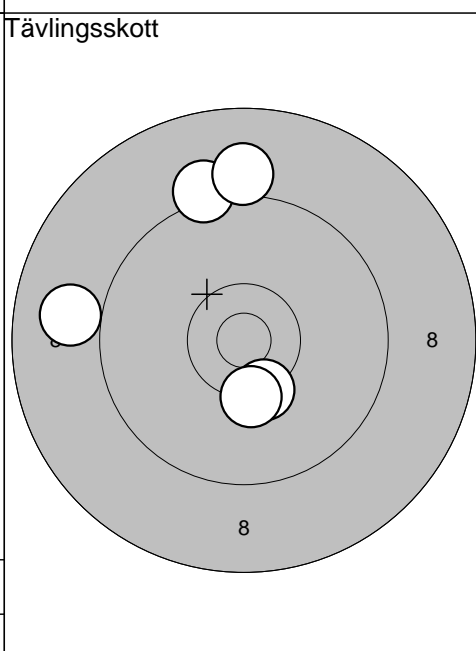
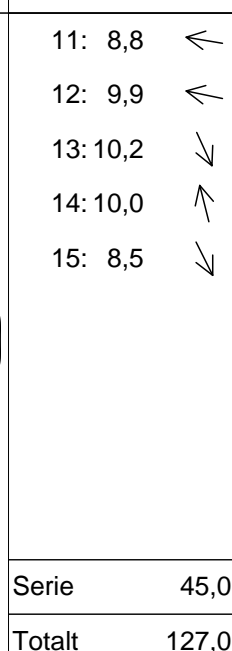
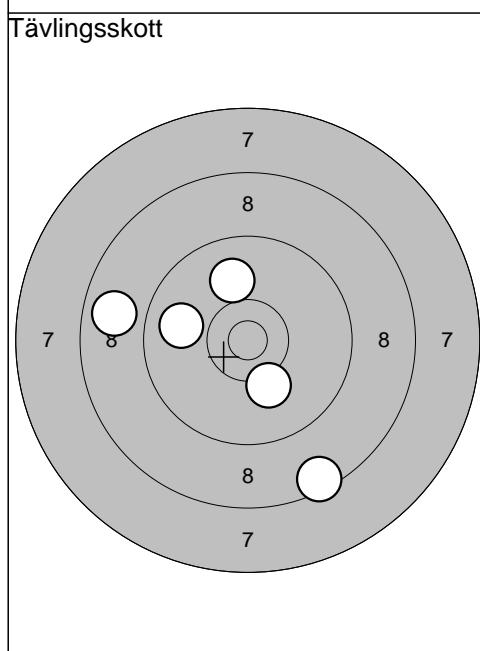
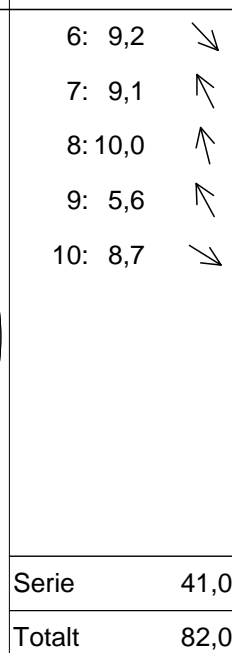
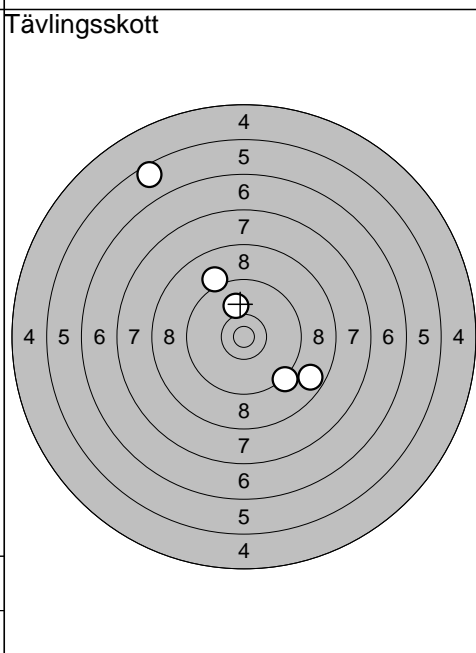
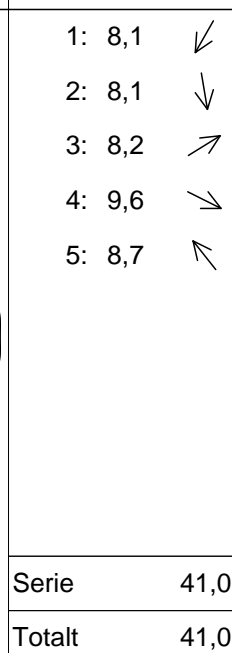
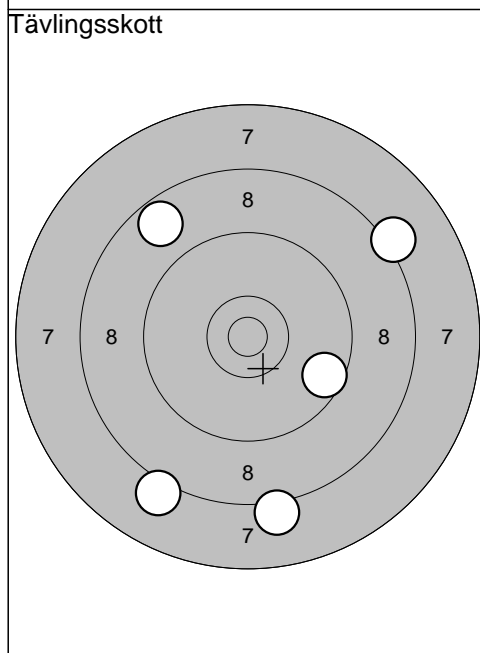
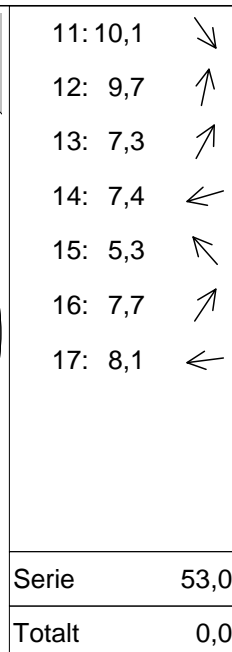
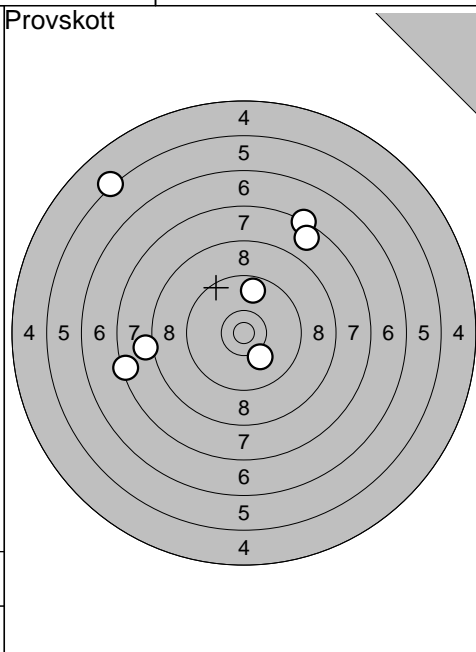
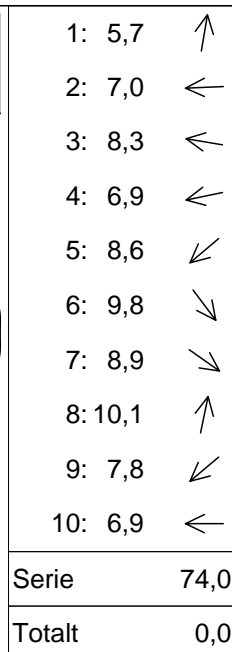
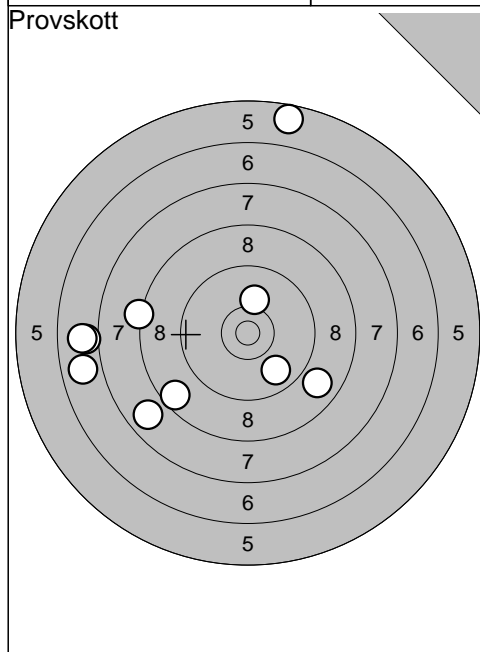

Ununge

2009-07-16

Tavelträffen 2009

Ramselefors SKF

Provskott

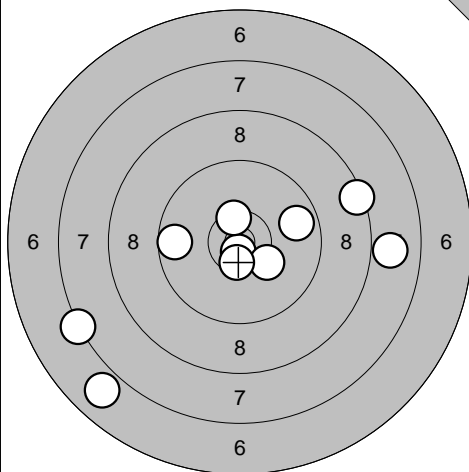

- 1: 8,4 →
- 2: 7,9 →
- 3: 9,8 →
- 4: 10,7\* ↓
- 5: 9,7 ←
- 6: 10,3 ↘
- 7: 10,5\* ↑
- 8: 7,3 ↙
- 9: 6,9 ↙
- 10: 10,5\* ↓

Serie 86,0  
Totalt 0,0

Provskott

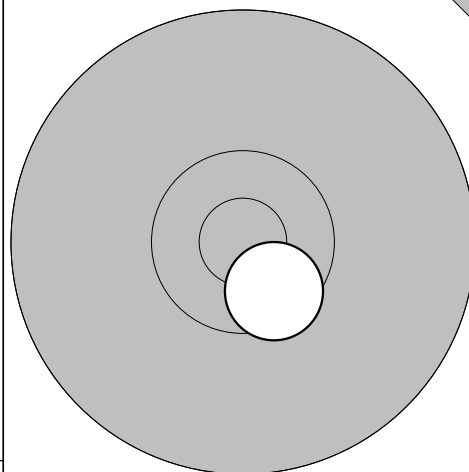

11: 10,5\* ↓

Serie 10,0  
Totalt 0,0

Tävlingsskott

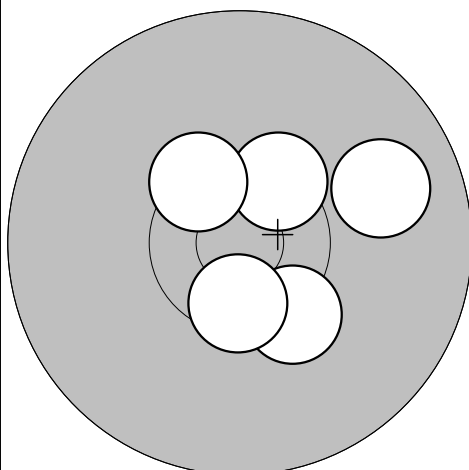

- 1: 10,3\* ↘
- 2: 10,4\* ↗
- 3: 9,9 →
- 4: 10,4\* ↗
- 5: 10,5\* ↓

Serie 49,0  
Totalt 49,0

Tävlingsskott

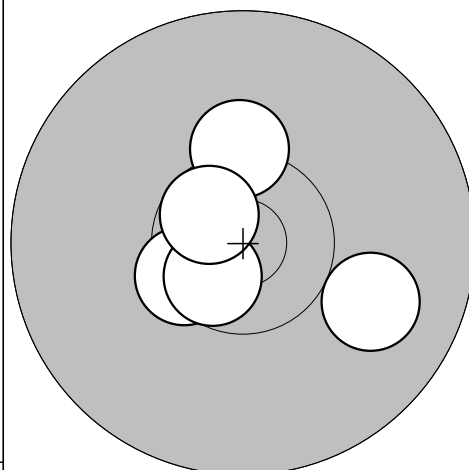

- 6: 9,9 ↘
- 7: 10,3\* ↑
- 8: 10,5\* ↙
- 9: 10,6\* ↙
- 10: 10,6\* ↗

Serie 49,0  
Totalt 98,0

Tävlingsskott

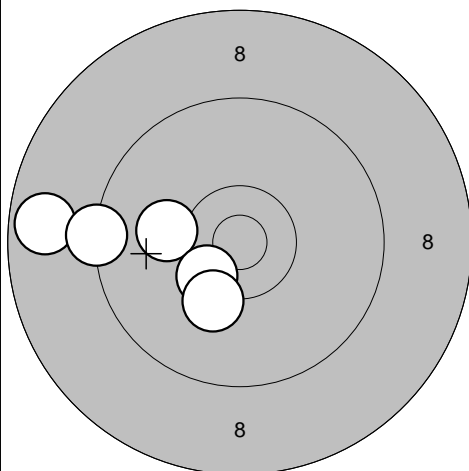

- 11: 10,1 ←
- 12: 8,7 ←
- 13: 10,4\* ↙
- 14: 10,2 ↓
- 15: 9,3 ←

Serie 47,0  
Totalt 145,0

Tävlingsskott

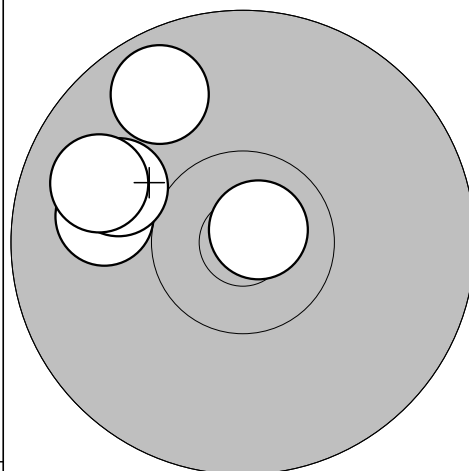

- 16: 10,0 ←
- 17: 10,0 ↙
- 18: 9,8 ↗
- 19: 9,9 ↙
- 20: 10,8\* ↗

Serie 48,0  
Totalt 193,0

Ununge

2009-07-16

Tavelträffen 2009

Ramselefors SKF

Provskott

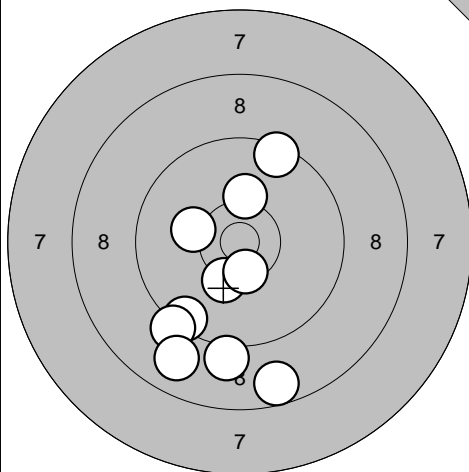

1: 9,5 ↘  
 2: 9,2 ↘  
 3: 9,1 ↘  
 4: 8,9 ↘  
 5: 10,3\* ↘  
 6: 10,2 ←  
 7: 10,5\* ↘  
 8: 9,5 ↗  
 9: 10,2 ↗  
 10: 8,6 ↘

Serie 92,0

Totalt 0,0

Provskott

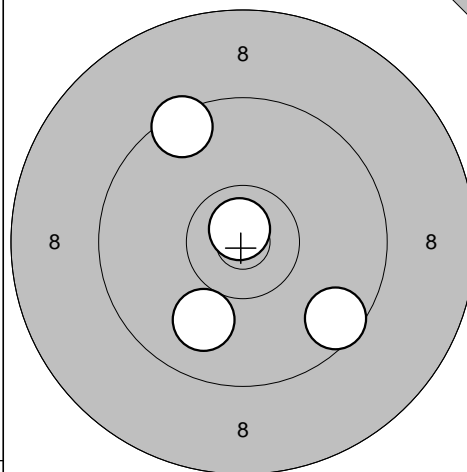

11: 10,8\* ↗  
 12: 9,6 ↘  
 13: 10,0 ↘  
 14: 9,5 ↗

Serie 38,0

Totalt 0,0

Tävlingsskott

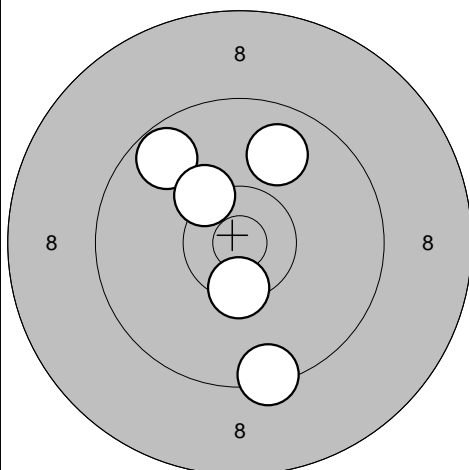

1: 9,7 ↗  
 2: 9,9 ↗  
 3: 10,4\* ↘  
 4: 10,3 ↗  
 5: 9,4 ↘

Serie 47,0

Totalt 47,0

Tävlingsskott

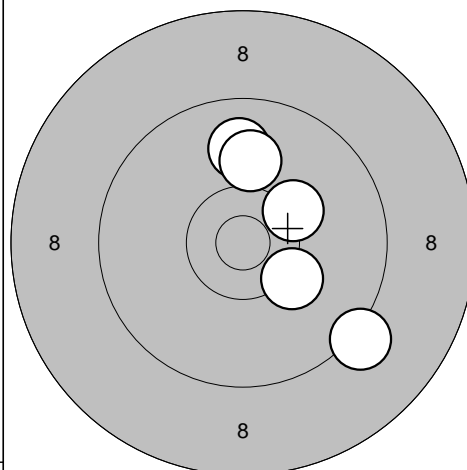

6: 9,9 ↗  
 7: 10,3 ↗  
 8: 10,0 ↗  
 9: 10,3 ↘  
 10: 9,2 ↘

Serie 48,0

Totalt 95,0

Tävlingsskott

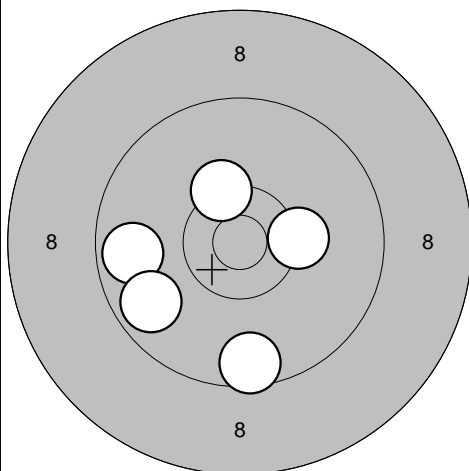

11: 9,7 ←  
 12: 10,3 →  
 13: 9,7 ↘  
 14: 9,6 ↘  
 15: 10,3\* ↗

Serie 47,0

Totalt 142,0

Tävlingsskott

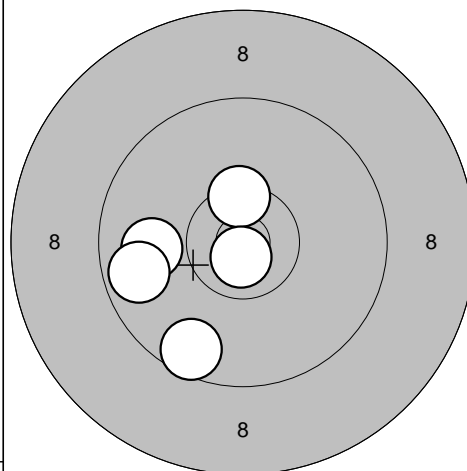

16: 9,9 ←  
 17: 9,7 ←  
 18: 9,6 ↘  
 19: 10,4\* ↗  
 20: 10,8\* ↘

Serie 47,0

Totalt 189,0

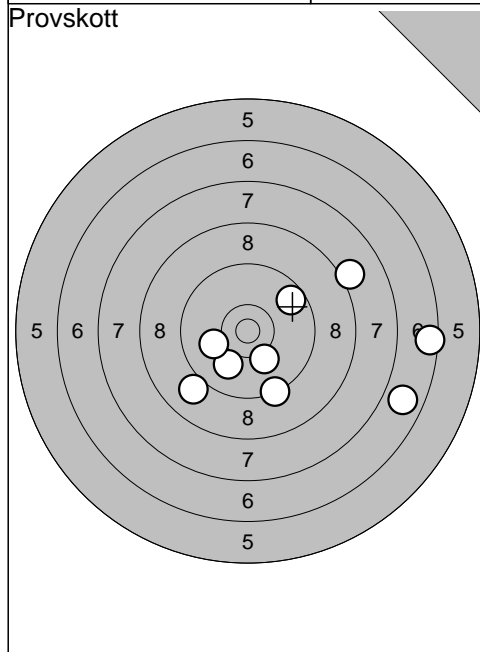

1: 0,0	↑
2: 6,5	→
3: 9,3	↓
4: 10,0	↓
5: 9,0	↓
6: 10,1	↓
7: 8,1	→
8: 10,1	←
9: 9,7	↗
10: 6,8	→
<hr/>	
Serie	77,0
Totalt	0,0

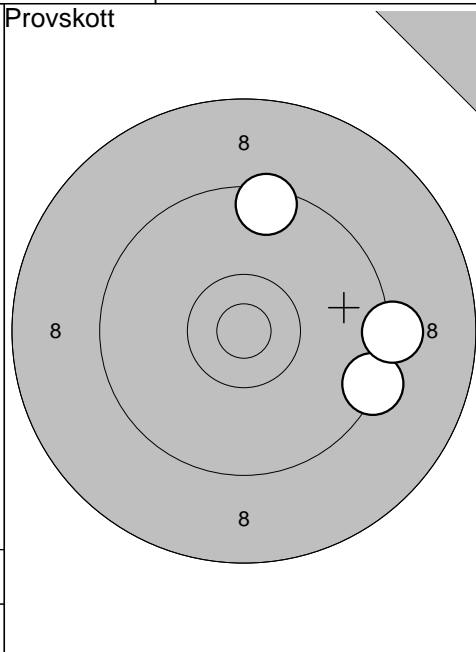

11: 9,5	↑
12: 9,4	→
13: 9,3	→
<hr/>	
Serie	27,0
Totalt	0,0

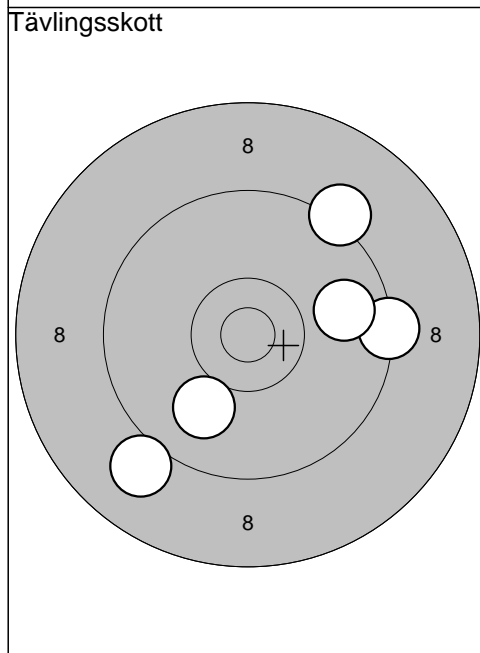

1: 9,2	↗
2: 9,3	→
3: 9,8	→
4: 9,0	↓
5: 10,0	↓
<hr/>	
Serie	46,0
Totalt	46,0

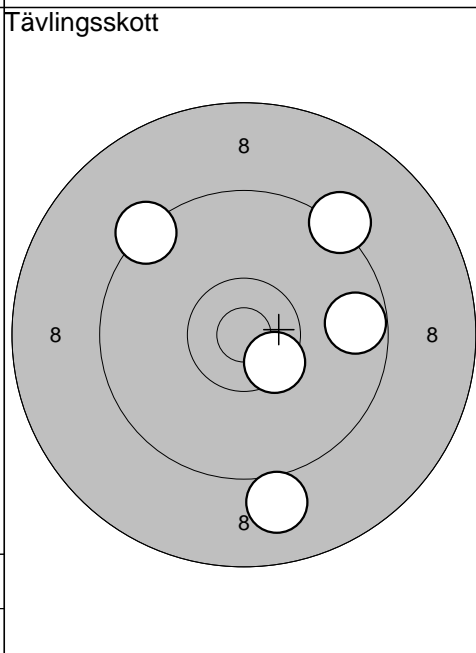

6: 10,5*	↘
7: 9,3	↗
8: 9,0	↓
9: 9,7	→
10: 9,3	↗
<hr/>	
Serie	46,0
Totalt	92,0

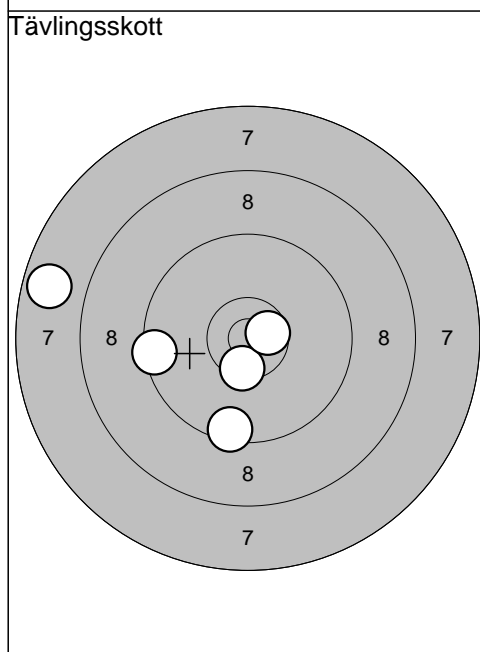

11: 9,5	↓
12: 10,5*	↓
13: 10,6*	→
14: 9,5	←
15: 7,7	←
<hr/>	
Serie	45,0
Totalt	137,0

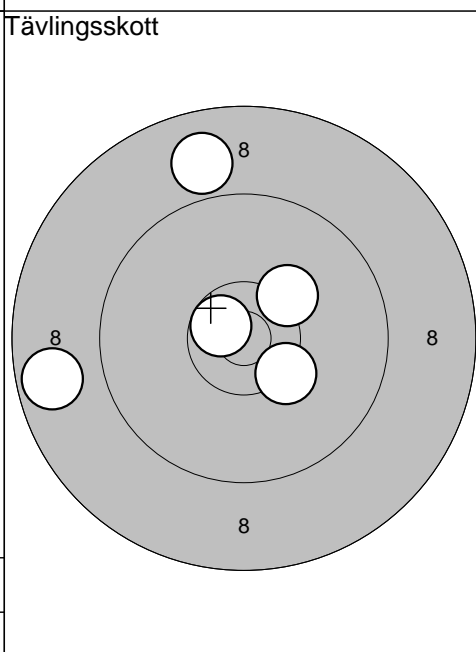

16: 10,7*	↖
17: 8,9	↑
18: 10,3*	↘
19: 8,7	←
20: 10,3	↗
<hr/>	
Serie	46,0
Totalt	183,0



Vännäs

2009-07-16

Tavelträffen 2009

Ramselefors SKF

Provs-kott

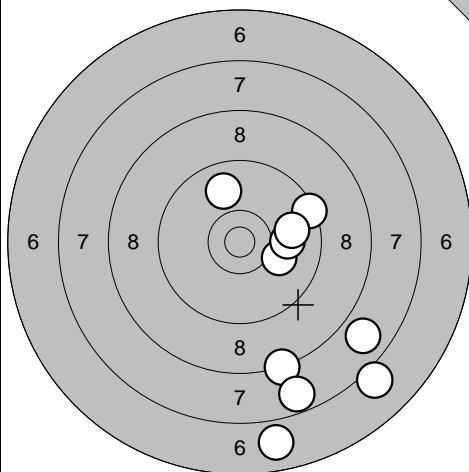

- 1: 10,1 →
- 2: 6,9 ↓
- 3: 7,1 ↓
- 4: 9,4 →
- 5: 10,0 →
- 6: 9,9 →
- 7: 9,9 ↑
- 8: 7,8 ↓
- 9: 8,3 ↓
- 10: 7,7 ↓

Serie 82,0  
Totalt 0,0

Provs-kott

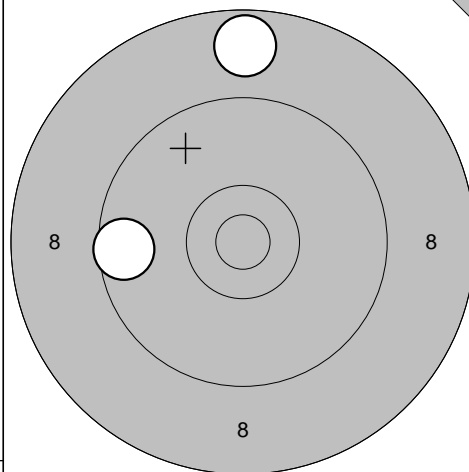

- 11: 8,7 ↑
- 12: 9,6 ←

Serie 17,0  
Totalt 0,0

Tävlingsskott

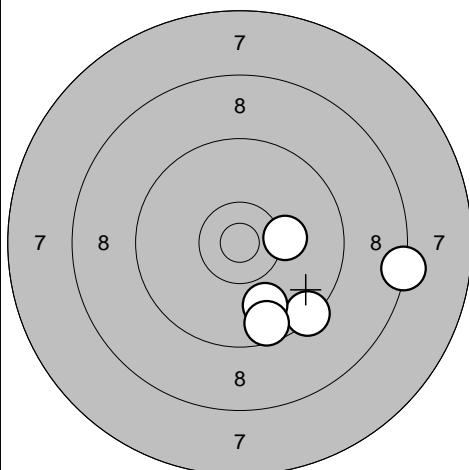

- 1: 8,3 →
- 2: 10,2 →
- 3: 9,4 ↓
- 4: 9,9 ↓
- 5: 9,6 ↓

Serie 45,0  
Totalt 45,0

Tävlingsskott

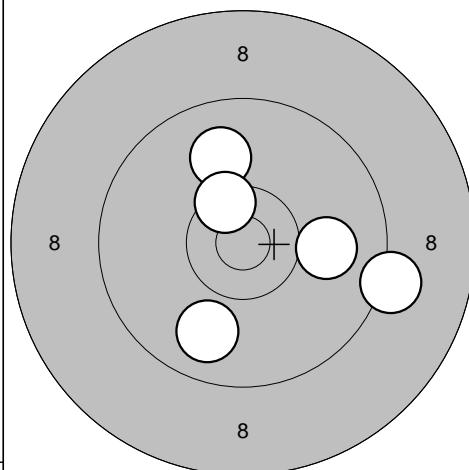

- 6: 10,0 ↑
- 7: 10,0 →
- 8: 9,9 ↓
- 9: 9,2 →
- 10: 10,5\* ↑

Serie 48,0  
Totalt 93,0

Tävlingsskott

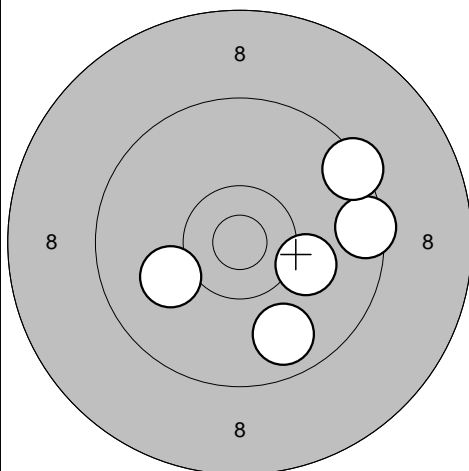

- 11: 10,1 ←
- 12: 9,8 ↓
- 13: 10,1 →
- 14: 9,5 →
- 15: 9,4 →

Serie 47,0  
Totalt 140,0

Tävlingsskott

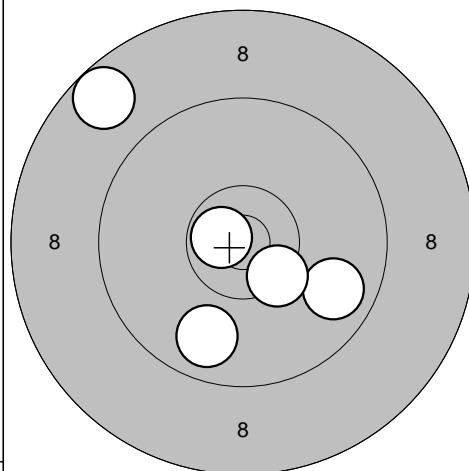

- 16: 10,7\* ←
- 17: 9,8 →
- 18: 10,4\* ↓
- 19: 9,8 ↓
- 20: 8,7 ↑

Serie 46,0  
Totalt 186,0

Ramselefors

2009-07-16

Tavelträffen 2009

Ramselefors SKF

Provskott

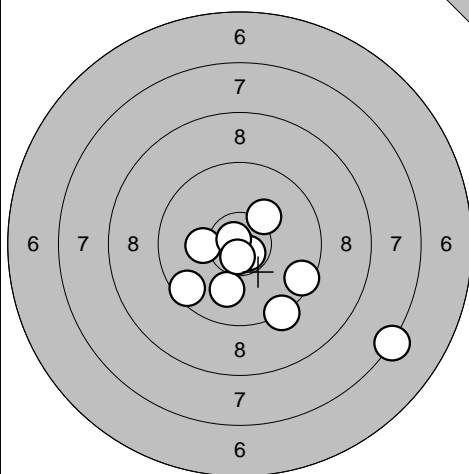

1: 9,3 ↘  
 2: 10,2 ↗  
 3: 10,7\* ↘  
 4: 10,2 ←  
 5: 9,6 ↙  
 6: 10,0 ↘  
 7: 9,5 ↗  
 8: 10,8\* ↗  
 9: 10,7\* ↘  
 10: 7,3 ↘

Serie 94,0

Totalt 0,0

Provskott

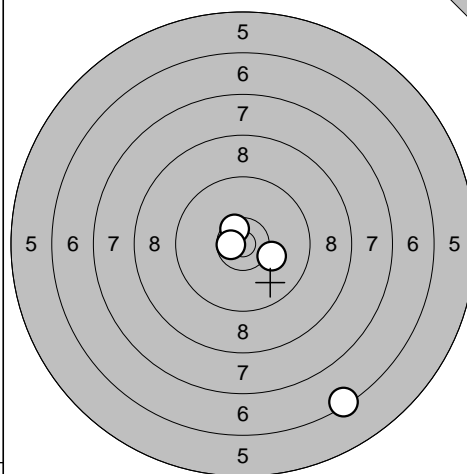

11: 6,4 ↘  
 12: 10,5\* ↗  
 13: 10,7\* ←  
 14: 10,2 ↗

Serie 36,0

Totalt 0,0

Tävlingsskott

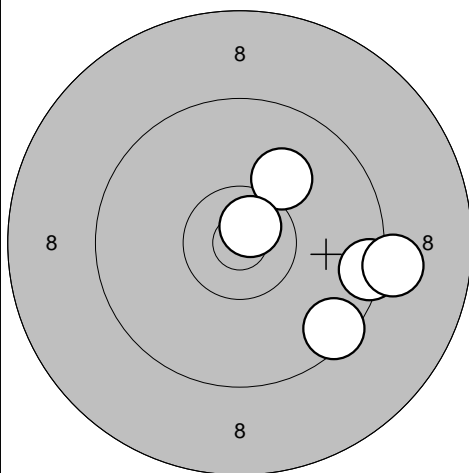

1: 10,1 ↗  
 2: 9,4 →  
 3: 10,7\* ↗  
 4: 9,2 →  
 5: 9,5 ↘

Serie 47,0

Totalt 47,0

Tävlingsskott

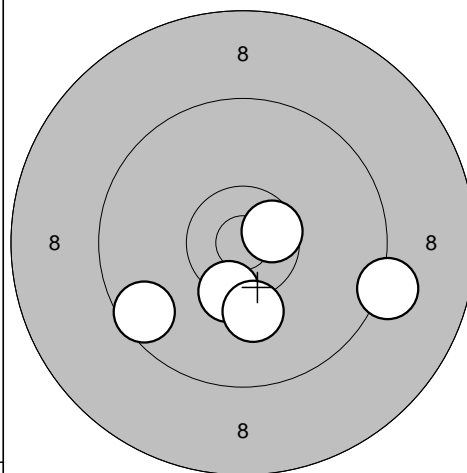

6: 9,6 ↙  
 7: 10,4\* ↘  
 8: 10,2 ↘  
 9: 9,2 →  
 10: 10,6\* →

Serie 48,0

Totalt 95,0

Tävlingsskott

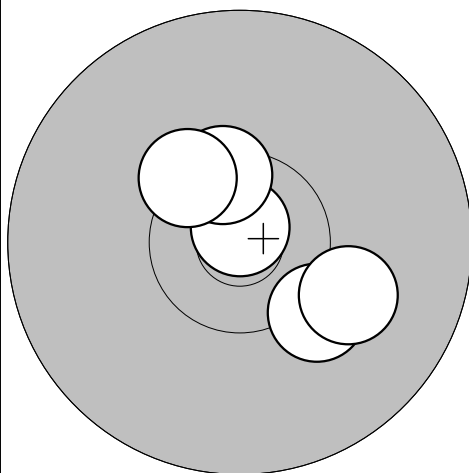

11: 10,8\* ↑  
 12: 10,5\* ↑  
 13: 10,4\* ↗  
 14: 10,2 ↘  
 15: 10,1 ↘

Serie 50,0

Totalt 145,0

Tävlingsskott

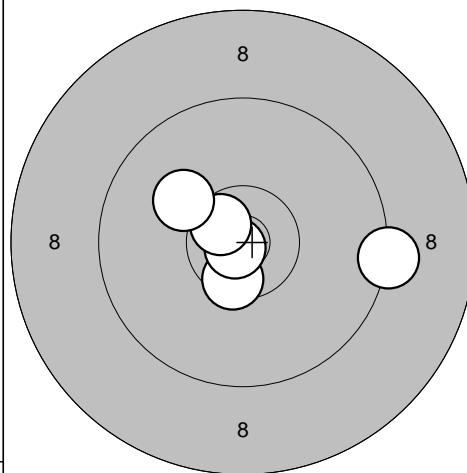

16: 9,3 →  
 17: 10,5\* ↘  
 18: 10,8\* ↙  
 19: 10,6\* ↙  
 20: 10,1 ↗

Serie 49,0

Totalt 194,0

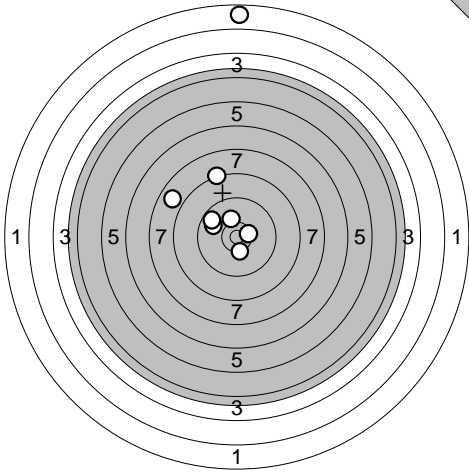
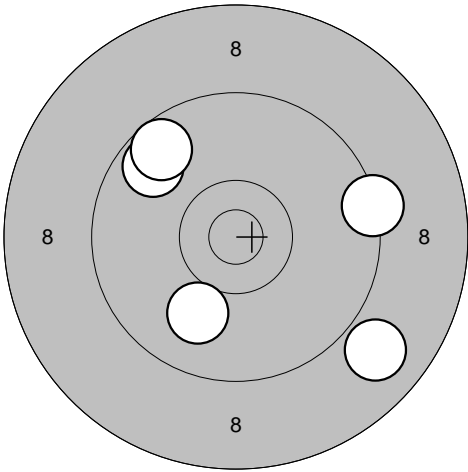
<b>Provs-kott</b> 	<b>Tävlingsskott</b> 	
1: 1,7 ↑ 2: 8,3 ↑ 3: 7,9 ↖ 4: 9,9 ↖ 5: 10,3* ↓ 6: 9,7 ↖ 7: 10,2 ↑ 8: 10,4* →	1: 8,9 ↘ 2: 9,3 → 3: 9,7 ↖ 4: 10,0 ↓ 5: 9,6 ↖	
Serie 64,0	Serie 45,0	
Totalt 0,0	Totalt 45,0	

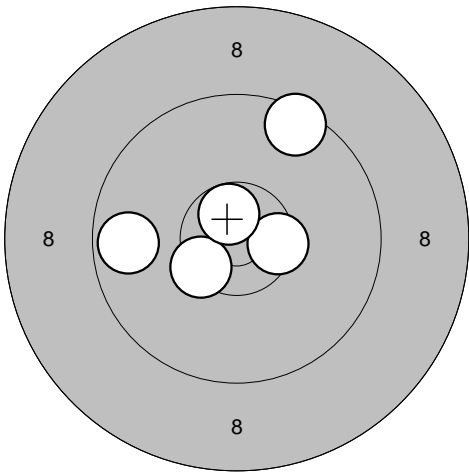
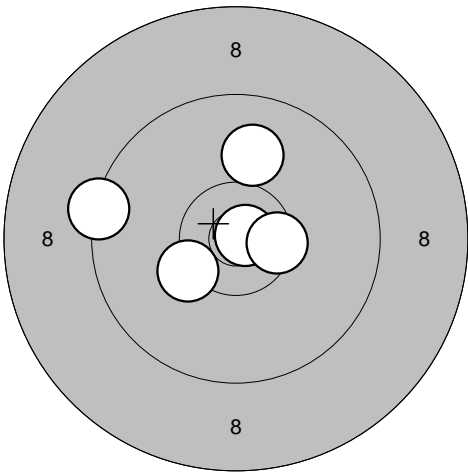
<b>Tävlingsskott</b> 	<b>Tävlingsskott</b> 	
6: 10,5* → 7: 9,5 ↑ 8: 10,4* ↖ 9: 10,7* ↑ 10: 9,7 ←	11: 10,0 ↑ 12: 10,8* → 13: 10,5* → 14: 10,3* ↖ 15: 9,4 ←	
Serie 48,0	Serie 49,0	
Totalt 93,0	Totalt 142,0	

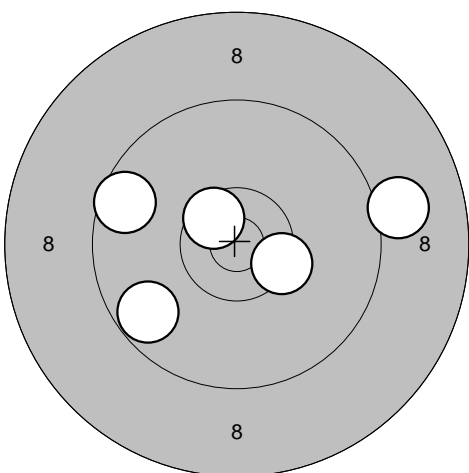
<b>Tävlingsskott</b> 		
16: 10,6* ↖ 17: 9,1 → 18: 9,7 ↖ 19: 9,6 ↖ 20: 10,4* →		
Serie 47,0		
Totalt 189,0		

Ramselefors

2009-07-16

Tavelträffen 2009

Ramselefors SKF

Provs-kott

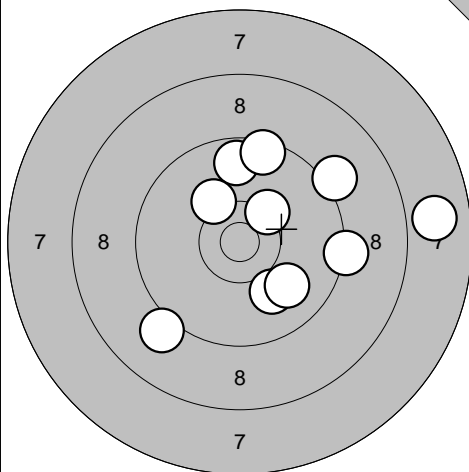

- 1: 7,9 →
- 2: 9,7 ↑
- 3: 9,1 ↗
- 4: 9,5 ↑
- 5: 10,3\* ↗
- 6: 9,3 →
- 7: 9,1 ↙
- 8: 10,2 ↑
- 9: 10,0 ↘
- 10: 9,9 ↘

Serie 91,0

Totalt 0,0

Provs-kott

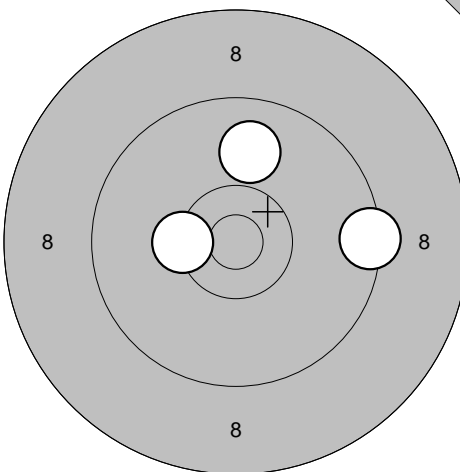

- 11: 9,9 ↑
- 12: 10,3\* ←
- 13: 9,4 →

Serie 28,0

Totalt 0,0

Tävlingsskott

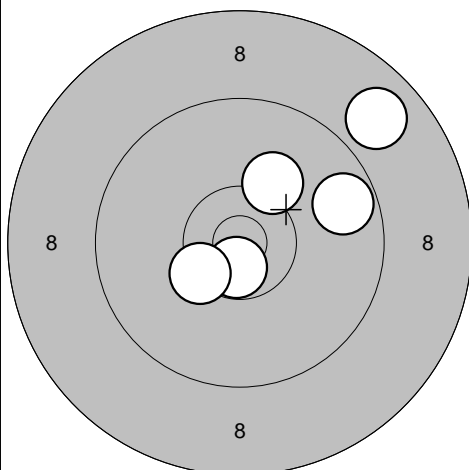

- 1: 10,7\* ↓
- 2: 10,2 ↑
- 3: 9,7 →
- 4: 8,8 ↗
- 5: 10,4\* ↙

Serie 47,0

Totalt 47,0

Tävlingsskott

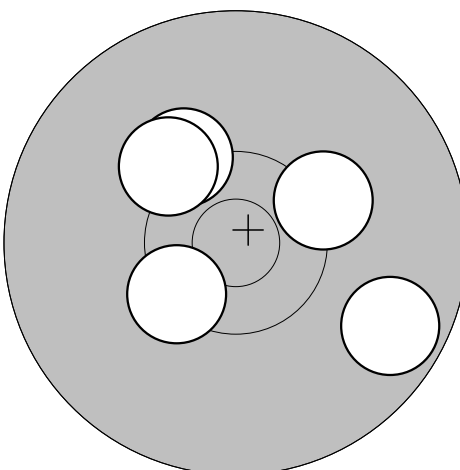

- 6: 10,3 ↗
- 7: 9,7 ↘
- 8: 10,4\* ↙
- 9: 10,2 ↑
- 10: 10,2 ↗

Serie 49,0

Totalt 96,0

Tävlingsskott

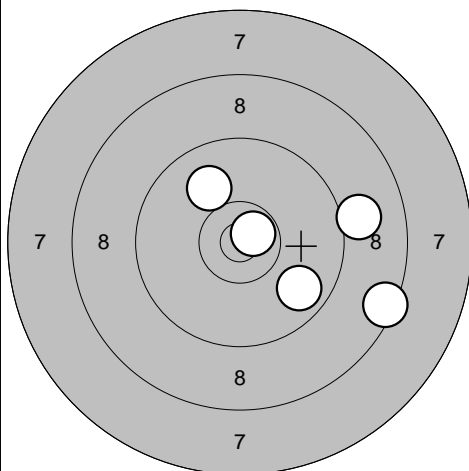

- 11: 9,0 →
- 12: 8,4 →
- 13: 9,8 ↘
- 14: 10,7\* ↗
- 15: 10,0 ↑

Serie 46,0

Totalt 142,0

Tävlingsskott

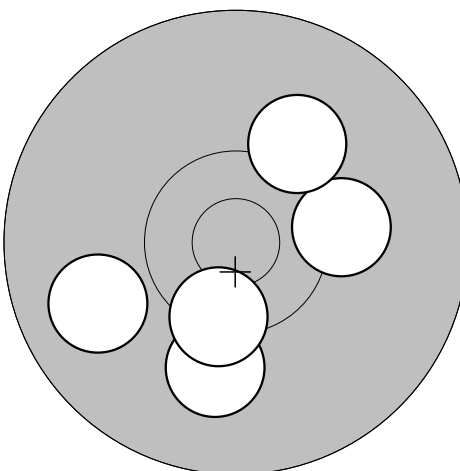

- 16: 10,2 →
- 17: 10,0 ↓
- 18: 10,4\* ↓
- 19: 9,9 ←
- 20: 10,1 ↗

Serie 49,0

Totalt 191,0

Ramselefors

2009-07-16

Tavelträffen 2009

Ramselefors SKF

Provs-kott

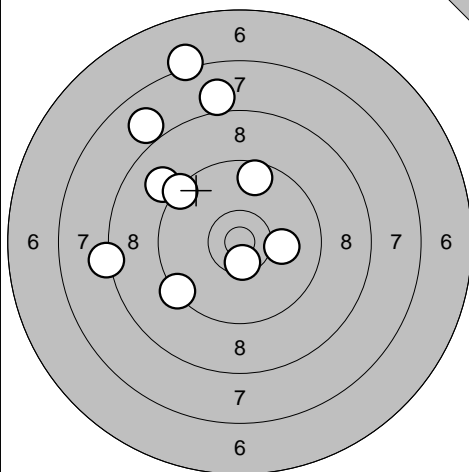

- 1: 8,0 ↗
- 2: 7,2 ↑
- 3: 9,0 ↗
- 4: 8,0 ↑
- 5: 9,6 ↑
- 6: 9,4 ↙
- 7: 9,4 ↗
- 8: 8,3 ←
- 9: 10,1 →
- 10: 10,5\* ↓

Serie	87,0
Totalt	0,0

Tävlingsskott

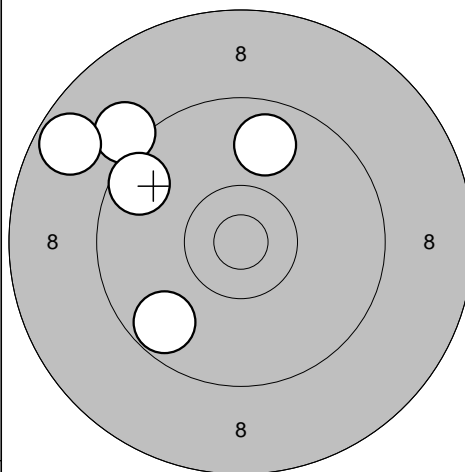

- 1: 9,1 ↗
- 2: 9,6 ↗
- 3: 9,8 ↑
- 4: 9,7 ↙
- 5: 8,7 ↗

Serie	44,0
Totalt	44,0

Tävlingsskott

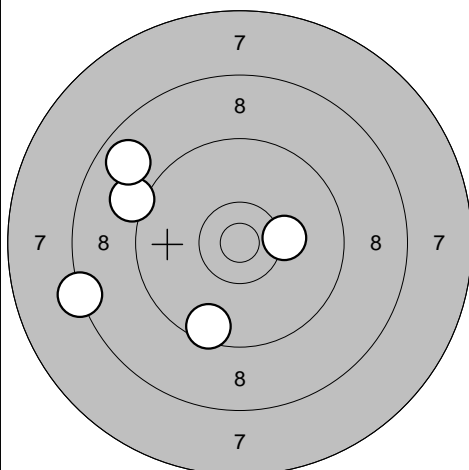

- 6: 9,1 ↗
- 7: 8,8 ↗
- 8: 10,2 →
- 9: 8,3 ←
- 10: 9,5 ↓

Serie	44,0
Totalt	88,0

Tävlingsskott

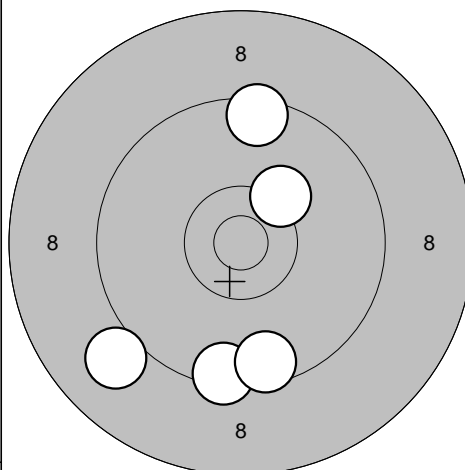

- 11: 9,5 ↑
- 12: 10,3 ↗
- 13: 9,4 ↓
- 14: 9,0 ↙
- 15: 9,6 ↓

Serie	46,0
Totalt	134,0

Tävlingsskott

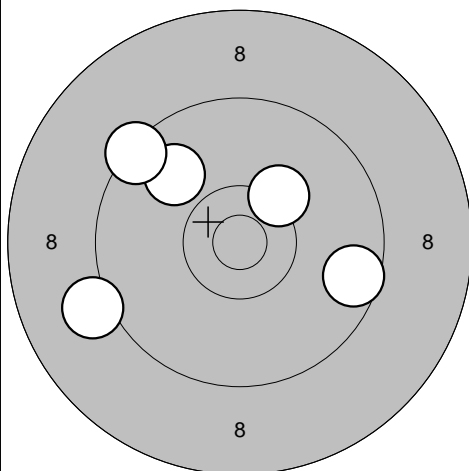

- 16: 9,1 ←
- 17: 9,9 ↗
- 18: 9,4 ↗
- 19: 10,3 ↗
- 20: 9,6 →

Serie	46,0
Totalt	180,0

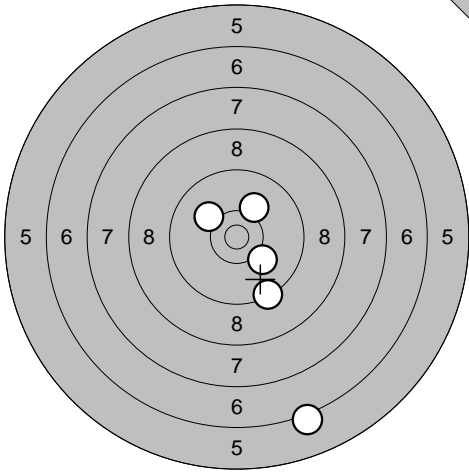
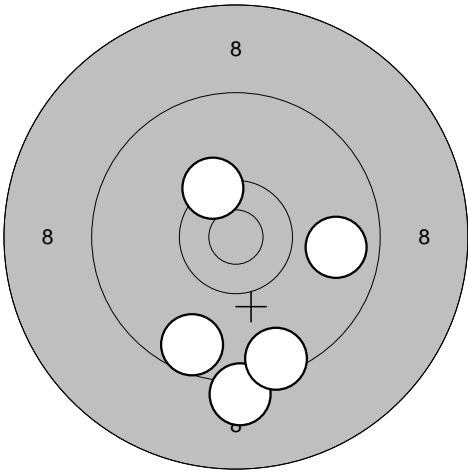
<b>Provs-kott</b> 	1: 6,2 ↘ 2: 9,4 ↘ 3: 10,1 ↗ 4: 10,1 ↘ 5: 10,1 ↗	<b>Tävlingsskott</b> 	1: 10,3* ↗ 2: 9,6 ↘ 3: 9,2 ↘ 4: 9,8 → 5: 9,5 ↘
Serie 45,0	Totalt 0,0	Serie 46,0	Totalt 46,0

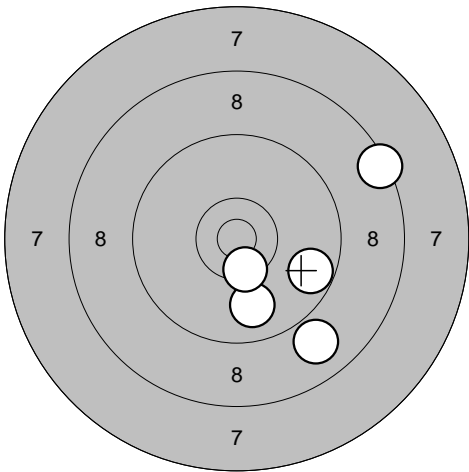
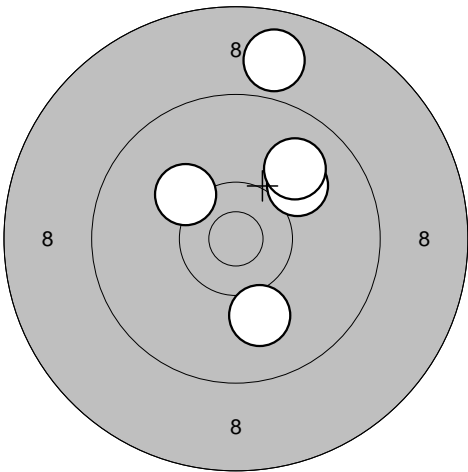
<b>Tävlingsskott</b> 	6: 9,9 ↘ 7: 8,9 ↘ 8: 8,4 → 9: 9,7 → 10: 10,4* ↘	<b>Tävlingsskott</b> 	11: 8,9 ↑ 12: 10,0 ↘ 13: 10,0 ↗ 14: 10,2 ↖ 15: 9,9 ↗
Serie 44,0	Totalt 90,0	Serie 47,0	Totalt 137,0

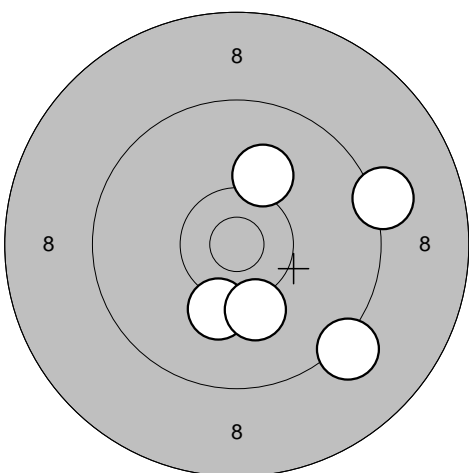
<b>Tävlingsskott</b> 	16: 9,2 ↘ 17: 10,2 ↘ 18: 10,1 ↗ 19: 10,2 ↘ 20: 9,2 →		
Serie 48,0	Totalt 185,0		

2009-07-16

Tavelträffen 2009

Ramselefors SKF

Provsjott

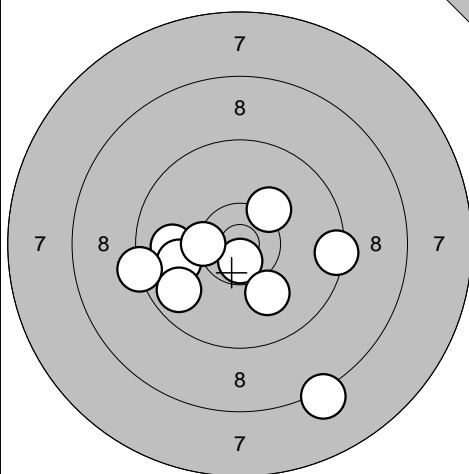

1: 8,2 ↘  
 2: 9,9 ←  
 3: 10,0 ←  
 4: 10,7\* ↓  
 5: 10,4\* ←  
 6: 9,8 ↙  
 7: 10,1 ↓  
 8: 9,4 →  
 9: 10,2 ↗  
 10: 9,3 ←

Serie 94,0

Totalt 0,0

Tävlingssjott

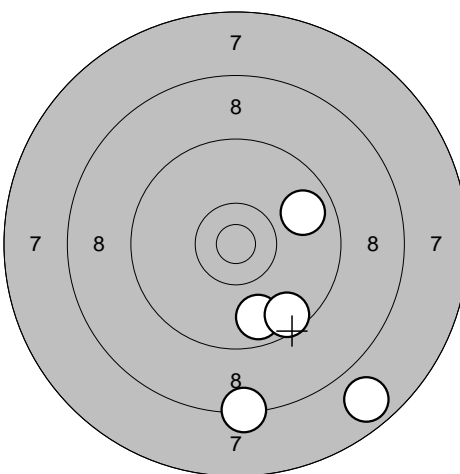

1: 9,8 ↘  
 2: 8,3 ↓  
 3: 9,6 ↘  
 4: 9,8 ↗  
 5: 7,8 ↘

Serie 42,0

Totalt 42,0

Tävlingssjott

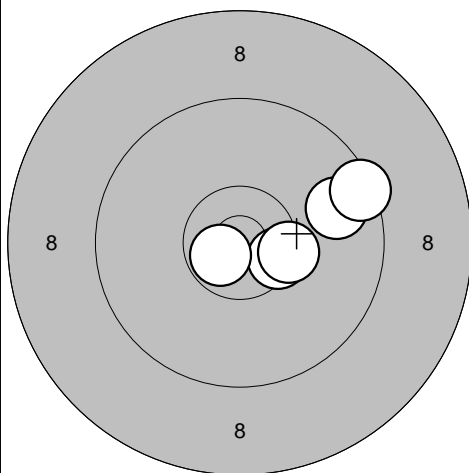

6: 10,5\* ↗  
 7: 9,8 →  
 8: 9,4 →  
 9: 10,4\* →  
 10: 10,7\* ↙

Serie 48,0

Totalt 90,0

Tävlingssjott

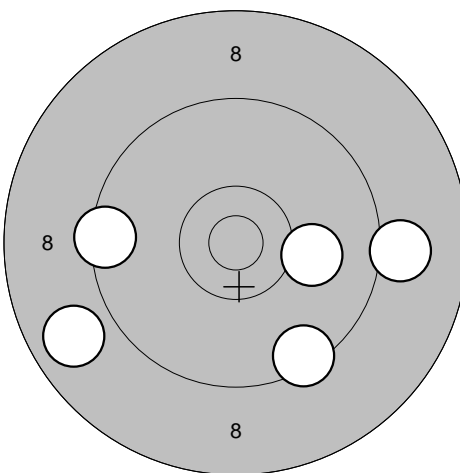

11: 10,1 →  
 12: 8,8 ↙  
 13: 9,4 ↓  
 14: 9,1 →  
 15: 9,5 ←

Serie 45,0

Totalt 135,0

Tävlingssjott

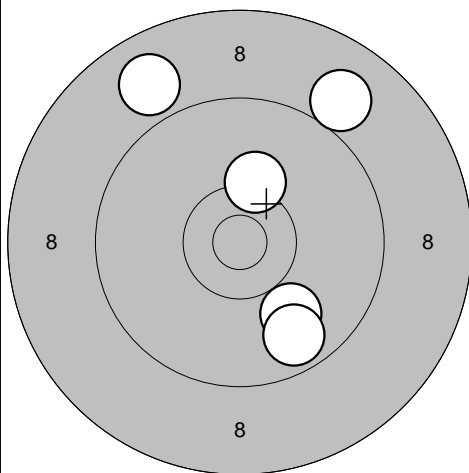

16: 8,9 ↗  
 17: 9,9 ↓  
 18: 9,7 ↓  
 19: 9,0 ↗  
 20: 10,2 ↗

Serie 45,0

Totalt 180,0

2009-07-16

Tavelträffen 2009

Ramselefors SKF

Provskott

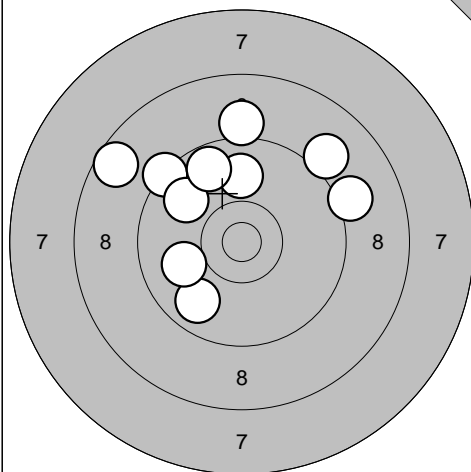

1: 9,1 →  
 2: 9,1 ↗  
 3: 9,1 ↑  
 4: 9,4 ↖  
 5: 9,9 ↑  
 6: 8,6 ↖  
 7: 9,9 ↗  
 8: 9,8 ↓  
 9: 10,0 ←  
 10: 9,7 ↗

Serie 90,0

Totalt 0,0

Provskott

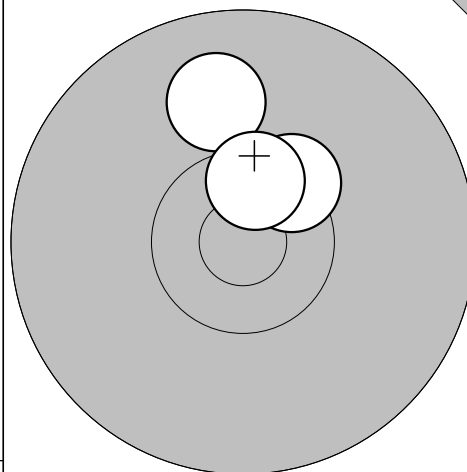

11: 9,9 ↑  
 12: 10,4\* ↗  
 13: 10,5\* ↑

Serie 29,0

Totalt 0,0

Tävlingsskott

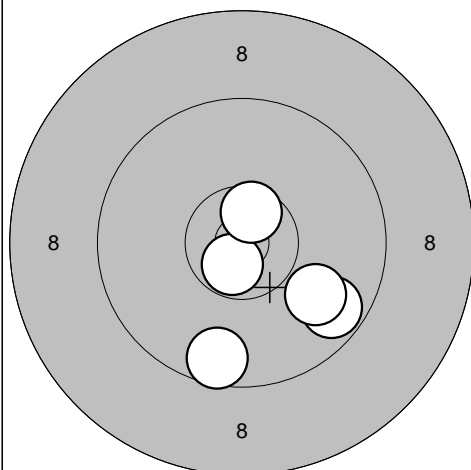

1: 10,7\* ↓  
 2: 9,7 ↘  
 3: 9,6 ↓  
 4: 10,6\* ↑  
 5: 9,9 ↘

Serie 47,0

Totalt 47,0

Tävlingsskott

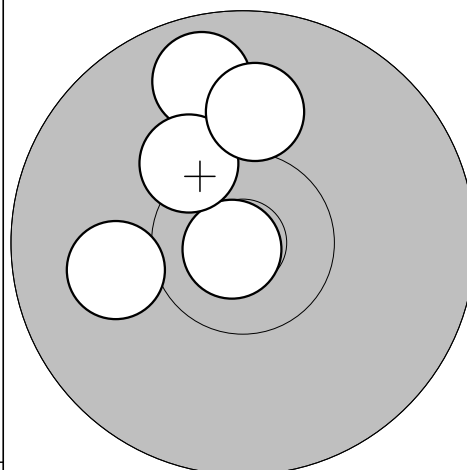

6: 10,0 ←  
 7: 10,9\* ↖  
 8: 9,8 ↑  
 9: 10,3 ↗  
 10: 10,0 ↑

Serie 49,0

Totalt 96,0

Tävlingsskott

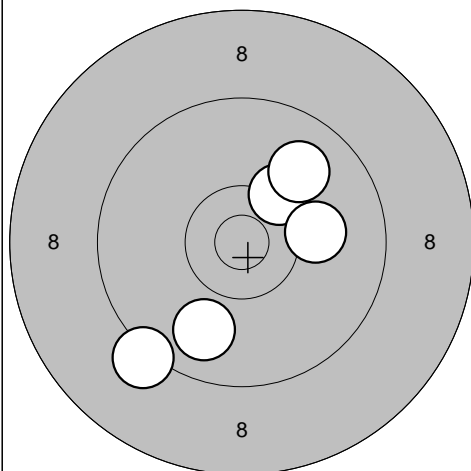

11: 10,3 ↗  
 12: 9,2 ↓  
 13: 9,9 ↓  
 14: 10,1 →  
 15: 9,9 ↗

Serie 47,0

Totalt 143,0

Tävlingsskott

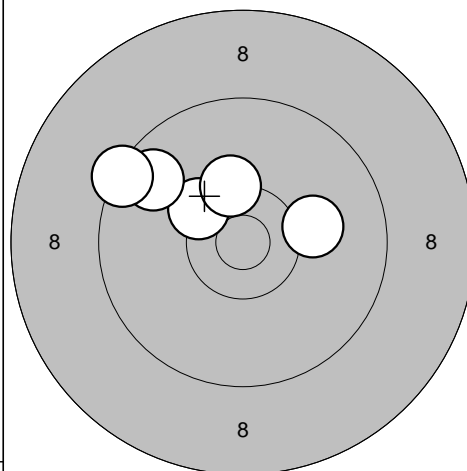

16: 10,1 →  
 17: 10,3\* ↖  
 18: 10,3\* ↑  
 19: 9,7 ↖  
 20: 9,4 ↖

Serie 48,0

Totalt 191,0



Ale

2009-07-16	Tavelträffen 2009	Ramselefors SKF
------------	-------------------	-----------------

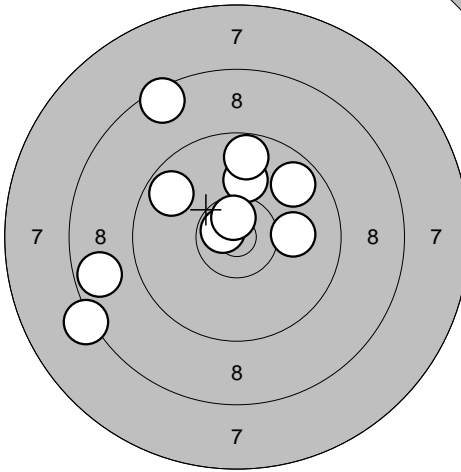
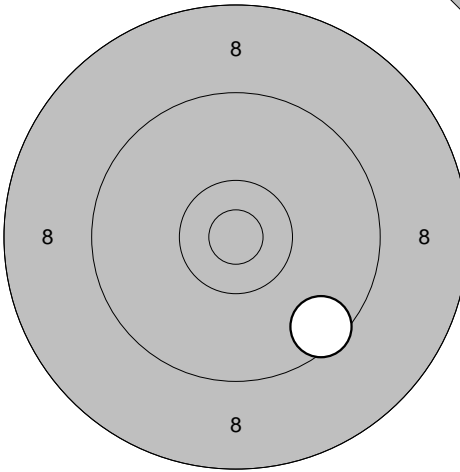
<p>Provskott</p> 	<p>1: 8,2 ↙                  2: 8,7 ←                  3: 8,5 ↗                  4: 10,0 ↑                  5: 10,7* ↙                  6: 9,7 ↑                  7: 9,7 ↗                  8: 9,7 ↗                  9: 10,6* ↑                  10: 10,1 →</p> <table border="1" style="width:100%; border-collapse: collapse;"> <tr><td>Serie</td><td style="text-align: right;">91,0</td></tr> <tr><td>Totalt</td><td style="text-align: right;">0,0</td></tr> </table>	Serie	91,0	Totalt	0,0	<p>Provskott</p>  <p style="text-align: right;">11: 9,5 ↘</p> <table border="1" style="width:100%; border-collapse: collapse;"> <tr><td>Serie</td><td style="text-align: right;">9,0</td></tr> <tr><td>Totalt</td><td style="text-align: right;">0,0</td></tr> </table>	Serie	9,0	Totalt	0,0
Serie	91,0									
Totalt	0,0									
Serie	9,0									
Totalt	0,0									

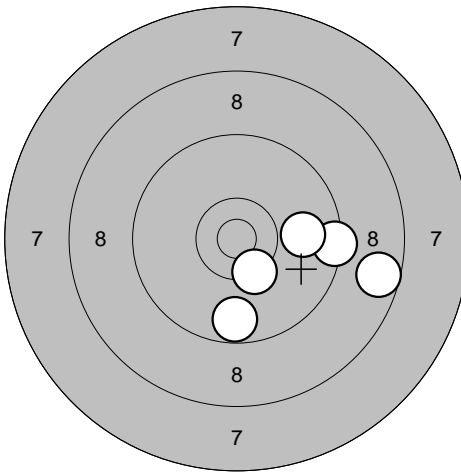
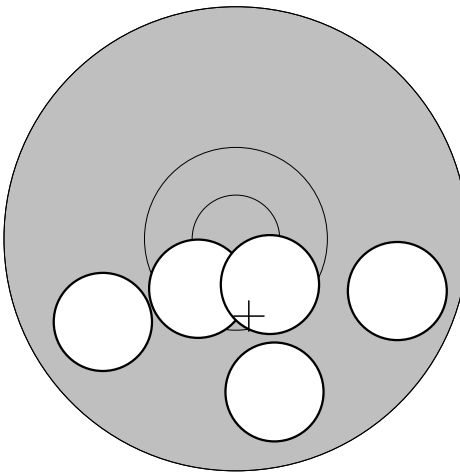
<p>Tävlingsskott</p> 	<p>1: 9,7 ↓                  2: 8,6 →                  3: 9,4 →                  4: 9,9 →                  5: 10,4* ↘</p> <table border="1" style="width:100%; border-collapse: collapse;"> <tr><td>Serie</td><td style="text-align: right;">45,0</td></tr> <tr><td>Totalt</td><td style="text-align: right;">45,0</td></tr> </table>	Serie	45,0	Totalt	45,0	<p>Tävlingsskott</p>  <p style="text-align: right;">6: 9,8 ↙                  7: 9,8 ↓                  8: 9,7 →                  9: 10,5* ↘                  10: 10,5* ↘</p> <table border="1" style="width:100%; border-collapse: collapse;"> <tr><td>Serie</td><td style="text-align: right;">47,0</td></tr> <tr><td>Totalt</td><td style="text-align: right;">92,0</td></tr> </table>	Serie	47,0	Totalt	92,0
Serie	45,0									
Totalt	45,0									
Serie	47,0									
Totalt	92,0									

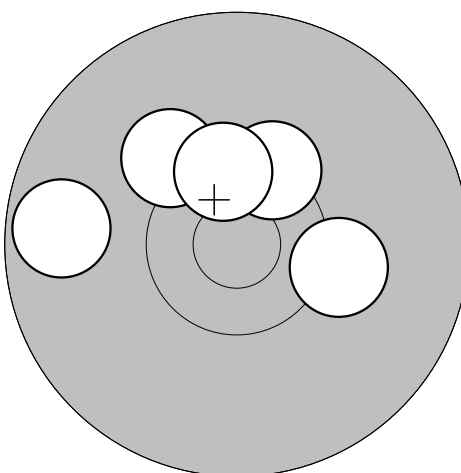
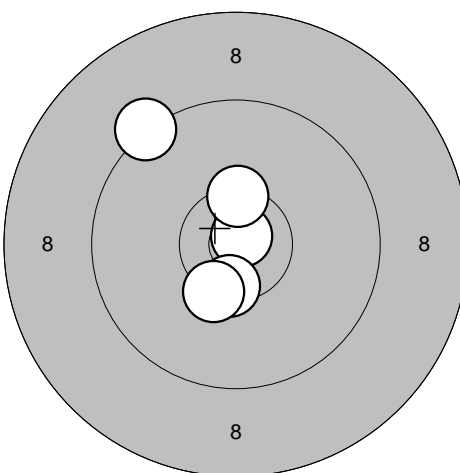
<p>Tävlingsskott</p> 	<p>11: 10,4* ↗                  12: 10,2 →                  13: 10,2 ↗                  14: 10,4* ↑                  15: 9,7 ←</p> <table border="1" style="width:100%; border-collapse: collapse;"> <tr><td>Serie</td><td style="text-align: right;">49,0</td></tr> <tr><td>Totalt</td><td style="text-align: right;">141,0</td></tr> </table>	Serie	49,0	Totalt	141,0	<p>Tävlingsskott</p>  <p style="text-align: right;">16: 9,3 ↖                  17: 10,8* ↗                  18: 10,4* ↑                  19: 10,5* ↓                  20: 10,4* ↘</p> <table border="1" style="width:100%; border-collapse: collapse;"> <tr><td>Serie</td><td style="text-align: right;">49,0</td></tr> <tr><td>Totalt</td><td style="text-align: right;">190,0</td></tr> </table>	Serie	49,0	Totalt	190,0
Serie	49,0									
Totalt	141,0									
Serie	49,0									
Totalt	190,0									

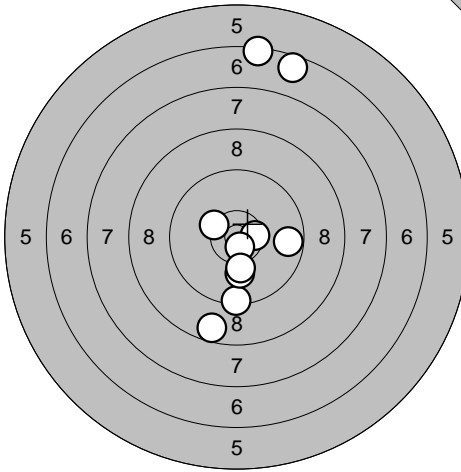
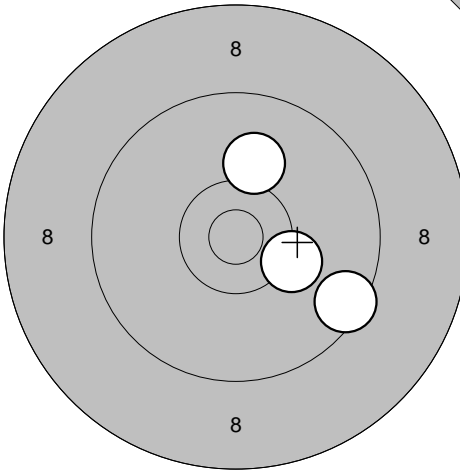
<p>Provskott</p> 	<p>1: 6,6 ↗</p> <p>2: 6,4 ↗</p> <p>3: 9,4 ↓</p> <p>4: 8,6 ↓</p> <p>5: 10,5* →</p> <p>6: 10,7* ↓</p> <p>7: 9,7 →</p> <p>8: 10,1 ↓</p> <p>9: 10,2 ↓</p> <p>10: 10,3* ↖</p> <table border="1" style="width:100%; border-collapse: collapse; margin-top: 10px;"> <tr><td>Serie</td><td style="text-align: right;">88,0</td></tr> <tr><td>Totalt</td><td style="text-align: right;">0,0</td></tr> </table>	Serie	88,0	Totalt	0,0	<p>Provskott</p>  <table border="1" style="width:100%; border-collapse: collapse; margin-top: 10px;"> <tr><td>11: 10,3 ↘</td></tr> <tr><td>12: 9,5 ↘</td></tr> <tr><td>13: 10,1 ↗</td></tr> <tr><td>Serie</td><td style="text-align: right;">29,0</td></tr> <tr><td>Totalt</td><td style="text-align: right;">0,0</td></tr> </table>	11: 10,3 ↘	12: 9,5 ↘	13: 10,1 ↗	Serie	29,0	Totalt	0,0
Serie	88,0												
Totalt	0,0												
11: 10,3 ↘													
12: 9,5 ↘													
13: 10,1 ↗													
Serie	29,0												
Totalt	0,0												

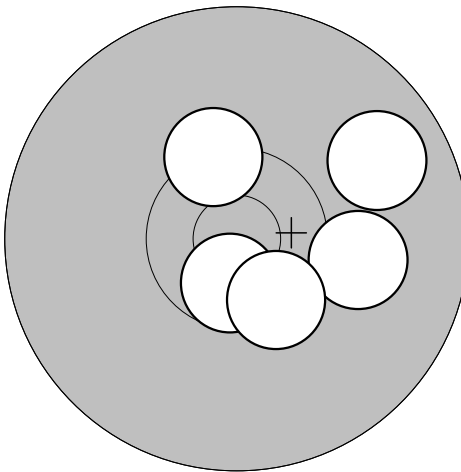
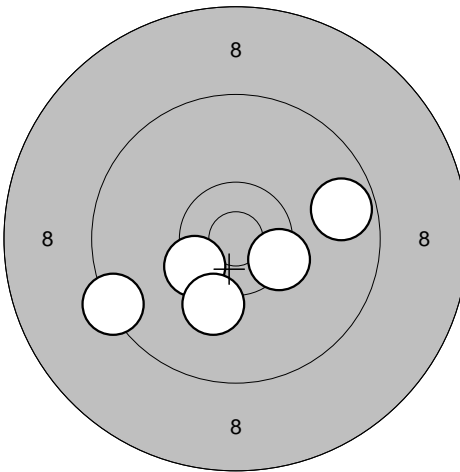
<p>Tävlingsskott</p>  <table border="1" style="width:100%; border-collapse: collapse; margin-top: 10px;"> <tr><td>Serie</td><td style="text-align: right;">49,0</td></tr> <tr><td>Totalt</td><td style="text-align: right;">49,0</td></tr> </table>	Serie	49,0	Totalt	49,0	<p>Tävlingsskott</p>  <table border="1" style="width:100%; border-collapse: collapse; margin-top: 10px;"> <tr><td>6: 10,4* ↘</td></tr> <tr><td>7: 10,4* ↙</td></tr> <tr><td>8: 9,4 ↙</td></tr> <tr><td>9: 9,7 →</td></tr> <tr><td>10: 10,2 ↓</td></tr> <tr><td>Serie</td><td style="text-align: right;">48,0</td></tr> <tr><td>Totalt</td><td style="text-align: right;">97,0</td></tr> </table>	6: 10,4* ↘	7: 10,4* ↙	8: 9,4 ↙	9: 9,7 →	10: 10,2 ↓	Serie	48,0	Totalt	97,0
Serie	49,0													
Totalt	49,0													
6: 10,4* ↘														
7: 10,4* ↙														
8: 9,4 ↙														
9: 9,7 →														
10: 10,2 ↓														
Serie	48,0													
Totalt	97,0													

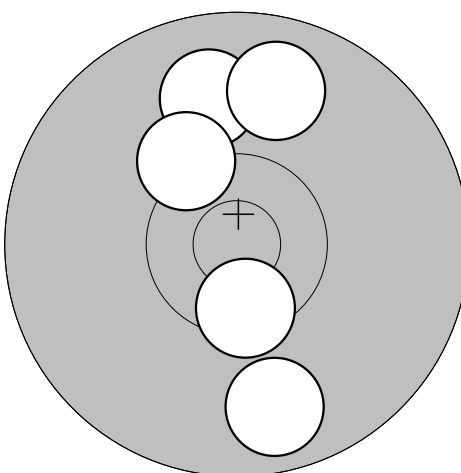
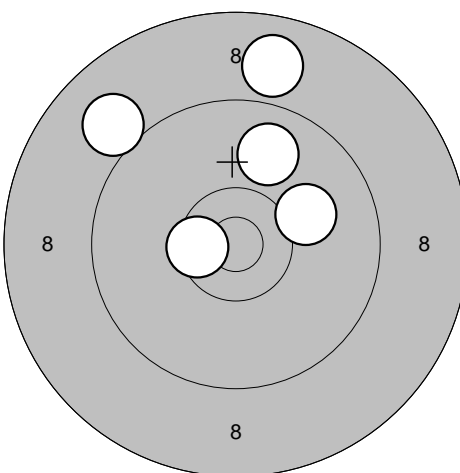
<p>Tävlingsskott</p>  <table border="1" style="width:100%; border-collapse: collapse; margin-top: 10px;"> <tr><td>Serie</td><td style="text-align: right;">47,0</td></tr> <tr><td>Totalt</td><td style="text-align: right;">144,0</td></tr> </table>	Serie	47,0	Totalt	144,0	<p>Tävlingsskott</p>  <table border="1" style="width:100%; border-collapse: collapse; margin-top: 10px;"> <tr><td>11: 9,8 ↓</td></tr> <tr><td>12: 9,9 ↗</td></tr> <tr><td>13: 10,5* ↓</td></tr> <tr><td>14: 10,3 ↗</td></tr> <tr><td>15: 9,8 ↗</td></tr> <tr><td>16: 9,0 ↖</td></tr> <tr><td>17: 8,9 ↗</td></tr> <tr><td>18: 10,5* ←</td></tr> <tr><td>19: 10,1 →</td></tr> <tr><td>20: 9,9 ↗</td></tr> <tr><td>Serie</td><td style="text-align: right;">46,0</td></tr> <tr><td>Totalt</td><td style="text-align: right;">190,0</td></tr> </table>	11: 9,8 ↓	12: 9,9 ↗	13: 10,5* ↓	14: 10,3 ↗	15: 9,8 ↗	16: 9,0 ↖	17: 8,9 ↗	18: 10,5* ←	19: 10,1 →	20: 9,9 ↗	Serie	46,0	Totalt	190,0
Serie	47,0																		
Totalt	144,0																		
11: 9,8 ↓																			
12: 9,9 ↗																			
13: 10,5* ↓																			
14: 10,3 ↗																			
15: 9,8 ↗																			
16: 9,0 ↖																			
17: 8,9 ↗																			
18: 10,5* ←																			
19: 10,1 →																			
20: 9,9 ↗																			
Serie	46,0																		
Totalt	190,0																		

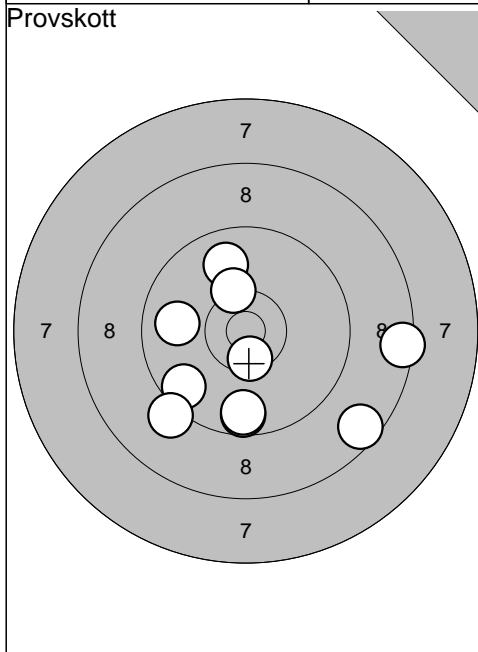

1: 8,5	→
2: 8,6	↘
3: 9,6	↓
4: 9,7	↓
5: 9,6	↙
6: 9,2	↙
7: 9,9	↑
8: 9,9	←
9: 10,5*	↓
10: 10,3*	↑
Serie	90,0
Totalt	0,0

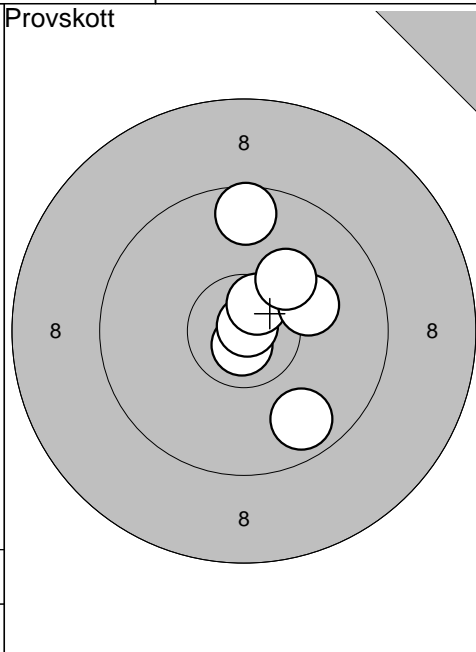

11: 10,8*	↓
12: 10,9*	↗
13: 10,6*	↗
14: 10,2	→
15: 10,2	↗
16: 9,6	↑
17: 9,7	↘
Serie	68,0
Totalt	0,0

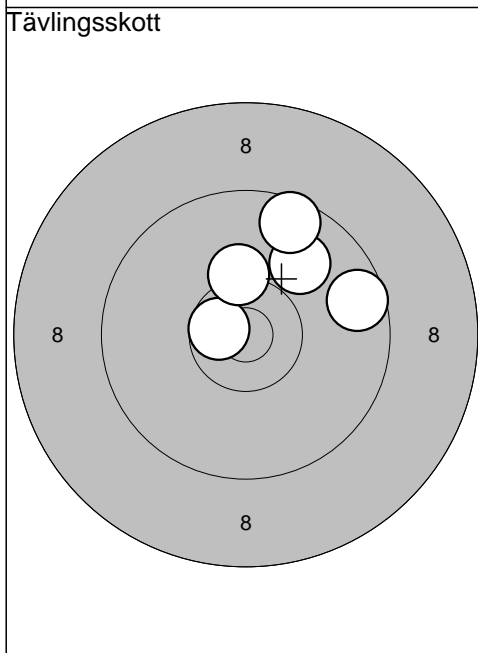

1: 9,9	↗
2: 9,6	→
3: 10,6*	←
4: 10,3	↑
5: 9,6	↗
Serie	47,0
Totalt	47,0

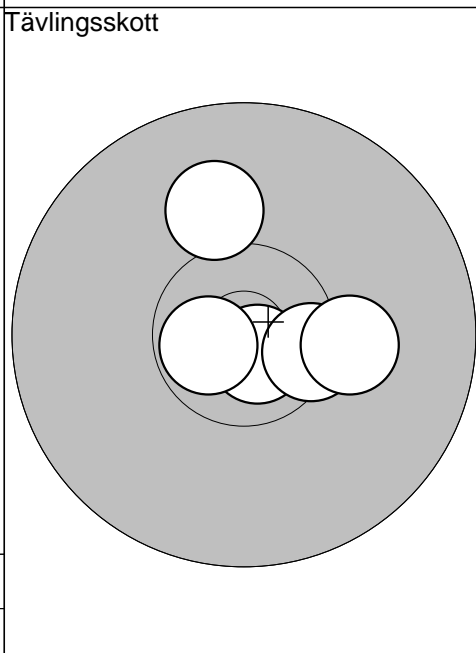

6: 10,0	↑
7: 10,8*	↘
8: 10,5*	→
9: 10,7*	←
10: 10,2	→
Serie	50,0
Totalt	97,0

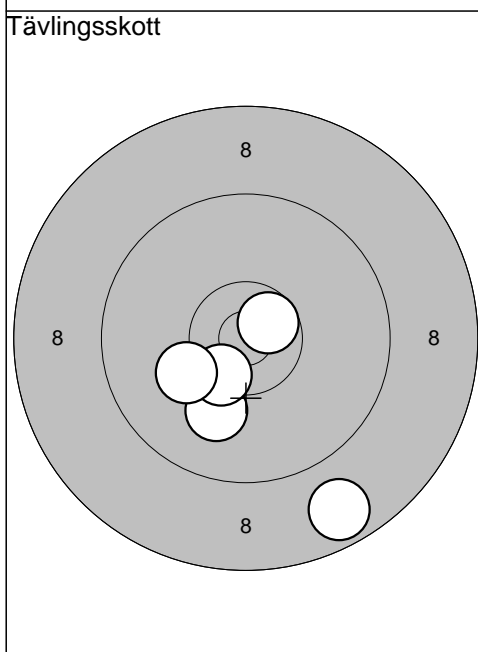

11: 10,1	↓
12: 10,4*	↘
13: 10,6*	↗
14: 10,2	↙
15: 8,7	↘
Serie	48,0
Totalt	145,0

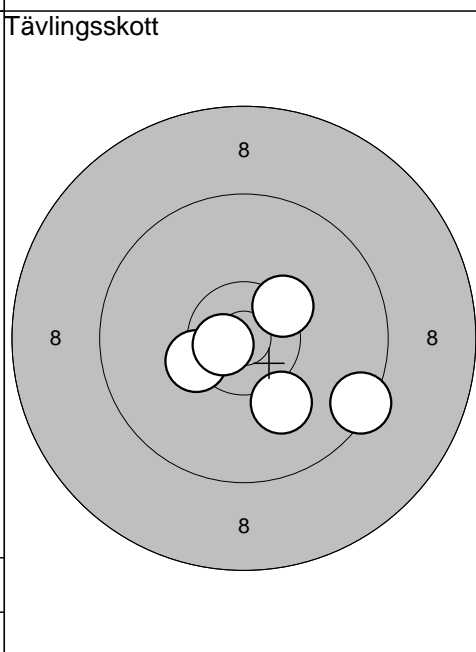

16: 10,4*	↗
17: 10,4*	↙
18: 9,4	↘
19: 10,7*	←
20: 10,1	↓
Serie	49,0
Totalt	194,0

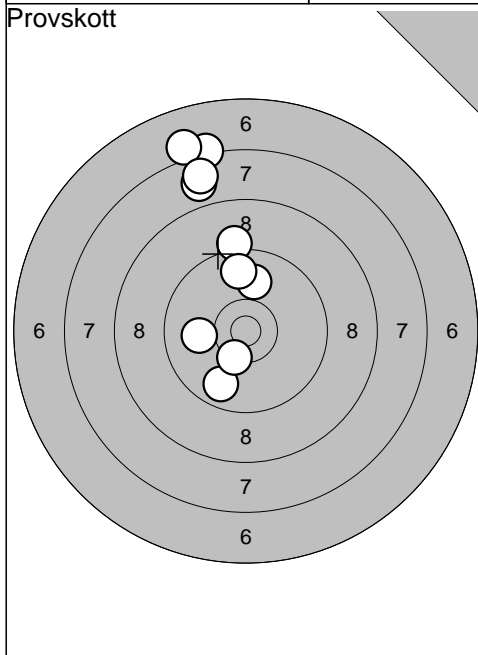

1: 7,3	↑
2: 7,1	↑
3: 7,9	↑
4: 7,7	↑
5: 9,2	↑
6: 9,8	↓
7: 10,0	←
8: 10,0	↑
9: 9,8	↑
10: 10,4*	↓
Serie	85,0
Totalt	0,0

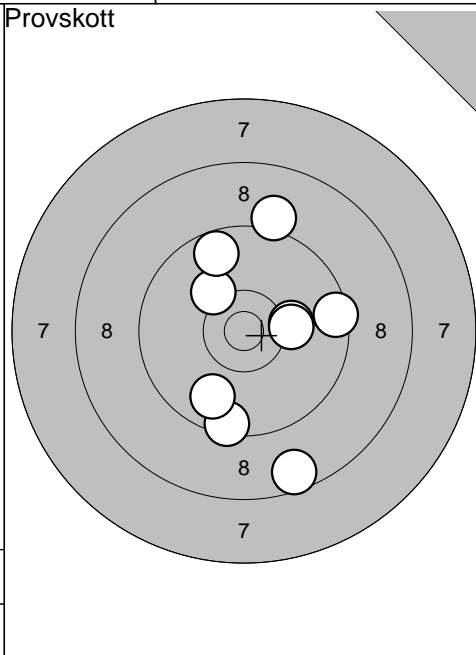

11: 10,2	→
12: 10,2	↖
13: 9,7	↑
14: 9,1	↑
15: 8,6	↓
16: 9,5	↓
17: 9,8	↓
18: 10,2	→
19: 9,5	→
Serie	83,0
Totalt	0,0

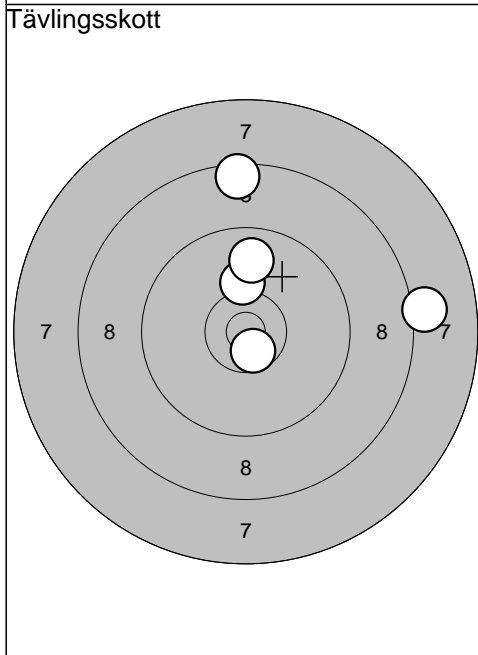

1: 8,5	↑
2: 8,1	→
3: 10,2	↑
4: 9,8	↑
5: 10,6*	↓
Serie	45,0
Totalt	45,0

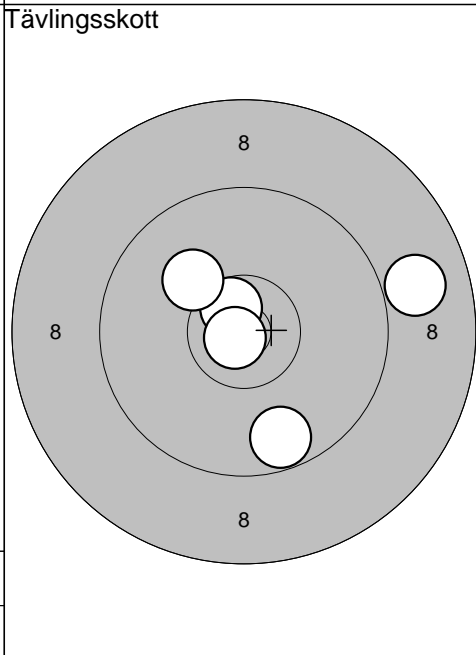

6: 10,6*	↑
7: 10,1	↖
8: 8,9	→
9: 10,8*	↙
10: 9,7	↓
Serie	47,0
Totalt	92,0

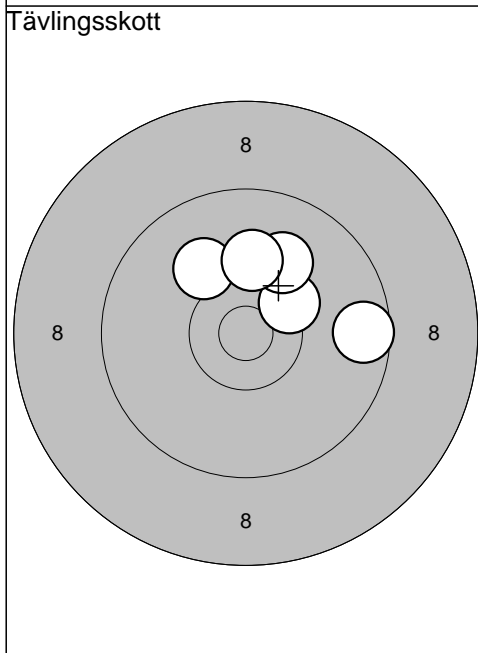

11: 9,6	→
12: 10,1	↖
13: 10,3*	↗
14: 10,0	↑
15: 10,1	↑
Serie	49,0
Totalt	141,0

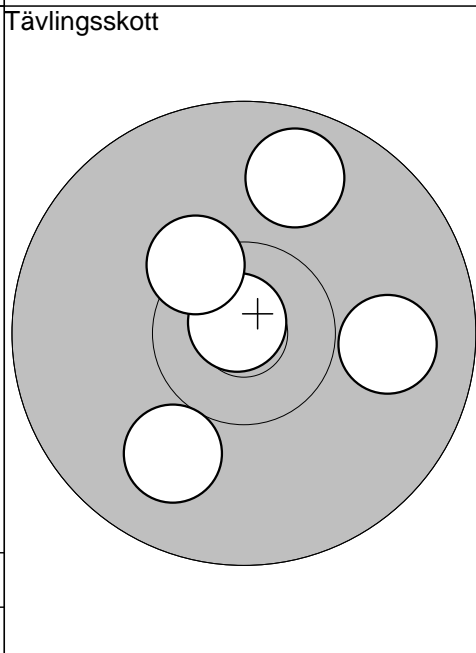

16: 9,8	↑
17: 10,9*	↖
18: 10,4*	↖
19: 10,0	↓
20: 9,9	→
Serie	48,0
Totalt	189,0

I 19 / A 9

2009-07-16

Tavelträffen 2009

Ramselefors SKF

Provskott

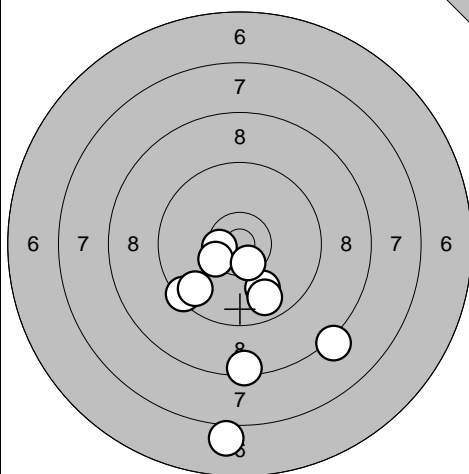

- 1: 8,5 ↓
- 2: 7,0 ↓
- 3: 9,4 ↙
- 4: 9,9 ↓
- 5: 9,8 ↓
- 6: 10,5\* ←
- 7: 10,4\* ↙
- 8: 9,7 ↙
- 9: 10,5\* ↓
- 10: 8,2 ↓

Serie 89,0

Totalt 0,0

Provskott

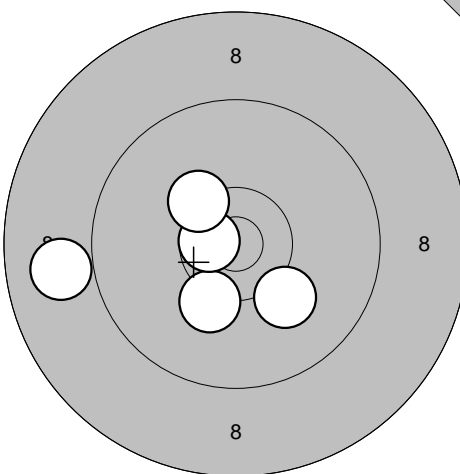

- 11: 10,2 ↓
- 12: 10,6\* ←
- 13: 10,1 ↓
- 14: 10,3\* ↗
- 15: 8,9 ←

Serie 48,0

Totalt 0,0

Tävlingsskott

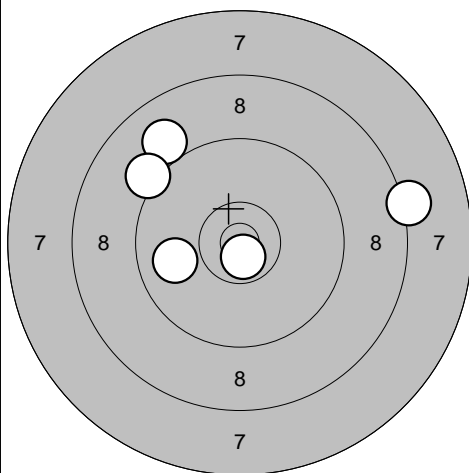

- 1: 8,2 →
- 2: 9,0 ↗
- 3: 10,7\* ↓
- 4: 9,2 ↗
- 5: 9,9 ←

Serie 45,0

Totalt 45,0

Tävlingsskott

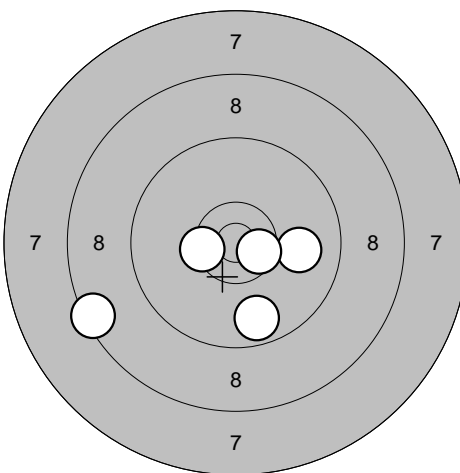

- 6: 9,9 →
- 7: 8,4 ↙
- 8: 10,4\* ←
- 9: 10,6\* →
- 10: 9,7 ↓

Serie 46,0

Totalt 91,0

Tävlingsskott

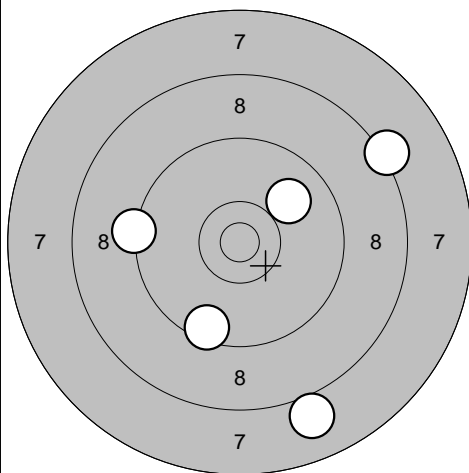

- 11: 8,0 ↓
- 12: 9,5 ↓
- 13: 9,3 ←
- 14: 8,2 ↗
- 15: 9,9 ↗

Serie 43,0

Totalt 134,0

Tävlingsskott

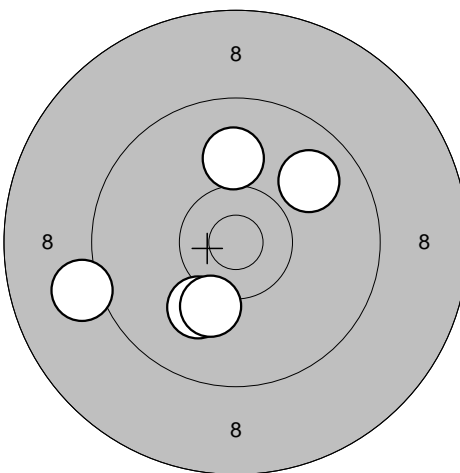

- 16: 10,0 ↑
- 17: 10,1 ↓
- 18: 9,9 ↗
- 19: 10,2 ↓
- 20: 9,1 ←

Serie 48,0

Totalt 182,0

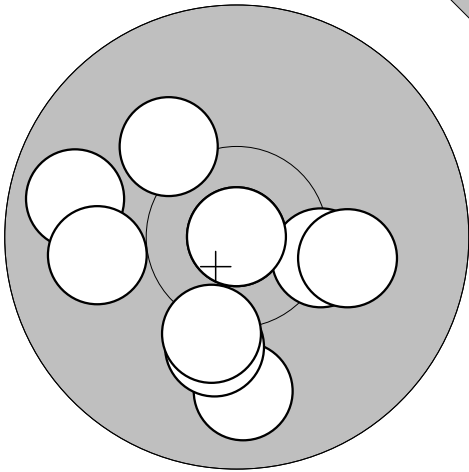
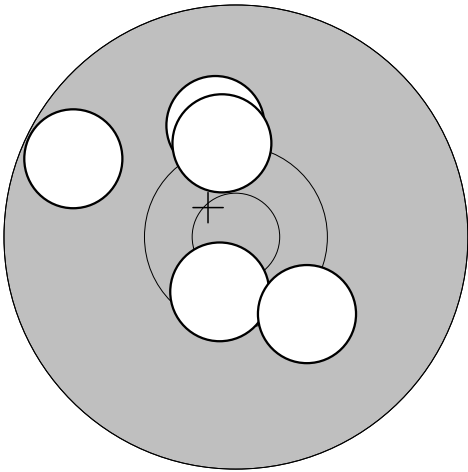
<b>Provsnitt</b> 	1: 10,1 ↗ 2: 9,8 ← 3: 0,0 4: 9,8 ↓ 5: 10,1 ↓ 6: 10,2 ↓ 7: 10,0 ← 8: 10,3* → 9: 10,1 → 10: 0,0 <hr/> Serie 78,0 Totalt 0,0	<b>Tävlingssnitt</b> 	1: 10,1 ↑ 2: 10,5* ↓ 3: 9,7 ↖ 4: 10,3 ↑ 5: 10,2 ↘ <hr/> Serie 49,0 Totalt 49,0
--	--	--	--

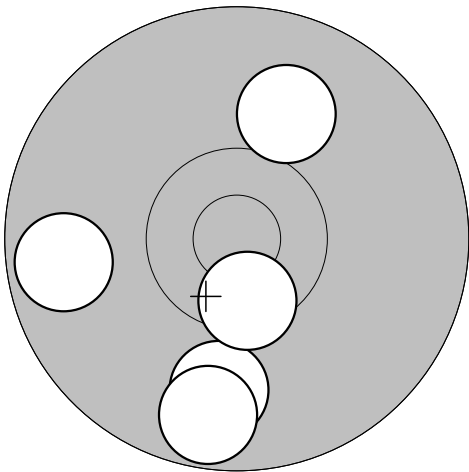
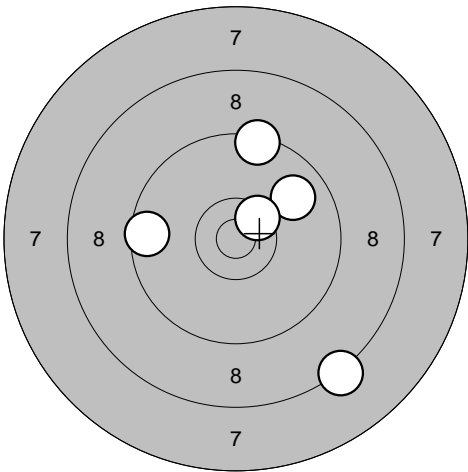
<b>Tävlingssnitt</b> 	6: 9,9 ↓ 7: 9,7 ↓ 8: 10,0 ↗ 9: 10,5* ↓ 10: 9,7 ← <hr/> Serie 47,0 Totalt 96,0	<b>Tävlingssnitt</b> 	11: 8,3 ↘ 12: 9,4 ↑ 13: 9,8 ↗ 14: 9,6 ← 15: 10,5* ↗ <hr/> Serie 45,0 Totalt 141,0
---	---	---	---

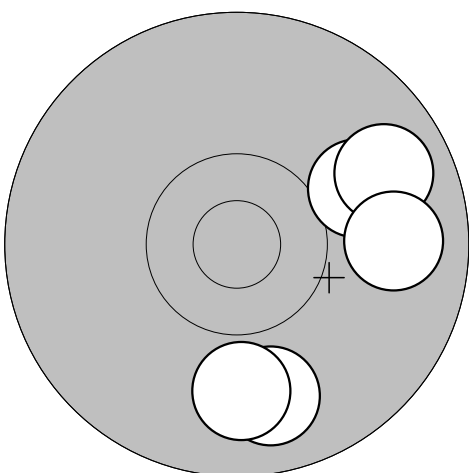
<b>Tävlingssnitt</b> 	16: 9,8 ↓ 17: 10,0 ↗ 18: 9,8 ↗ 19: 9,8 → 20: 9,9 ↓ <hr/> Serie 46,0 Totalt 187,0	
--	--	--

2009-07-16

Tavelträffen 2009

Ramselefors SKF

Provsjött

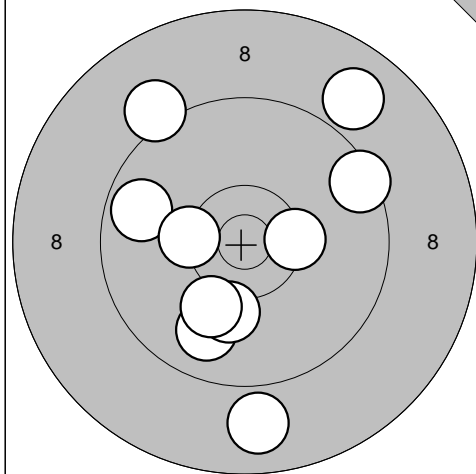

- 1: 9,8 ↘
- 2: 8,9 ↘
- 3: 10,1 ↘
- 4: 8,9 ↗
- 5: 9,1 ↗
- 6: 9,7 ↖
- 7: 9,5 ↗
- 8: 10,1 ↘
- 9: 10,4\* →
- 10: 10,3\* ←

Serie 92,0

Totalt 0,0

Provsjött

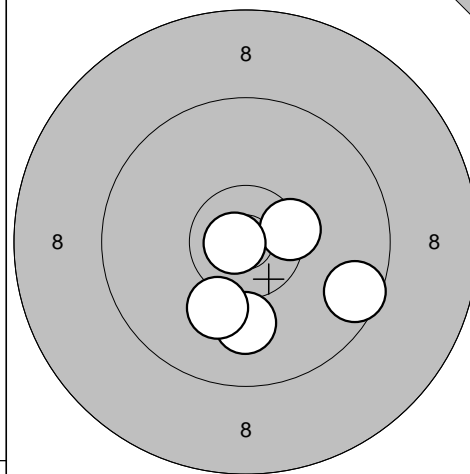

- 11: 10,0 ↘
- 12: 10,1 ↘
- 13: 9,6 →
- 14: 10,4\* →
- 15: 10,8\* ←

Serie 49,0

Totalt 0,0

Tävlingssjött

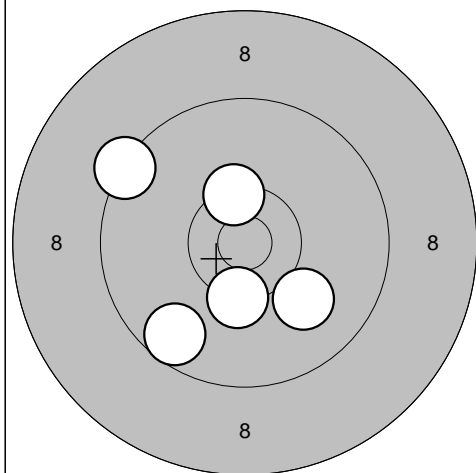

- 1: 10,4\* ↗
- 2: 9,6 ↘
- 3: 10,3\* ↘
- 4: 10,0 ↘
- 5: 9,3 ↗

Serie 48,0

Totalt 48,0

Tävlingssjött

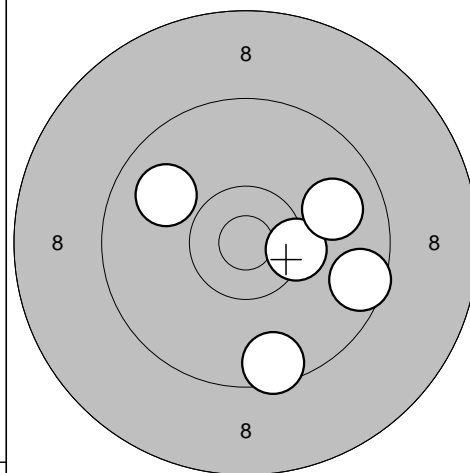

- 6: 9,9 ↖
- 7: 10,4\* →
- 8: 9,9 →
- 9: 9,5 ↘
- 10: 9,6 →

Serie 46,0

Totalt 94,0

Tävlingssjött

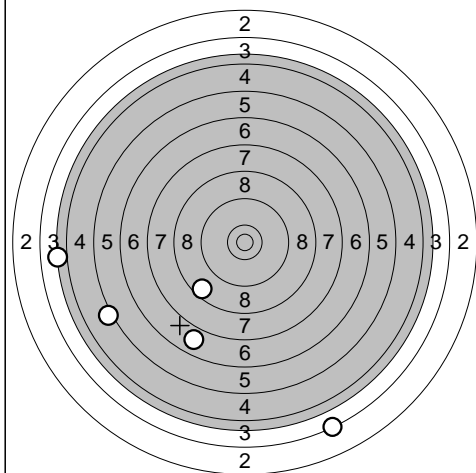

- 11: 8,6 ↘
- 12: 5,2 ↖
- 13: 4,0 ↖
- 14: 6,8 ↘
- 15: 3,3 ↘

Serie 26,0

Totalt 120,0

Tävlingssjött

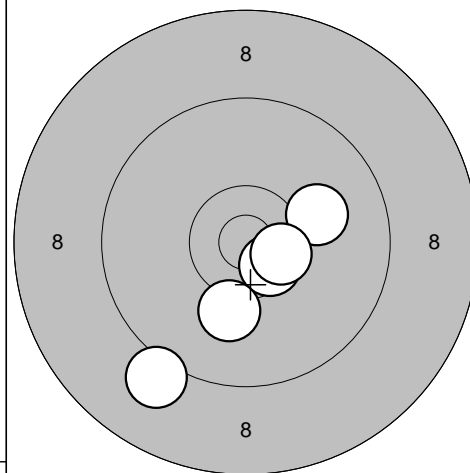

- 16: 10,6\* ↘
- 17: 10,1 →
- 18: 10,5\* →
- 19: 10,1 ↘
- 20: 9,1 ↘

Serie 49,0

Totalt 169,0

S 3

2009-07-16

Tavelträffen 2009

Ramselefors SKF

Provsjott

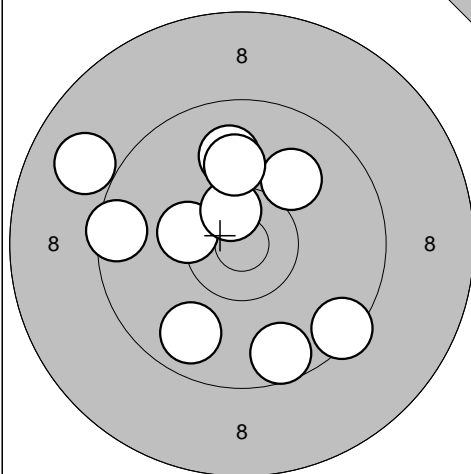

1: 9,4 ↘  
 2: 9,6 ↘  
 3: 9,8 ↘  
 4: 10,3\* ←  
 5: 10,6\* ↑  
 6: 8,9 ↗  
 7: 9,9 ↑  
 8: 9,5 ←  
 9: 10,0 ↗  
 10: 10,0 ↑

Serie 93,0

Totalt 0,0

Provsjott

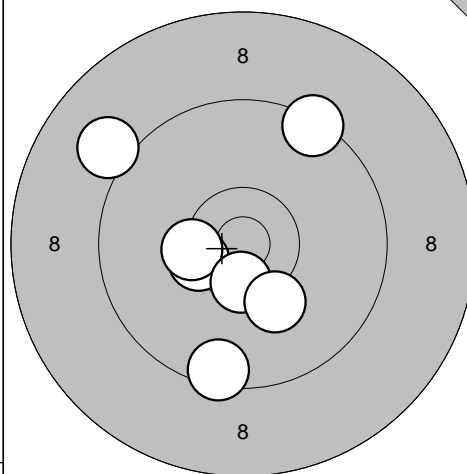

11: 9,4 ↗  
 12: 9,1 ↖  
 13: 10,4\* ←  
 14: 9,5 ↘  
 15: 10,4\* ←  
 16: 10,5\* ↘  
 17: 10,2 ↘

Serie 67,0

Totalt 0,0

Tävlingssjott

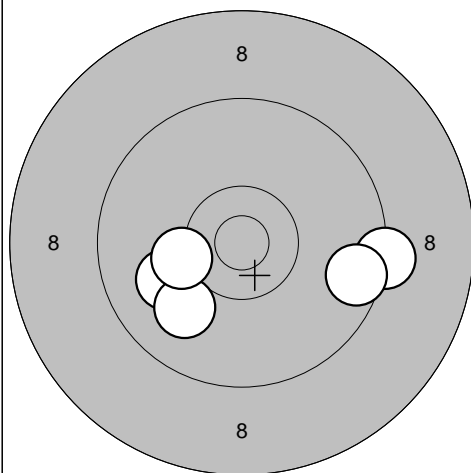

1: 10,0 ←  
 2: 9,3 →  
 3: 9,6 →  
 4: 10,0 ↘  
 5: 10,2 ←

Serie 48,0

Totalt 48,0

Tävlingssjott

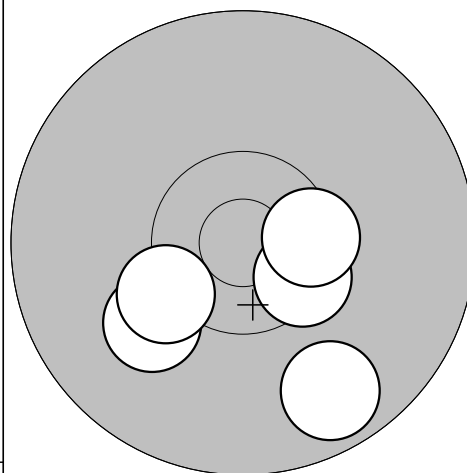

6: 9,7 ↘  
 7: 10,5\* ↘  
 8: 10,5\* →  
 9: 10,1 ↘  
 10: 10,3\* ↘

Serie 49,0

Totalt 97,0

Tävlingssjott

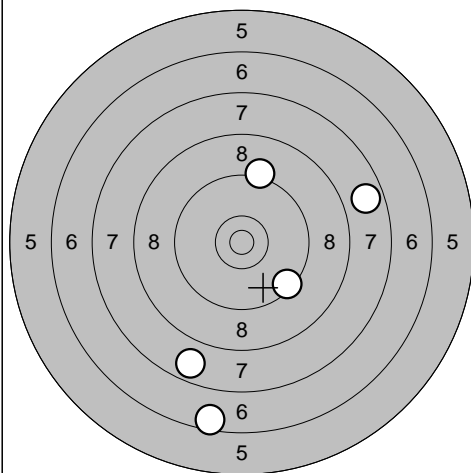

11: 9,2 ↑  
 12: 7,7 →  
 13: 6,6 ↘  
 14: 7,7 ↘  
 15: 9,4 ↘

Serie 38,0

Totalt 135,0

Tävlingssjott

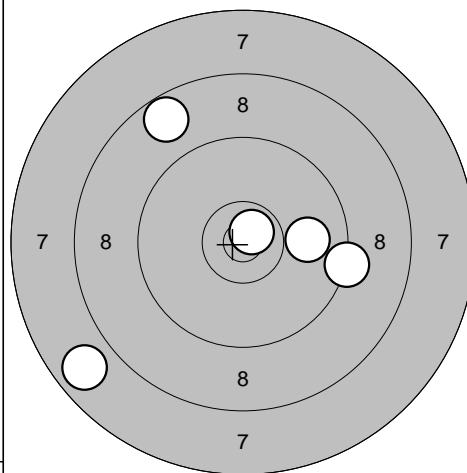

16: 8,7 ↗  
 17: 9,3 →  
 18: 7,8 ↘  
 19: 10,7\* ↗  
 20: 9,9 →

Serie 43,0

Totalt 178,0

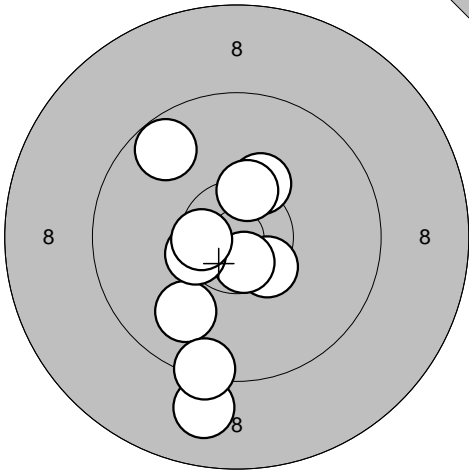
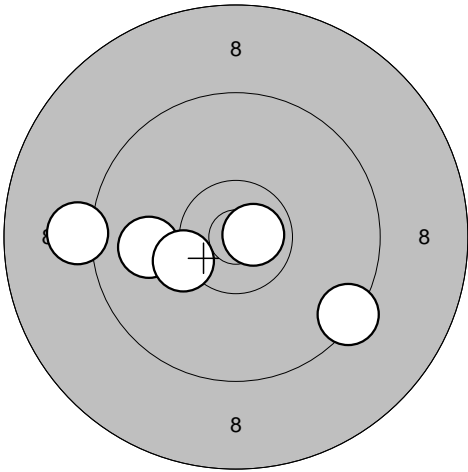

<b>Provsjött</b> 	<table style="width:100%; border-collapse: collapse;"> <tr><td>1: 9,0</td><td style="text-align: right;">↘</td></tr> <tr><td>2: 9,9</td><td style="text-align: right;">↘</td></tr> <tr><td>3: 9,4</td><td style="text-align: right;">↘</td></tr> <tr><td>4: 10,3</td><td style="text-align: right;">↗</td></tr> <tr><td>5: 10,5*</td><td style="text-align: right;">↘</td></tr> <tr><td>6: 10,4*</td><td style="text-align: right;">↗</td></tr> <tr><td>7: 9,7</td><td style="text-align: right;">↗</td></tr> <tr><td>8: 10,6*</td><td style="text-align: right;">↘</td></tr> <tr><td>9: 10,4*</td><td style="text-align: right;">↖</td></tr> <tr><td>10: 10,6*</td><td style="text-align: right;">↖</td></tr> <tr><td colspan="2"><hr/></td></tr> <tr><td>Serie</td><td style="text-align: right;">96,0</td></tr> <tr><td>Totalt</td><td style="text-align: right;">0,0</td></tr> </table>	1: 9,0	↘	2: 9,9	↘	3: 9,4	↘	4: 10,3	↗	5: 10,5*	↘	6: 10,4*	↗	7: 9,7	↗	8: 10,6*	↘	9: 10,4*	↖	10: 10,6*	↖	<hr/>		Serie	96,0	Totalt	0,0	<b>Tävlingssjött</b>  <table style="width:100%; border-collapse: collapse;"> <tr><td>1: 10,0</td><td style="text-align: right;">↖</td></tr> <tr><td>2: 9,2</td><td style="text-align: right;">↖</td></tr> <tr><td>3: 10,3*</td><td style="text-align: right;">↖</td></tr> <tr><td>4: 10,7*</td><td style="text-align: right;">↗</td></tr> <tr><td>5: 9,4</td><td style="text-align: right;">↘</td></tr> <tr><td colspan="2"><hr/></td></tr> <tr><td>Serie</td><td style="text-align: right;">48,0</td></tr> <tr><td>Totalt</td><td style="text-align: right;">48,0</td></tr> </table>	1: 10,0	↖	2: 9,2	↖	3: 10,3*	↖	4: 10,7*	↗	5: 9,4	↘	<hr/>		Serie	48,0	Totalt	48,0
1: 9,0	↘																																											
2: 9,9	↘																																											
3: 9,4	↘																																											
4: 10,3	↗																																											
5: 10,5*	↘																																											
6: 10,4*	↗																																											
7: 9,7	↗																																											
8: 10,6*	↘																																											
9: 10,4*	↖																																											
10: 10,6*	↖																																											
<hr/>																																												
Serie	96,0																																											
Totalt	0,0																																											
1: 10,0	↖																																											
2: 9,2	↖																																											
3: 10,3*	↖																																											
4: 10,7*	↗																																											
5: 9,4	↘																																											
<hr/>																																												
Serie	48,0																																											
Totalt	48,0																																											

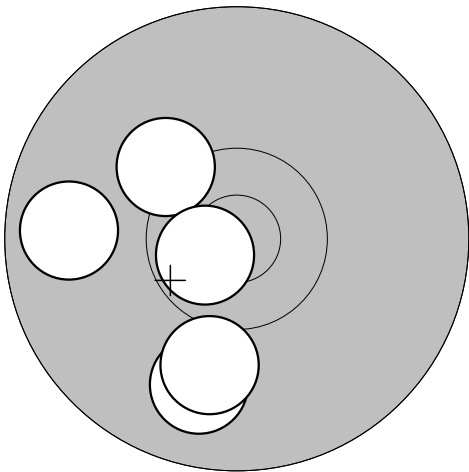
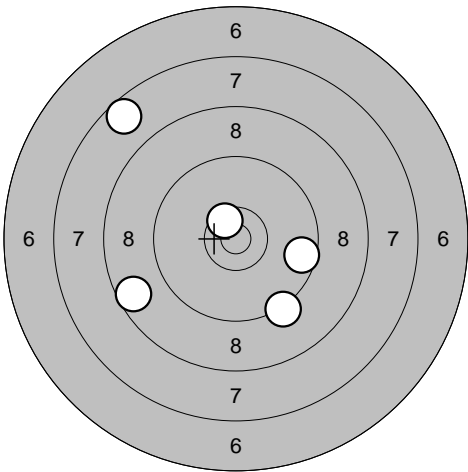
<b>Tävlingssjött</b> 	<table style="width:100%; border-collapse: collapse;"> <tr><td>6: 9,9</td><td style="text-align: right;">↘</td></tr> <tr><td>7: 10,2</td><td style="text-align: right;">↗</td></tr> <tr><td>8: 9,8</td><td style="text-align: right;">↖</td></tr> <tr><td>9: 10,7*</td><td style="text-align: right;">↖</td></tr> <tr><td>10: 10,0</td><td style="text-align: right;">↘</td></tr> <tr><td colspan="2"><hr/></td></tr> <tr><td>Serie</td><td style="text-align: right;">48,0</td></tr> <tr><td>Totalt</td><td style="text-align: right;">96,0</td></tr> </table>	6: 9,9	↘	7: 10,2	↗	8: 9,8	↖	9: 10,7*	↖	10: 10,0	↘	<hr/>		Serie	48,0	Totalt	96,0	<b>Tävlingssjött</b>  <table style="width:100%; border-collapse: collapse;"> <tr><td>11: 9,2</td><td style="text-align: right;">↘</td></tr> <tr><td>12: 9,6</td><td style="text-align: right;">↗</td></tr> <tr><td>13: 7,6</td><td style="text-align: right;">↗</td></tr> <tr><td>14: 8,6</td><td style="text-align: right;">↖</td></tr> <tr><td>15: 10,5*</td><td style="text-align: right;">↗</td></tr> <tr><td colspan="2"><hr/></td></tr> <tr><td>Serie</td><td style="text-align: right;">43,0</td></tr> <tr><td>Totalt</td><td style="text-align: right;">139,0</td></tr> </table>	11: 9,2	↘	12: 9,6	↗	13: 7,6	↗	14: 8,6	↖	15: 10,5*	↗	<hr/>		Serie	43,0	Totalt	139,0
6: 9,9	↘																																	
7: 10,2	↗																																	
8: 9,8	↖																																	
9: 10,7*	↖																																	
10: 10,0	↘																																	
<hr/>																																		
Serie	48,0																																	
Totalt	96,0																																	
11: 9,2	↘																																	
12: 9,6	↗																																	
13: 7,6	↗																																	
14: 8,6	↖																																	
15: 10,5*	↗																																	
<hr/>																																		
Serie	43,0																																	
Totalt	139,0																																	

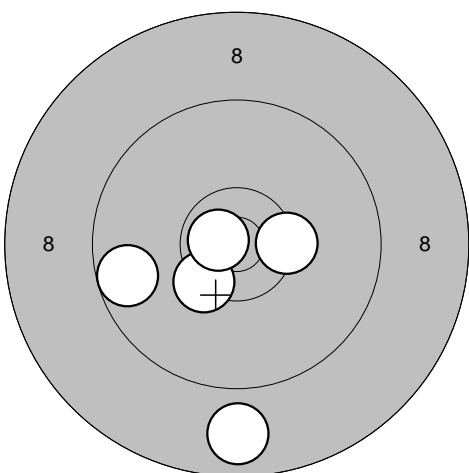
<b>Tävlingssjött</b> 	<table style="width:100%; border-collapse: collapse;"> <tr><td>16: 10,4*</td><td style="text-align: right;">↗</td></tr> <tr><td>17: 10,4*</td><td style="text-align: right;">↘</td></tr> <tr><td>18: 9,7</td><td style="text-align: right;">↖</td></tr> <tr><td>19: 8,8</td><td style="text-align: right;">↘</td></tr> <tr><td>20: 10,7*</td><td style="text-align: right;">↖</td></tr> <tr><td colspan="2"><hr/></td></tr> <tr><td>Serie</td><td style="text-align: right;">47,0</td></tr> <tr><td>Totalt</td><td style="text-align: right;">186,0</td></tr> </table>	16: 10,4*	↗	17: 10,4*	↘	18: 9,7	↖	19: 8,8	↘	20: 10,7*	↖	<hr/>		Serie	47,0	Totalt	186,0	
16: 10,4*	↗																	
17: 10,4*	↘																	
18: 9,7	↖																	
19: 8,8	↘																	
20: 10,7*	↖																	
<hr/>																		
Serie	47,0																	
Totalt	186,0																	

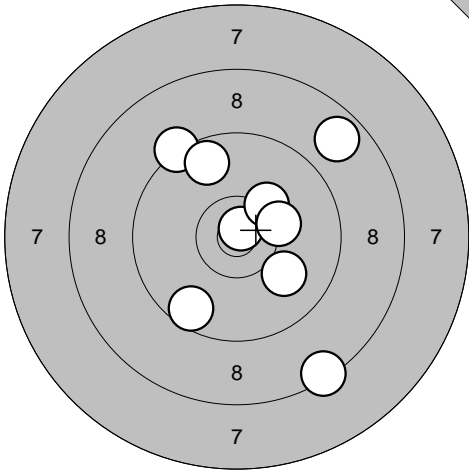
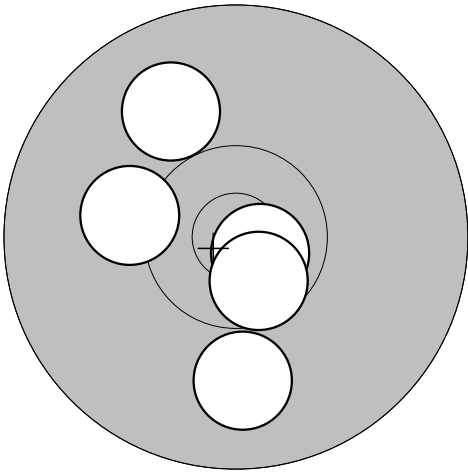
<p>Provs-kott</p> 	<p>Tävlingsskott</p> 	
1: 10,8* ↗ 2: 10,0 ↘ 3: 8,7 ↗ 4: 10,3 ↗ 5: 9,3 ↗ 6: 9,7 ↗ 7: 8,4 ↘ 8: 9,6 ↘ 9: 10,3 →	1: 10,2 ← 2: 9,9 ↗ 3: 9,9 ↘ 4: 10,7* ↘ 5: 10,6* ↘	
Serie 83,0	Serie 48,0	
Totalt 0,0	Totalt 48,0	

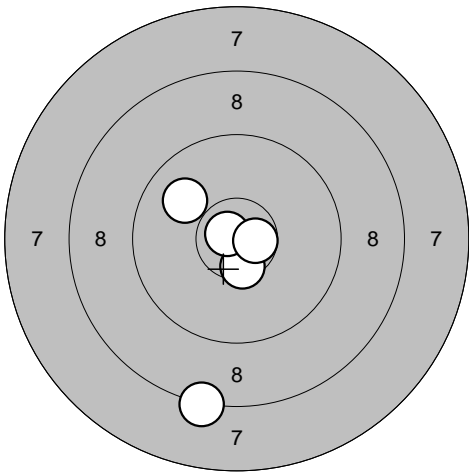
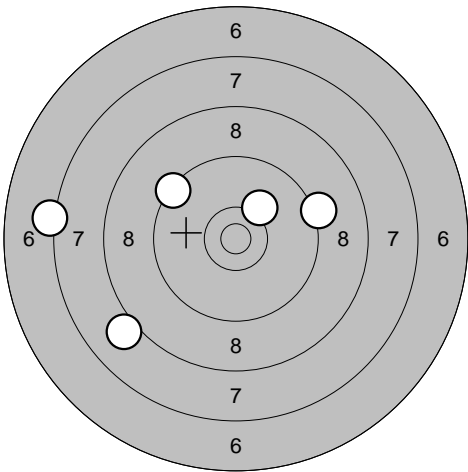
<p>Tävlingsskott</p> 	<p>Tävlingsskott</p> 	
6: 8,3 ↘ 7: 10,5* ↘ 8: 9,9 ↗ 9: 10,8* ↗ 10: 10,6* →	11: 7,2 ← 12: 9,4 ↘ 13: 10,2 ↗ 14: 9,2 → 15: 8,0 ↘	
Serie 47,0	Serie 43,0	
Totalt 95,0	Totalt 138,0	

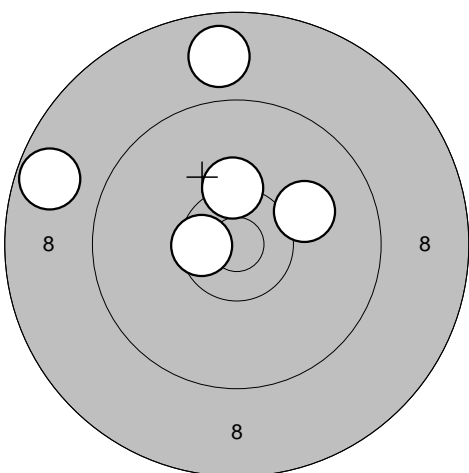
<p>Tävlingsskott</p> 		
16: 8,8 ↑ 17: 10,3* ↑ 18: 10,6* ← 19: 10,1 ↗ 20: 8,7 ←		
Serie 46,0		
Totalt 184,0		

Ale

2009-07-16

Tavelträffen 2009

Ramselefors SKF

Provs-kott

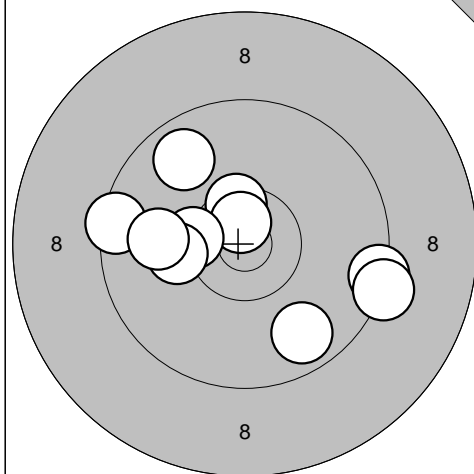

1: 9,5 ←  
 2: 10,5\* ↑  
 3: 9,8 ↗  
 4: 10,7\* ↑  
 5: 9,4 →  
 6: 10,4\* ←  
 7: 9,3 →  
 8: 9,7 ↓  
 9: 10,2 ←  
 10: 10,0 ←

Serie 95,0

Totalt 0,0

Tävlingsskott

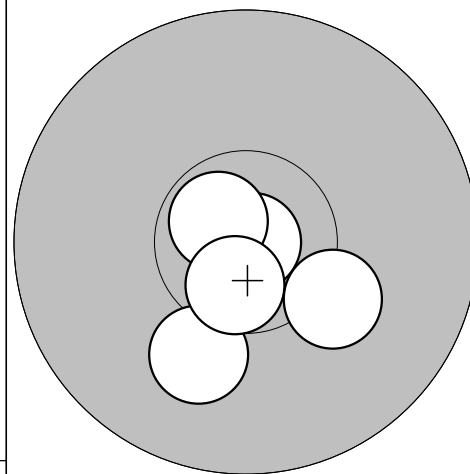

1: 10,9\* →  
 2: 10,2 ↘  
 3: 10,1 ↓  
 4: 10,7\* ↖  
 5: 10,6\* ↓

Serie 50,0

Totalt 50,0

Tävlingsskott

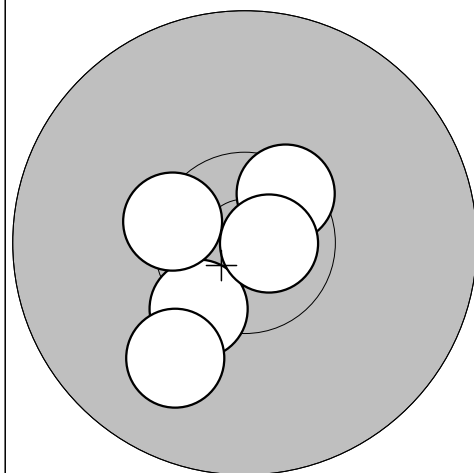

6: 10,4\* ↘  
 7: 10,4\* ←  
 8: 10,5\* ↗  
 9: 10,8\* →  
 10: 10,0 ↓

Serie 50,0

Totalt 100,0

Tävlingsskott

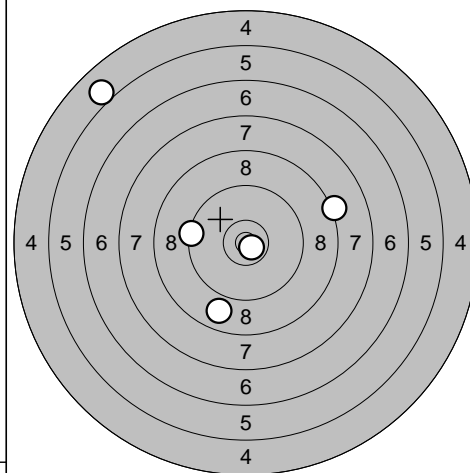

11: 8,9 ↓  
 12: 5,0 ↖  
 13: 10,7\* ↘  
 14: 9,4 ←  
 15: 8,2 →

Serie 40,0

Totalt 140,0

Tävlingsskott

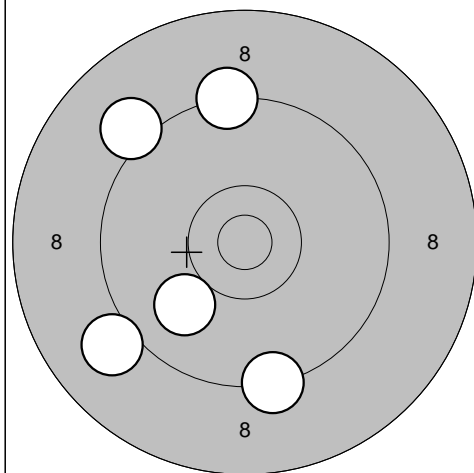

16: 9,3 ↑  
 17: 9,1 ↖  
 18: 9,0 ↘  
 19: 10,0 ↘  
 20: 9,3 ↓

Serie 46,0

Totalt 186,0

2009-07-16

Tavelträffen 2009

Ramselefors SKF

Provskott

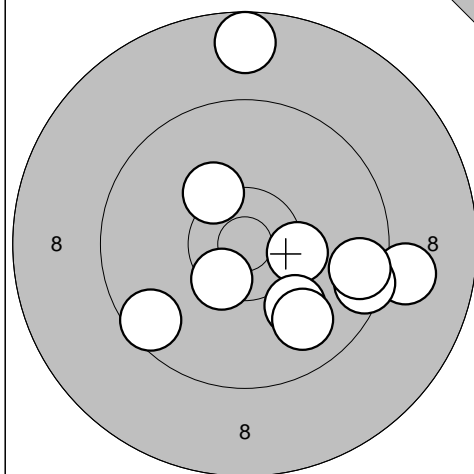

1: 9,1 →  
 2: 10,3\* →  
 3: 9,5 →  
 4: 9,6 →  
 5: 9,6 ↙  
 6: 10,0 ↘  
 7: 10,5\* ↘  
 8: 8,7 ↑  
 9: 9,9 ↘  
 10: 10,3 ↗

Serie 93,0

Totalt 0,0

Provskott

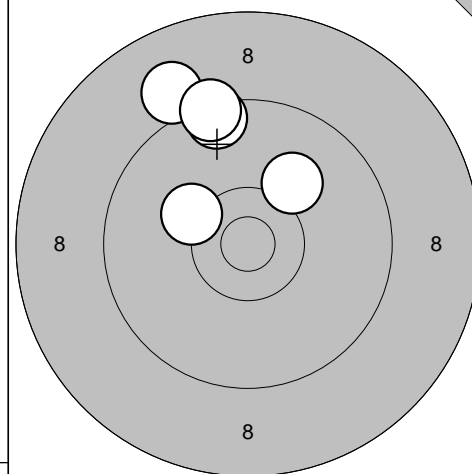

11: 10,1 ↗  
 12: 10,2 ↖  
 13: 9,5 ↑  
 14: 9,0 ↗  
 15: 9,4 ↑

Serie 47,0

Totalt 0,0

Tävlingsskott

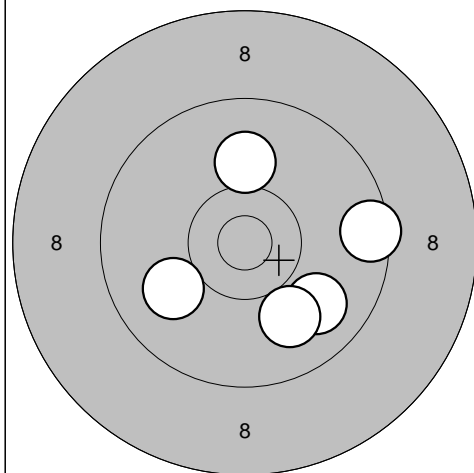

1: 10,0 ↑  
 2: 9,5 →  
 3: 9,9 ↘  
 4: 10,0 ↘  
 5: 10,0 ↙

Serie 48,0

Totalt 48,0

Tävlingsskott

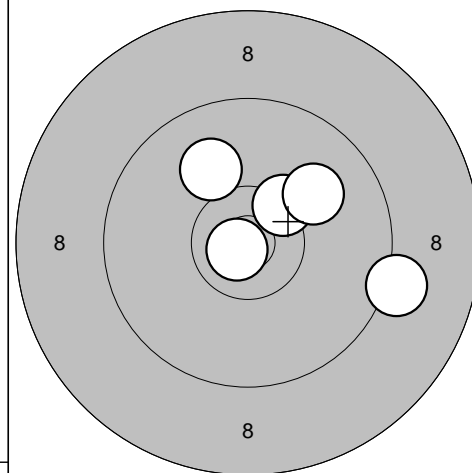

6: 10,4\* ↗  
 7: 10,0 ↗  
 8: 10,8\* ↖  
 9: 9,2 →  
 10: 10,0 ↗

Serie 49,0

Totalt 97,0

Tävlingsskott

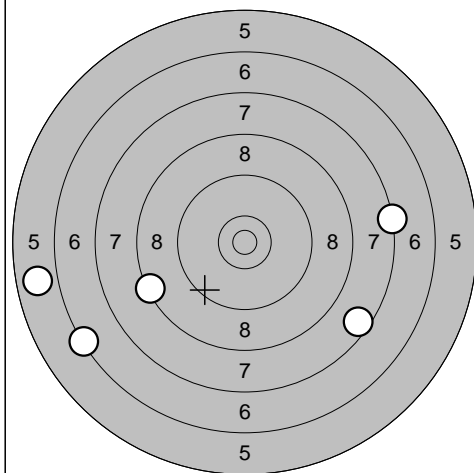

11: 7,3 →  
 12: 6,3 ↖  
 13: 8,4 ↖  
 14: 5,8 ←  
 15: 7,6 ↘

Serie 33,0

Totalt 130,0

Tävlingsskott

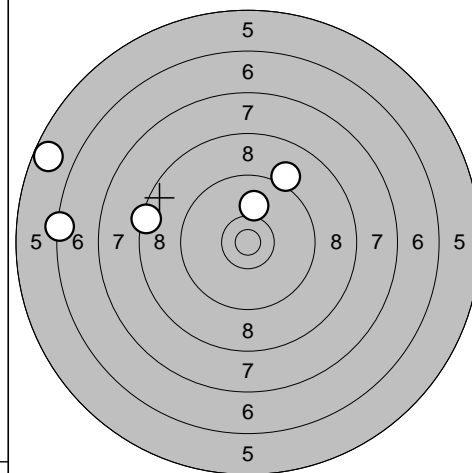

16: 8,4 ←  
 17: 9,1 ↗  
 18: 10,1 ↑  
 19: 6,4 ←  
 20: 5,7 ↖

Serie 38,0

Totalt 168,0

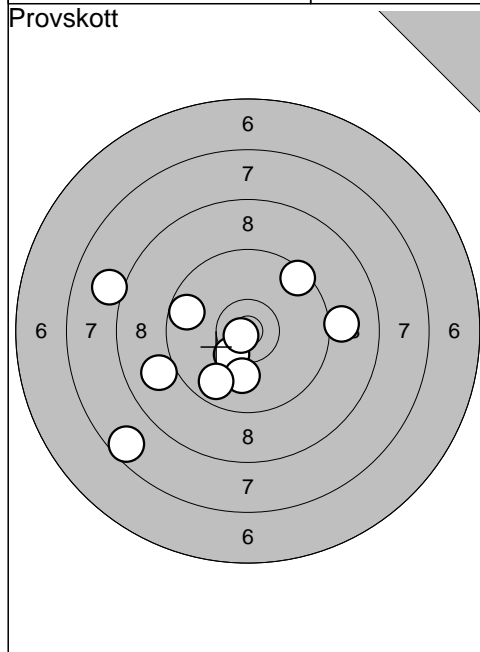

1: 10,4*	↙
2: 9,5	↗
3: 9,1	→
4: 7,6	↙
5: 9,0	←
6: 8,1	←
7: 10,0	↓
8: 10,8*	↙
9: 9,7	←
10: 9,8	↙
Serie	90,0
Totalt	0,0

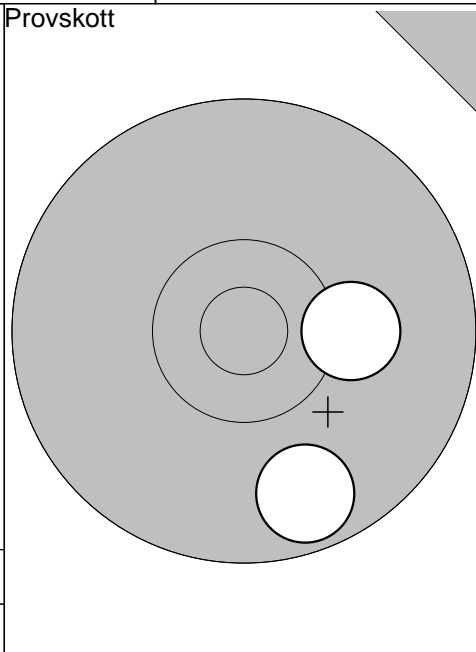

11: 9,7	↘
12: 10,2	→
Serie	19,0
Totalt	0,0

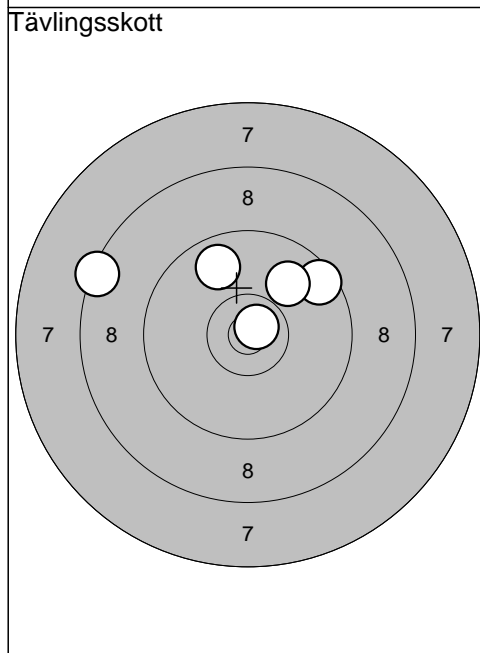

1: 9,6	↗
2: 8,4	←
3: 9,8	↗
4: 10,8*	↗
5: 9,9	↗
Serie	45,0
Totalt	45,0

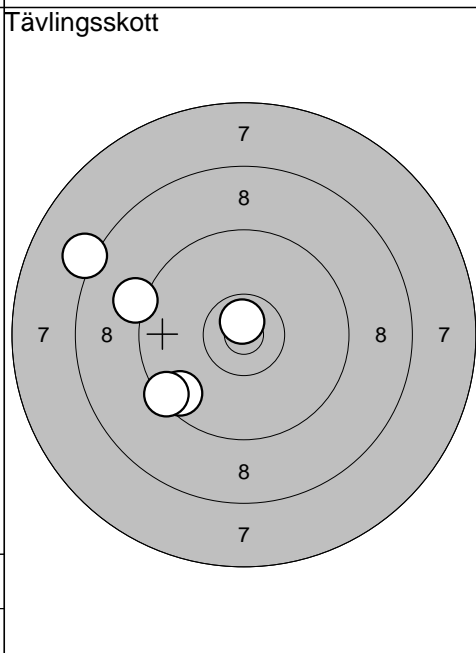

6: 9,6	↙
7: 10,8*	↑
8: 9,4	↙
9: 9,2	←
10: 8,2	↙
Serie	45,0
Totalt	90,0

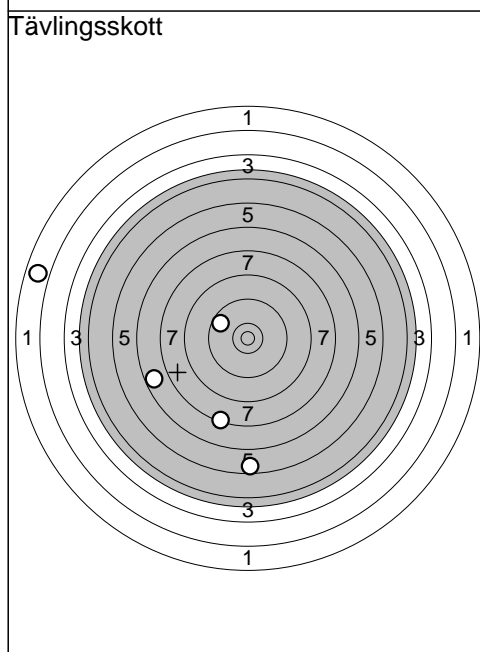

11: 1,8	←
12: 7,4	↓
13: 9,7	↙
14: 6,7	←
15: 5,6	↓
Serie	28,0
Totalt	118,0

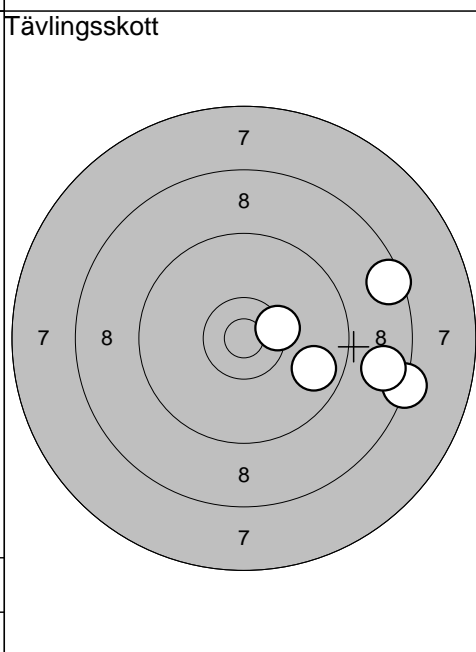

16: 8,3	→
17: 8,7	→
18: 10,4*	→
19: 9,8	↘
20: 8,5	→
Serie	43,0
Totalt	161,0

Drängsmark

2009-07-16

Tavelträffen 2009

Ramselefors SKF

Provskott

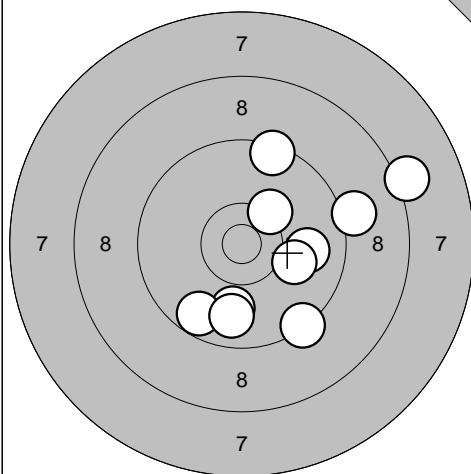

1: 8,2 →  
 2: 9,3 ↓  
 3: 9,9 ↓  
 4: 9,1 →  
 5: 9,7 ↓  
 6: 9,9 →  
 7: 10,1 →  
 8: 9,8 ↓  
 9: 10,3 ↗  
 10: 9,4 ↗

Serie 91,0

Totalt 0,0

Provskott

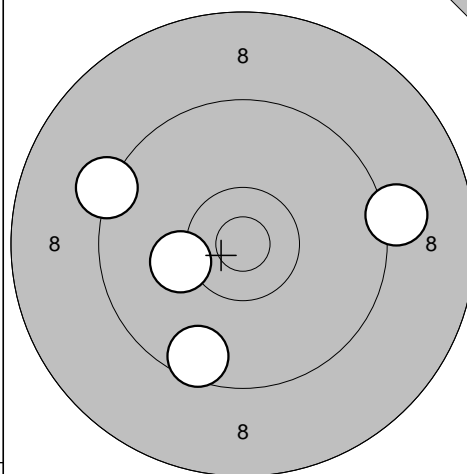

11: 9,6 ↓  
 12: 10,2 ←  
 13: 9,2 →  
 14: 9,3 ←

Serie 37,0

Totalt 0,0

Tävlingsskott

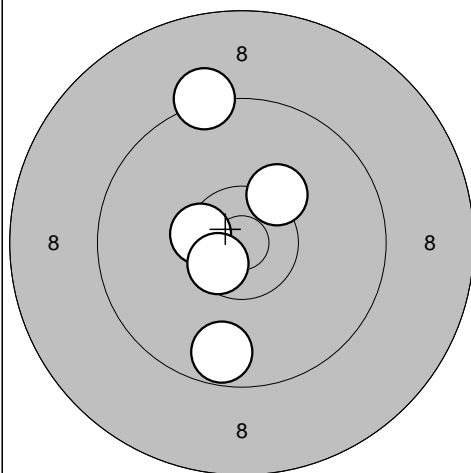

1: 10,3 ↗  
 2: 9,7 ↓  
 3: 10,5\* ←  
 4: 9,3 ↑  
 5: 10,6\* ↘

Serie 48,0

Totalt 48,0

Tävlingsskott

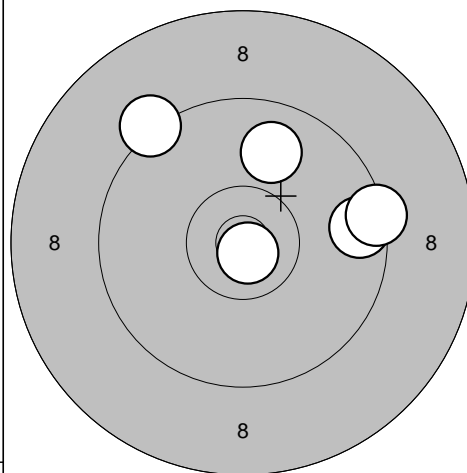

6: 9,6 →  
 7: 9,9 ↑  
 8: 9,3 ↗  
 9: 10,8\* ↓  
 10: 9,4 →

Serie 46,0

Totalt 94,0

Tävlingsskott

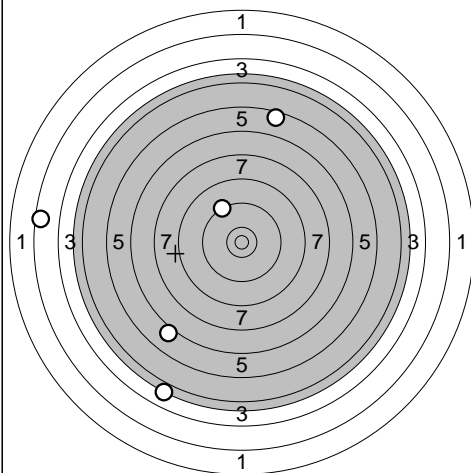

11: 2,5 ←  
 12: 6,1 ↓  
 13: 5,6 ↑  
 14: 9,3 ↗  
 15: 3,9 ↓

Serie 25,0

Totalt 119,0

Tävlingsskott

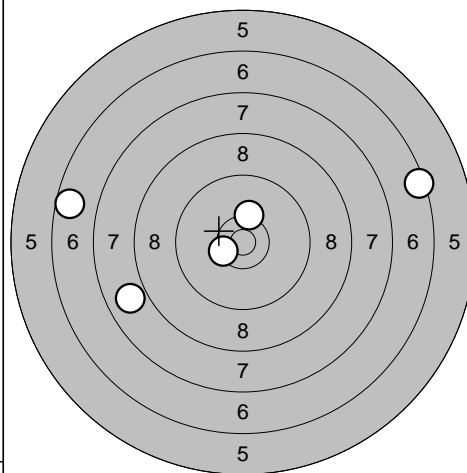

16: 6,4 →  
 17: 7,9 ←  
 18: 10,4\* ←  
 19: 6,6 ←  
 20: 10,3 ↑

Serie 39,0

Totalt 158,0

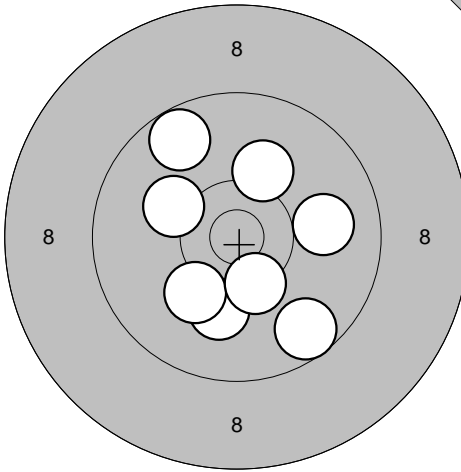
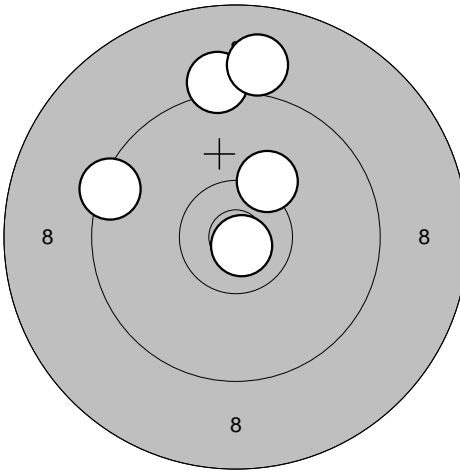
<b>Provs-kott</b> 	1: 10,1 ↓ 2: 10,2 ↘ 3: 10,2 ↖ 4: 9,7 ↗ 5: 10,0 → 6: 10,1 ↗ 7: 9,6 ↘ 8: 10,4* ↘	<b>Tävlingsskott</b> 	1: 9,2 ↑ 2: 10,2 ↗ 3: 10,8* ↘ 4: 9,4 ↖ 5: 9,0 ↑
Serie 78,0		Serie 47,0	
Totalt 0,0		Totalt 47,0	

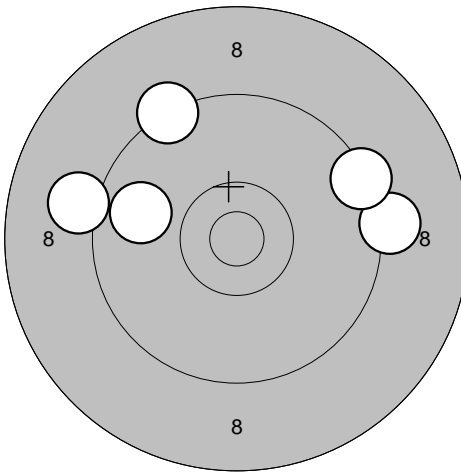
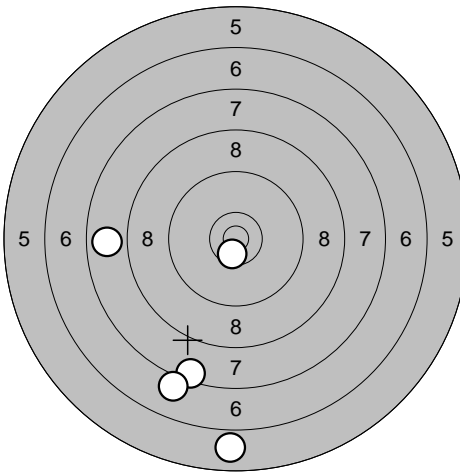
<b>Tävlingsskott</b> 	6: 9,2 → 7: 9,3 ↗ 8: 9,8 ↖ 9: 9,1 ↖ 10: 9,4 →	<b>Tävlingsskott</b> 	11: 7,5 ↓ 12: 7,1 ↘ 13: 7,8 ↖ 14: 10,6* ↘ 15: 5,9 ↓
Serie 45,0		Serie 36,0	
Totalt 92,0		Totalt 128,0	

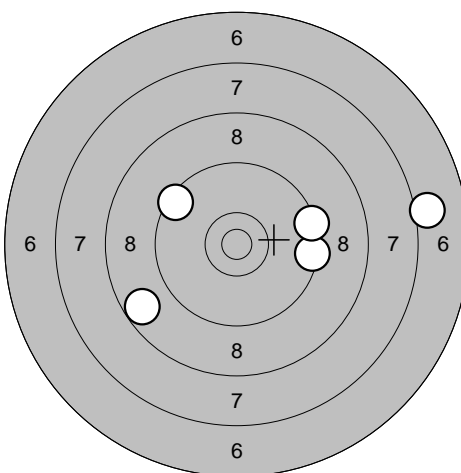
<b>Tävlingsskott</b> 	16: 9,5 ↖ 17: 9,4 → 18: 7,1 → 19: 9,4 → 20: 8,7 ↘		
Serie 42,0			
Totalt 170,0			

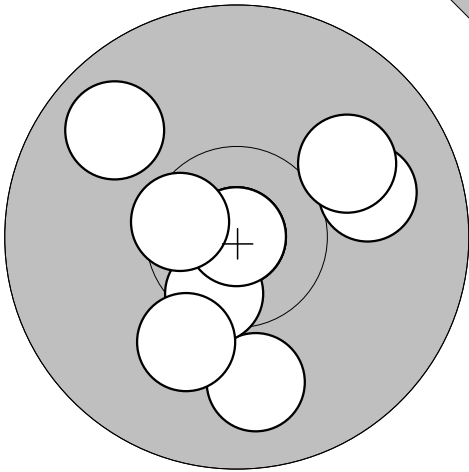
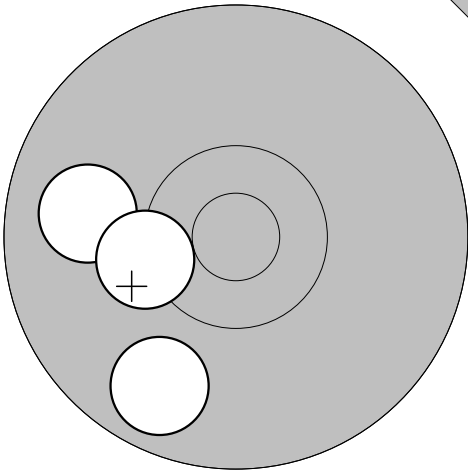
<p>Provskott</p> 	<p>1: 0,0 2: 9,8 ↗ 3: 9,9 ↓ 4: 0,0 5: 10,5* ↓ 6: 10,1 ↓ 7: 10,0 → 8: 0,0 9: 10,0 ↗ 10: 10,5* ←</p> <p>Serie 68,0 Totalt 0,0</p>	<p>Provskott</p> 	<p>11: 9,9 ← 12: 10,3* ← 13: 9,8 ↓</p> <p>Serie 28,0 Totalt 0,0</p>
---	---	---	---

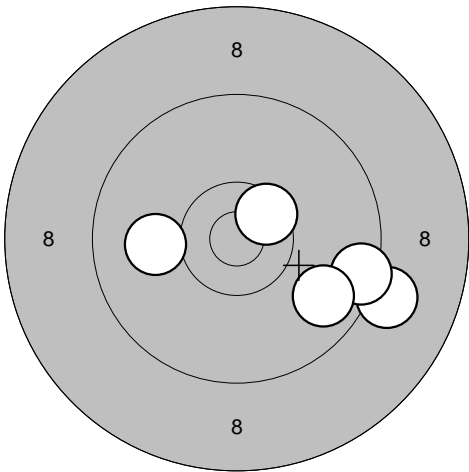
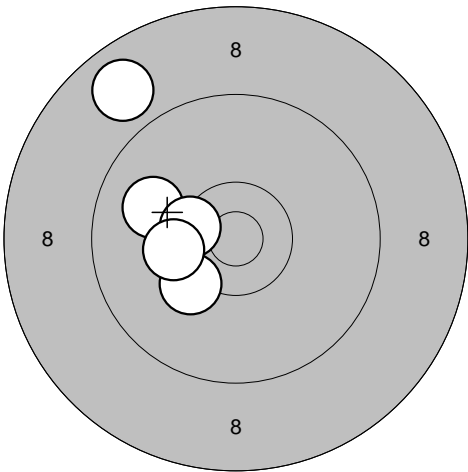
<p>Tävlingsskott</p> 	<p>1: 10,5* ↗ 2: 9,1 → 3: 10,0 ← 4: 9,5 → 5: 9,8 ↓</p> <p>Serie 47,0 Totalt 47,0</p>	<p>Tävlingsskott</p> 	<p>6: 10,2 ↙ 7: 9,9 ← 8: 10,4* ← 9: 10,2 ← 10: 8,8 ↗</p> <p>Serie 47,0 Totalt 94,0</p>
--	--	--	--

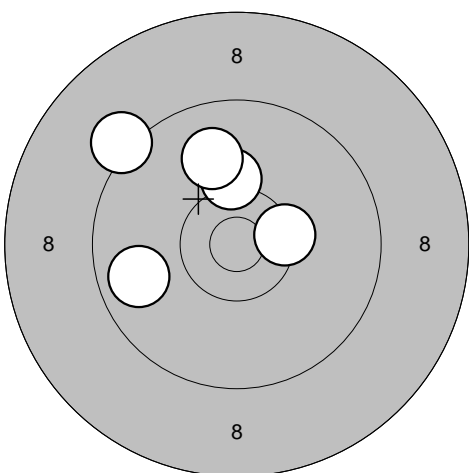
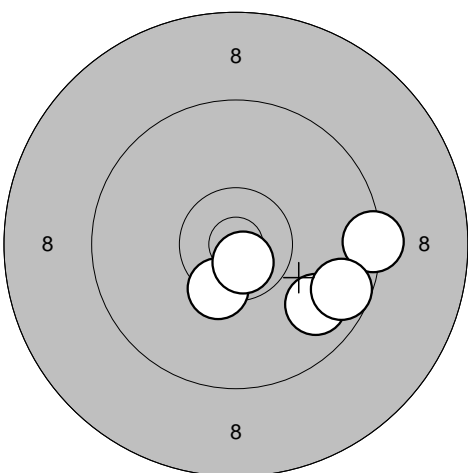
<p>Tävlingsskott</p> 	<p>11: 9,2 ↙ 12: 9,8 ← 13: 10,4* → 14: 10,2 ↑ 15: 9,9 ↗</p> <p>Serie 47,0 Totalt 141,0</p>	<p>Tävlingsskott</p> 	<p>16: 10,4* ↓ 17: 10,7* ↓ 18: 9,8 ↙ 19: 9,4 → 20: 9,6 ↘</p> <p>Serie 47,0 Totalt 188,0</p>
---	--	---	---



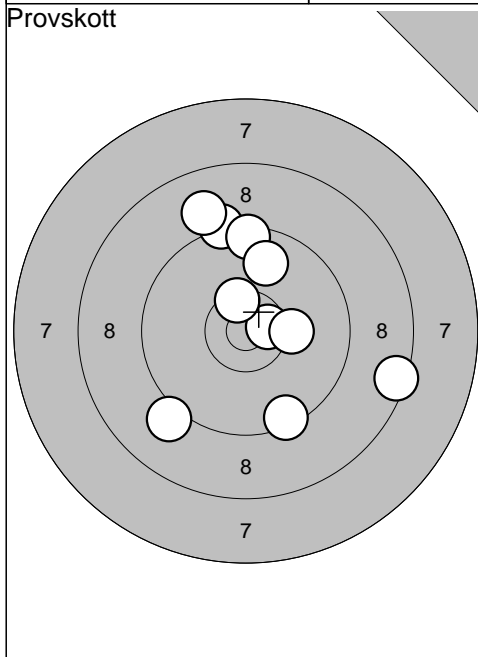

1: 9,1	↙
2: 10,6*	→
3: 9,3	↑
4: 9,0	↑
5: 8,5	→
6: 10,2	→
7: 9,4	↓
8: 9,5	↑
9: 10,5*	↑
10: 9,8	↑
<hr/>	
Serie	92,0
Totalt	0,0

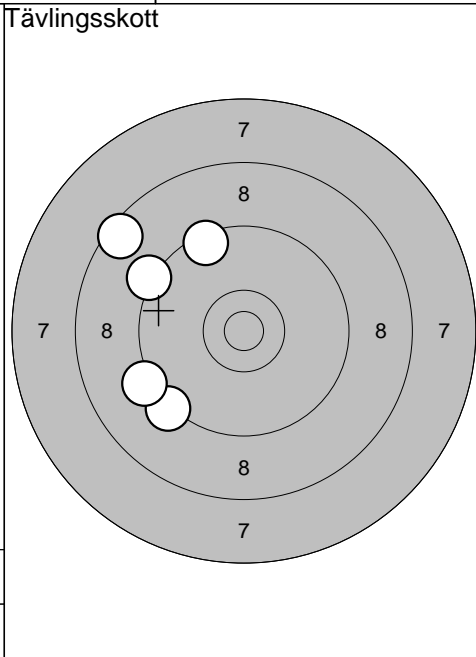

1: 9,2	↙
2: 9,2	↙
3: 8,5	↖
4: 9,3	↖
5: 9,5	↑
<hr/>	
Serie	44,0
Totalt	44,0

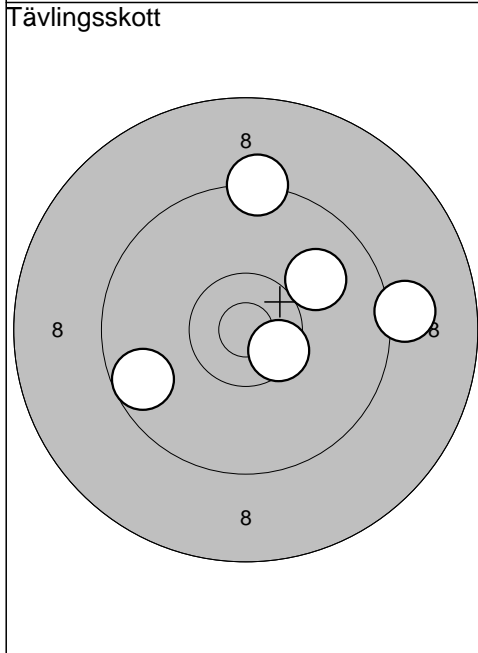

6: 9,7	↙
7: 9,3	↑
8: 10,5*	↘
9: 9,1	→
10: 10,0	↗
<hr/>	
Serie	47,0
Totalt	91,0

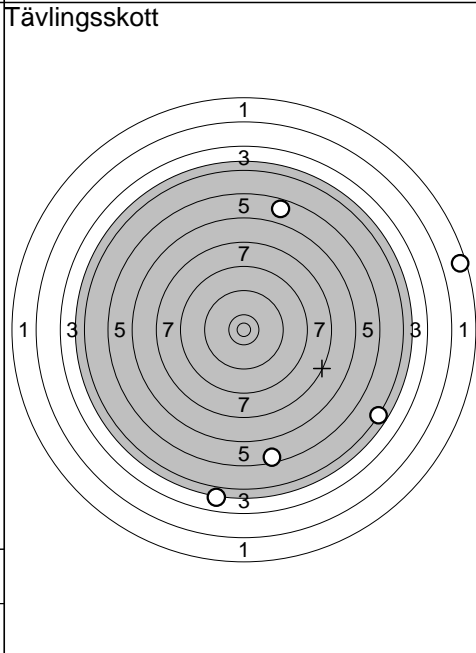

11: 3,9	↓
12: 5,5	↓
13: 5,7	↑
14: 1,5	→
15: 4,3	↘
<hr/>	
Serie	18,0
Totalt	109,0

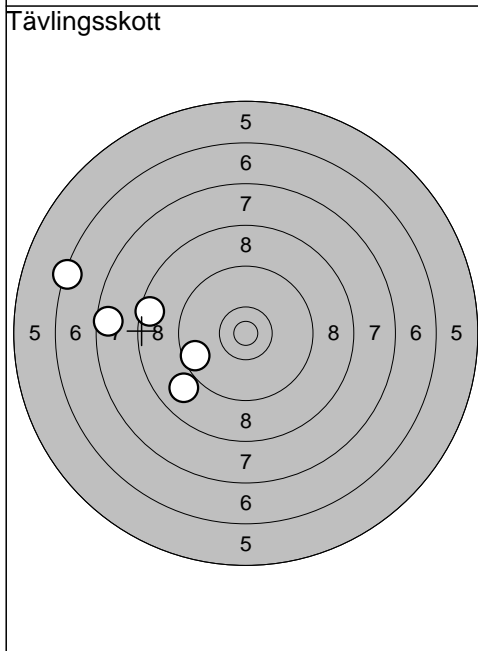

16: 9,6	↙
17: 7,6	↙
18: 8,9	↙
19: 8,6	↙
20: 6,4	↙
<hr/>	
Serie	38,0
Totalt	147,0

Ramselefors

2009-07-16

Tavelträffen 2009

Ramselefors SKF

Provskott

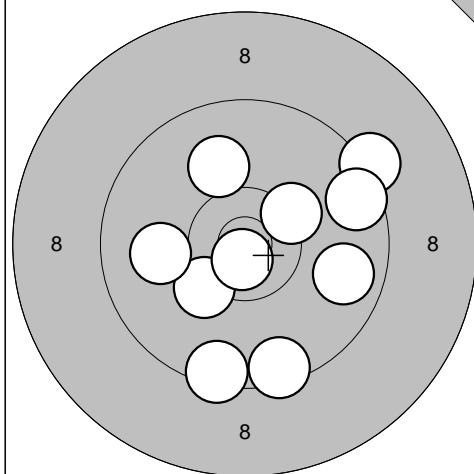

1: 10,3\* ↗  
 2: 9,3 ↗  
 3: 10,0 ↗  
 4: 10,3 ↘  
 5: 9,5 ↓  
 6: 10,0 ←  
 7: 10,8\* ↓  
 8: 9,5 ↓  
 9: 9,6 ↗  
 10: 9,8 →

Serie 95,0

Totalt 0,0

Provskott

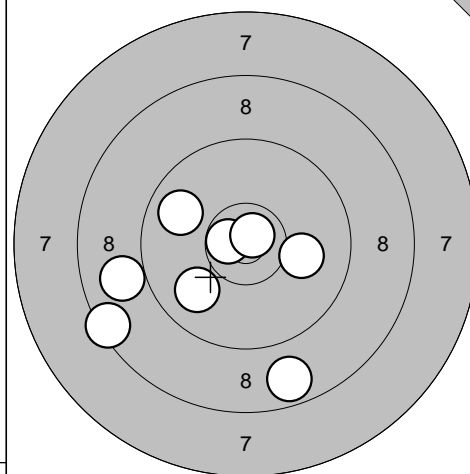

11: 9,9 ↘  
 12: 8,9 ←  
 13: 10,7\* ←  
 14: 8,4 ↘  
 15: 8,7 ↓  
 16: 9,8 ↗  
 17: 10,8\* ↗  
 18: 10,0 →

Serie 72,0

Totalt 0,0

Tävlingsskott

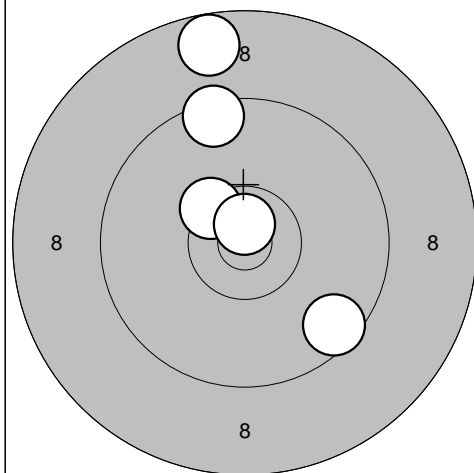

1: 10,4\* ↗  
 2: 10,7\* ↑  
 3: 8,7 ↑  
 4: 9,5 ↑  
 5: 9,6 ↓

Serie 46,0

Totalt 46,0

Tävlingsskott

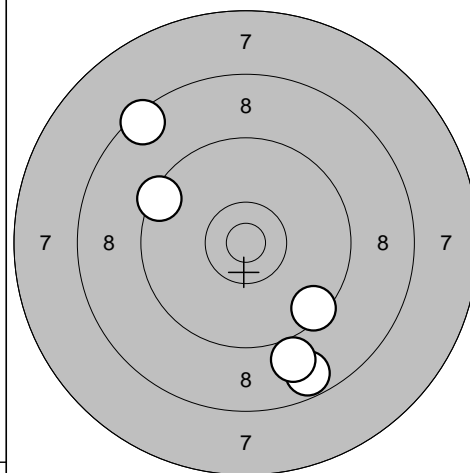

6: 8,5 ↗  
 7: 9,4 ↗  
 8: 9,5 ↓  
 9: 8,7 ↓  
 10: 9,0 ↓

Serie 43,0

Totalt 89,0

Tävlingsskott

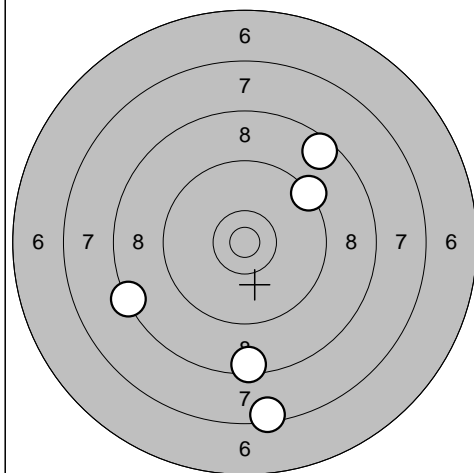

11: 7,5 ↓  
 12: 8,6 ↗  
 13: 8,4 ←  
 14: 9,3 ↗  
 15: 8,5 ↓

Serie 40,0

Totalt 129,0

Tävlingsskott

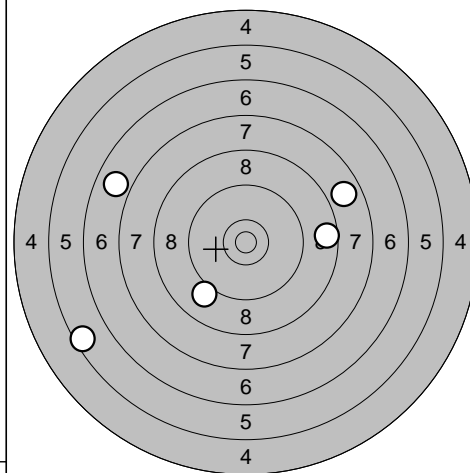

16: 7,8 ↗  
 17: 8,6 →  
 18: 9,0 ↘  
 19: 6,9 ←  
 20: 5,5 ←

Serie 35,0

Totalt 164,0

Rundvik

2009-07-16

Tavelträffen 2009

Ramselefors SKF

Provskott

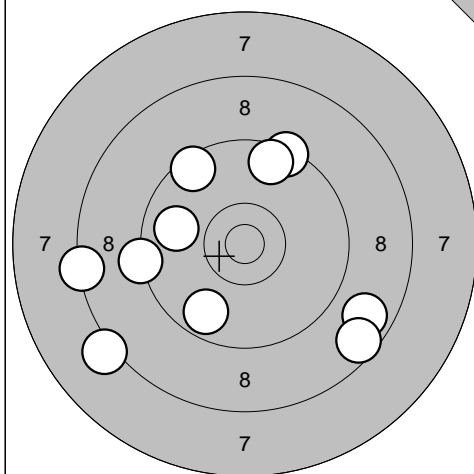

1: 8,8 ↘  
 2: 8,6 ↘  
 3: 9,4 ↗  
 4: 9,5 ↗  
 5: 9,3 ←  
 6: 8,2 ←  
 7: 9,6 ↗  
 8: 9,7 ↘  
 9: 8,4 ←  
 10: 9,9 ←

Serie 86,0

Totalt 0,0

Provskott

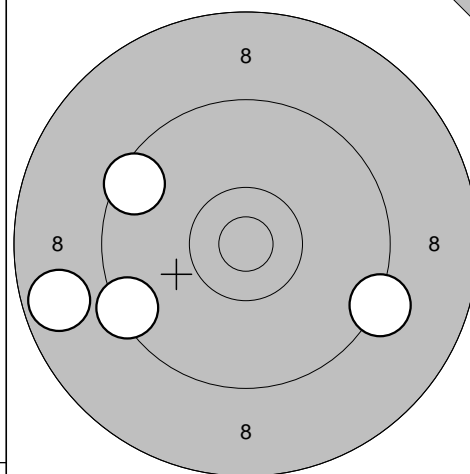

11: 8,7 ←  
 12: 9,4 ←  
 13: 9,3 ↘  
 14: 9,5 ↖

Serie 35,0

Totalt 0,0

Tävlingsskott

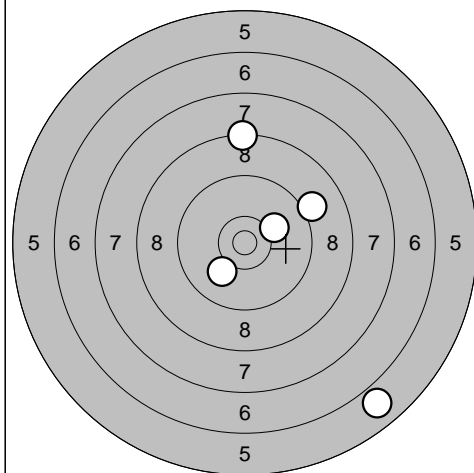

1: 5,9 ↘  
 2: 10,1 ↗  
 3: 10,1 ↘  
 4: 8,3 ↑  
 5: 9,1 ↗

Serie 42,0

Totalt 42,0

Tävlingsskott

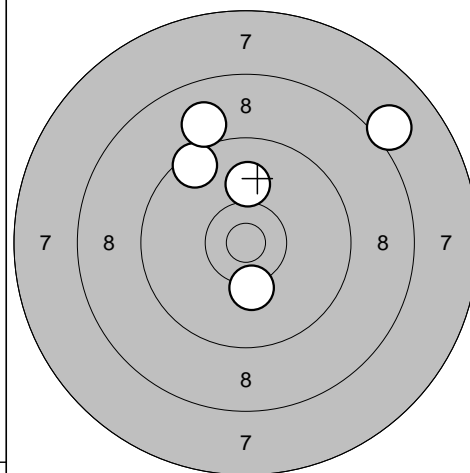

6: 10,0 ↑  
 7: 10,2 ↓  
 8: 9,5 ↗  
 9: 8,1 ↗  
 10: 9,0 ↗

Serie 46,0

Totalt 88,0

Tävlingsskott

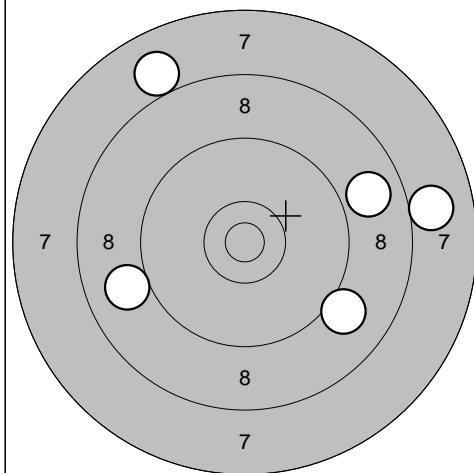

11: 9,0 ↘  
 12: 8,0 →  
 13: 8,0 ↗  
 14: 8,9 →  
 15: 9,0 ←

Serie 42,0

Totalt 130,0

Tävlingsskott

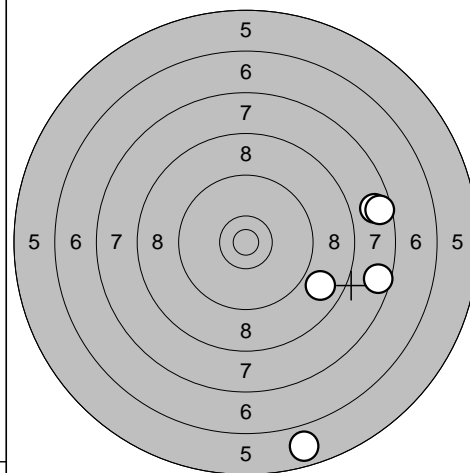

16: 7,7 →  
 17: 8,8 ↘  
 18: 7,6 →  
 19: 5,8 ↓  
 20: 7,6 →

Serie 34,0

Totalt 164,0

Lindesberg

2009-07-16

Tavelträffen 2009

Ramselefors SKF

Provskott

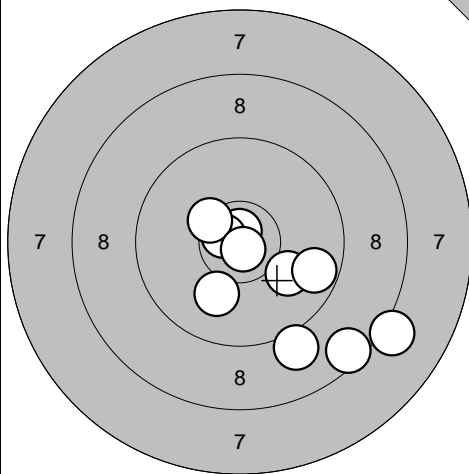

- 1: 10,8\* ↑
- 2: 8,5 ↓
- 3: 10,7\* ↖
- 4: 10,0 ↓
- 5: 10,4\* ↗
- 6: 9,1 ↓
- 7: 9,7 →
- 8: 10,8\* ↓
- 9: 10,1 ↓
- 10: 8,2 ↓

Serie 94,0  
Totalt 0,0

Provskott

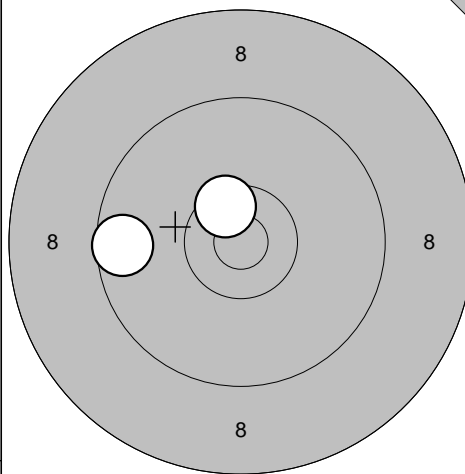

- 11: 9,6 ←
- 12: 10,5\* ↗

Serie 19,0  
Totalt 0,0

Tävlingskott

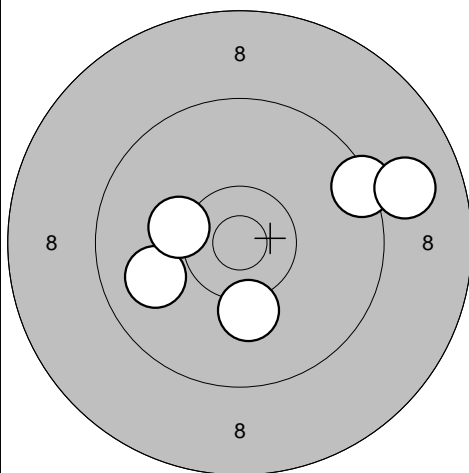

- 1: 9,9 ←
- 2: 9,4 →
- 3: 9,0 →
- 4: 10,2 ←
- 5: 10,2 ↓

Serie 47,0  
Totalt 47,0

Tävlingskott

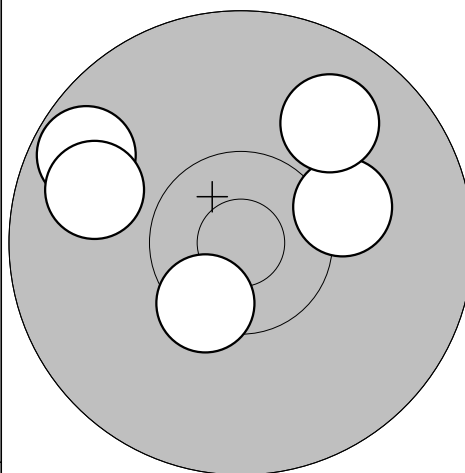

- 6: 10,2 →
- 7: 9,7 ↖
- 8: 10,4\* ↓
- 9: 9,9 ↗
- 10: 9,9 ←

Serie 47,0  
Totalt 94,0

Tävlingskott

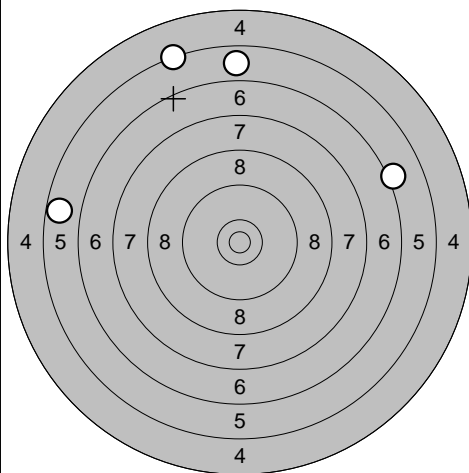

- 11: 5,8 ↑
- 12: 5,7 ←
- 13: 6,2 →
- 14: 5,3 ↗
- 15: 0,0 ↗

Serie 21,0  
Totalt 115,0

Tävlingskott

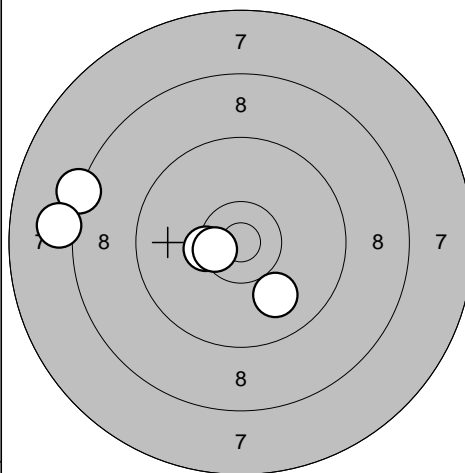

- 16: 10,0 ↓
- 17: 10,4\* ←
- 18: 8,3 ←
- 19: 8,1 ←
- 20: 10,5\* ←

Serie 46,0  
Totalt 161,0

Bälinge-Jumkil

2009-07-16

Tavelträffen 2009

Ramselefors SKF

Provsjött

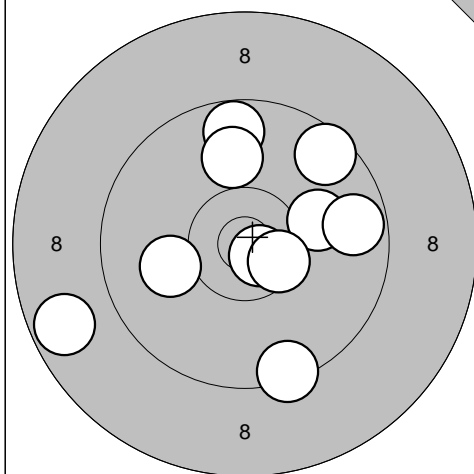

1: 9,4 ↘  
 2: 10,1 →  
 3: 9,6 ↗  
 4: 8,7 ←  
 5: 9,7 ↑  
 6: 10,7\* ↘  
 7: 10,1 ←  
 8: 9,7 →  
 9: 10,0 ↑  
 10: 10,5\* ↘

Serie 94,0

Totalt 0,0

Tävlingssjött

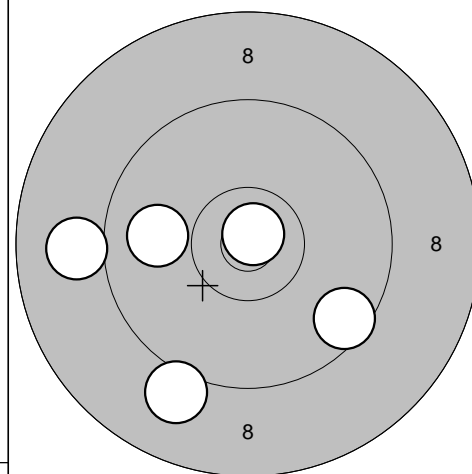

1: 9,0 ←  
 2: 9,6 ↘  
 3: 9,9 ←  
 4: 10,8\* ↗  
 5: 9,1 ↘

Serie 46,0

Totalt 46,0

Tävlingssjött

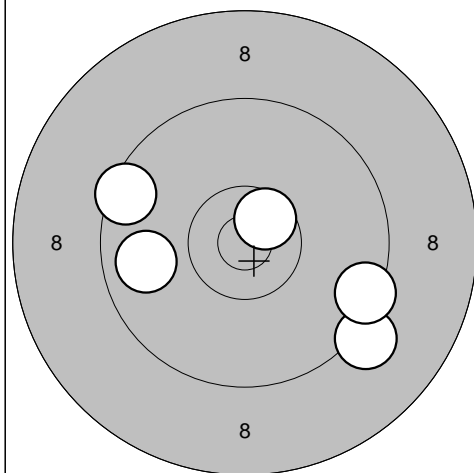

6: 10,6\* ↗  
 7: 9,2 ↘  
 8: 9,5 →  
 9: 9,5 ←  
 10: 9,8 ←

Serie 46,0

Totalt 92,0

Tävlingssjött

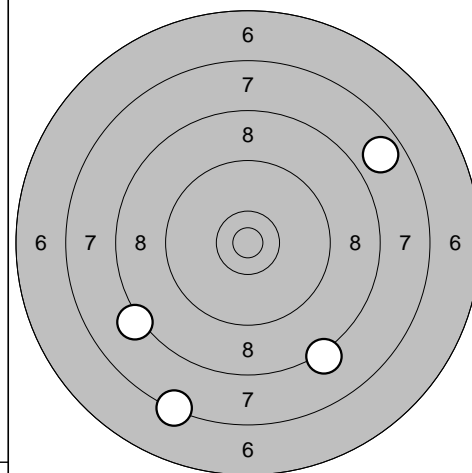

11: 8,2 ↘  
 12: 0,0 →  
 13: 8,2 ←  
 14: 7,8 ↗  
 15: 7,3 ↘

Serie 30,0

Totalt 122,0

Tävlingssjött

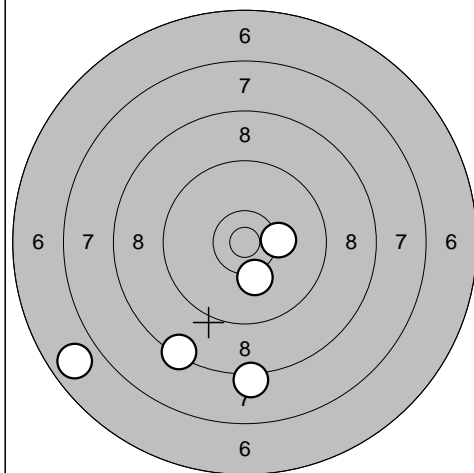

16: 8,4 ↘  
 17: 6,8 ←  
 18: 10,3 →  
 19: 10,2 ↘  
 20: 8,2 ↘

Serie 42,0

Totalt 164,0

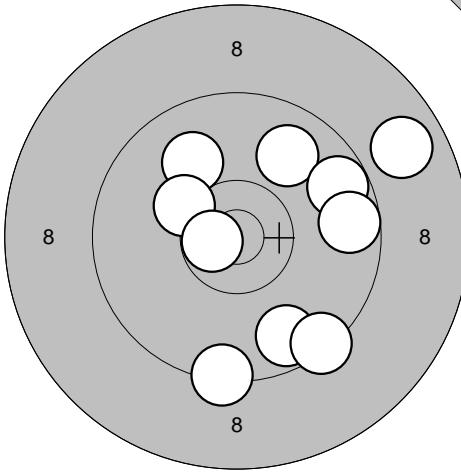
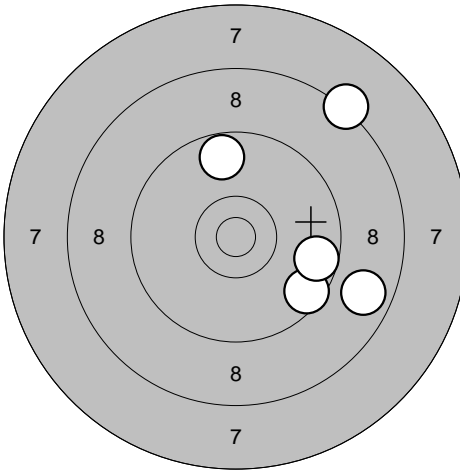
<b>Provs-kott</b> 	1: 9,9 ↗ 2: 8,8 → 3: 9,7 ↓ 4: 9,7 → 5: 9,4 ↓ 6: 9,4 ↓ 7: 10,0 ↗ 8: 10,3 ↗ 9: 9,6 → 10: 10,7* ←	<b>Tävlingsskott</b> 	1: 9,5 ↘ 2: 8,3 ↗ 3: 9,7 ↑ 4: 9,6 → 5: 8,8 ↘
Serie 92,0	Serie 43,0	Serie 43,0	
Totalt 0,0	Totalt 43,0	Totalt 43,0	

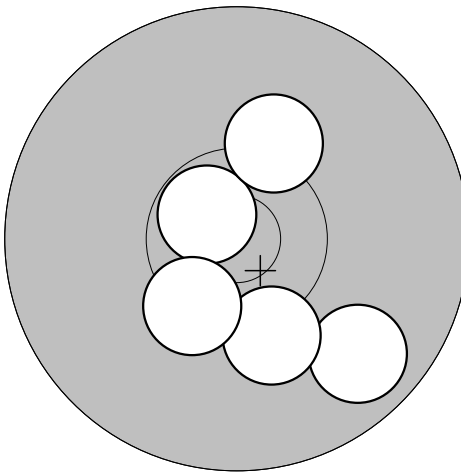
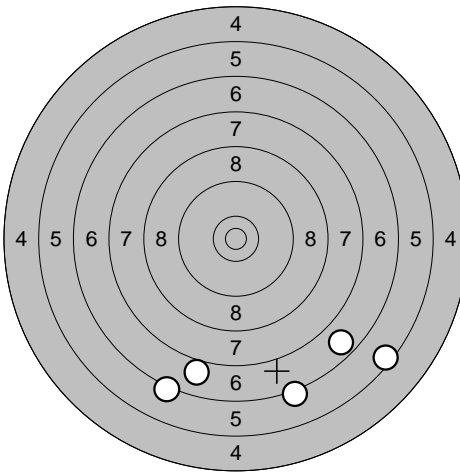
<b>Tävlingsskott</b> 	6: 10,7* ↗ 7: 9,8 ↓ 8: 10,2 ↗ 9: 10,2 ↓ 10: 10,4* ↘	<b>Tävlingsskott</b> 	11: 6,7 ↘ 12: 5,5 ↘ 13: 7,0 ↓ 14: 6,2 ↓ 15: 6,2 ↓
Serie 49,0	Serie 30,0	Serie 30,0	
Totalt 92,0	Totalt 122,0	Totalt 122,0	

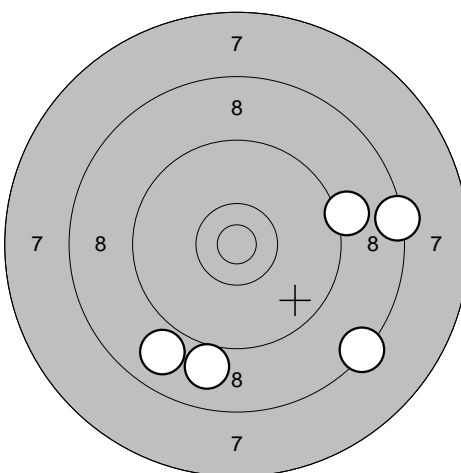
<b>Tävlingsskott</b> 	16: 8,4 ↓ 17: 8,9 ↘ 18: 9,2 → 19: 9,0 ↓ 20: 8,4 →		
Serie 42,0			
Totalt 164,0			

Ununge

2009-07-16

Tavelträffen 2009

Ramselefors SKF

Provsjött

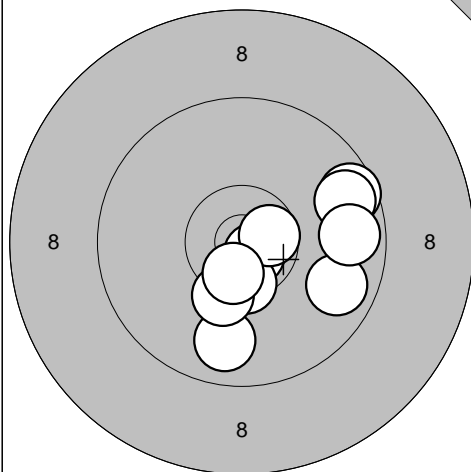

1: 9,8 ↘  
 2: 9,8 →  
 3: 9,6 →  
 4: 9,7 →  
 5: 10,7\* ↘  
 6: 10,5\* ↘  
 7: 9,7 →  
 8: 10,6\* →  
 9: 10,3\* ↘  
 10: 10,6\* ↘

Serie 95,0

Totalt 0,0

Tävlingssjött

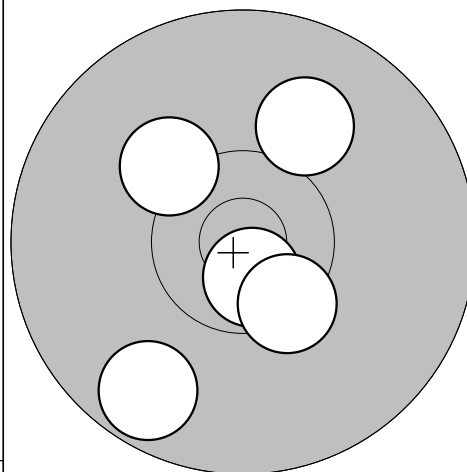

1: 10,2 ↖  
 2: 10,0 ↗  
 3: 10,7\* ↘  
 4: 10,4\* ↘  
 5: 9,7 ↘

Serie 49,0

Totalt 49,0

Tävlingssjött

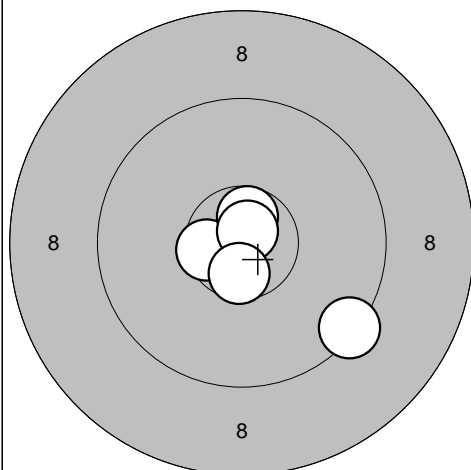

6: 9,4 ↘  
 7: 10,5\* ←  
 8: 10,6\* ↑  
 9: 10,8\* ↗  
 10: 10,6\* ↘

Serie 49,0

Totalt 98,0

Tävlingssjött

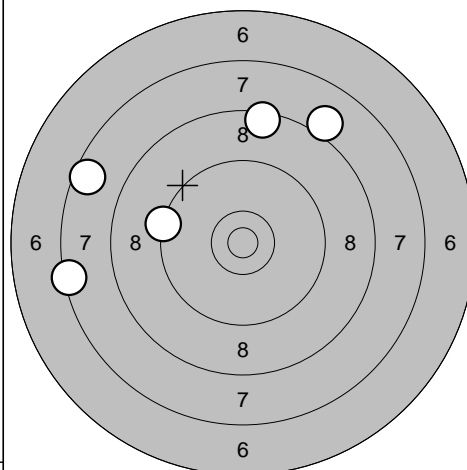

11: 9,3 ←  
 12: 7,6 ←  
 13: 7,4 ←  
 14: 8,1 ↗  
 15: 8,5 ↑

Serie 39,0

Totalt 137,0

Tävlingssjött

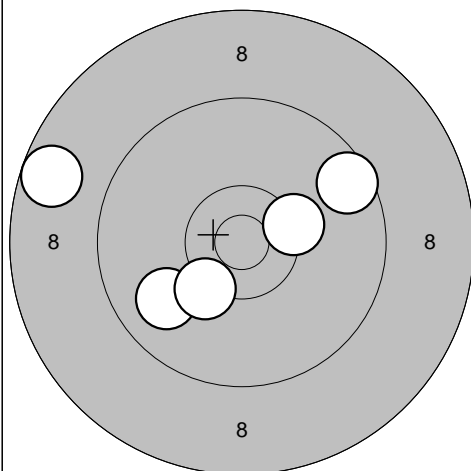

16: 9,6 →  
 17: 10,3\* →  
 18: 9,9 ↖  
 19: 10,3 ↘  
 20: 8,7 ←

Serie 46,0

Totalt 183,0

Frötuna

2009-07-16

Tavelträffen 2009

Ramselefors SKF

Provs-kott

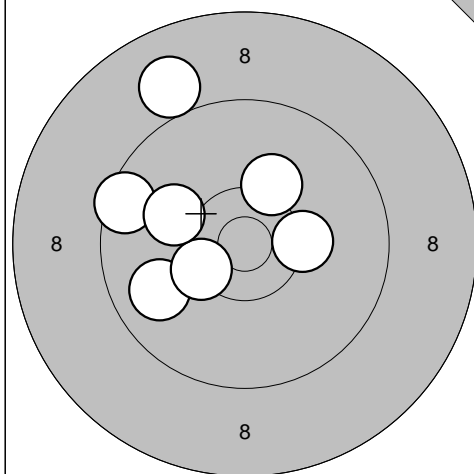

1: 9,8 ↙  
 2: 10,3 →  
 3: 9,0 ↗  
 4: 10,2 ↗  
 5: 9,5 ↙  
 6: 10,4\* ↙  
 7: 10,1 ↙

Serie 67,0

Totalt 0,0

Tävlingsskott

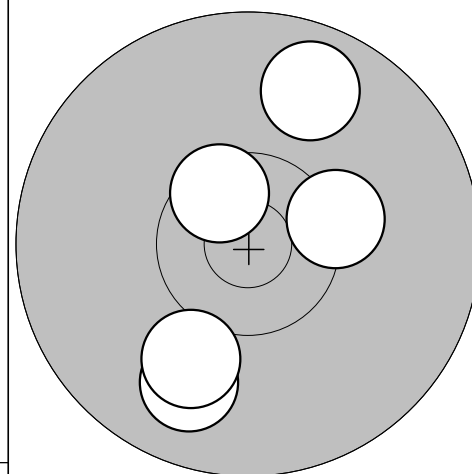

1: 10,3\* →  
 2: 9,9 ↘  
 3: 10,5\* ↗  
 4: 9,8 ↗  
 5: 10,0 ↘

Serie 48,0

Totalt 48,0

Tävlingsskott

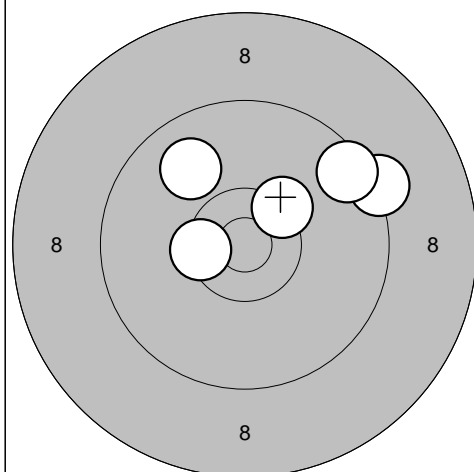

6: 10,4\* ↙  
 7: 9,3 →  
 8: 10,3\* ↗  
 9: 9,5 ↗  
 10: 9,9 ↗

Serie 47,0

Totalt 95,0

Tävlingsskott

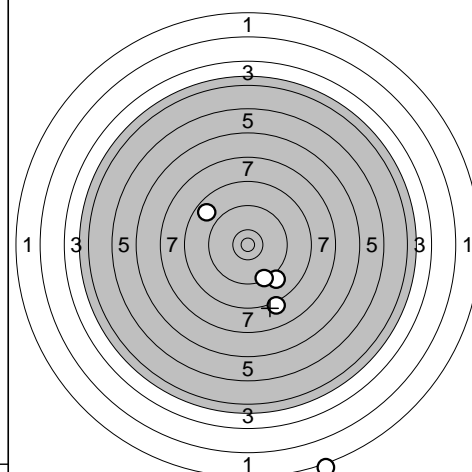

11: 8,8 ↗  
 12: 1,1 ↘  
 13: 8,2 ↘  
 14: 9,1 ↘  
 15: 9,4 ↘

Serie 35,0

Totalt 130,0

Tävlingsskott

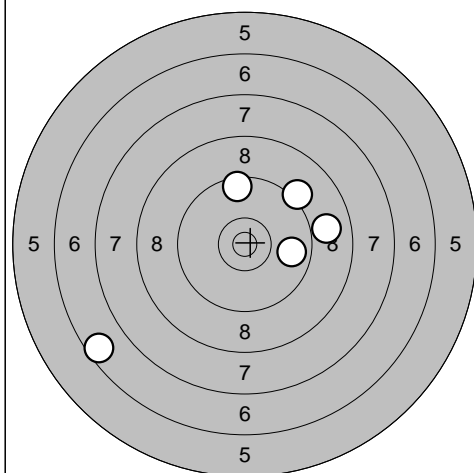

16: 8,9 →  
 17: 9,8 →  
 18: 9,2 ↗  
 19: 9,5 ↗  
 20: 6,6 ↙

Serie 41,0

Totalt 171,0



2009-07-16

Tavelträffen 2009

Ramselefors SKF

Provskott

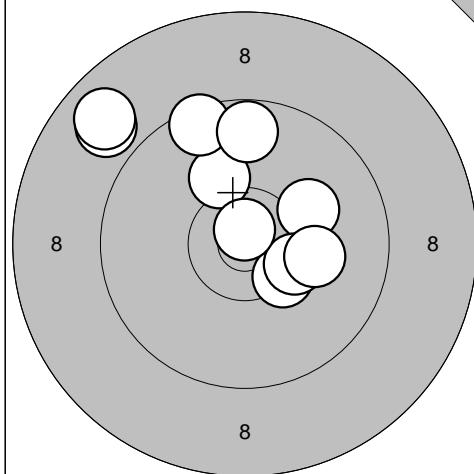

1: 10,4\* ↘  
 2: 10,1 ↗  
 3: 8,9 ↗  
 4: 10,1 →  
 5: 10,3\* →  
 6: 9,5 ↗  
 7: 8,8 ↗  
 8: 9,7 ↗  
 9: 10,8\* ↗  
 10: 10,1 →

Serie 94,0

Totalt 0,0

Provskott

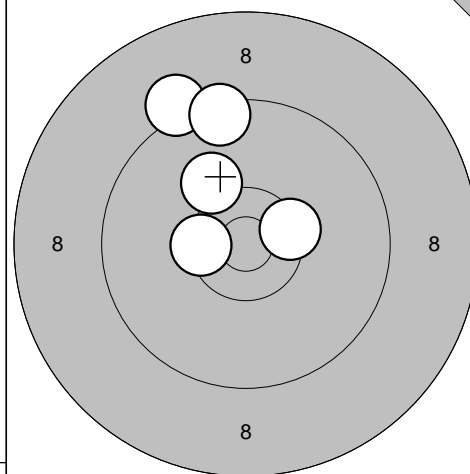

11: 9,2 ↗  
 12: 10,4\* ←  
 13: 10,4\* →  
 14: 9,5 ↗  
 15: 10,2 ↗

Serie 48,0

Totalt 0,0

Tävlingsskott

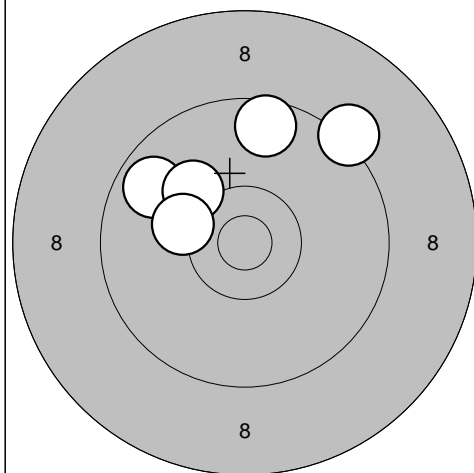

1: 9,6 ↗  
 2: 9,7 ↗  
 3: 10,1 ↗  
 4: 9,2 ↗  
 5: 10,2 ↗

Serie 47,0

Totalt 47,0

Tävlingsskott

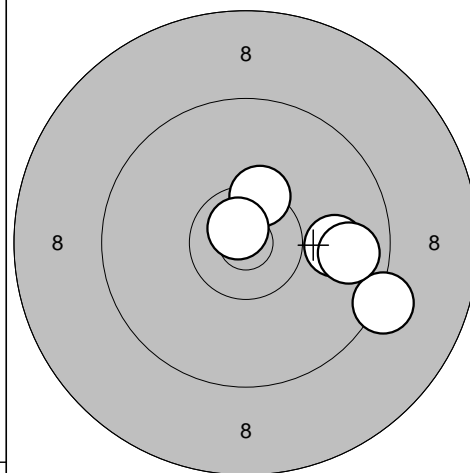

6: 10,4\* ↗  
 7: 9,2 ↗  
 8: 9,9 →  
 9: 9,8 →  
 10: 10,8\* ↗

Serie 47,0

Totalt 94,0

Tävlingsskott

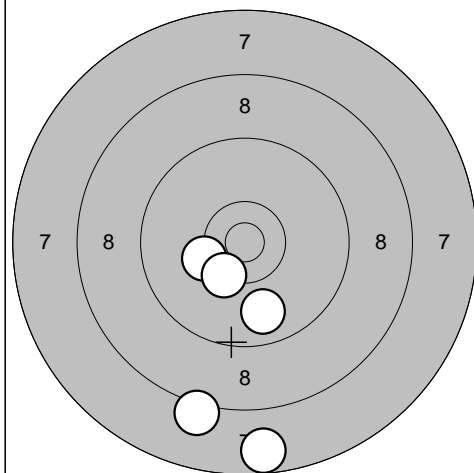

11: 7,7 ↓  
 12: 10,3 ←  
 13: 9,8 ↓  
 14: 8,2 ↓  
 15: 10,3\* ↘

Serie 44,0

Totalt 138,0

Tävlingsskott

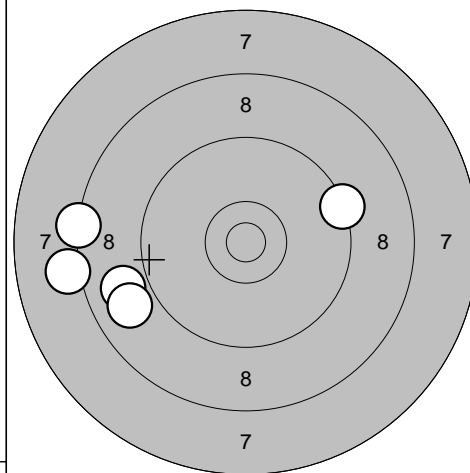

16: 8,9 ←  
 17: 8,1 ←  
 18: 9,3 →  
 19: 8,3 ←  
 20: 8,9 ←

Serie 41,0

Totalt 179,0

2009-07-16

Tavelträffen 2009

Ramselefors SKF

Provs-kott

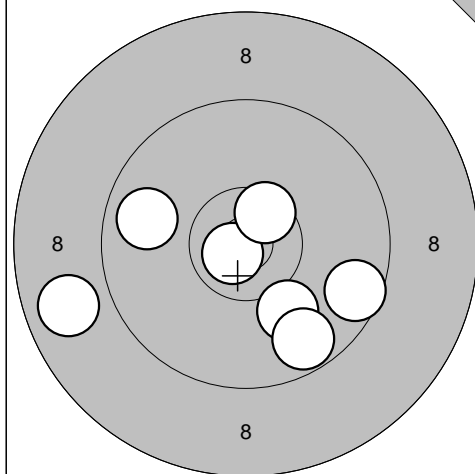

1: 8,8 ←  
 2: 9,8 ←  
 3: 9,6 →  
 4: 10,0 ↓  
 5: 9,7 ↓  
 6: 10,8\* ←  
 7: 10,5\* ↗

Serie 65,0

Totalt 0,0

Tävlingsskott

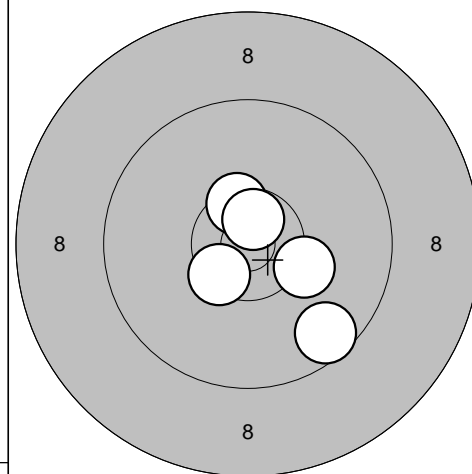

1: 10,2 →  
 2: 10,5\* ↑  
 3: 9,6 ↓  
 4: 10,5\* ↙  
 5: 10,7\* ↑

Serie 49,0

Totalt 49,0

Tävlingsskott

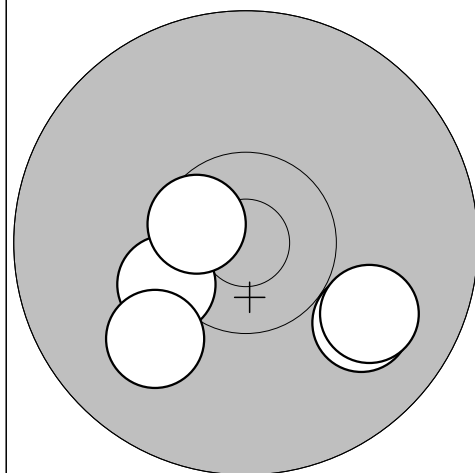

6: 9,9 ↓  
 7: 9,9 ↓  
 8: 10,3\* ←  
 9: 10,0 ↙  
 10: 10,6\* ←

Serie 48,0

Totalt 97,0

Tävlingsskott

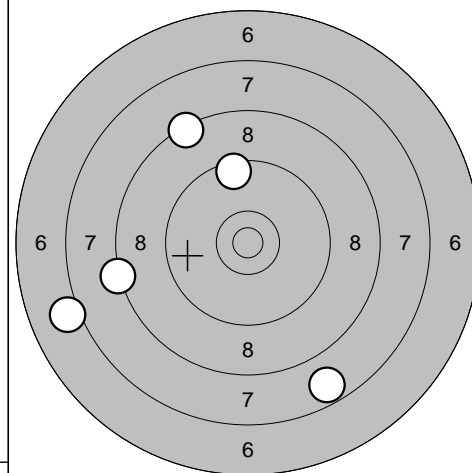

11: 8,3 ←  
 12: 7,1 ←  
 13: 7,7 ↓  
 14: 9,5 ↑  
 15: 8,4 ↗

Serie 39,0

Totalt 136,0

Tävlingsskott

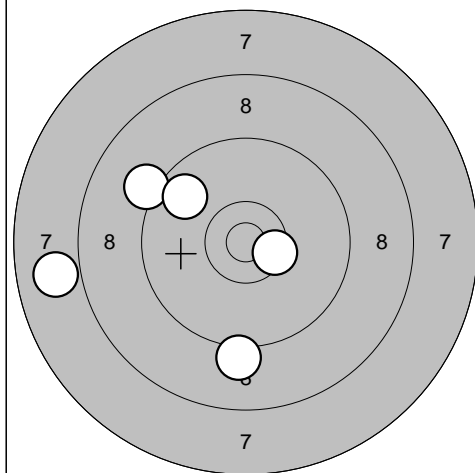

16: 9,2 ↗  
 17: 7,9 ←  
 18: 10,5\* →  
 19: 9,1 ↓  
 20: 9,8 ↗

Serie 44,0

Totalt 180,0

2009-07-16

Tavelträffen 2009

Ramselefors SKF

Provskott

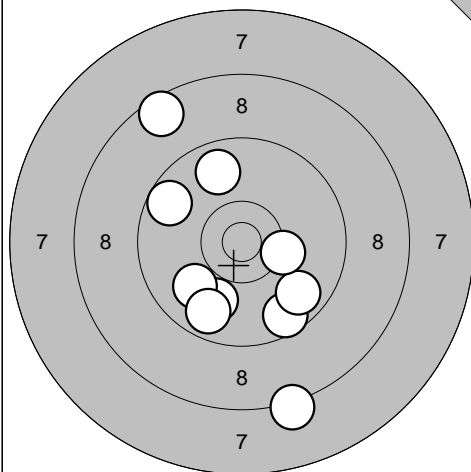

1: 8,6 ↗  
 2: 9,6 ↘  
 3: 8,2 ↘  
 4: 9,9 ↘  
 5: 9,9 ↘  
 6: 9,7 ↗  
 7: 9,7 ↘  
 8: 10,3 →  
 9: 9,8 ↗  
 10: 9,7 ↘

Serie 89,0

Totalt 0,0

Provskott

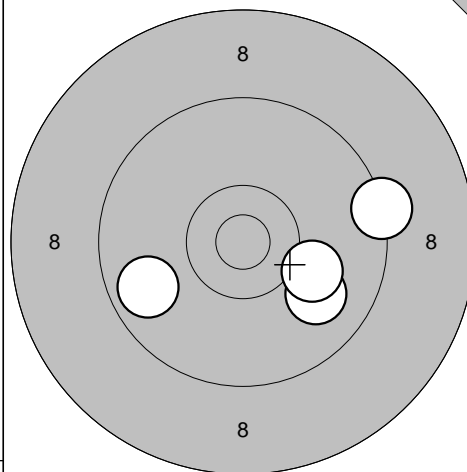

11: 9,9 ↘  
 12: 10,1 ↘  
 13: 9,3 →  
 14: 9,8 ↙

Serie 37,0

Totalt 0,0

Tävlingsskott

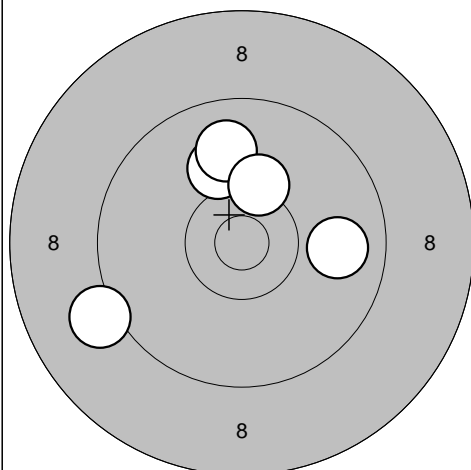

1: 9,1 ↙  
 2: 10,1 ↗  
 3: 9,9 ↗  
 4: 10,3 ↗  
 5: 9,9 →

Serie 47,0

Totalt 47,0

Tävlingsskott

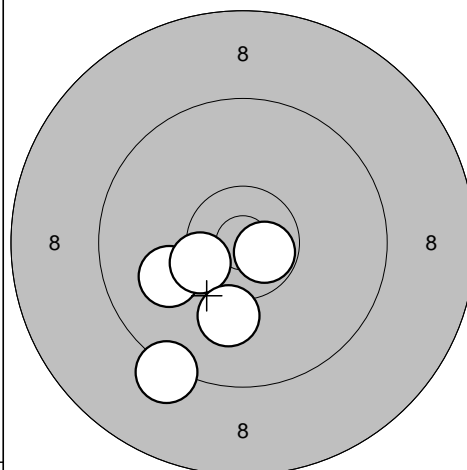

6: 10,7\* →  
 7: 10,0 ↙  
 8: 10,4\* ↙  
 9: 9,2 ↘  
 10: 10,1 ↘

Serie 49,0

Totalt 96,0

Tävlingsskott

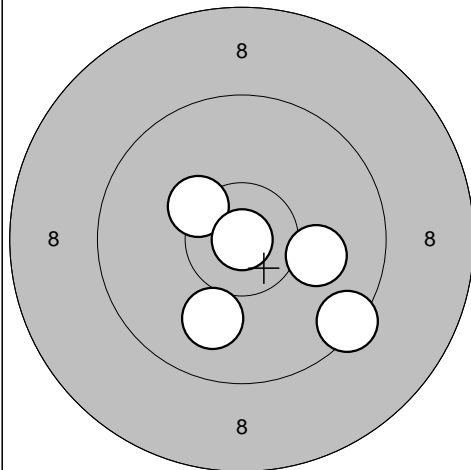

11: 10,3\* ↗  
 12: 10,1 →  
 13: 9,4 ↘  
 14: 10,9\* ↘  
 15: 10,0 ↘

Serie 49,0

Totalt 145,0

Tävlingsskott

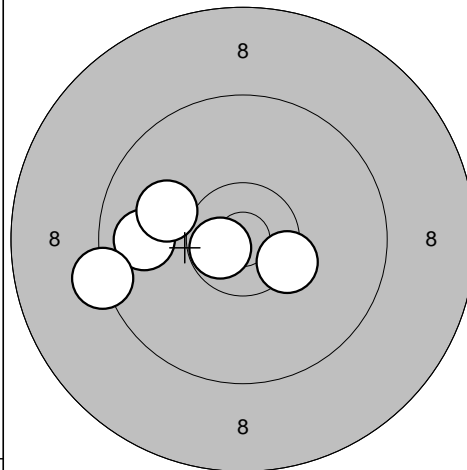

16: 9,8 ↙  
 17: 10,0 ↙  
 18: 10,7\* ↙  
 19: 9,3 ↙  
 20: 10,4\* ↘

Serie 48,0

Totalt 193,0

Ramselefors

2009-07-16

Tavelträffen 2009

Ramselefors SKF

Provs-kott

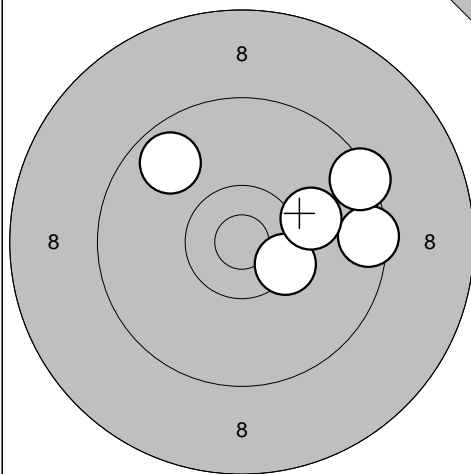

- 1: 9,7 ↖
- 2: 10,4\* ➤
- 3: 9,5 ➔
- 4: 9,4 ➤
- 5: 10,1 ➔

Serie 47,0

Totalt 0,0

Tävlingsskott

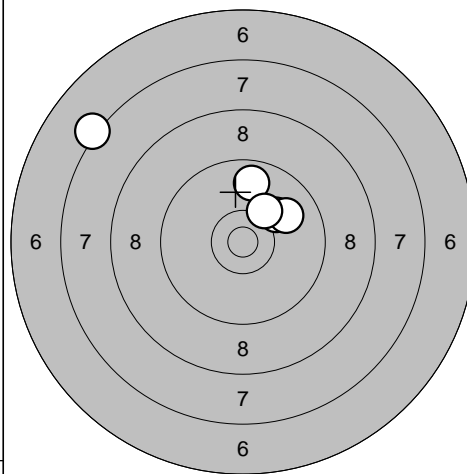

- 1: 7,2 ↖
- 2: 10,1 ↗
- 3: 9,8 ↑
- 4: 9,9 ↗
- 5: 10,2 ↗

Serie 45,0

Totalt 45,0

Tävlingsskott

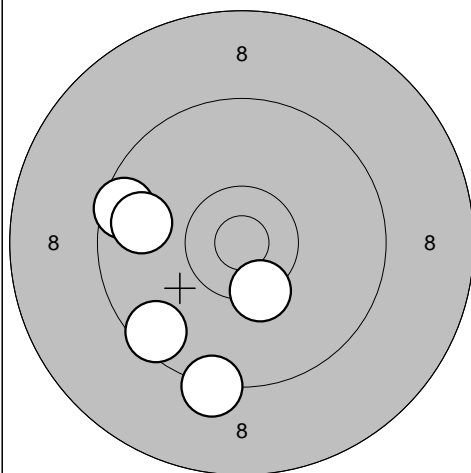

- 6: 10,4\* ↓
- 7: 9,6 ←
- 8: 9,8 ←
- 9: 9,3 ↓
- 10: 9,5 ↙

Serie 46,0

Totalt 91,0

Tävlingsskott

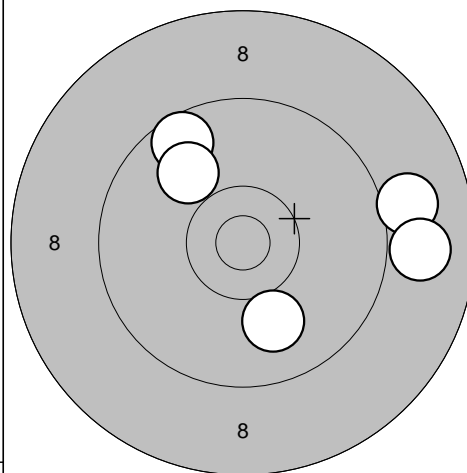

- 11: 9,6 ↗
- 12: 9,0 ➔
- 13: 10,0 ↓
- 14: 9,9 ↗
- 15: 8,9 ➔

Serie 45,0

Totalt 136,0

Tävlingsskott

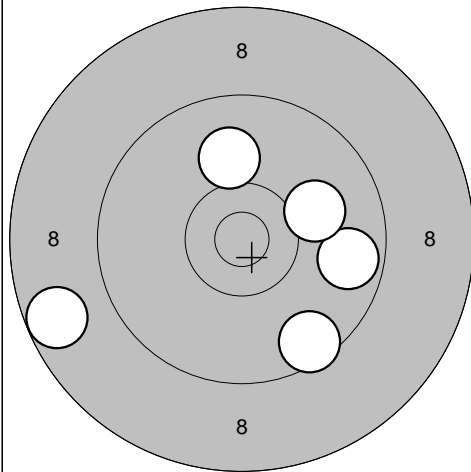

- 16: 9,5 ↓
- 17: 9,7 ➔
- 18: 8,7 ←
- 19: 10,1 ➔
- 20: 10,0 ↑

Serie 46,0

Totalt 182,0

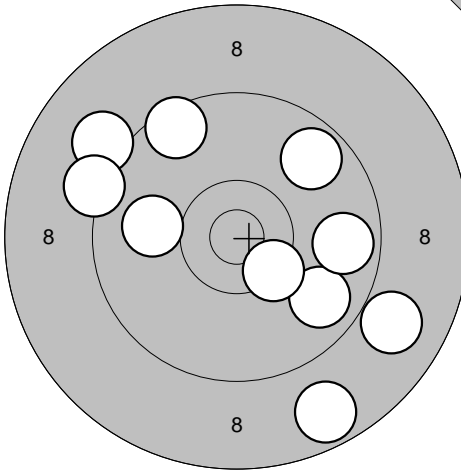
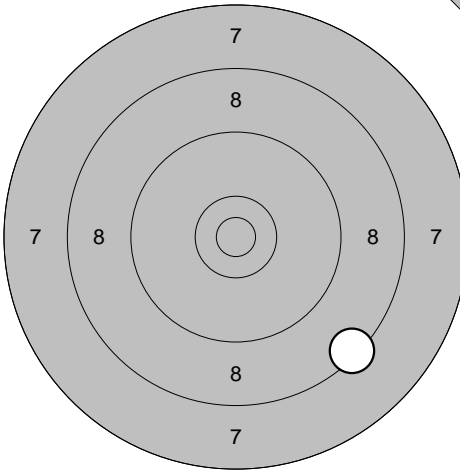
<p>Provskott</p> 	<p>1: 8,9 ↘ 2: 9,8 ↘ 3: 8,7 ↘ 4: 10,4* ↘ 5: 9,1 ↗ 6: 10,0 ← 7: 9,7 → 8: 9,2 ← 9: 9,7 ↗ 10: 9,5 ↗</p>	<p>Provskott</p> 	<p>11: 8,4 ↘</p>
Serie 90,0		Serie 8,0	
Totalt 0,0		Totalt 0,0	

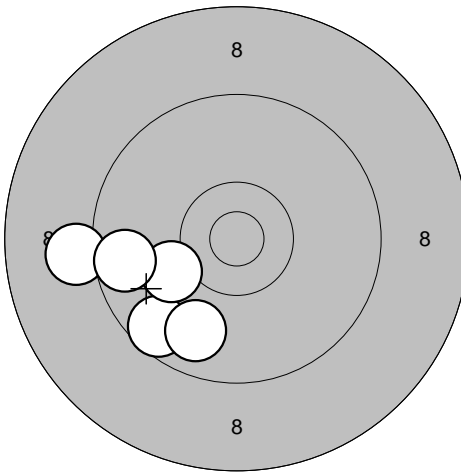
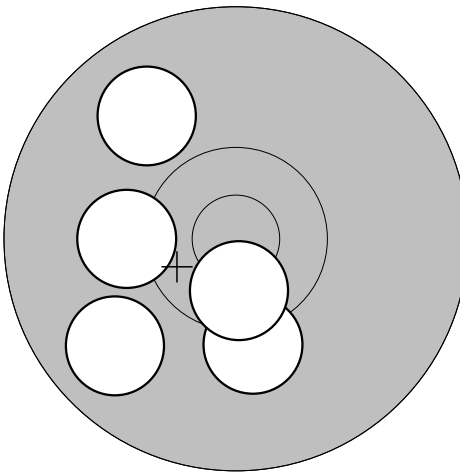
<p>Tävlingsskott</p> 	<p>1: 9,6 ↘ 2: 9,8 ↘ 3: 9,1 ← 4: 10,1 ← 5: 9,7 ←</p>	<p>Tävlingsskott</p> 	<p>6: 10,2 ↓ 7: 9,9 ↗ 8: 10,2 ← 9: 9,8 ↘ 10: 10,6* ↓</p>
Serie 46,0		Serie 48,0	
Totalt 46,0		Totalt 94,0	

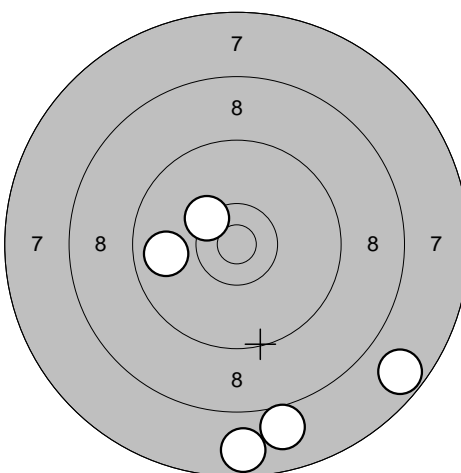
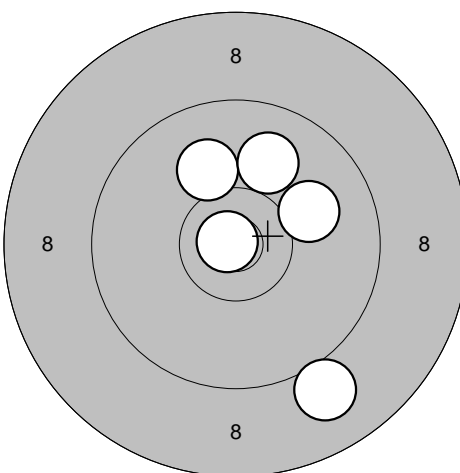
<p>Tävlingsskott</p> 	<p>11: 9,8 ← 12: 7,7 ↓ 13: 10,3* ↗ 14: 8,0 ↓ 15: 7,7 ↓</p>	<p>Tävlingsskott</p> 	<p>16: 10,0 ↗ 17: 10,0 ↗ 18: 10,0 ↗ 19: 9,0 ↓ 20: 10,8* ←</p>
Serie 41,0		Serie 49,0	
Totalt 135,0		Totalt 184,0	

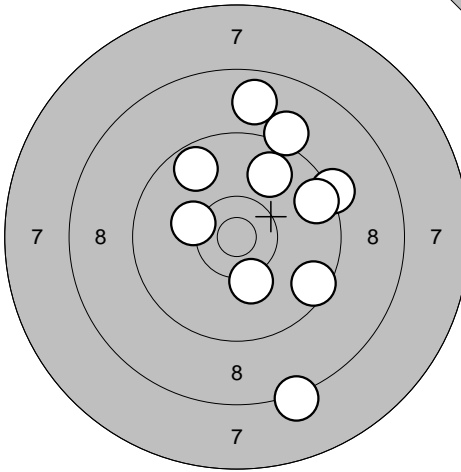
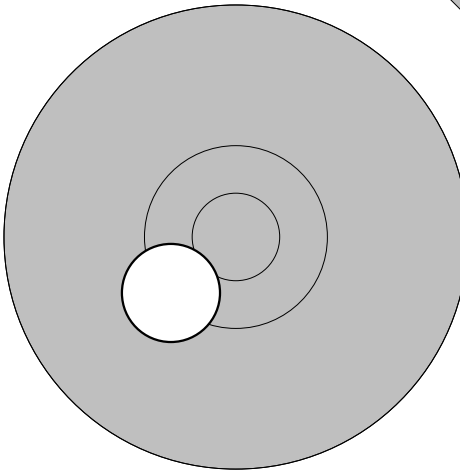
Provsjött 	1: 8,2 ↓ 2: 10,2 ← 3: 10,2 ↓ 4: 9,8 ↑ 5: 9,5 ↓ 6: 9,7 ↑ 7: 9,1 ↑ 8: 9,3 → 9: 8,8 ↑ 10: 9,6 → <hr/> Serie 90,0 Totalt 0,0	Provsjött  11: 10,3* ↙ <hr/> Serie 10,0 Totalt 0,0
---	---	---

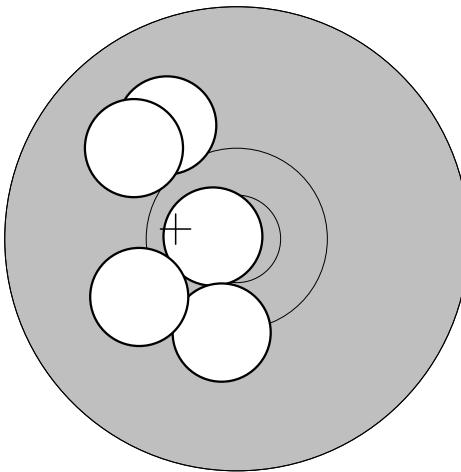
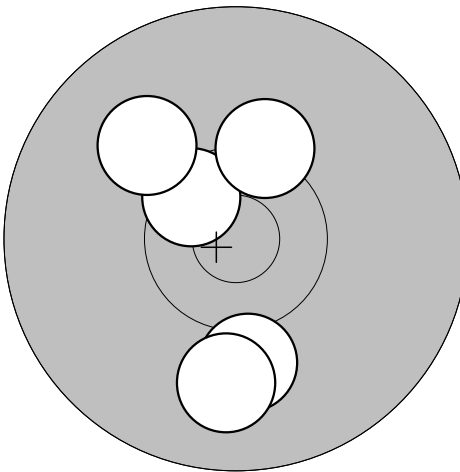
Tävlingsjött 	1: 10,0 ↑ 2: 10,8* ← 3: 10,3 ↓ 4: 10,1 ← 5: 10,0 ↑ <hr/> Serie 50,0 Totalt 50,0	Tävlingsjött  6: 10,5* ↖ 7: 10,3 ↑ 8: 10,1 ↓ 9: 10,0 ↖ 10: 9,9 ↓ <hr/> Serie 49,0 Totalt 99,0
---	---	---

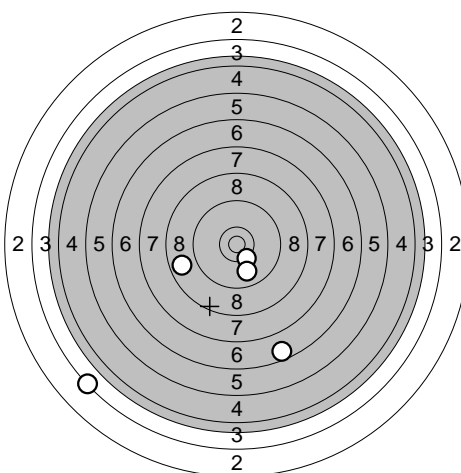
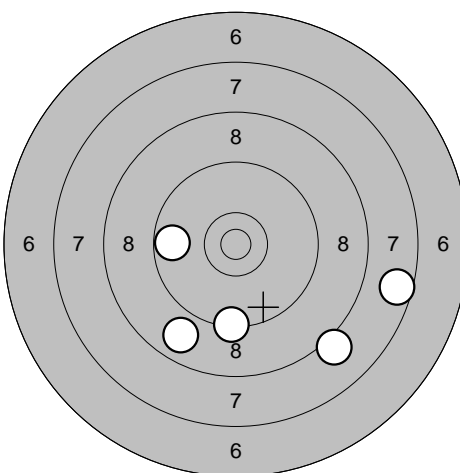
Tävlingsjött 	11: 10,3 ↓ 12: 6,6 ↓ 13: 9,9 ↓ 14: 3,3 ↙ 15: 8,8 ← <hr/> Serie 36,0 Totalt 135,0	Tävlingsjött  16: 8,8 ↙ 17: 7,6 → 18: 8,1 ↙ 19: 9,7 ← 20: 9,3 ↓ <hr/> Serie 41,0 Totalt 176,0
--	--	--

Ramselefors

2009-07-16

Tavelträffen 2009

Ramselefors SKF

Provskott

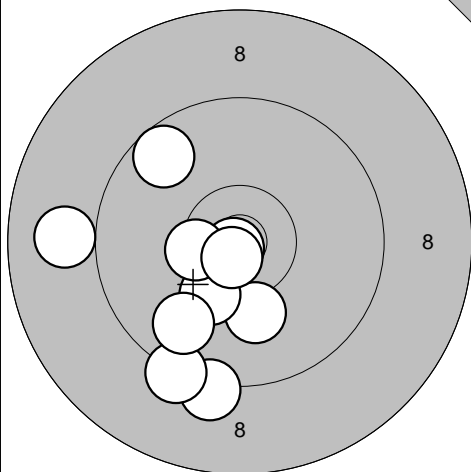

1: 9,2 ↓  
 2: 9,6 ↗  
 3: 10,1 ↓  
 4: 9,0 ←  
 5: 9,3 ↓  
 6: 10,8\* ↘  
 7: 10,3 ↓  
 8: 10,4\* ←  
 9: 10,8\* ↓  
 10: 9,8 ↘

Serie 95,0

Totalt 0,0

Provskott

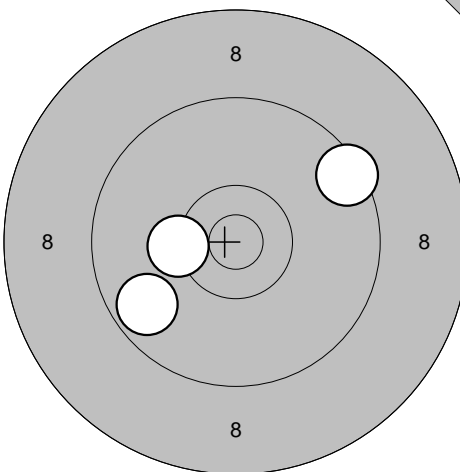

11: 9,7 ↙  
 12: 9,5 ↗  
 13: 10,3\* ←

Serie 28,0

Totalt 0,0

Tävlingskott

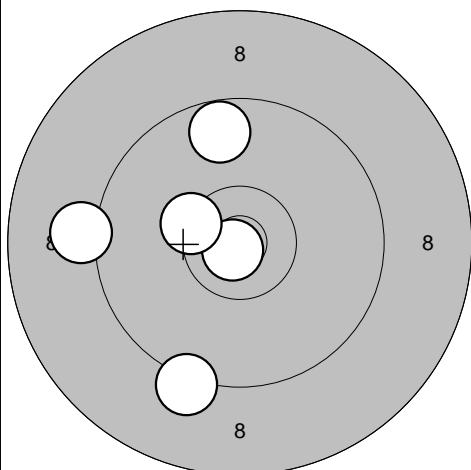

1: 9,7 ↑  
 2: 10,8\* ↘  
 3: 10,4\* ↖  
 4: 9,1 ←  
 5: 9,2 ↓

Serie 47,0

Totalt 47,0

Tävlingskott

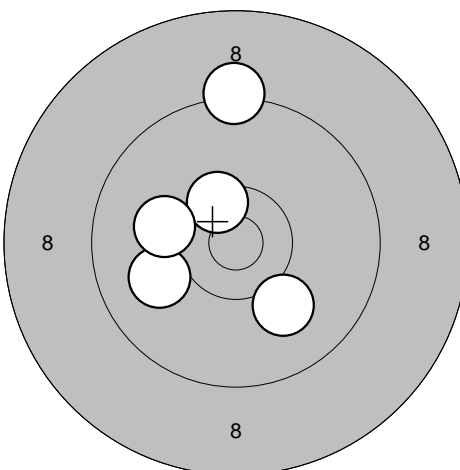

6: 10,4\* ↗  
 7: 10,1 ↘  
 8: 9,3 ↑  
 9: 10,0 ←  
 10: 10,1 ←

Serie 49,0

Totalt 96,0

Tävlingskott

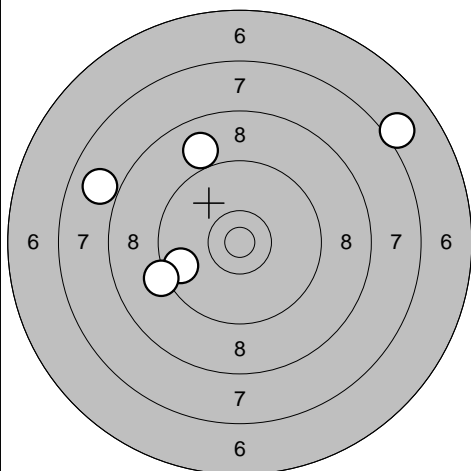

11: 9,7 ←  
 12: 9,2 ←  
 13: 9,0 ↑  
 14: 7,1 ↗  
 15: 7,9 ←

Serie 41,0

Totalt 137,0

Tävlingskott

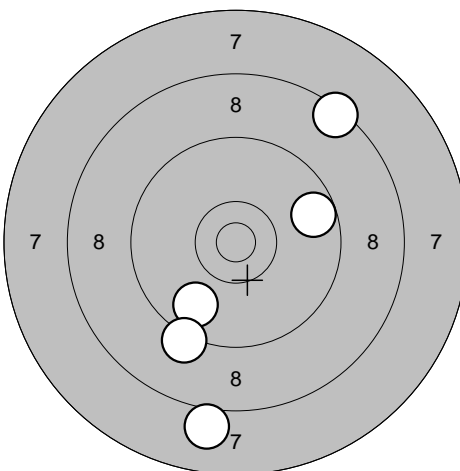

16: 8,4 ↗  
 17: 9,7 ↗  
 18: 9,8 ↘  
 19: 9,2 ↘  
 20: 8,0 ↓

Serie 43,0

Totalt 180,0

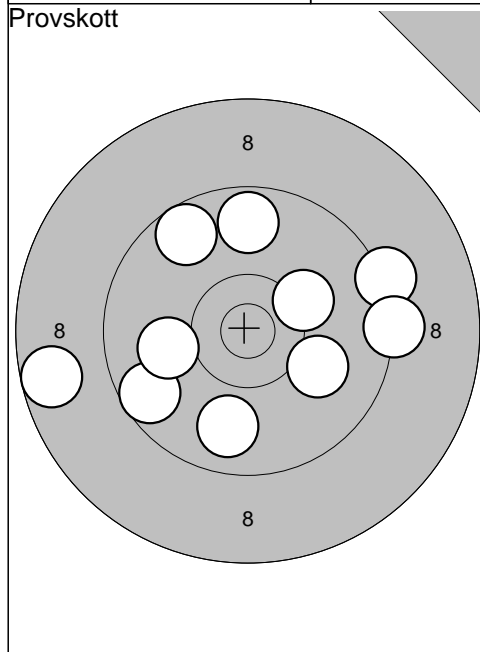

1: 8,7	←
2: 9,6	↙
3: 9,6	↗
4: 10,0	←
5: 9,3	→
6: 9,3	→
7: 9,7	↑
8: 9,8	↓
9: 10,0	↘
10: 10,2	↗
Serie	92,0
Totalt	0,0

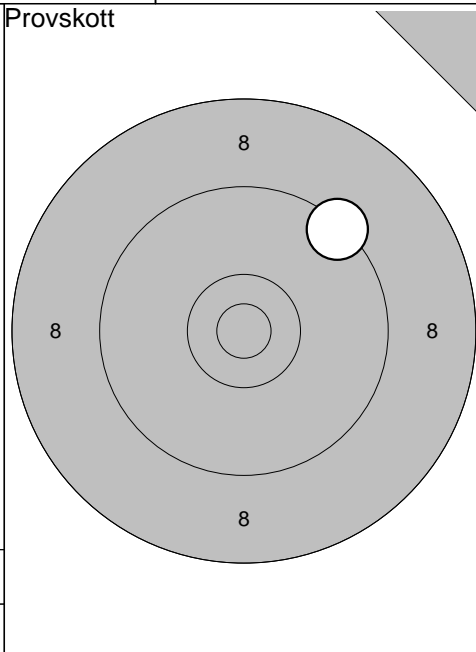

11: 9,4	↗
Serie	9,0
Totalt	0,0

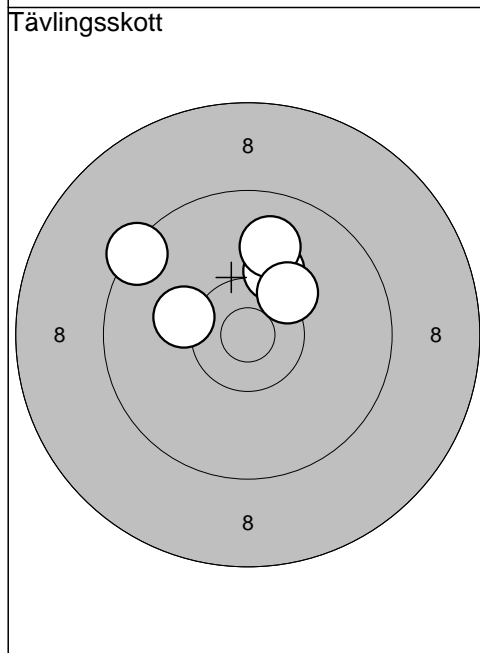

1: 9,4	↖
2: 10,2	↗
3: 10,2	←
4: 9,9	↑
5: 10,3*	↗
Serie	48,0
Totalt	48,0

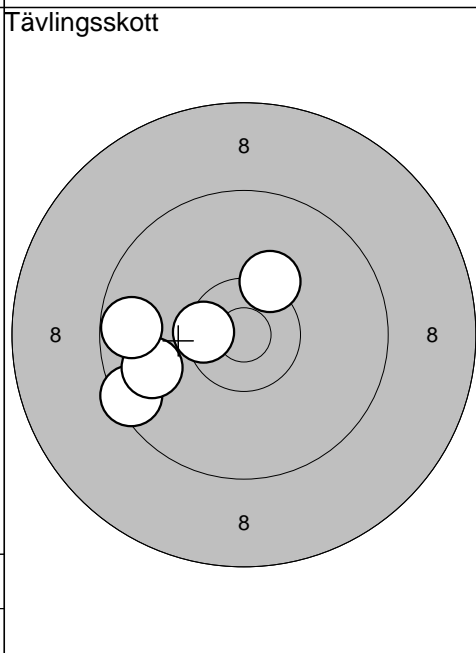

6: 9,5	↙
7: 9,8	↙
8: 10,3	↗
9: 9,7	←
10: 10,5*	←
Serie	47,0
Totalt	95,0

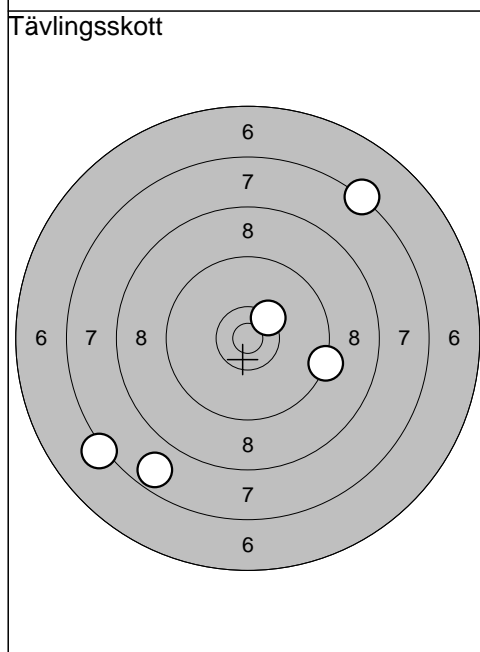

11: 10,4*	↗
12: 7,3	↗
13: 7,2	↙
14: 7,7	↙
15: 9,3	→
Serie	40,0
Totalt	135,0

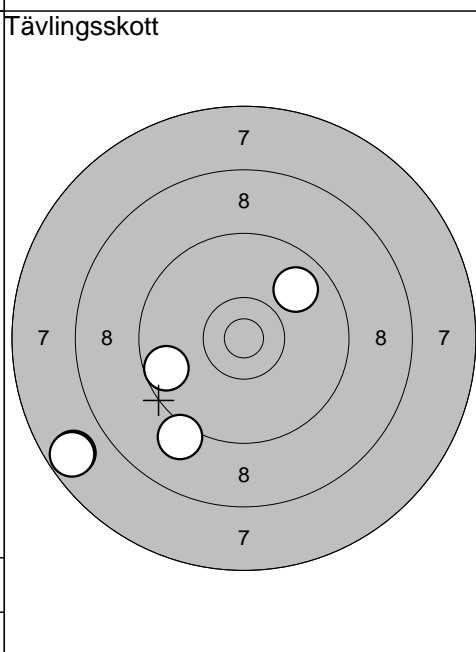

16: 9,1	↘
17: 9,6	↙
18: 7,7	↙
19: 9,8	↗
20: 7,7	↙
Serie	41,0
Totalt	176,0

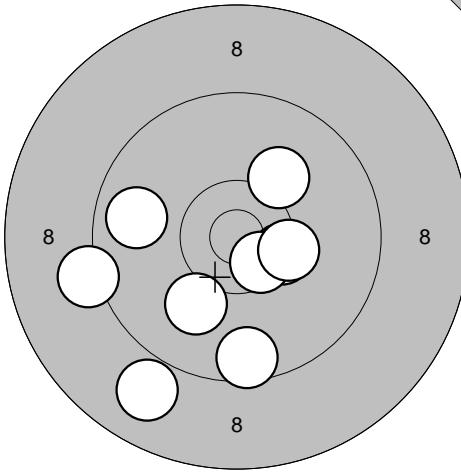
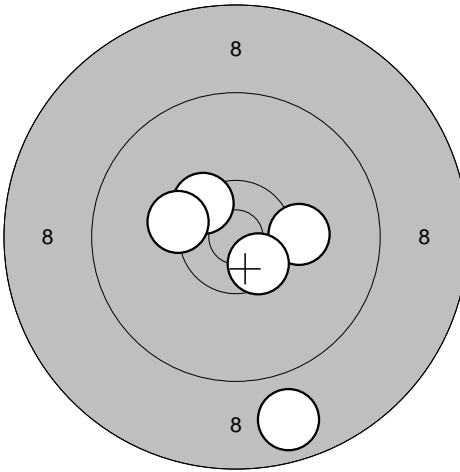

<p>Provsjött</p> 	<p>Tävlingssjött</p> 	
1: 10,4* → 2: 10,5* ↓ 3: 10,3* → 4: 9,2 ← 5: 9,6 ↓ 6: 10,1 ↗ 7: 9,8 ← 8: 8,9 ↓ 9: 10,1 ↓	1: 10,2 → 2: 10,5* ↓ 3: 10,4* ↗ 4: 10,3 ← 5: 8,8 ↓	
Serie 85,0	Serie 48,0	
Totalt 0,0	Totalt 48,0	

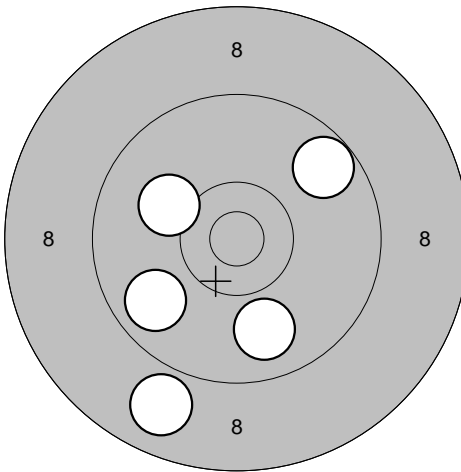
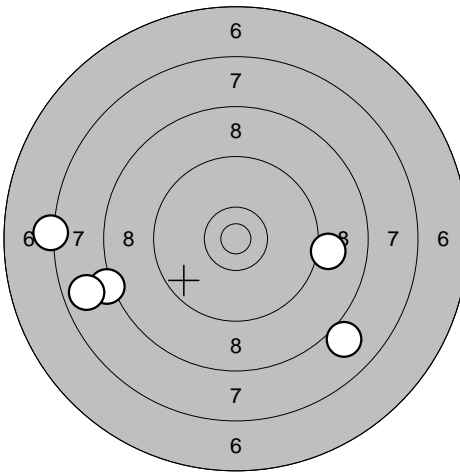
<p>Tävlingssjött</p> 	<p>Tävlingssjött</p> 	
6: 9,8 ↙ 7: 8,9 ↓ 8: 9,9 ↓ 9: 9,7 ↗ 10: 10,1 ↖	11: 7,3 ← 12: 8,2 ← 13: 7,8 ← 14: 8,0 ↓ 15: 9,1 →	
Serie 45,0	Serie 39,0	
Totalt 93,0	Totalt 132,0	

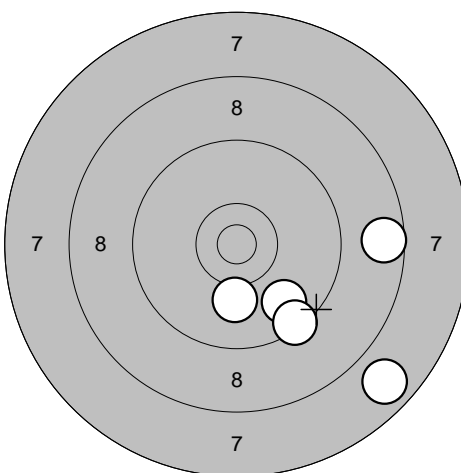
<p>Tävlingssjött</p> 		
16: 9,8 ↓ 17: 8,6 → 18: 10,1 ↓ 19: 9,4 ↓ 20: 7,8 ↓		
Serie 43,0		
Totalt 175,0		

Provskott

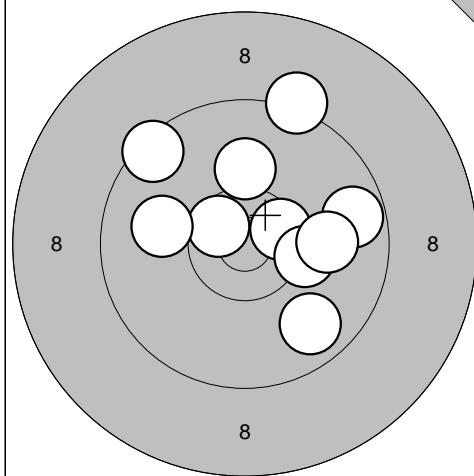

- 1: 9,7 →
- 2: 10,6\* ↗
- 3: 10,1 ↑
- 4: 10,5\* →
- 5: 9,5 ↗
- 6: 10,2 →
- 7: 9,8 ↘
- 8: 10,0 →
- 9: 10,0 ←
- 10: 9,2 ↗

Serie 96,0  
Totalt 0,0

Provskott

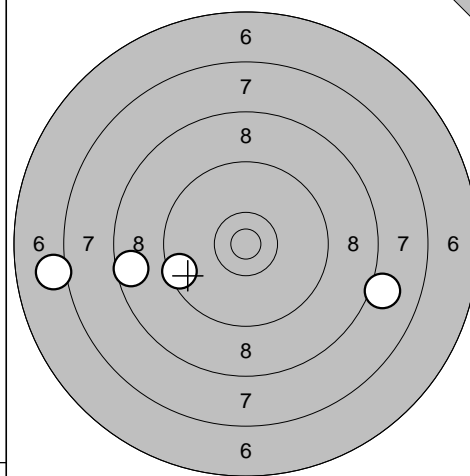

- 11: 9,5 ←
- 12: 8,1 →
- 13: 8,6 ←
- 14: 7,1 ←

Serie 32,0  
Totalt 0,0

Tävlingskott

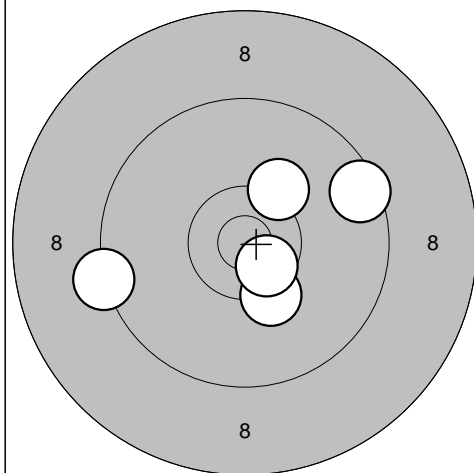

- 1: 9,5 →
- 2: 10,3 ↘
- 3: 10,2 ↗
- 4: 10,6\* ↘
- 5: 9,3 ←

Serie 48,0  
Totalt 48,0

Tävlingskott

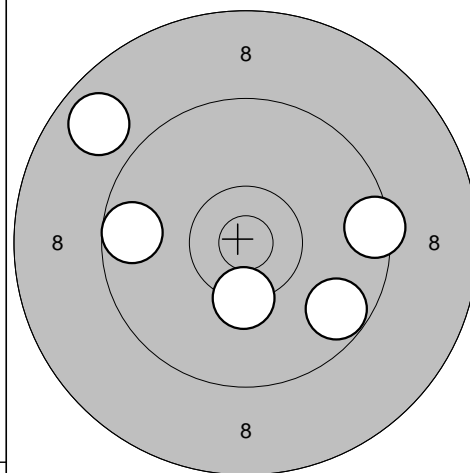

- 6: 8,8 ↖
- 7: 9,7 ←
- 8: 10,3\* ↓
- 9: 9,5 →
- 10: 9,7 ↘

Serie 45,0  
Totalt 93,0

Tävlingskott

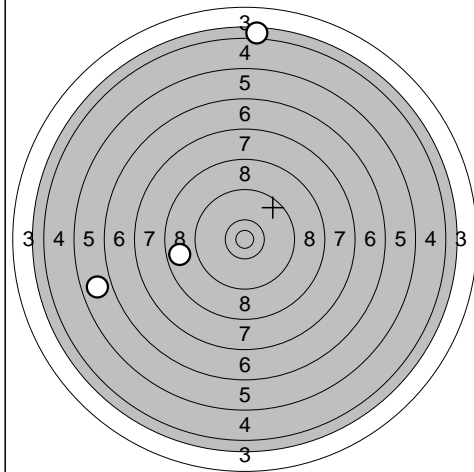

- 11: 4,2 ↑
- 12: 0,0 →
- 13: 8,8 ←
- 0,0 ↘
- 15: 5,9 ←

Serie 17,0  
Totalt 110,0

Tävlingskott

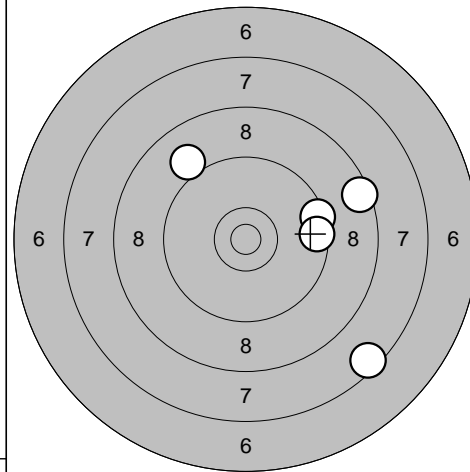

- 16: 7,5 ↘
- 17: 9,4 →
- 18: 9,0 ↗
- 19: 9,5 →
- 20: 8,5 →

Serie 42,0  
Totalt 152,0

Skellefteå

2009-07-16

Tavelträffen 2009

Ramselefors SKF

Provskott

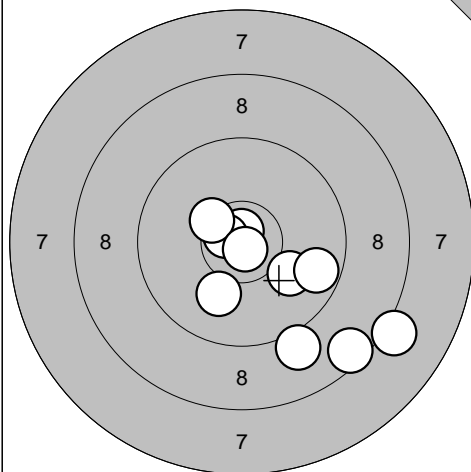

1: 10,8\* ↑  
 2: 8,5 ↓  
 3: 10,7\* ↖  
 4: 10,0 ↓  
 5: 10,4\* ↗  
 6: 9,1 ↓  
 7: 9,7 →  
 8: 10,8\* ↓  
 9: 10,1 ↓  
 10: 8,2 ↓

Serie 94,0

Totalt 0,0

Provskott

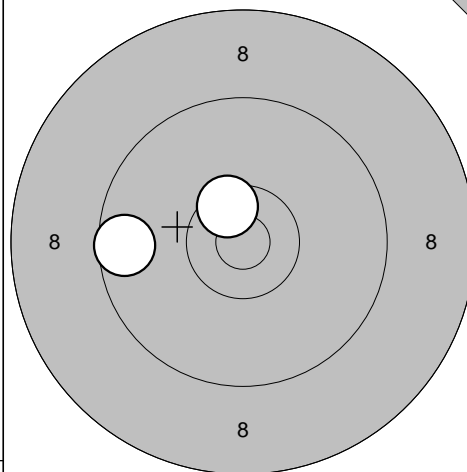

11: 9,6 ←  
 12: 10,5\* ↗

Serie 19,0

Totalt 0,0

Tävlingsskott

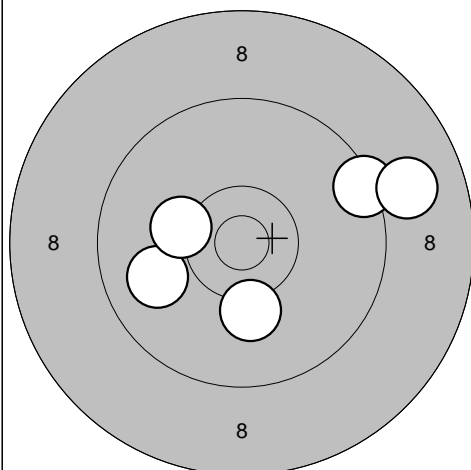

1: 9,9 ←  
 2: 9,4 →  
 3: 9,0 →  
 4: 10,2 ←  
 5: 10,2 ↓

Serie 47,0

Totalt 47,0

Tävlingsskott

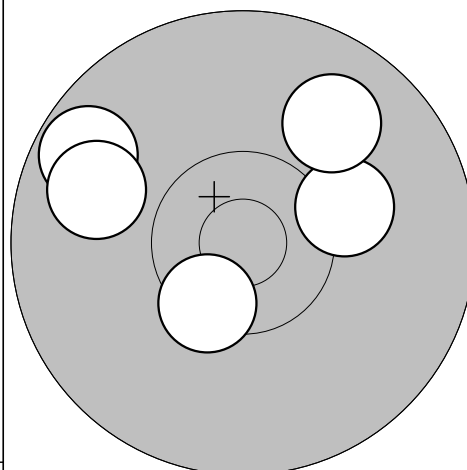

6: 10,2 →  
 7: 9,7 ↖  
 8: 10,4\* ↓  
 9: 9,9 ↗  
 10: 9,9 ←

Serie 47,0

Totalt 94,0

Tävlingsskott

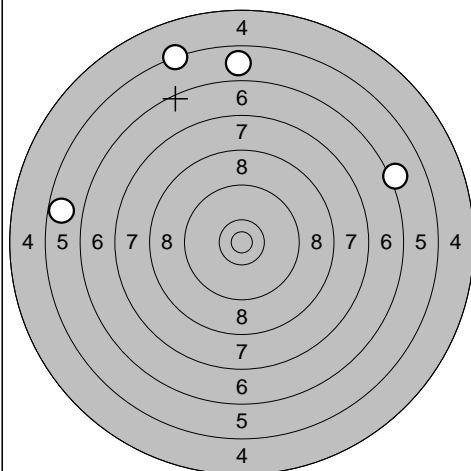

11: 5,8 ↑  
 12: 5,7 ←  
 13: 6,2 →  
 14: 5,3 ↗  
 15: 0,0 ↗

Serie 21,0

Totalt 115,0

Tävlingsskott

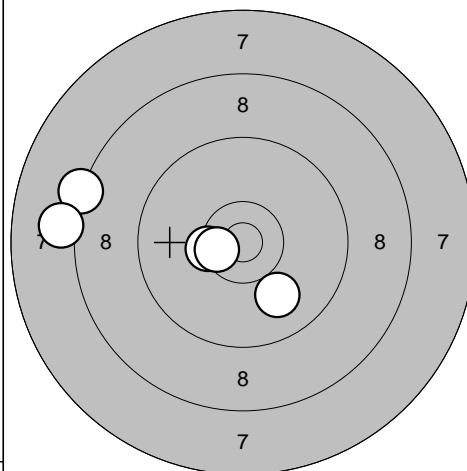

16: 10,0 ↓  
 17: 10,4\* ←  
 18: 8,3 ←  
 19: 8,1 ←  
 20: 10,5\* ←

Serie 46,0

Totalt 161,0

2009-07-16

Tavelträffen 2009

Ramselefors SKF

Provskott

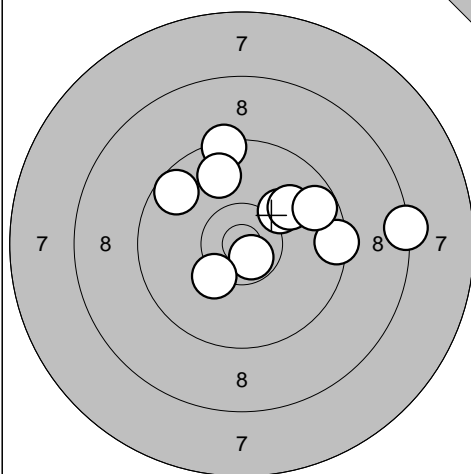

1: 9,4 ↗  
 2: 9,8 ↗  
 3: 8,4 →  
 4: 9,4 →  
 5: 10,2 ↗  
 6: 10,7\* ↘  
 7: 9,6 ↗  
 8: 10,3\* ↘  
 9: 10,0 ↗  
 10: 9,7 →

Serie 93,0

Totalt 0,0

Tävlingsskott

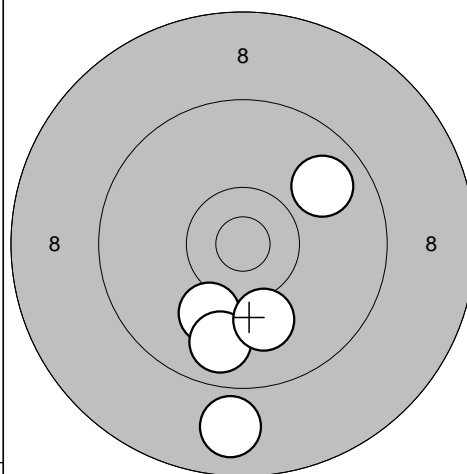

1: 8,9 ↓  
 2: 10,1 ↘  
 3: 9,8 ↓  
 4: 9,8 ↗  
 5: 10,1 ↓

Serie 46,0

Totalt 46,0

Tävlingsskott

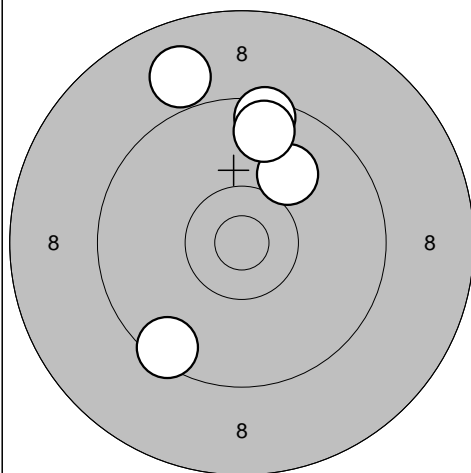

6: 10,0 ↗  
 7: 8,9 ↗  
 8: 9,5 ↘  
 9: 9,5 ↗  
 10: 9,7 ↗

Serie 45,0

Totalt 91,0

Tävlingsskott

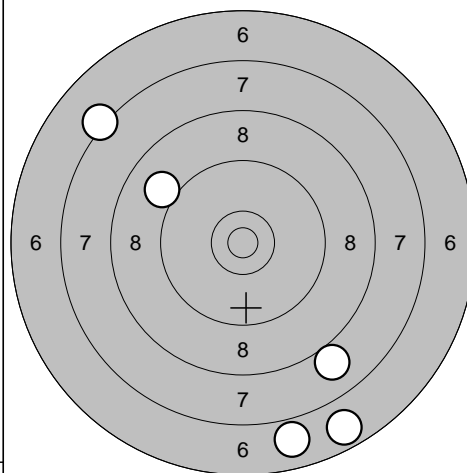

11: 8,0 ↓  
 12: 9,0 ↗  
 13: 6,7 ↓  
 14: 7,2 ↗  
 15: 6,9 ↓

Serie 36,0

Totalt 127,0

Tävlingsskott

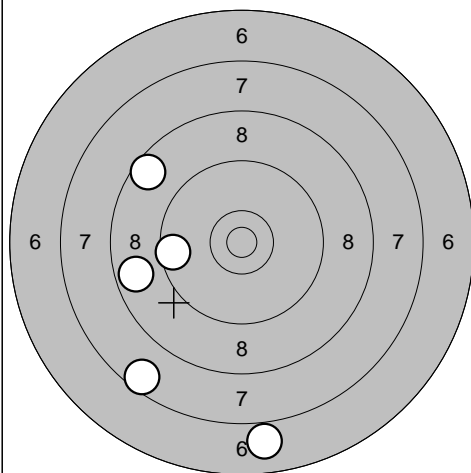

16: 6,9 ↓  
 17: 8,7 ←  
 18: 7,6 ↘  
 19: 8,6 ↗  
 20: 9,6 ←

Serie 38,0

Totalt 165,0

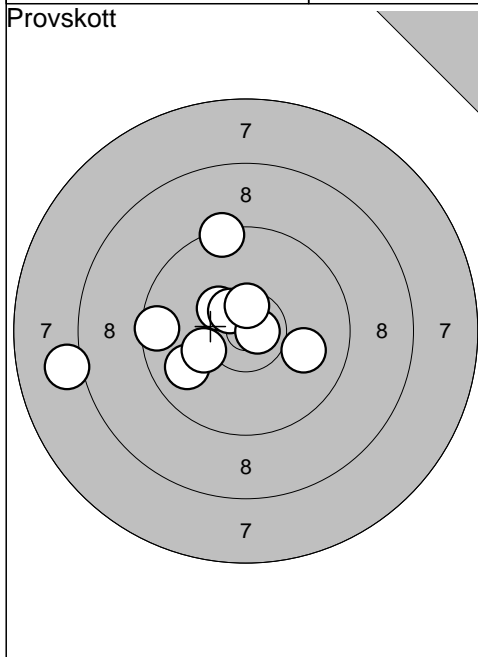

1: 8,1	←
2: 9,9	←
3: 10,0	→
4: 9,4	↑
5: 10,4*	↗
6: 10,6*	↗
7: 10,2	←
8: 10,8*	→
9: 9,6	←
10: 10,6*	↑
Serie 95,0	
Totalt 0,0	

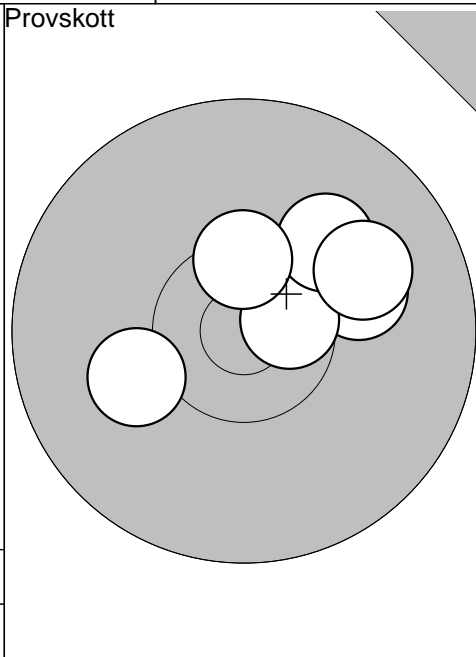

11: 10,1	→
12: 10,1	←
13: 10,6*	→
14: 10,1	↗
15: 10,4*	↑
16: 10,0	→
Serie 60,0	
Totalt 0,0	

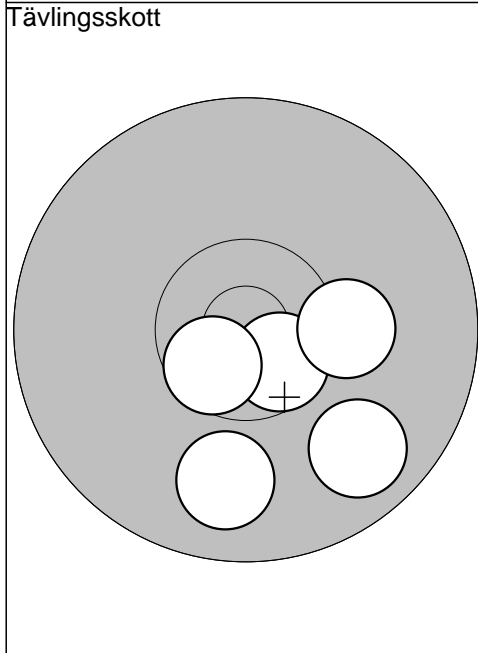

1: 9,9	↓
2: 10,6*	↓
3: 10,6*	↙
4: 9,8	↓
5: 10,2	→
Serie 48,0	
Totalt 48,0	

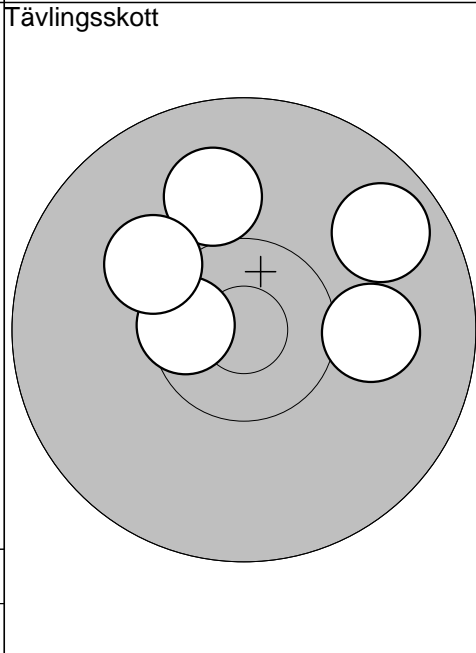

6: 9,8	↗
7: 10,0	→
8: 10,0	↑
9: 10,5*	←
10: 10,2	↖
Serie 49,0	
Totalt 97,0	

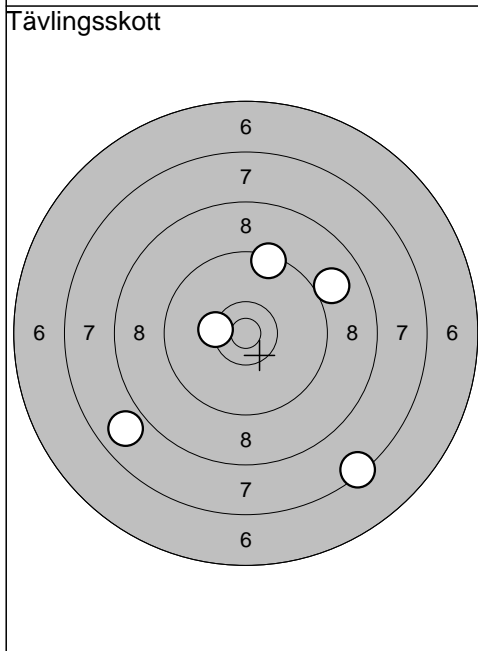

11: 7,9	↙
12: 10,3*	←
13: 7,4	↓
14: 9,0	↗
15: 9,4	↑
Serie 42,0	
Totalt 139,0	

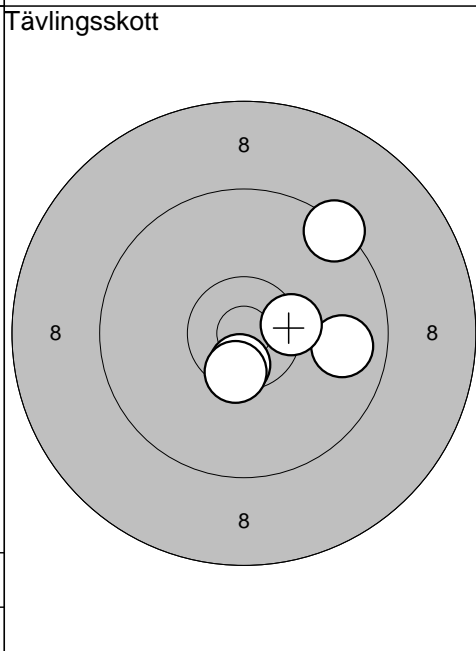

16: 9,8	→
17: 10,4*	→
18: 9,4	↗
19: 10,6*	↓
20: 10,5*	↓
Serie 48,0	
Totalt 187,0	

Ale

2009-07-16

Tavelträffen 2009

Ramselefors SKF

Provs-kott

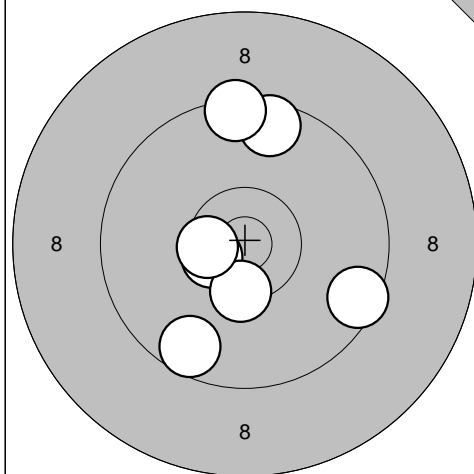

1: 9,6 ↗  
 2: 10,6\* ↖  
 3: 10,4\* ↓  
 4: 9,5 →  
 5: 9,6 ↓  
 6: 10,5\* ←  
 7: 9,4 ↑

Serie 66,0

Totalt 0,0

Tävlingsskott

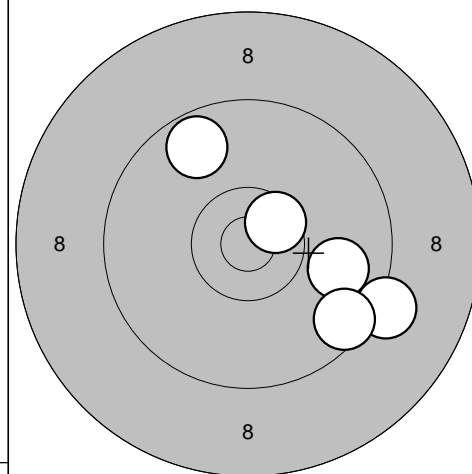

1: 10,6\* ↗  
 2: 9,9 →  
 3: 9,2 ↘  
 4: 9,5 ↘  
 5: 9,7 ↗

Serie 46,0

Totalt 46,0

Tävlingsskott

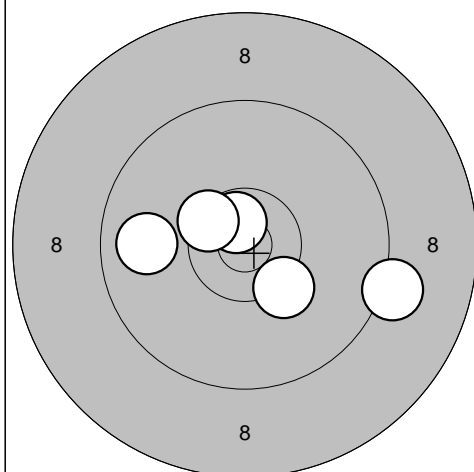

6: 9,2 →  
 7: 10,7\* ↗  
 8: 10,5\* ↗  
 9: 9,8 ←  
 10: 10,3\* ↓

Serie 48,0

Totalt 94,0

Tävlingsskott

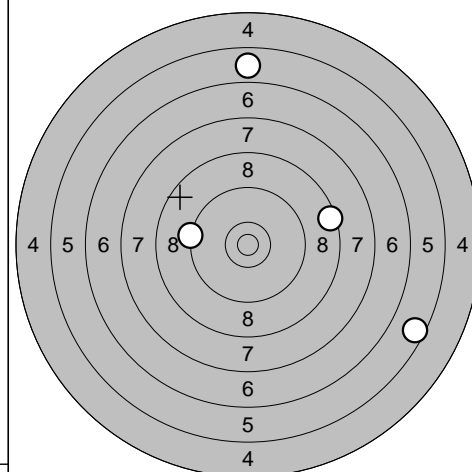

11: 0,0 ←  
 12: 8,5 →  
 13: 9,3 ←  
 14: 5,6 →  
 15: 5,8 ↑

Serie 27,0

Totalt 121,0

Tävlingsskott

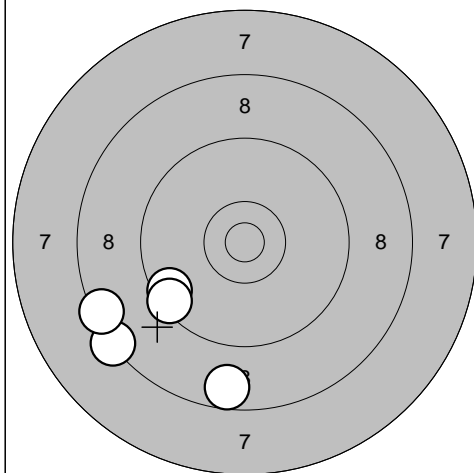

16: 8,6 ↓  
 17: 8,3 ↖  
 18: 8,5 ↖  
 19: 9,5 ↖  
 20: 9,4 ↖

Serie 42,0

Totalt 163,0

Norge

2009-07-16

Tavelträffen 2009

Ramselefors SKF

Provs-kott

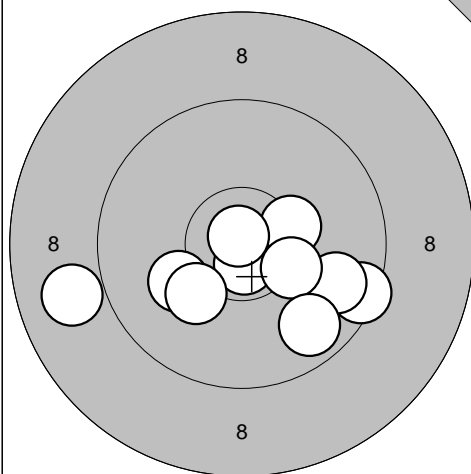

1: 9,5 ↘  
 2: 9,8 ↘  
 3: 10,1 ↙  
 4: 10,4\* →  
 5: 10,7\* ↓  
 6: 10,2 ↙  
 7: 10,3\* →  
 8: 10,9\* ↑  
 9: 8,9 ↙  
 10: 9,7 ↓

Serie 95,0

Totalt 0,0

Tävlingsskott

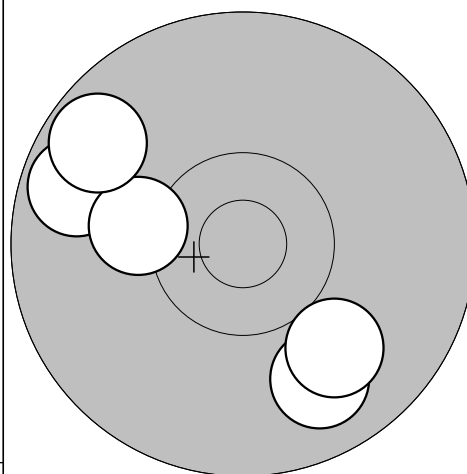

1: 9,7 ↙  
 2: 10,2 ↙  
 3: 9,8 ↓  
 4: 10,0 ↓  
 5: 9,7 ↗

Serie 47,0

Totalt 47,0

Tävlingsskott

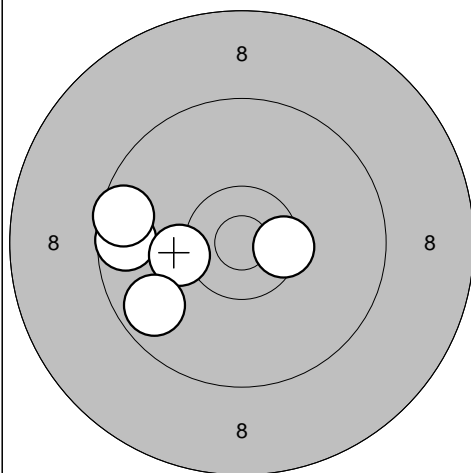

6: 10,5\* →  
 7: 9,6 ↙  
 8: 10,2 ↙  
 9: 9,6 ↙  
 10: 9,7 ↙

Serie 47,0

Totalt 94,0

Tävlingsskott

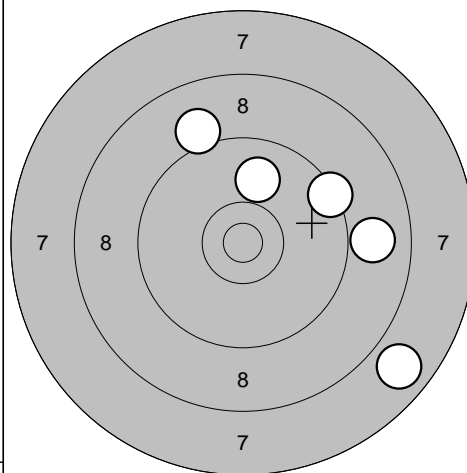

11: 9,1 ↗  
 12: 7,8 ↘  
 13: 9,9 ↑  
 14: 9,4 ↗  
 15: 8,9 →

Serie 42,0

Totalt 136,0

Tävlingsskott

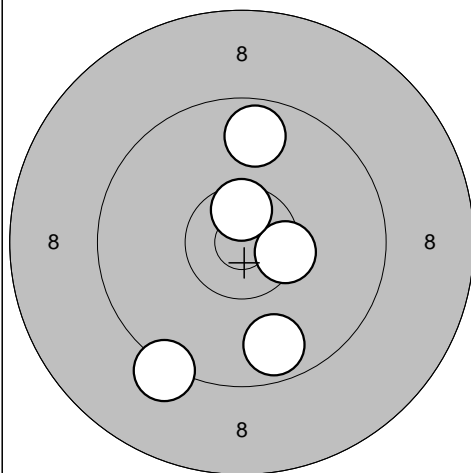

16: 9,7 ↑  
 17: 9,7 ↓  
 18: 10,4\* →  
 19: 9,2 ↓  
 20: 10,6\* ↑

Serie 47,0

Totalt 183,0

Piteå

2009-07-16

Tavelträffen 2009

Ramselefors SKF

Provskott

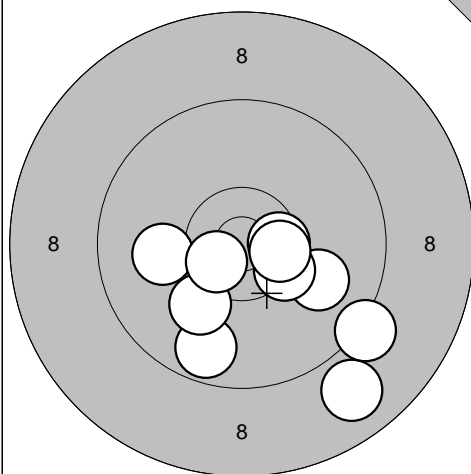

1: 10,0 ↘  
 2: 10,4\* ↘  
 3: 8,9 ↘  
 4: 10,5\* →  
 5: 10,0 ←  
 6: 9,2 ↘  
 7: 9,7 ↘  
 8: 10,1 ↘  
 9: 10,6\* ↙  
 10: 10,5\* →

Serie 96,0

Totalt 0,0

Provskott

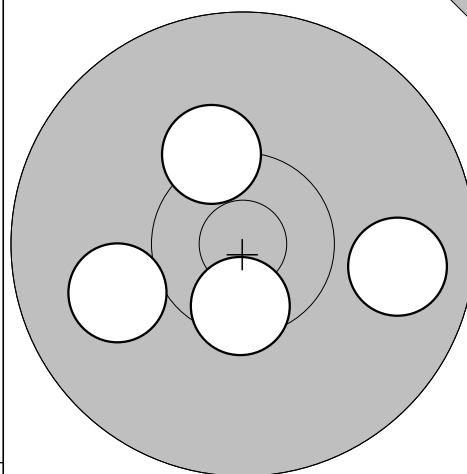

11: 10,0 ←  
 12: 10,5\* ↓  
 13: 9,8 →  
 14: 10,3 ↗

Serie 39,0

Totalt 0,0

Tävlingskott

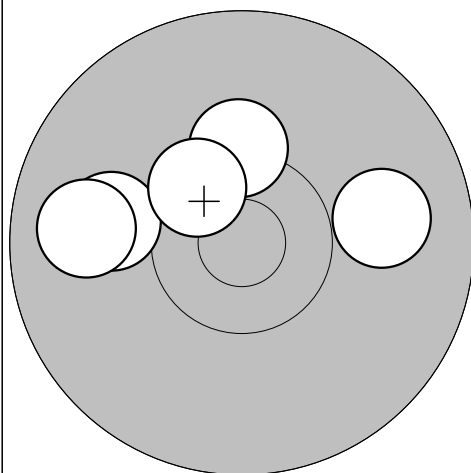

1: 10,3 ↑  
 2: 10,0 ←  
 3: 9,9 →  
 4: 9,8 ←  
 5: 10,4\* ↗

Serie 48,0

Totalt 48,0

Tävlingskott

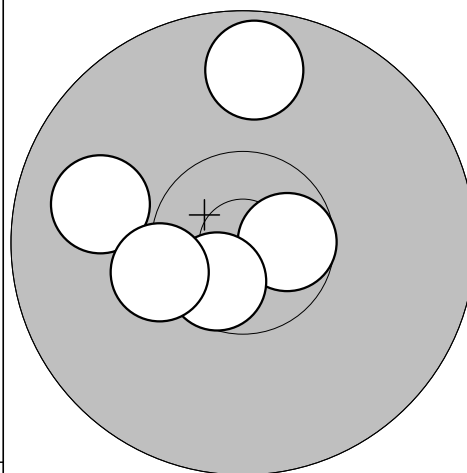

6: 10,6\* →  
 7: 9,7 ↑  
 8: 10,6\* ↘  
 9: 9,9 ←  
 10: 10,3\* ←

Serie 48,0

Totalt 96,0

Tävlingskott

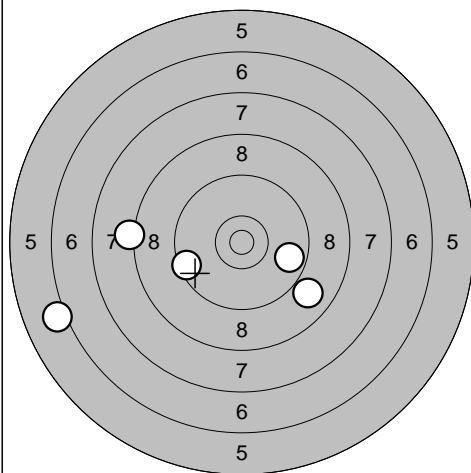

11: 9,5 ←  
 12: 6,1 ←  
 13: 8,9 ↘  
 14: 9,7 →  
 15: 8,2 ←

Serie 40,0

Totalt 136,0

Tävlingskott

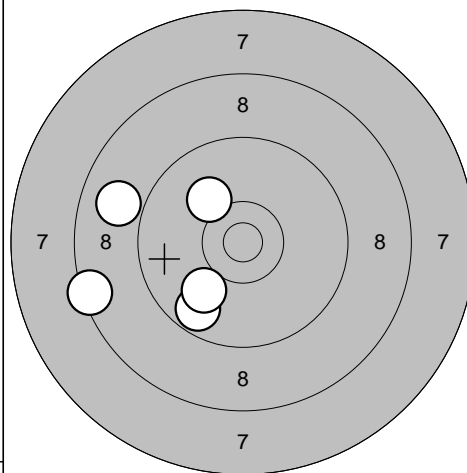

16: 8,9 ←  
 17: 8,4 ←  
 18: 9,7 ↘  
 19: 10,1 ↗  
 20: 10,0 ↘

Serie 45,0

Totalt 181,0



Piteå

2009-07-16

Tavelträffen 2009

Ramselefors SKF

Provskott

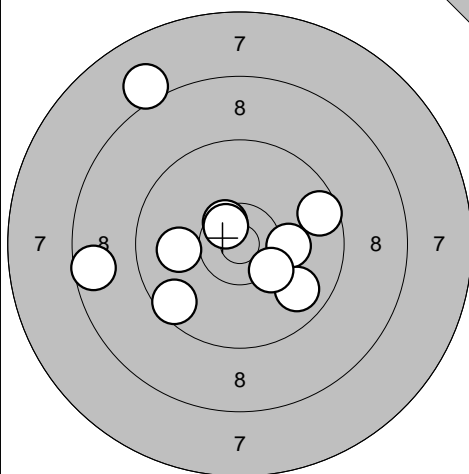

1: 9,6 →  
 2: 10,2 →  
 3: 9,8 ↘  
 4: 8,6 ←  
 5: 10,5\* ↗  
 6: 9,6 ↘  
 7: 10,0 ←  
 8: 8,1 ↗  
 9: 10,3\* ↘  
 10: 10,6\* ↗

Serie 93,0

Totalt 0,0

Provskott

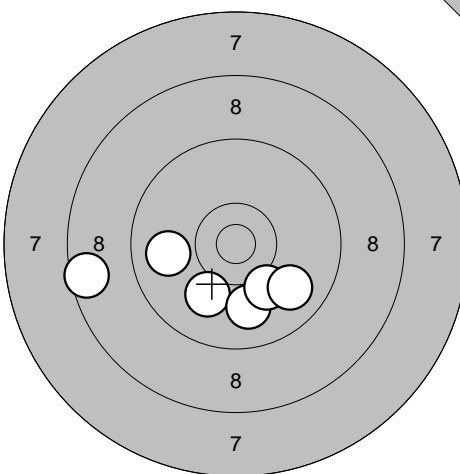

11: 9,9 ←  
 12: 10,0 ↘  
 13: 8,6 ←  
 14: 9,9 ↘  
 15: 10,1 ↘  
 16: 9,8 ↘

Serie 55,0

Totalt 0,0

Tävlingsskott

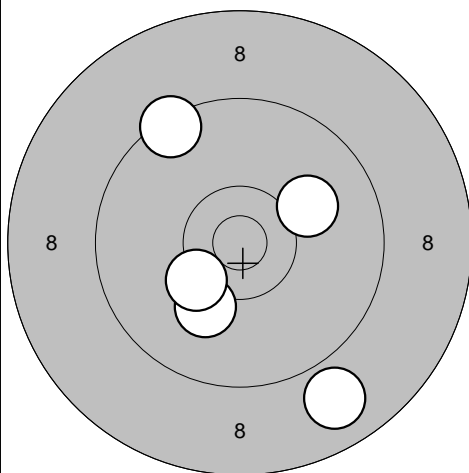

1: 9,4 ↗  
 2: 8,9 ↘  
 3: 10,1 ↘  
 4: 10,3\* ↘  
 5: 10,1 →

Serie 47,0

Totalt 47,0

Tävlingsskott

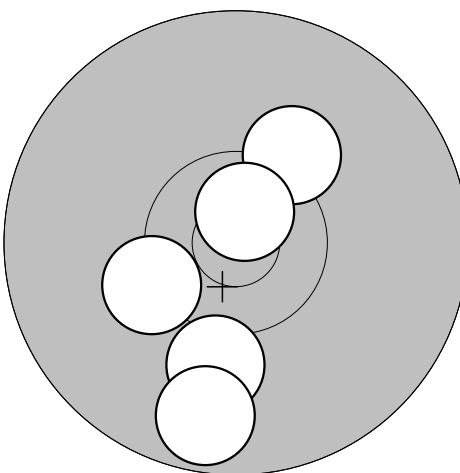

6: 10,3 ←  
 7: 10,2 ↗  
 8: 10,1 ↘  
 9: 10,7\* ↗

Serie 49,0

Totalt 96,0

Tävlingsskott

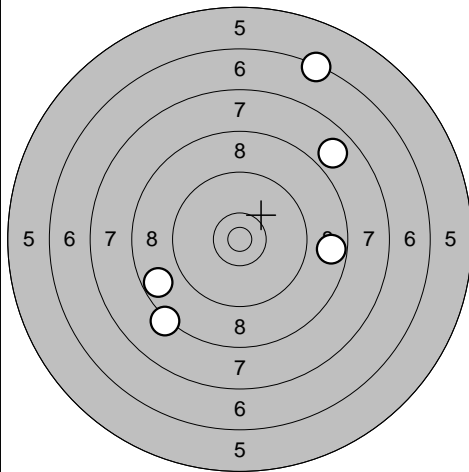

11: 8,7 ←  
 12: 8,3 ↘  
 13: 7,9 ↗  
 14: 6,4 ↗  
 15: 8,7 →

Serie 37,0

Totalt 133,0

Tävlingsskott

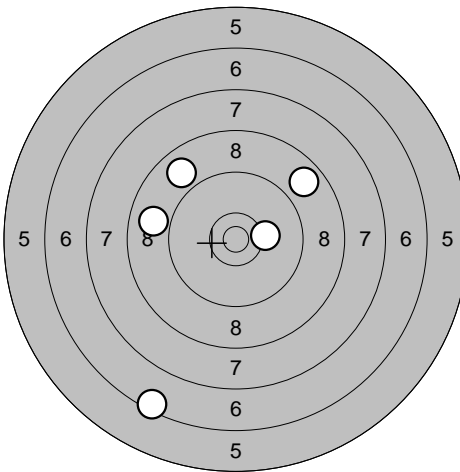

16: 8,8 ↗  
 17: 8,9 ←  
 18: 8,9 ↗  
 19: 6,5 ↘  
 20: 10,2 →

Serie 40,0

Totalt 173,0