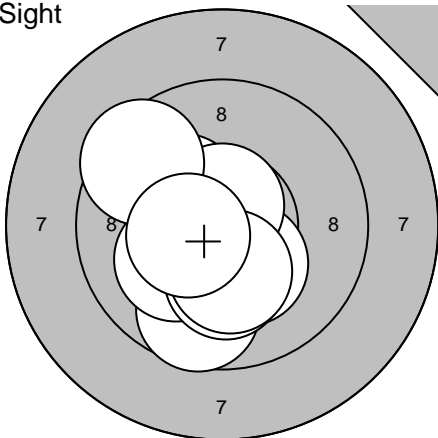
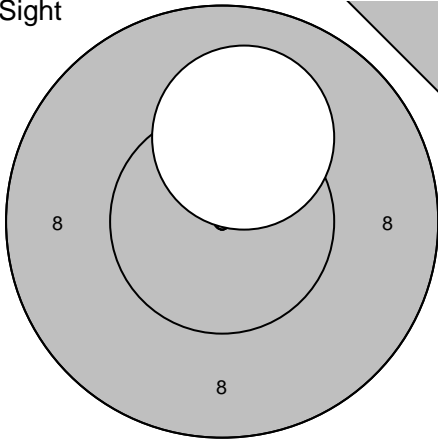
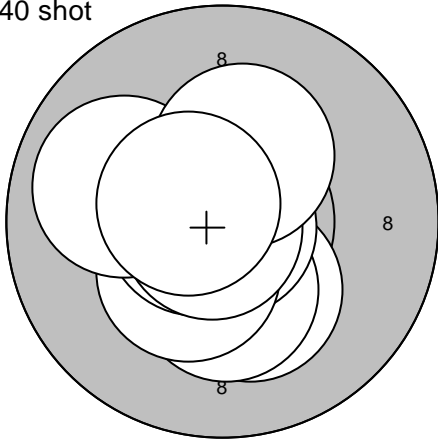
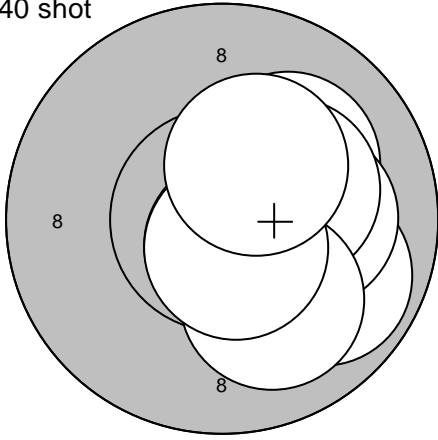
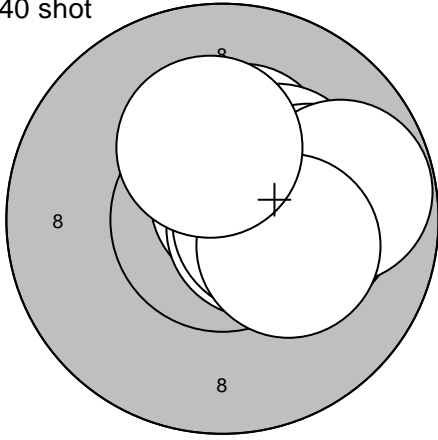
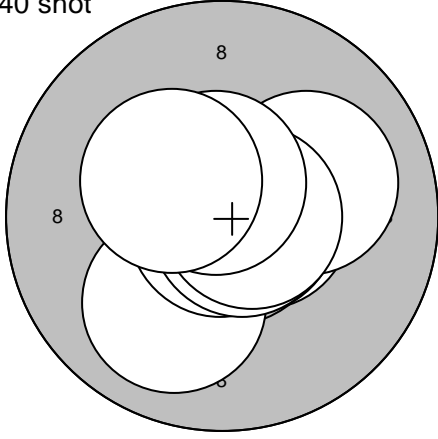
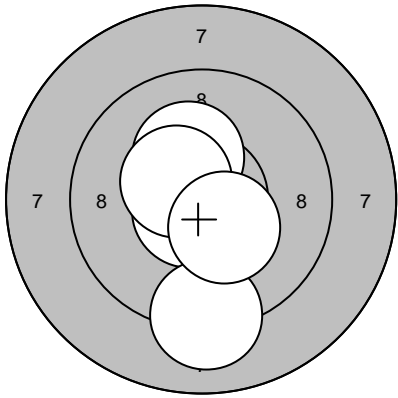
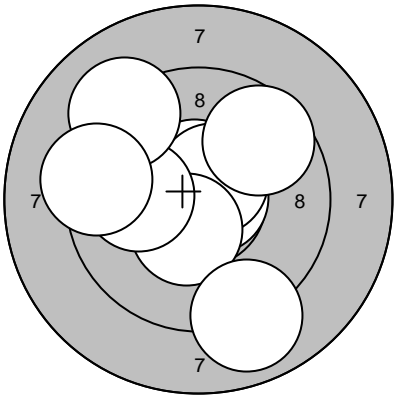
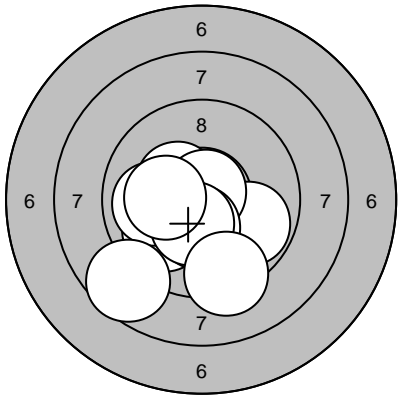
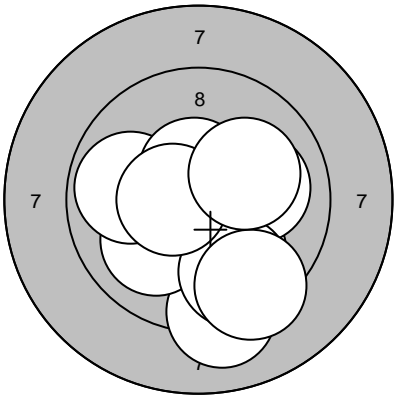
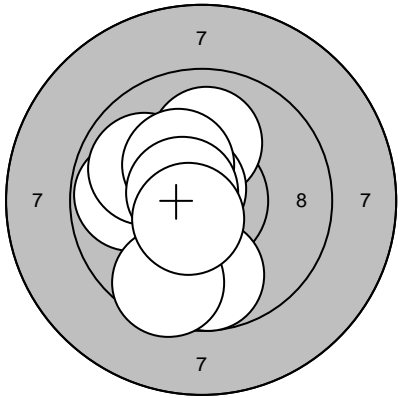
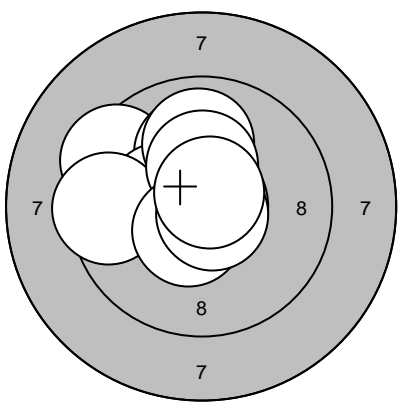
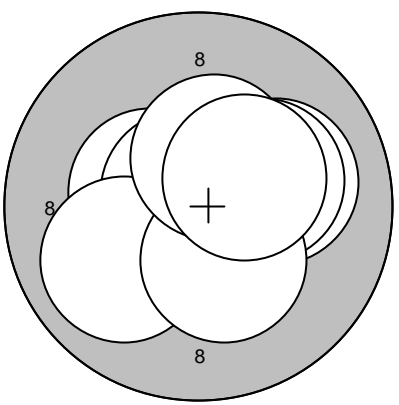
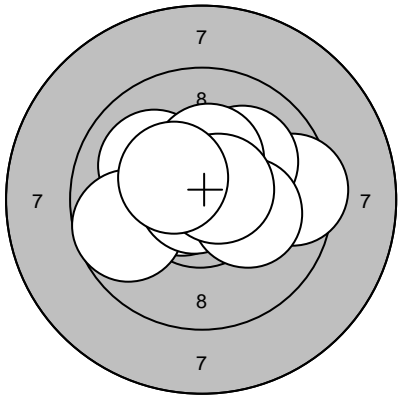
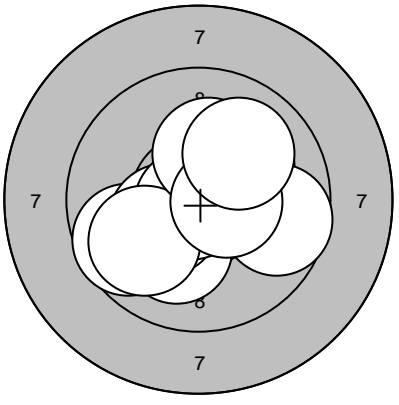
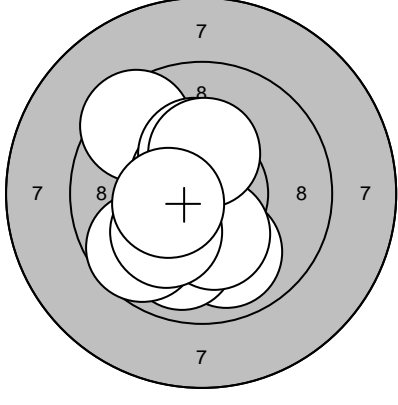

|            |   |  |  |
|------------|---|--|--|
| Skjutlag   | Tavla   |  |  |
| <b>1</b>   | <b>25</b>   | <b>Anton Lundin</b>  |  |
| STPL       | Umeå  |  |  |
| 2009-01-17 | Skyttiaden 2009   | Umeå skytteallians   |  |
| Sight      |    | 1: 10,3* ↖<br>2: 9,7 ↓<br>3: 10,3* ↓<br>4: 10,1 ↖<br>5: 10,7* ↖<br>6: 10,2* ↓<br>7: 10,7* ↖<br>8: 10,3* ↓<br>9: 9,5 ↗<br>10: 10,4* ←             | Sight  |
|            |   | Serie 98,0   | 11: 10,3* ←  |
|            |   | Totalt 0,0   | 12: 9,9 ↖  |
|            |   |  | 13: 10,0 ↗   |
|            |   |  | 14: 10,1 ↓   |
|            |   |  | 15: 10,1 ↓   |
|            |   |  | 16: 10,8* ↗  |
|            |   |  | 17: 10,3* ↖  |
|            |   |  | 18: 9,7 ↗  |
|            |   |  | 19: 10,7* ↑  |
|            |   |  | 20: 10,5* ↗  |
|            |   |  | Serie 98,0   |
|            |   |  | Totalt 0,0   |
| Sight      |   | 21: 10,1 ↑   | 40 shot  |
|            |   | Serie 10,0   |   |
|            |   | Totalt 0,0   | 1: 10,2* ↓   |
|            |   |  | 2: 10,3* ↓   |
|            |   |  | 3: 10,9* ↓   |
|            |   |  | 4: 10,4* ↓   |
|            |   |  | 5: 10,7* ←   |
|            |   |  | 6: 10,7* ↗   |
|            |   |  | 7: 10,8* ↖   |
|            |   |  | 8: 9,9 ←   |
|            |   |  | 9: 10,3* ↑   |
|            |   |  | 10: 10,6* ↖  |
|            |   |  | Serie 99,0   |
|            |   |  | Totalt 99,0  |
| 40 shot    |  | 11: 9,8 →<br>12: 10,4* ↗<br>13: 10,7* ↓<br>14: 10,5* →<br>15: 10,1 ↗<br>16: 10,1 →<br>17: 10,2* ↗<br>18: 10,0 ↓<br>19: 10,6* ↓<br>20: 10,3* ↗    | 40 shot  |
|            |   | Serie 99,0   |  |
|            |   | Totalt 198,0   | 21: 10,3* ↑  |
|            |   |  | 22: 10,7* ↗  |
|            |   |  | 23: 10,3* ↗  |
|            |   |  | 24: 10,6* →  |
|            |   |  | 25: 10,1 →   |
|            |   |  | 26: 10,5* →  |
|            |   |  | 27: 10,1 →   |
|            |   |  | 28: 9,8 →  |
|            |   |  | 29: 10,3* →  |
|            |   |  | 30: 10,2* ↑  |
|            |   |  | Serie 99,0   |
|            |   |  | Totalt 297,0   |
| 40 shot    |  | 31: 10,6* →<br>32: 10,9* ↓<br>33: 10,1 →<br>34: 10,7* →<br>35: 10,0 ↓<br>36: 10,8* ↓<br>37: 10,7* →<br>38: 10,7* →<br>39: 10,6* ↗<br>40: 10,4* ↗ |  |
|            |   | Serie 100,0  |  |
|            |   | Totalt 397,0   |  |

Umeå skf

|  |                    |  |                    |
|--|--------------------|--|--------------------|
| Skjutlag<br><b>1</b>   | Tavla<br><b>27</b> | <b>Daniel Paulsson</b>   |                    |
| STPL   |                    | Umeå   |                    |
| 2009-01-17   |                    | Skyttiaden 2009  | Umeå skytteallians |
| Sight<br>     | 1: 10,3* ↗         | 40 shot<br>  | 1: 10,0 ↖          |
|  | 2: 10,7* ↘         |  | 2: 10,6* ↑         |
|  | 3: 10,5* ↖         |  | 3: 10,7* →         |
|  | 4: 9,1 ↓           |  | 4: 10,6* ↗         |
|  | 5: 10,4* ↘         |  | 5: 10,4* ↘         |
|  | Serie 49,0         |  | Serie 96,0         |
|  | Totalt 0,0         |  | Totalt 96,0        |
| 40 shot<br>  | 11: 10,4* ↖        | 40 shot<br> | 21: 10,0 ↓         |
|  | 12: 9,9 ↖          |  | 22: 9,1 ↓          |
|  | 13: 10,0 ←         |  | 23: 10,0 ↘         |
|  | 14: 9,8 →          |  | 24: 9,9 ←          |
|  | 15: 10,8* ↗        |  | 25: 10,0 →         |
|  | 16: 10,3* ↓        |  | 26: 9,7 ↓          |
|  | 17: 10,4* ↓        |  | 27: 10,5* ↑        |
|  | 18: 8,7 ↖          |  | 28: 9,4 ↓          |
|  | 19: 9,3 ↓          |  | 29: 10,6* ←        |
|  | 20: 10,2* ←        |  | 30: 10,1 ↗         |
|  | Serie 95,0         |  | Serie 96,0         |
|  | Totalt 191,0       |  | Totalt 287,0       |
| 40 shot<br> | 31: 10,1 ↖         |  |                    |
|  | 32: 9,8 ↓          |  |                    |
|  | 33: 10,0 ↑         |  |                    |
|  | 34: 9,8 ←          |  |                    |
|  | 35: 9,9 ↗          |  |                    |
|  | 36: 9,5 ↓          |  |                    |
|  | 37: 10,7* ↗        |  |                    |
|  | 38: 10,3* ↗        |  |                    |
|  | 39: 10,6* ↖        |  |                    |
|  | 40: 10,6* ↘        |  |                    |
|  | Serie 96,0         |  |                    |
|  | Totalt 383,0       |  |                    |

Umeå skf

|   |  |   |   |
|---|--|---|---|
| Skjutlag  | Tavla  |   |   |
| <b>1</b>  | <b>29</b>  | <b>Edward Yu</b>  |   |
| STPL  | Umeå   |   |   |
| 2009-01-17  | Skyttiaden 2009  | Umeå skytteallians  |   |
| Sight   |  | 40 shot   |   |
|    | 1: 9,4 ↖<br>2: 10,1 ↑<br>3: 10,7* ↑<br>4: 10,3* ←<br>5: 9,5 ←<br>6: 10,0 ↑<br>7: 10,3* ↑<br>8: 10,5* ↓<br>9: 10,7* ↘<br>10: 10,7* ↗          |   | 1: 10,7* ←<br>2: 10,4* ←<br>3: 10,1 →<br>4: 10,7* ↗<br>5: 10,5* ↓<br>6: 10,2* →<br>7: 10,0 ←<br>8: 10,3* ↓<br>9: 10,4* ↑<br>10: 10,4* ↗   |
|   | Serie 98,0   |   | Serie 100,0   |
|   | Totalt 0,0   |   | Totalt 100,0  |
| 40 shot   |  | 40 shot   |   |
|   | 11: 9,5 →<br>12: 10,6* ←<br>13: 10,0 ↖<br>14: 9,7 ←<br>15: 10,1 ↗<br>16: 10,8* ←<br>17: 10,2* →<br>18: 10,3* ↑<br>19: 10,6* →<br>20: 10,4* ↖ |  | 21: 10,1 ↗<br>22: 9,7 →<br>23: 9,7 ←<br>24: 10,1 ↓<br>25: 10,3* ←<br>26: 10,8* ←<br>27: 9,9 ←<br>28: 10,2* ↑<br>29: 10,5* →<br>30: 10,0 ↗ |
|   | Serie 98,0   |   | Serie 97,0  |
|   | Totalt 198,0   |   | Totalt 295,0  |
| 40 shot   |  |   |   |
|  | 31: 9,5 ↖<br>32: 9,9 ↓<br>33: 9,9 ↓<br>34: 10,6* ↖<br>35: 10,3* ↑<br>36: 9,7 ←<br>37: 10,2* ↓<br>38: 10,1 ←<br>39: 10,3* ↑<br>40: 10,4* ←    |   |   |
|   | Serie 96,0   |   |   |
|   | Totalt 391,0   |   |   |
| <b>Umeå skf</b>   |  |   |   |

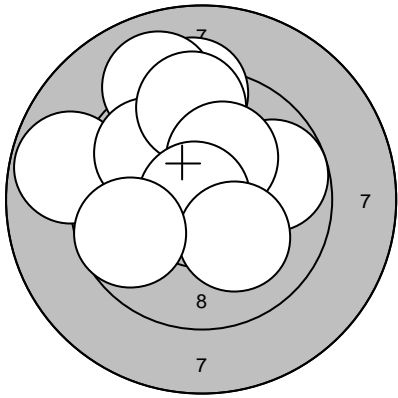
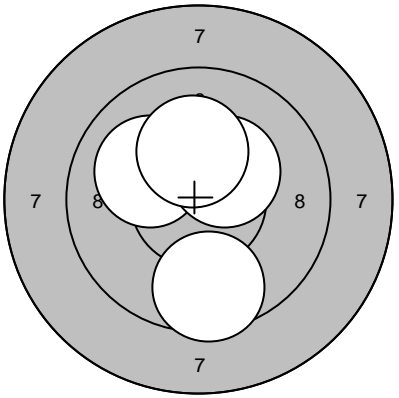
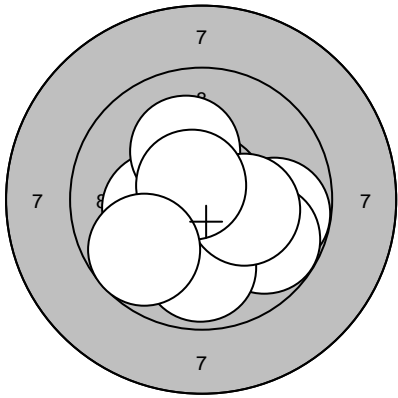
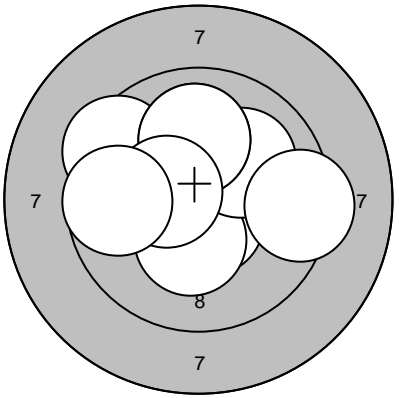
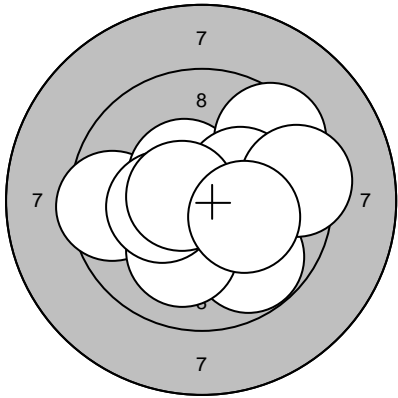
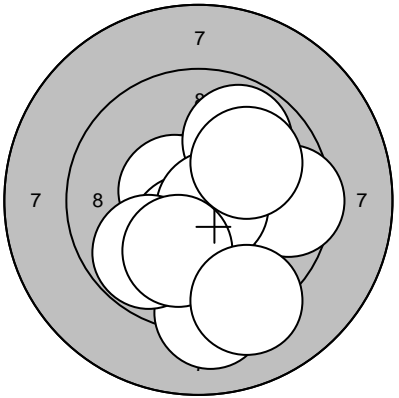
| Skjutlag   | Tavla   | Emmi Ruzin  |   |
|------------|---|---|---|
| 1          | 31  |   |   |
| STPL       | Umeå  |   |   |
| 2009-01-17 | Skyttiaden 2009   | Umeå skytteallians  |   |
| Sight      |    | 1: 9,3 ↑<br>2: 8,8 ←<br>3: 9,8 →<br>4: 9,0 ↑<br>5: 9,8 ↗<br>6: 9,5 ↑<br>7: 10,2* ↗<br>8: 10,8* ←<br>9: 10,2* ↘<br>10: 9,7 ←<br>Serie 92,0<br>Totalt 0,0                 | Sight   |
|            |   |   | 11: 10,1 ↖<br>12: 10,3* ↗<br>13: 9,6 ↓<br>14: 10,2* ↑<br>Serie 39,0<br>Totalt 0,0   |
| 40 shot    |   | 1: 10,0 ↓<br>2: 9,8 →<br>3: 9,8 ↘<br>4: 10,5* ↓<br>5: 9,9 ↓<br>6: 10,3* ←<br>7: 10,2* ↑<br>8: 10,2* →<br>9: 10,7* ↗<br>10: 9,7 ↙<br>Serie 96,0<br>Totalt 96,0           | 40 shot    |
|            |   |   | 11: 10,6* ↑<br>12: 10,6* ↓<br>13: 9,5 ↖<br>14: 10,3* ↓<br>15: 10,1 ↗<br>16: 10,0 ↑<br>17: 10,0 ↑<br>18: 9,3 →<br>19: 10,4* ←<br>20: 9,7 ←<br>Serie 97,0<br>Totalt 193,0 |
| 40 shot    |  | 21: 9,5 ←<br>22: 10,5* ↗<br>23: 9,8 ↘<br>24: 10,1 ↓<br>25: 10,3* ←<br>26: 9,5 ↗<br>27: 10,3* →<br>28: 10,6* ←<br>29: 9,4 →<br>30: 10,2* ↘<br>Serie 96,0<br>Totalt 289,0 | 40 shot   |
|            |   |   | 31: 9,2 ↓<br>32: 10,5* ↖<br>33: 9,8 ↗<br>34: 9,5 →<br>35: 10,4* ↓<br>36: 10,7* ↘<br>37: 9,8 ↙<br>38: 10,0 ↗<br>39: 10,1 ↓<br>40: 9,2 ↓<br>Serie 95,0<br>Totalt 384,0    |
| Umeå skf   |   |   |   |

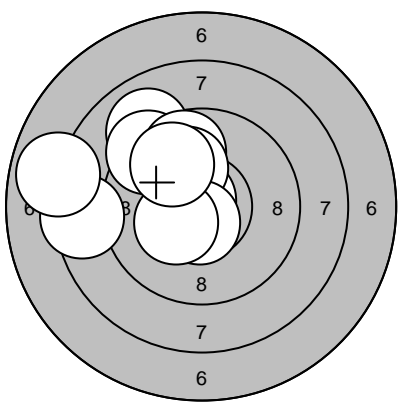
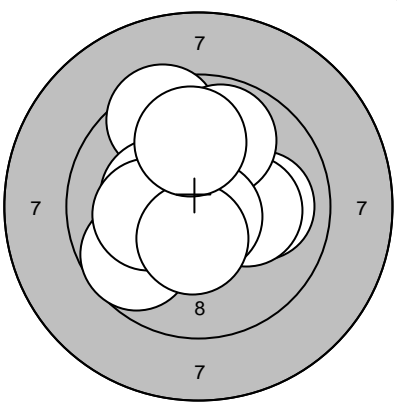
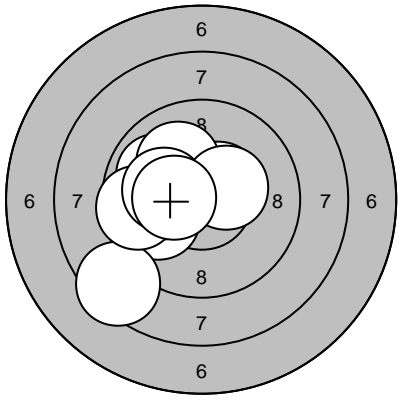
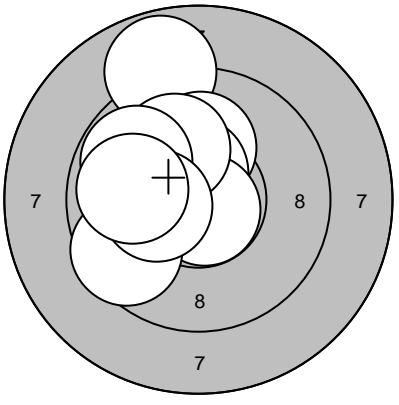
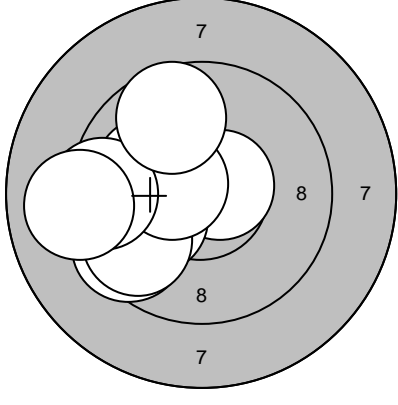
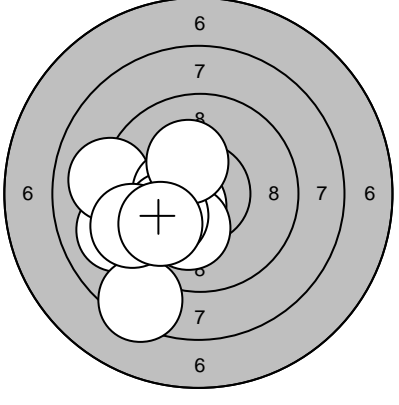
| Skjutlag   | Tavla   | Fredrik Öhgren   |  |
|------------|---|--|--|
| 1          | 33  |  |  |
| STPL       | Umeå  |  |  |
| 2009-01-17 | Skyttiaden 2009   | Umeå skytteallians   |  |
| Sight      |    | 1: 9,0 ↗<br>2: 9,4 ↗<br>3: 8,4 ←<br>4: 10,8* ↗<br>5: 9,8 ↗<br>6: 10,1 ↗<br>7: 7,9 ←<br>8: 10,6* ↓<br>9: 10,3* ↙<br>10: 9,9 ↗<br>Serie 91,0<br>Totalt 0,0             | Sight    |
|            |   |  | 11: 10,0 →<br>12: 9,5 ↗<br>13: 10,2* →<br>14: 9,8 ↗<br>15: 10,7* ↓<br>16: 9,7 ↙<br>17: 10,3* ←<br>18: 10,2* ←<br>19: 10,4* ↓<br>20: 9,9 ↑<br>Serie 96,0<br>Totalt 0,0  |
| 40 shot    |   | 1: 10,0 ←<br>2: 10,5* ↗<br>3: 9,9 ↙<br>4: 8,5 ↙<br>5: 10,1 ←<br>6: 9,6 ←<br>7: 10,1 ↗<br>8: 10,2* ←<br>9: 10,4* →<br>10: 10,4* ←<br>Serie 96,0<br>Totalt 96,0        | 40 shot   |
|            |   |  | 11: 10,7* ↙<br>12: 8,9 ↗<br>13: 10,1 ↑<br>14: 10,5* ↑<br>15: 10,7* ↓<br>16: 10,1 ↗<br>17: 9,8 ↙<br>18: 9,5 ↙<br>19: 10,3* ←<br>20: 9,9 ←<br>Serie 95,0<br>Totalt 191,0 |
| 40 shot    |  | 21: 10,6* →<br>22: 9,5 ↙<br>23: 10,1 ←<br>24: 10,1 ↙<br>25: 10,4* ←<br>26: 9,7 ↙<br>27: 10,5* ↙<br>28: 9,4 ←<br>29: 9,7 ↗<br>30: 9,0 ←<br>Serie 95,0<br>Totalt 286,0 | 40 shot    |
|            |   |  | 31: 9,1 ↙<br>32: 9,1 ←<br>33: 10,4* ←<br>34: 10,6* ↙<br>35: 8,4 ↓<br>36: 10,2* ↓<br>37: 10,1 ↙<br>38: 10,3* ↗<br>39: 9,4 ↙<br>40: 9,9 ↙<br>Serie 94,0<br>Totalt 380,0  |
| Umeå skf   |   |  |  |

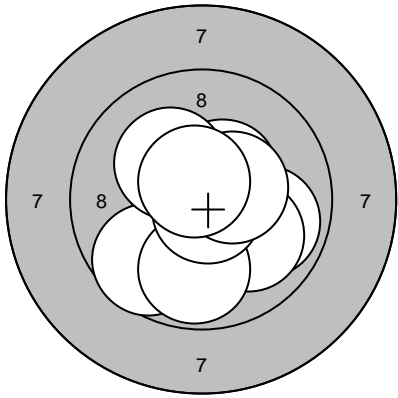
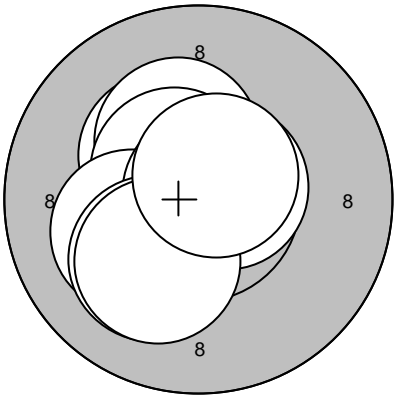
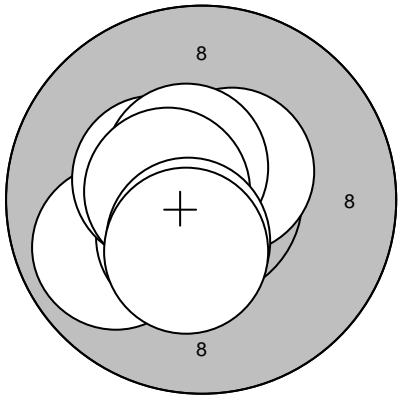
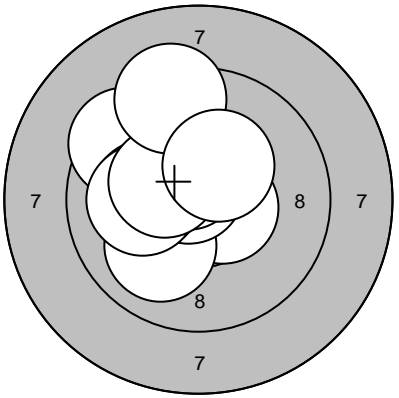
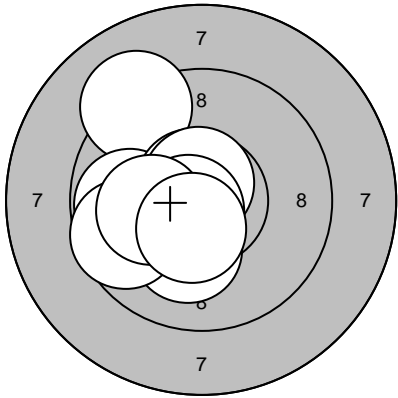
|   |  |   |   |
|---|--|---|---|
| Skjutlag  | Tavla  | <b>Joel Lundqvist</b>   |   |
| <b>1</b>  | <b>35</b>  |   |   |
| STPL  | Umeå   |   |   |
| 2009-01-17  | Skyttiaden 2009  | Umeå skytteallians  |   |
| Sight   |  | 40 shot   |   |
|    | 1: 10,7* ↖<br>2: 10,4* ↗<br>3: 9,9 →<br>4: 10,0 ↘<br>5: 9,7 ↓<br>6: 9,8 ↓<br>7: 10,8* ↓<br>8: 10,4* →<br>9: 10,2* ↗<br>10: 10,7* ↗               |   | 1: 10,3* ↖<br>2: 10,3* ↗<br>3: 10,6* ←<br>4: 10,6* ↖<br>5: 10,2* ←<br>6: 10,8* ↗<br>7: 10,1 ↓<br>8: 10,6* →<br>9: 10,2* ↓<br>10: 10,6* ↗    |
|   | Serie 97,0   |   | Serie 100,0   |
|   | Totalt 0,0   |   | Totalt 100,0  |
| 40 shot   |  | 40 shot   |   |
|   | 11: 10,8* ↖<br>12: 9,9 ←<br>13: 10,5* ↓<br>14: 10,4* ↖<br>15: 10,8* ↘<br>16: 10,5* ↗<br>17: 10,6* ↗<br>18: 10,6* ←<br>19: 10,5* ↓<br>20: 10,4* ↓ |  | 21: 10,6* →<br>22: 10,0 ↓<br>23: 10,7* ↗<br>24: 10,5* ↗<br>25: 9,5 ↖<br>26: 10,1 ←<br>27: 10,1 ←<br>28: 10,4* ↖<br>29: 9,3 ↗<br>30: 10,3* ↗ |
|   | Serie 99,0   |   | Serie 98,0  |
|   | Totalt 199,0   |   | Totalt 297,0  |
| 40 shot   |  |   |   |
|  | 31: 9,2 ↖<br>32: 10,6* ↓<br>33: 9,8 ←<br>34: 10,7* ↗<br>35: 10,7* ↗<br>36: 10,7* ↘<br>37: 10,2* ↓<br>38: 9,6 ←<br>39: 10,1 ←<br>40: 10,5* ↓      |   |   |
|   | Serie 97,0   |   |   |
|   | Totalt 394,0   |   |   |
| <b>Umeå skf</b>   |  |   |   |

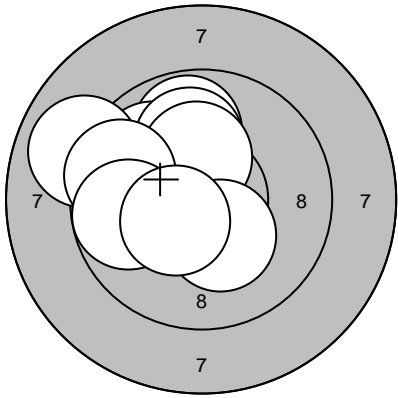
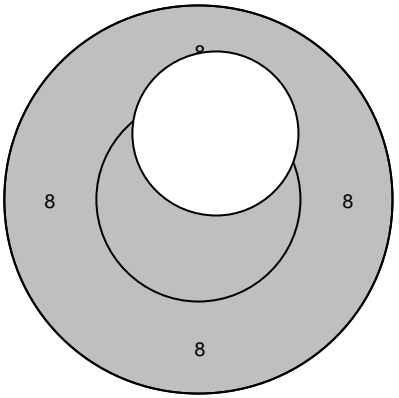
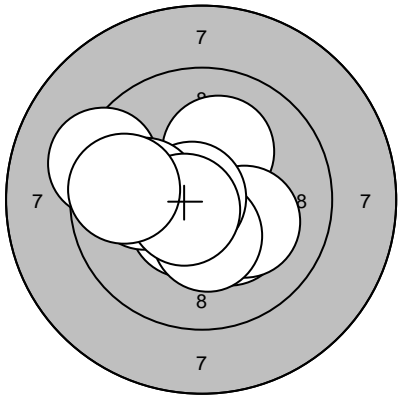
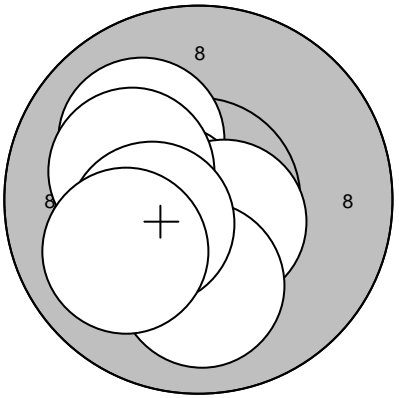
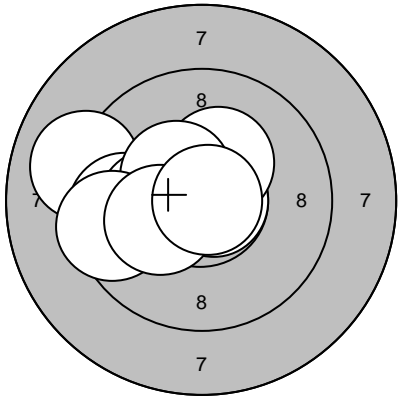
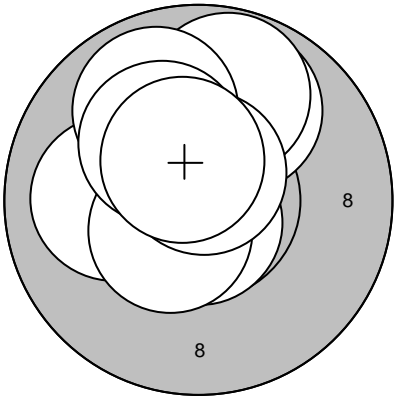
| Skjutlag   | Tavla   |  |   |
|------------|---|--|---|
| 1          | 37  | Melker Henriksson  |   |
| STPL       | Umeå  |  |   |
| 2009-01-17 | Skyttiaden 2009   | Umeå skytteallians   |   |
| Sight      |    | 1: 9,9 ↑<br>2: 9,9 ↗<br>3: 9,0 ↖<br>4: 9,9 ←<br>5: 10,0 ↑<br>6: 10,3* ↑<br>7: 9,6 ↖<br>8: 9,8 ←<br>9: 10,3* ↓<br>10: 10,4* ↙<br>Serie 94,0<br>Totalt 0,0                   | Sight<br>     |
|            |   |  | 11: 10,2* ↑   |
|            |   |  | Serie 10,0  |
|            |   |  | Totalt 0,0  |
| 40 shot    |   | 1: 10,5* ↙<br>2: 10,1 ↑<br>3: 10,3* ↘<br>4: 10,2* →<br>5: 9,3 ↖<br>6: 10,4* ↓<br>7: 10,8* ←<br>8: 10,0 ←<br>9: 10,6* ↙<br>10: 9,7 ←<br>Serie 98,0<br>Totalt 98,0           | 40 shot<br>  |
|            |   |  | 11: 10,2* ↖   |
|            |   |  | 12: 10,1 ↗  |
|            |   |  | 13: 10,6* ←   |
|            |   |  | 14: 10,1 ↖  |
|            |   |  | 15: 10,6* ↘   |
|            |   |  | 16: 10,6* ↘   |
|            |   |  | 17: 10,2* ↖   |
|            |   |  | 18: 10,0 ↓  |
|            |   |  | 19: 10,4* ↖   |
|            |   |  | 20: 10,0 ↙  |
|            |   |  | Serie 100,0   |
|            |   |  | Totalt 198,0  |
| 40 shot    |  | 21: 10,8* →<br>22: 9,0 ↖<br>23: 10,4* ↑<br>24: 9,7 ←<br>25: 10,3* ↑<br>26: 10,2* ←<br>27: 10,4* ↗<br>28: 9,5 ←<br>29: 10,2* ↖<br>30: 10,8* →<br>Serie 97,0<br>Totalt 295,0 | 40 shot<br> |
|            |   |  | 31: 9,9 ↗   |
|            |   |  | 32: 10,6* ↗   |
|            |   |  | 33: 10,0 ←  |
|            |   |  | 34: 9,8 ↑   |
|            |   |  | 35: 10,7* ↓   |
|            |   |  | 36: 10,5* ↙   |
|            |   |  | 37: 10,7* ↑   |
|            |   |  | 38: 9,9 ↗   |
|            |   |  | 39: 10,2* ↗   |
|            |   |  | 40: 10,5* ↗   |
|            |   |  | Serie 97,0  |
|            |   |  | Totalt 392,0  |
| Umeå skf   |   |  |   |

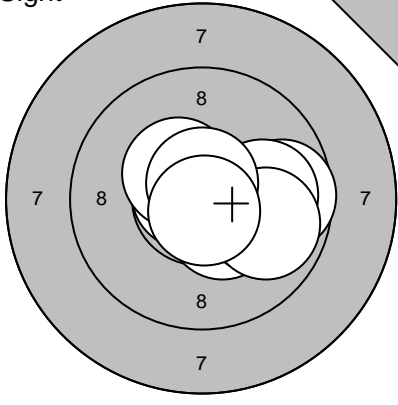
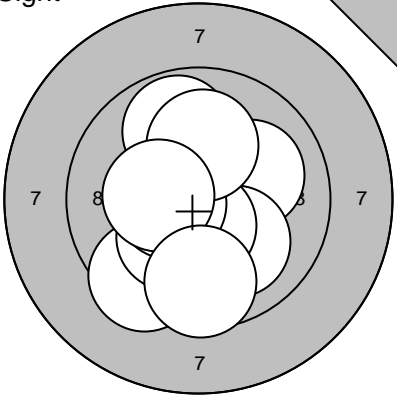
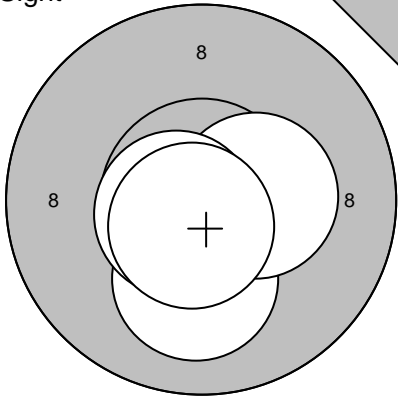
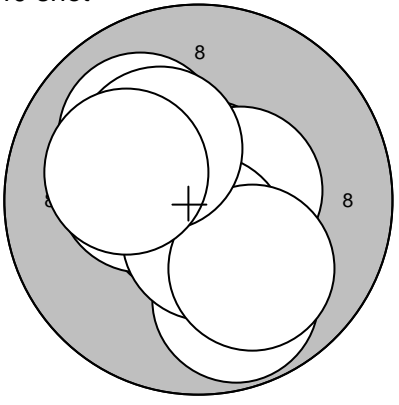
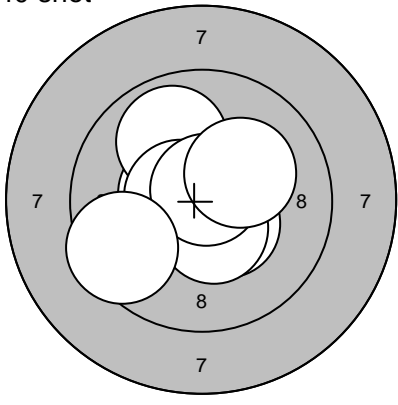
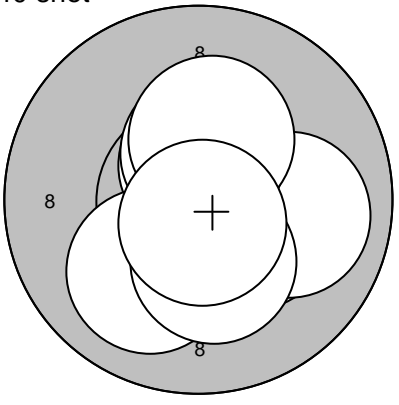
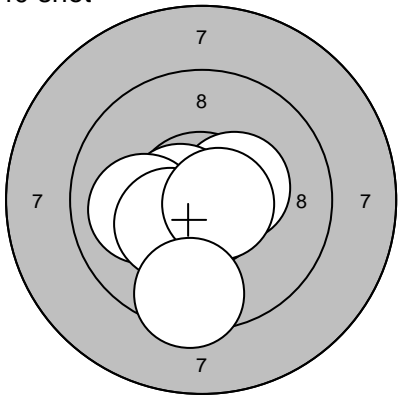
| Skjutlag   | Tavla   | William Öster   |  |   |
|------------|---|---|--|---|
| 1          | 39  |   |  |   |
| STPL       | Umeå  |   |  |   |
| 2009-01-17 | Skyttiaden 2009   | Umeå skytteallians  |  |   |
| Sight      |    | 1: 10,4* ↘<br>2: 10,2* →<br>3: 9,7 →<br>4: 10,0 →<br>5: 10,8* ↖<br>6: 10,0 →<br>7: 9,8 →<br>8: 10,4* ↗<br>9: 10,7* ↑<br>10: 10,7* ↓<br>Serie 98,0<br>Totalt 0,0               | Sight      | 11: 9,5 ↙<br>12: 10,2* ↙<br>13: 10,1 →<br>14: 10,1 ↘<br>15: 10,5* ↓<br>16: 9,8 ↗<br>17: 10,5* ←<br>18: 10,1 ↑<br>19: 10,3* ←<br>20: 9,6 ↓<br>Serie 97,0<br>Totalt 0,0           |
| Sight      |   | 21: 10,1 ↓<br>22: 10,4* →<br>23: 10,6* ←<br>24: 10,6* ↓<br>Serie 40,0<br>Totalt 0,0   | 40 shot   | 1: 9,8 ↓<br>2: 10,6* ↓<br>3: 10,3* ↖<br>4: 10,5* →<br>5: 10,4* ↗<br>6: 10,5* ↓<br>7: 10,0 ↘<br>8: 10,0 ↗<br>9: 10,3* ↗<br>10: 10,1 ↖<br>Serie 99,0<br>Totalt 99,0               |
| 40 shot    |  | 11: 10,4* ↘<br>12: 10,5* ←<br>13: 9,9 ↗<br>14: 10,7* →<br>15: 10,6* ←<br>16: 10,6* ←<br>17: 10,5* ↓<br>18: 10,8* ↗<br>19: 10,2* ↗<br>20: 9,5 ↙<br>Serie 98,0<br>Totalt 197,0  | 40 shot  | 21: 10,8* ↘<br>22: 10,6* ↑<br>23: 10,3* ↘<br>24: 10,3* ↓<br>25: 10,0 →<br>26: 10,0 ↙<br>27: 10,4* ↑<br>28: 10,3* ↓<br>29: 10,3* ↑<br>30: 10,7* ↓<br>Serie 100,0<br>Totalt 297,0 |
| 40 shot    |  | 31: 10,5* ↙<br>32: 10,6* ↙<br>33: 10,4* →<br>34: 10,8* ↓<br>35: 10,6* ←<br>36: 10,4* ↓<br>37: 10,0 ←<br>38: 10,3* ↙<br>39: 10,7* →<br>40: 9,5 ↓<br>Serie 99,0<br>Totalt 396,0 |  |   |
| Umeå skf   |   |   |  |   |

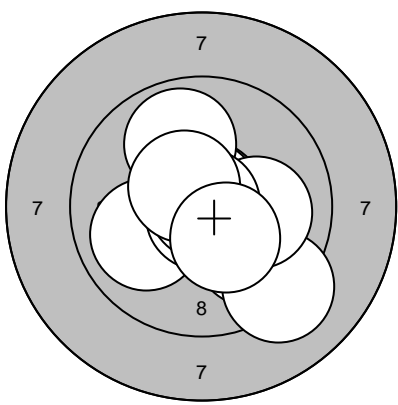
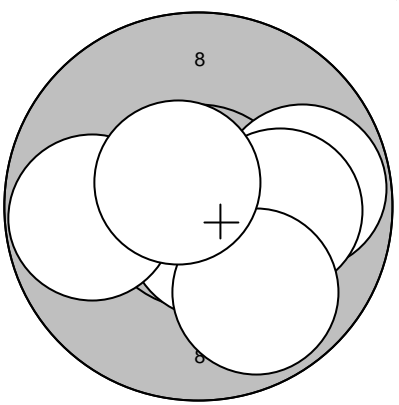
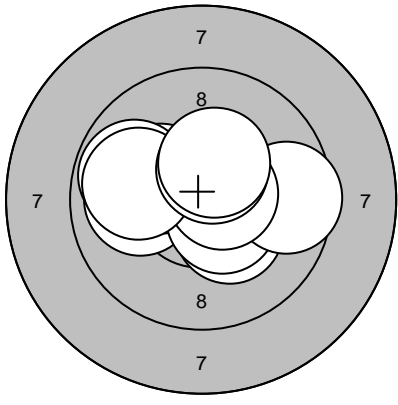
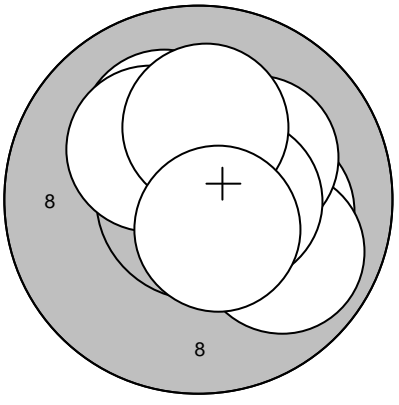
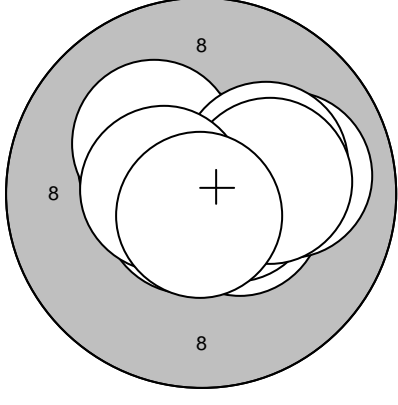
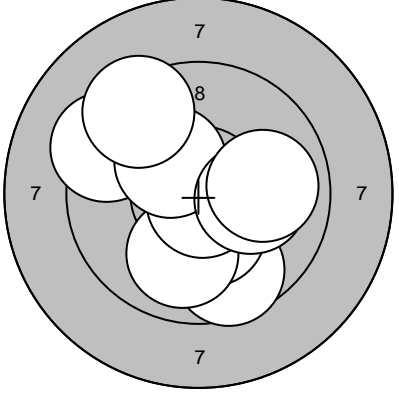

| Skjutlag   | Tavla   | Hanna Strömberg  |  |
|------------|---|--|--|
| 2          | 1   |  |  |
| STPL       | Ramselefors   |  |  |
| 2009-01-17 | Skyttiaden 2009   | Umeå skytteallians   |  |
| Sight      |    | 1: 9,9 ↘<br>2: 10,0 ←<br>3: 9,2 ↘<br>4: 10,8* ↘<br>5: 10,8* ↗<br>6: 10,1 →<br>7: 9,9 ↗<br>8: 10,9* →<br>9: 10,5* ↗<br>10: 10,3* ↘<br>Serie 97,0<br>Totalt 0,0                    | Sight    |
|            |   |  | 11: 10,6* ↘<br>12: 9,8 →<br>13: 10,1 →<br>14: 9,8 ↘<br>15: 9,8 ←<br>16: 10,6* ↗<br>Serie 57,0<br>Totalt 0,0  |
| 40 shot    |   | 1: 10,3* ↘<br>2: 10,0 ←<br>3: 10,2* ↗<br>4: 9,8 ↗<br>5: 10,5* ↘<br>6: 9,6 →<br>7: 10,6* →<br>8: 9,9 ←<br>9: 10,4* ↗<br>10: 10,3* ↗<br>Serie 97,0<br>Totalt 97,0                  | 40 shot   |
|            |   |  | 11: 10,5* ↗<br>12: 10,1 ↗<br>13: 10,8* →<br>14: 10,1 →<br>15: 9,9 ↘<br>16: 10,2* ↗<br>17: 10,5* →<br>18: 10,2* ↗<br>19: 10,2* ↑<br>20: 10,6* ↘<br>Serie 99,0<br>Totalt 196,0 |
| 40 shot    |  | 21: 10,4* ↗<br>22: 10,7* ↘<br>23: 10,2* ↗<br>24: 10,5* →<br>25: 10,6* →<br>26: 10,0 →<br>27: 10,2* →<br>28: 10,2* →<br>29: 10,5* ←<br>30: 10,7* ↘<br>Serie 100,0<br>Totalt 296,0 | 40 shot    |
|            |   |  | 31: 9,6 ↘<br>32: 10,7* ↘<br>33: 9,3 ↗<br>34: 10,3* ↘<br>35: 10,0 ↘<br>36: 10,8* ↘<br>37: 10,3* ↗<br>38: 9,4 ↗<br>39: 10,1 →<br>40: 9,9 →<br>Serie 96,0<br>Totalt 392,0       |
| Umeå skf   |   |  |  |

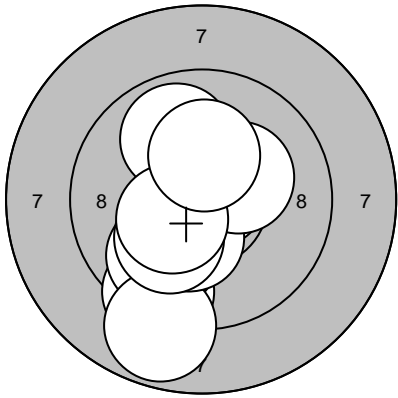
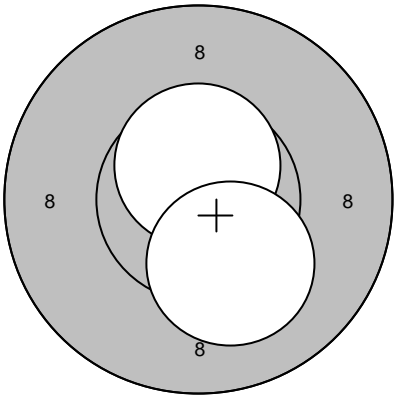
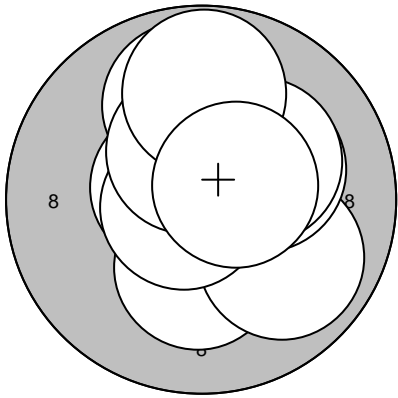
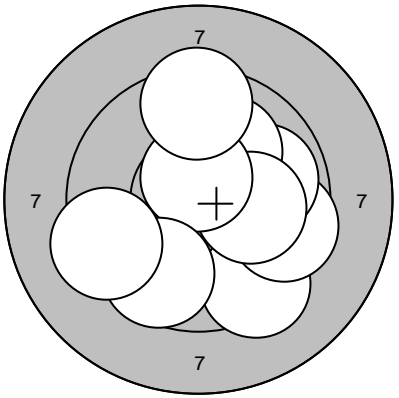
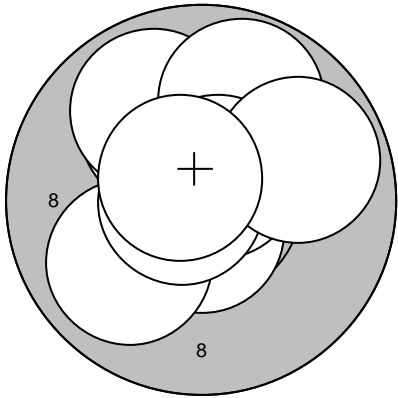
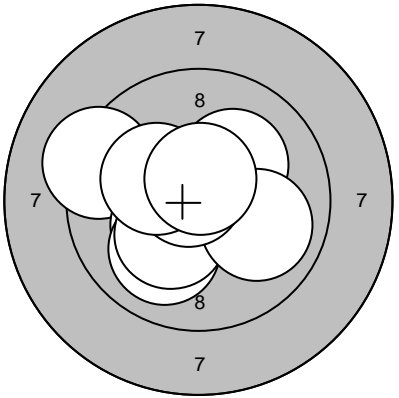
| Skjutlag   | Tavla   | Monica Häggström   |   |
|------------|---|--|---|
| 2          | 3   |  |   |
| STPL       | Ramselefors   |  |   |
| 2009-01-17 | Skyttiaden 2009   | Umeå skytteallians   |   |
| Sight      |    | 1: 9,3 ↘<br>2: 10,7* →<br>3: 9,9 ↘<br>4: 8,8 ↘<br>5: 9,9 ↗<br>6: 10,3* ↘<br>7: 10,2* ↘<br>8: 10,3* →<br>9: 10,4* ↙<br>10: 10,3* ↑<br>Serie 95,0<br>Totalt 0,0          | Sight<br>   |
|            |   |  | 11: 10,6* ↑<br>12: 10,2* ↘<br>Serie 20,0<br>Totalt 0,0  |
| 40 shot    |   | 1: 10,6* ↙<br>2: 10,2* ↓<br>3: 9,9 ↑<br>4: 9,9 ↘<br>5: 10,7* ↙<br>6: 10,2* →<br>7: 10,4* ↑<br>8: 10,2* →<br>9: 9,8 ↑<br>10: 10,5* →<br>Serie 97,0<br>Totalt 97,0       | 40 shot<br>  |
|            |   |  | 11: 9,3 ↘<br>12: 9,5 →<br>13: 9,9 →<br>14: 10,7* ↗<br>15: 10,1 ↗<br>16: 10,1 →<br>17: 10,6* ↑<br>18: 9,6 ↘<br>19: 9,3 ↙<br>20: 9,4 ↑<br>Serie 94,0<br>Totalt 191,0          |
| 40 shot    |  | 21: 10,1 ↗<br>22: 10,1 ↑<br>23: 10,6* ↓<br>24: 9,9 ↗<br>25: 9,8 ↑<br>26: 10,7* ↗<br>27: 9,9 ↙<br>28: 10,7* ↙<br>29: 9,8 →<br>30: 10,6* ↗<br>Serie 96,0<br>Totalt 287,0 | 40 shot<br>   |
|            |   |  | 31: 9,2 ↙<br>32: 10,3* ↙<br>33: 10,0 ↘<br>34: 10,7* ↙<br>35: 10,2* ↗<br>36: 10,2* ↘<br>37: 9,9 →<br>38: 10,7* ↗<br>39: 10,2* ↙<br>40: 10,6* ↑<br>Serie 98,0<br>Totalt 385,0 |
| Umeå skf   |   |  |   |

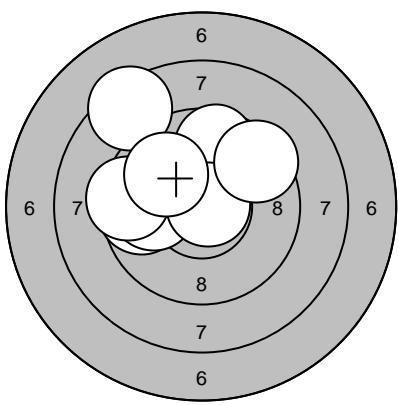
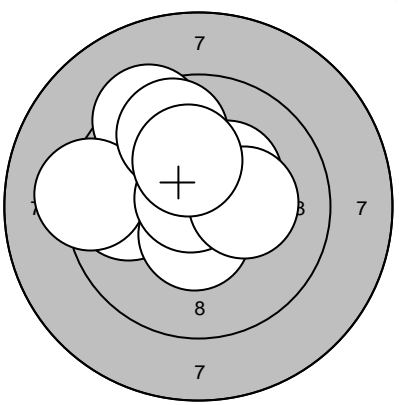
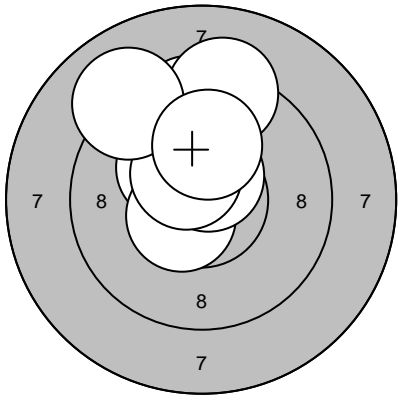
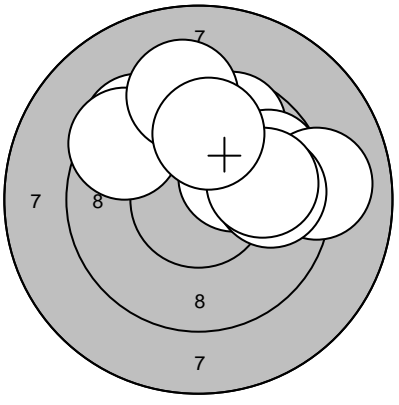
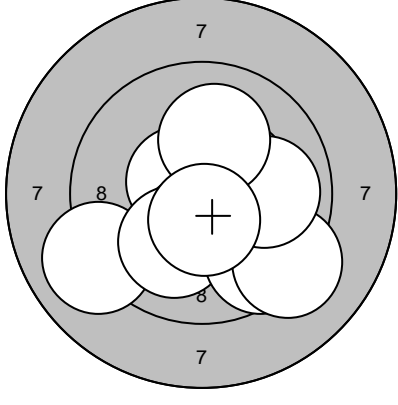
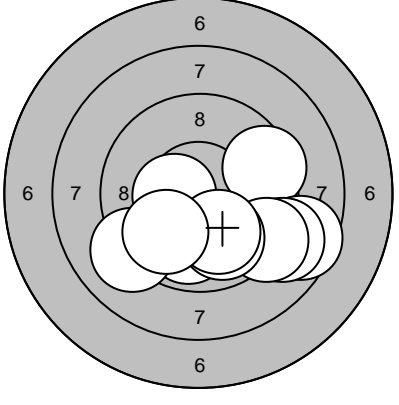
|                      |   |  |                    |  |   |
|----------------------|---|--|--------------------|--|---|
| Skjutlag<br><b>2</b> | Tavla<br><b>4</b>   | <b>Sanna Olsson</b>  |                    |  |   |
| STPL                 |   | Umeå   |                    |  |   |
| 2009-01-17           |   | Skyttiaden 2009  | Umeå skytteallians |  |   |
| Sight                |    | 1: 9,5 ←<br>2: 9,7 ←<br>3: 10,0 ←<br>4: 10,1 ↑<br>5: 9,7 ↑<br>6: 10,8* →<br>7: 8,4 ↗<br>8: 9,4 ←<br>9: 10,0 ↖<br>10: 9,5 ↗<br>Serie 93,0<br>Totalt 0,0                 | Sight              |    | 11: 9,4 ↗<br>12: 10,3* ↗<br>13: 9,8 ←<br>14: 9,2 ←<br>15: 9,7 ↑<br>16: 10,5* ↓<br>17: 10,8* ↗<br>18: 10,2* →<br>19: 10,2* ↑<br>Serie 86,0<br>Totalt 0,0         |
| 40 shot              |   | 1: 10,3* ↖<br>2: 9,9 ↑<br>3: 10,5* ↖<br>4: 10,2* ↑<br>5: 9,6 ↑<br>6: 10,6* ↑<br>7: 9,2 ↑<br>8: 10,5* ↖<br>9: 9,0 ↖<br>10: 10,1 ↑<br>Serie 96,0<br>Totalt 96,0          | 40 shot            |   | 11: 9,7 ↗<br>12: 9,7 ↗<br>13: 9,1 →<br>14: 10,3* ↗<br>15: 9,5 ↗<br>16: 9,8 →<br>17: 9,5 ↖<br>18: 9,9 →<br>19: 9,3 ↑<br>20: 9,9 ↑<br>Serie 91,0<br>Totalt 187,0  |
| 40 shot              |  | 21: 9,0 ↖<br>22: 10,6* ↖<br>23: 10,4* ↓<br>24: 10,1 ↓<br>25: 10,3* →<br>26: 9,5 ↘<br>27: 9,2 ↘<br>28: 9,9 →<br>29: 10,1 ↑<br>30: 10,5* ↓<br>Serie 96,0<br>Totalt 283,0 | 40 shot            |  | 31: 9,9 ↓<br>32: 9,5 →<br>33: 10,5* ←<br>34: 8,6 ↘<br>35: 8,9 ↘<br>36: 9,2 ↘<br>37: 9,9 ↓<br>38: 9,1 ↖<br>39: 10,0 ↓<br>40: 9,9 ↘<br>Serie 90,0<br>Totalt 373,0 |
| <b>Umeå skf</b>      |   |  |                    |  |   |

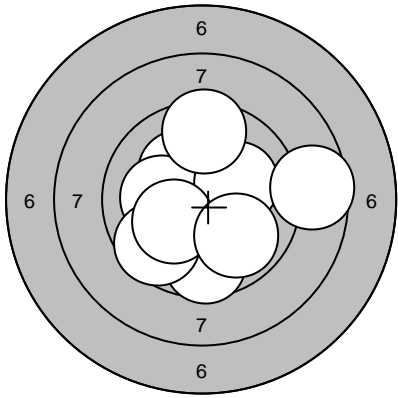
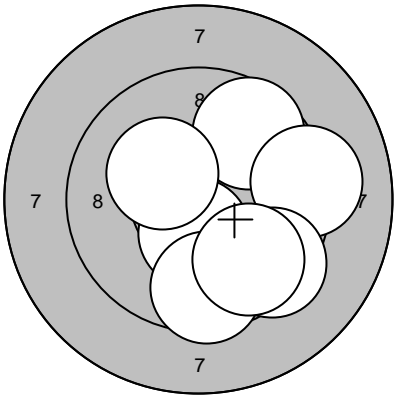
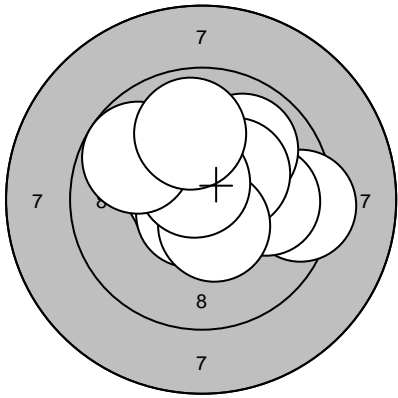
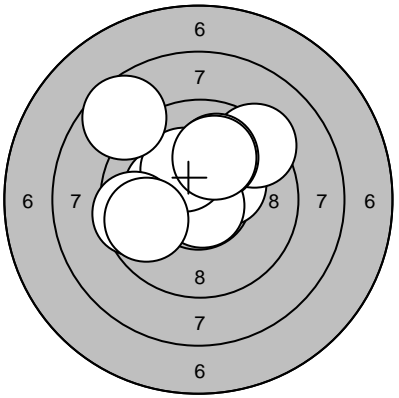
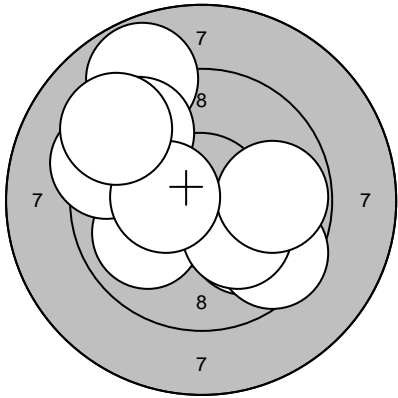
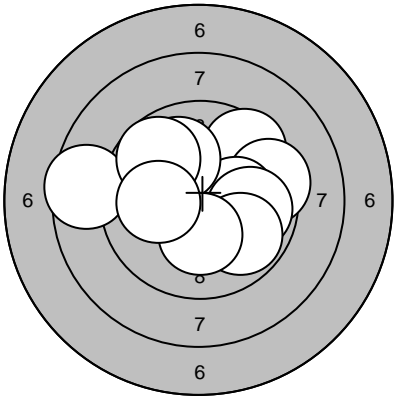
| Skjutlag   | Tavla   | Hanna Ögren  |   |  |
|------------|---|--|---|--|
| STPL       | Ramselefors   |  |   |  |
| 2009-01-17 | Skyttiaden 2009   | Umeå skytteallians   |   |  |
| Sight      |    | 1: 10,2* ↖<br>2: 10,1 ←<br>3: 10,3* ↓<br>4: 10,1 →<br>5: 9,6 ↓<br>6: 9,6 ←<br>7: 10,2* ↙<br>8: 9,9 ↓<br>9: 8,6 →<br>10: 9,5 ↑<br>Serie 94,0<br>Totalt 0,0          | Sight<br>     | 11: 10,4* ↓<br>12: 9,6 ↗<br>13: 10,2* ↖<br>14: 9,2 →<br>15: 9,5 ↓<br>16: 9,4 ↘<br>17: 9,7 ↘<br>Serie 65,0<br>Totalt 0,0  |
| 40 shot    |   | 1: 9,4 →<br>2: 9,9 →<br>3: 9,9 ↗<br>4: 10,6* ↖<br>5: 10,7* ↓<br>6: 10,3* ↗<br>7: 10,5* ↓<br>8: 10,7* ↗<br>9: 9,8 ↖<br>10: 9,9 ↑<br>Serie 95,0<br>Totalt 95,0       | 40 shot<br>  | 11: 10,3* ↗<br>12: 9,3 ↗<br>13: 10,3* ↖<br>14: 10,0 ↗<br>15: 10,8* ↓<br>16: 10,3* ↗<br>17: 9,6 ←<br>18: 9,8 ←<br>19: 10,0 ↗<br>20: 8,7 ↖<br>Serie 95,0<br>Totalt 190,0 |
| 40 shot    |  | 21: 8,8 ↖<br>22: 10,0 ←<br>23: 10,0 ↓<br>24: 9,5 ↓<br>25: 9,5 ↗<br>26: 9,3 ↗<br>27: 10,2* ↓<br>28: 9,8 →<br>29: 10,4* ←<br>30: 9,2 ↗<br>Serie 93,0<br>Totalt 283,0 | 40 shot<br> | 31: 9,5 ↗<br>32: 9,4 →<br>33: 10,2* →<br>34: 8,6 ←<br>35: 9,9 →<br>36: 10,0 ↗<br>37: 9,8 ↓<br>38: 9,8 ↗<br>39: 10,2* ↓<br>40: 10,1 ←<br>Serie 93,0<br>Totalt 376,0     |
| Umeå skf   |   |  |   |  |

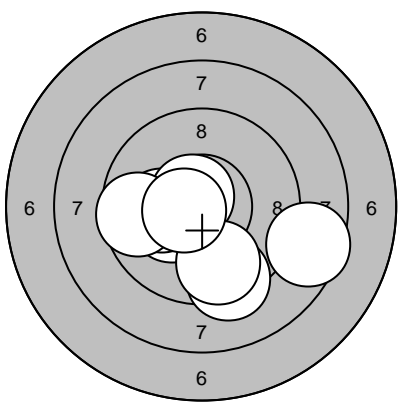
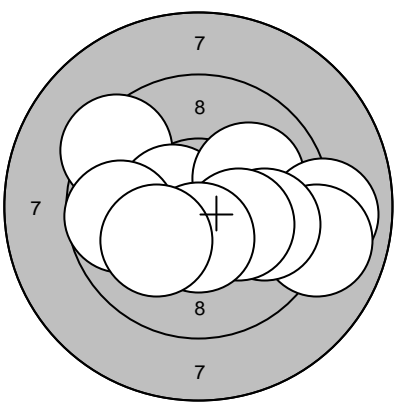
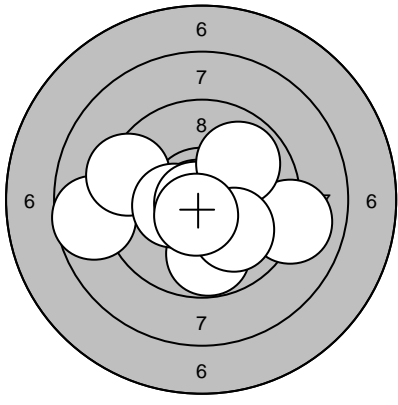
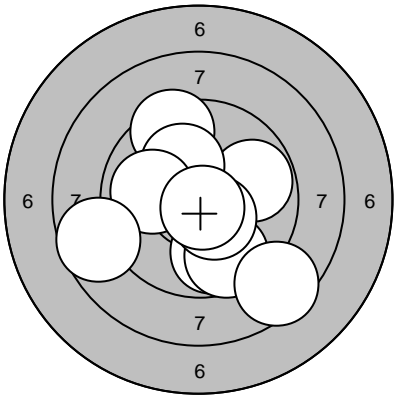
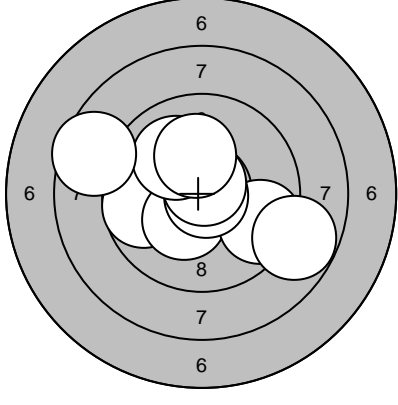
|                      |   |   |  |
|----------------------|---|---|--|
| Skjutlag<br><b>2</b> | Tavla<br><b>6</b>   | <b>Johan Nilsson</b>  |  |
| STPL                 |   | Ramselefors   |  |
| 2009-01-17           |   | Skyttiaden 2009   | Umeå skytteallians   |
| Sight                |    | 1: 9,3 ↘<br>2: 10,3* ←<br>3: 10,1 ←<br>4: 10,7* ↗<br>5: 8,5 →<br>6: 9,7 ↘<br>7: 9,6 ←<br>8: 10,6* ←                                       | 40 shot<br>  |
|                      |   | Serie 75,0  | Serie 95,0   |
|                      |   | Totalt 0,0  | Totalt 95,0  |
| 40 shot              |   | 11: 8,7 ←<br>12: 9,0 →<br>13: 9,8 ↘<br>14: 10,8* ←<br>15: 9,3 ←<br>16: 10,4* ←<br>17: 10,8* ↘<br>18: 9,9 ↗<br>19: 10,0 ↘<br>20: 10,6* ↘   | 40 shot<br> |
|                      |   | Serie 94,0  | Serie 92,0   |
|                      |   | Totalt 189,0  | Totalt 281,0   |
| 40 shot              |  | 31: 10,9* ↗<br>32: 9,7 ←<br>33: 10,3* ↘<br>34: 9,5 →<br>35: 10,8* →<br>36: 10,7* ↗<br>37: 10,0 ↗<br>38: 8,8 →<br>39: 8,6 ←<br>40: 10,2* ↑ |  |
|                      |   | Serie 94,0  |  |
|                      |   | Totalt 375,0  |  |
| <b>Umeå skf</b>      |   |   |  |

| Skjutlag   | Tavla           | Emelie Edlund   |  |
|------------|-----------------|---|--|
| 2          | 7               |   |  |
| STPL       | Umeå            |   |  |
| 2009-01-17 | Skyttiaden 2009 | Umeå skytteallians  |  |
| Sight      |                 | 1: 9,5 ←<br>2: 5,9 →<br>3: 9,8 →<br>4: 8,9 ↑<br>5: 8,3 ↑<br>6: 8,9 ←<br>7: 9,5 →<br>8: 8,7 →<br>9: 9,7 ←<br>10: 9,4 →<br>Serie 82,0<br>Totalt 0,0                     | Sight  |
|            |                 |   | 11: 9,9 ↑<br>12: 10,2* ←<br>13: 9,6 ↖<br>14: 9,6 ↑<br>15: 10,0 ↗<br>16: 9,2 ←<br>17: 9,6 ↑<br>18: 9,3 ←<br>Serie 74,0<br>Totalt 0,0                                  |
| 40 shot    |                 | 1: 9,6 ↑<br>2: 9,6 ←<br>3: 10,6* →<br>4: 10,1 ↖<br>5: 9,1 ←<br>6: 10,8* ↘<br>7: 8,9 ←<br>8: 9,9 ↑<br>9: 10,4* ↘<br>10: 9,7 →<br>Serie 93,0<br>Totalt 93,0             | 40 shot  |
|            |                 |   | 11: 9,2 ↘<br>12: 9,4 →<br>13: 10,0 ↓<br>14: 10,7* →<br>15: 9,5 ↘<br>16: 9,7 ←<br>17: 10,1 ←<br>18: 9,7 ↗<br>19: 10,8* ←<br>20: 10,3* ↘<br>Serie 95,0<br>Totalt 188,0 |
| 40 shot    |                 | 21: 9,1 ←<br>22: 8,9 ↘<br>23: 10,2* ↘<br>24: 10,3* ↘<br>25: 9,1 →<br>26: 10,6* ↘<br>27: 10,2* ↘<br>28: 9,5 ↘<br>29: 10,1 →<br>30: 9,2 ↘<br>Serie 94,0<br>Totalt 282,0 | 40 shot  |
|            |                 |   | 31: 9,2 ↖<br>32: 10,5* ↑<br>33: 9,8 →<br>34: 9,8 ↘<br>35: 9,6 →<br>36: 10,8* ↑<br>37: 8,5 ↘<br>38: 10,8* ←<br>39: 10,2* →<br>40: 8,4 ↘<br>Serie 92,0<br>Totalt 374,0 |
| Umeå skf   |                 |   |  |

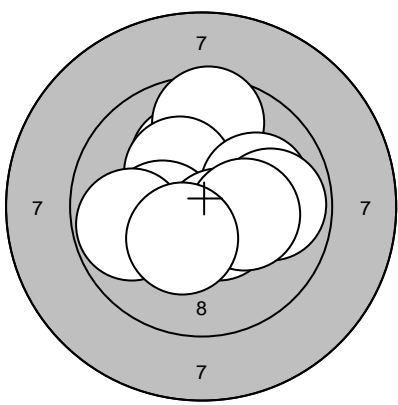
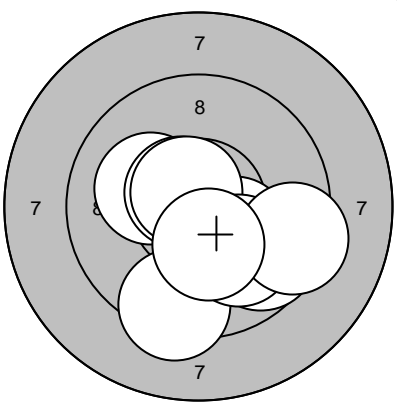
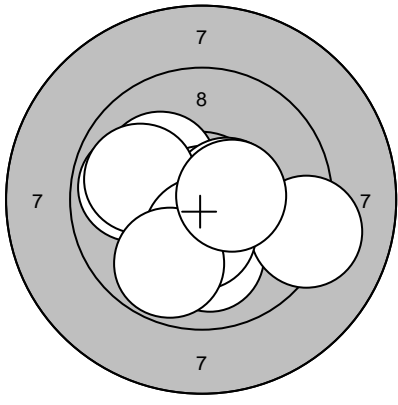
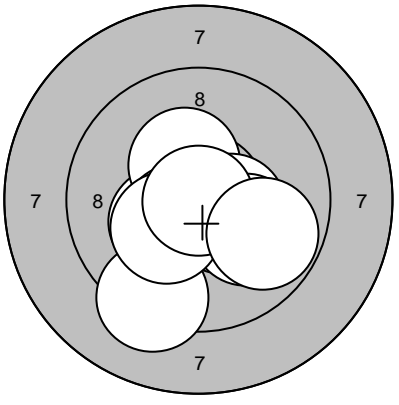
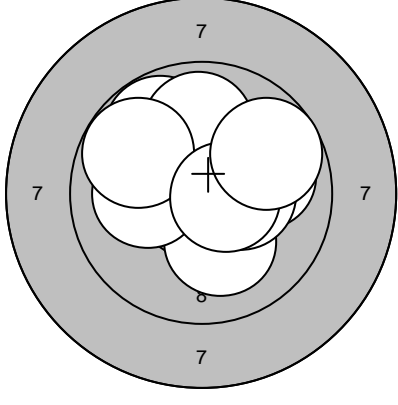
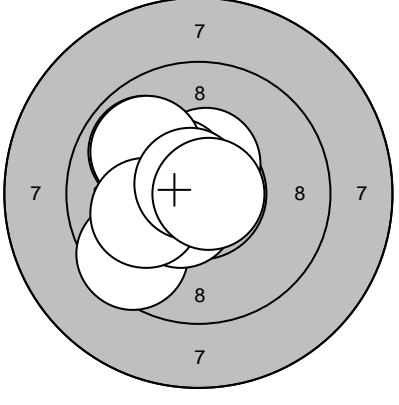
| Skjutlag   | Tavla   | Maria Hägglund  |   |
|------------|---|---|---|
| 2          | 8   |   |   |
| STPL       | Ramselefors   |   |   |
| 2009-01-17 | Skyttiaden 2009   | Umeå skytteallians  |   |
| Sight      |    | 1: 10,2* ↗<br>2: 9,6 ↑<br>3: 10,3* ↗<br>4: 10,3* ←<br>5: 10,0 →<br>6: 9,8 →<br>7: 10,5* ↓<br>8: 10,2* →<br>9: 9,8 ←<br>10: 10,4* ↙<br>Serie 97,0<br>Totalt 0,0        | Sight   |
|            |   |   | 11: 9,4 ↓<br>12: 10,1 ↖<br>13: 10,6* ↗<br>14: 10,2* ↓<br>15: 10,6* ↗<br>16: 9,7 ↓<br>17: 10,0 ↓<br>18: 9,4 ↓<br>19: 10,3* ↓<br>Serie 87,0<br>Totalt 0,0                     |
| 40 shot    |   | 1: 10,1 ↗<br>2: 9,9 ←<br>3: 10,9* ↓<br>4: 10,5* →<br>5: 9,9 ↖<br>6: 10,0 ↓<br>7: 9,2 →<br>8: 10,4* ↓<br>9: 9,8 ↓<br>10: 10,5* →<br>Serie 96,0<br>Totalt 96,0          | 40 shot    |
|            |   |   | 11: 10,3* ←<br>12: 10,4* ↑<br>13: 9,2 ↓<br>14: 10,4* ↓<br>15: 10,4* →<br>16: 10,5* ↙<br>17: 10,1 ↓<br>18: 10,3* ↙<br>19: 10,9* ↓<br>20: 9,8 ↘<br>Serie 98,0<br>Totalt 194,0 |
| 40 shot    |  | 21: 10,1 ↓<br>22: 10,0 →<br>23: 9,8 ↗<br>24: 10,4* ↑<br>25: 10,1 ←<br>26: 9,9 ↑<br>27: 10,3* →<br>28: 9,8 ↗<br>29: 10,6* →<br>30: 9,7 ↗<br>Serie 96,0<br>Totalt 290,0 | 40 shot   |
|            |   |   | 31: 9,5 ↙<br>32: 10,8* ↑<br>33: 10,5* ↑<br>34: 9,9 ↖<br>35: 10,5* ↙<br>36: 10,5* ↗<br>37: 9,9 ↗<br>38: 10,1 ←<br>39: 10,7* ↗<br>40: 10,8* →<br>Serie 97,0<br>Totalt 387,0   |
| Umeå skf   |   |   |   |

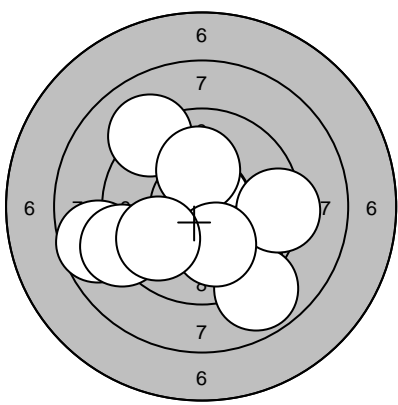
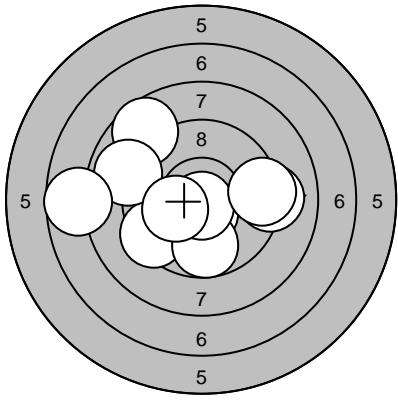
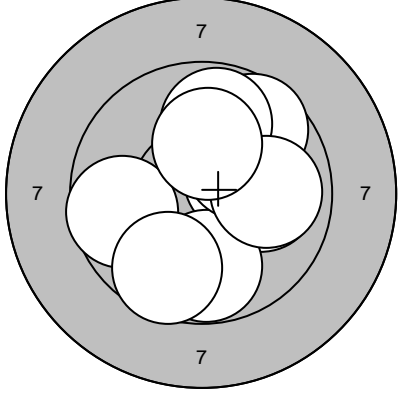
|                      |   |   |                    |
|----------------------|---|---|--------------------|
| Skjutlag<br><b>2</b> | Tavla<br><b>9</b>   | <b>Emil Bergman</b>   |                    |
| STPL                 |   | Umeå  |                    |
| 2009-01-17           |   | Skyttiaden 2009   | Umeå skytteallians |
| Sight                |    | 1: 10,8* →<br>2: 8,7 ←<br>3: 9,1 ↗<br>4: 9,7 ↘<br>5: 10,2* ↑<br>6: 8,9 ↘<br>7: 9,1 ←<br>8: 9,3 →<br>9: 10,1 ↘<br>10: 9,8 ↙            | Sight              |
|                      |   | Serie 91,0  | 11: 9,4 →          |
|                      |   | Totalt 0,0  | 12: 9,8 ↗          |
|                      |   |   | 13: 10,0 ↗         |
|                      |   |   | 14: 9,9 ←          |
|                      |   |   | 15: 9,2 →          |
|                      |   |   | 16: 9,5 ←          |
|                      |   |   | 17: 10,5* ↘        |
|                      |   |   | 18: 10,4* ↘        |
|                      |   |   | Serie 75,0         |
|                      |   |   | Totalt 0,0         |
| 40 shot              |   | 1: 9,1 →<br>2: 10,6* ↘<br>3: 8,7 ↗<br>4: 9,4 ←<br>5: 9,7 ↘<br>6: 8,9 ←<br>7: 10,8* ↘<br>8: 9,3 →<br>9: 7,7 ←<br>10: 10,2* ←           | 40 shot            |
|                      |   | Serie 89,0  | 11: 10,7* ↘        |
|                      |   | Totalt 89,0   | 12: 10,1 ←         |
|                      |   |   | 13: 9,3 ←          |
|                      |   |   | 14: 8,6 ←          |
|                      |   |   | 15: 9,8 ↘          |
|                      |   |   | 16: 10,9* ←        |
|                      |   |   | 17: 9,1 ←          |
|                      |   |   | 18: 8,9 →          |
|                      |   |   | 19: 10,3* ↘        |
|                      |   |   | 20: 10,7* ↗        |
|                      |   |   | Serie 93,0         |
|                      |   |   | Totalt 182,0       |
| 40 shot              |  | 21: 10,0 →<br>22: 10,3* →<br>23: 9,8 ↘<br>24: 10,2* ↗<br>25: 9,7 ←<br>26: 9,6 ↗<br>27: 9,8 ↑<br>28: 9,9 →<br>29: 10,2* ↑<br>30: 9,6 ↘ | 40 shot            |
|                      |   | Serie 94,0  | 31: 8,9 ↘          |
|                      |   | Totalt 276,0  | 32: 9,6 ↘          |
|                      |   |   | 33: 10,6* ↘        |
|                      |   |   | 34: 10,4* →        |
|                      |   |   | 35: 8,8 ↘          |
|                      |   |   | 36: 8,8 →          |
|                      |   |   | 37: 9,9 ↘          |
|                      |   |   | 38: 10,6* ↘        |
|                      |   |   | 39: 9,4 ↘          |
|                      |   |   | 40: 10,0 →         |
|                      |   |   | Serie 91,0         |
|                      |   |   | Totalt 367,0       |
| <b>Umeå skf</b>      |   |   |                    |

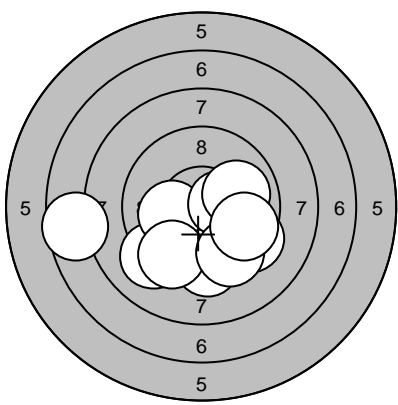
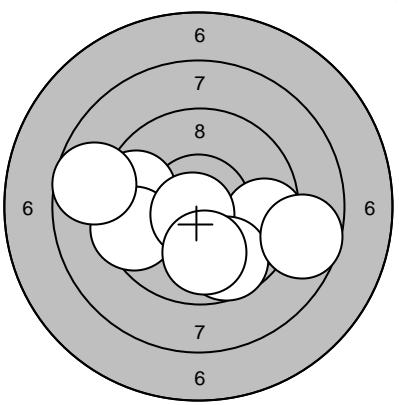
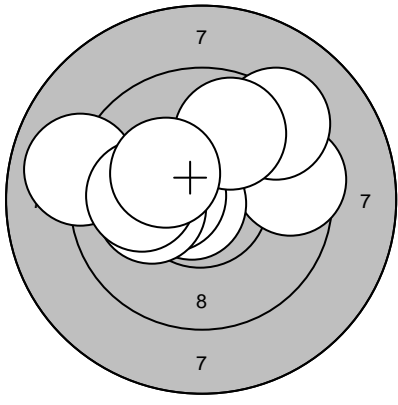
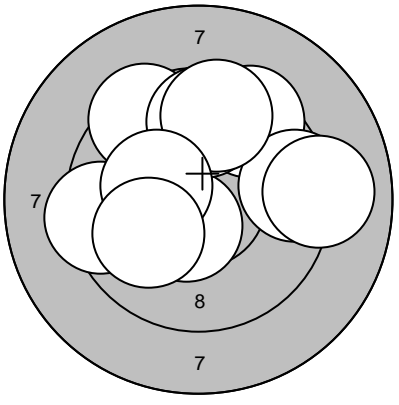
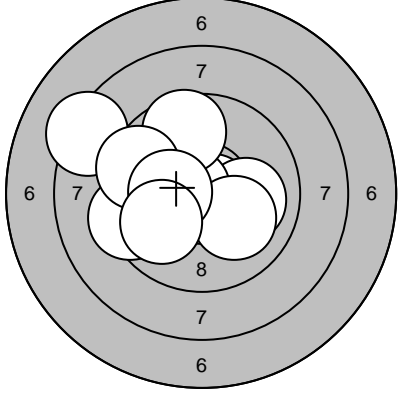
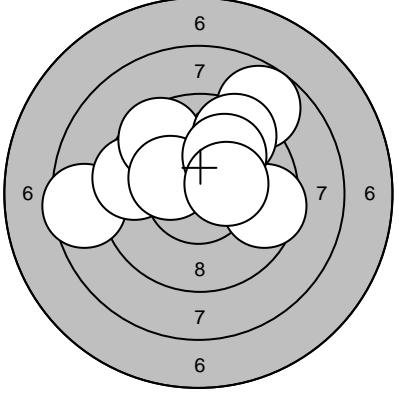

|                      |   |  |                    |  |   |
|----------------------|---|--|--------------------|--|---|
| Skjutlag<br><b>2</b> | Tavla<br><b>10</b>  | <b>Marie Fjällström</b>  |                    |  |   |
| STPL                 |   | Ramselefors  |                    |  |   |
| 2009-01-17           |   | Skyttiaden 2009  | Umeå skytteallians |  |   |
| Sight                |    | 1: 9,2 ↙<br>2: 10,2* ←<br>3: 9,5 ↓<br>4: 9,4 →<br>5: 9,5 ↙<br>6: 10,4* →<br>7: 9,5 ↘<br>8: 10,0 →<br>9: 7,6 ←<br>10: 9,7 →<br>Serie 91,0<br>Totalt 0,0               | Sight              |    | 11: 9,6 ←<br>12: 9,5 ←<br>13: 9,5 →<br>14: 10,7* ↘<br>15: 8,7 ←<br>16: 9,7 ↓<br>17: 8,7 →<br>18: 10,0 ↓<br>Serie 72,0<br>Totalt 0,0                                 |
| 40 shot              |   | 1: 9,5 →<br>2: 10,5* ↑<br>3: 9,3 ↗<br>4: 10,8* ←<br>5: 10,5* ←<br>6: 9,8 ↗<br>7: 10,1 ←<br>8: 9,0 ←<br>9: 10,0 ←<br>10: 10,3* ↗<br>Serie 96,0<br>Totalt 96,0         | 40 shot            |   | 11: 10,5* ↘<br>12: 9,4 ↗<br>13: 9,5 ↗<br>14: 9,4 →<br>15: 9,4 ←<br>16: 9,7 ↑<br>17: 9,6 ↑<br>18: 10,3* ←<br>19: 10,0 ←<br>20: 9,0 →<br>Serie 93,0<br>Totalt 189,0   |
| 40 shot              |  | 21: 10,7* →<br>22: 10,0 →<br>23: 10,7* ←<br>24: 8,3 ↖<br>25: 9,4 ←<br>26: 10,1 ↘<br>27: 9,6 ↗<br>28: 9,5 ↖<br>29: 10,3* ←<br>30: 9,9 ↘<br>Serie 94,0<br>Totalt 283,0 | 40 shot            |  | 31: 8,5 ←<br>32: 8,8 ↗<br>33: 10,2* ↗<br>34: 9,6 ←<br>35: 9,6 ↖<br>36: 9,5 ↗<br>37: 9,5 →<br>38: 10,3* ↖<br>39: 10,0 ↗<br>40: 10,3* →<br>Serie 92,0<br>Totalt 375,0 |
| <b>Umeå skf</b>      |   |  |                    |  |   |

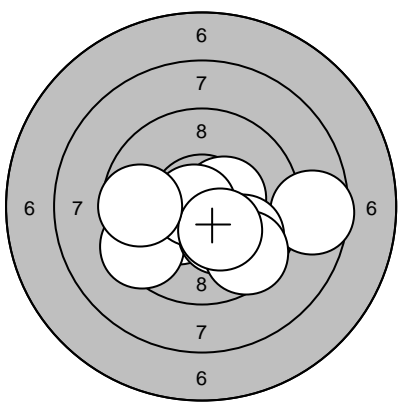
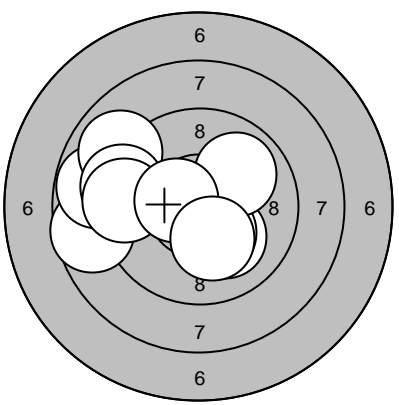
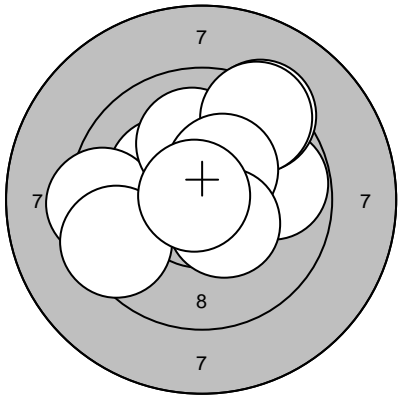
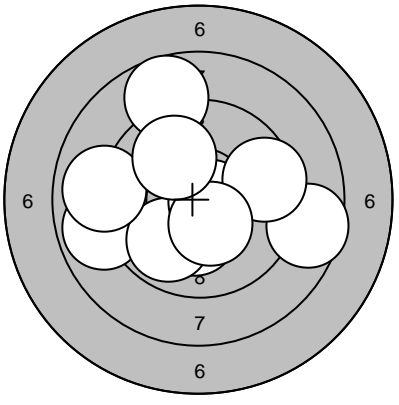
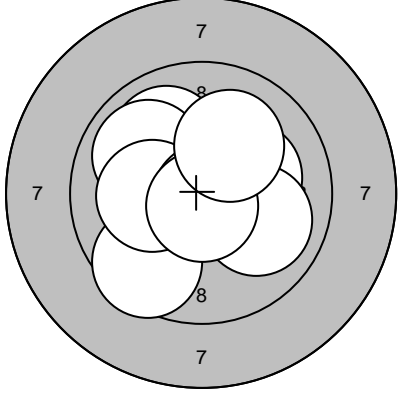
|   |                    |   |              |
|---|--------------------|---|--------------|
| Skjutlag<br><b>2</b>  | Tavla<br><b>11</b> | <b>Malin Adolfsson</b>  |              |
| STPL  |                    | Umeå  |              |
| 2009-01-17  |                    | Skyttiaden 2009   |              |
| Sight   |                    | Umeå skytteallians  |              |
|    | 1: 8,6 →           |   | 1: 8,7 ←     |
|   | 2: 10,4* ↙         |   | 2: 10,1 ↘    |
|   | 3: 9,5 ↙           |   | 3: 8,8 ←     |
|   | 4: 10,3* ↘         |   | 4: 10,3* ↘   |
|   | 5: 10,4* →         |   | 5: 9,0 ↗     |
|   | 6: 9,9 ↘           |   | 6: 9,9 ↗     |
|   | 7: 10,8* ←         |   | 7: 9,3 ←     |
|   | 8: 9,6 ↘           |   | 8: 9,4 ←     |
|   | 9: 10,3* ↘         |   | 9: 10,5* ←   |
|   | 10: 9,7 ←          |   | 10: 10,2* ↘  |
|   | Serie 94,0         |   | Serie 92,0   |
|   | Totalt 0,0         |   | Totalt 92,0  |
|   | 11: 9,8 →          |  | 21: 10,2* ↓  |
|   | 12: 10,3* ↗        |   | 22: 8,9 ←    |
|   | 13: 9,3 ↗          |   | 23: 9,9 ↘    |
|   | 14: 9,4 ←          |   | 24: 10,7* →  |
|   | 15: 9,4 ↙          |   | 25: 8,7 ↗    |
|   | 16: 10,1 ↑         |   | 26: 8,6 →    |
|   | 17: 9,4 ↗          |   | 27: 9,5 →    |
|   | 18: 10,4* ↗        |   | 28: 9,0 ←    |
|   | 19: 10,4* ↘        |   | 29: 10,4* ↘  |
|   | 20: 10,8* ↗        |   | 30: 10,0 ↗   |
|   | Serie 95,0         |   | Serie 91,0   |
|   | Totalt 187,0       |   | Totalt 278,0 |
|  | 31: 10,8* ↙        |   |              |
|   | 32: 10,0 ↗         |   |              |
|   | 33: 9,5 ↙          |   |              |
|   | 34: 9,9 ↗          |   |              |
|   | 35: 10,2* ←        |   |              |
|   | 36: 10,2* →        |   |              |
|   | 37: 10,8* ↘        |   |              |
|   | 38: 10,0 →         |   |              |
|   | 39: 10,7* ↘        |   |              |
|   | 40: 10,1 ↗         |   |              |
|   | Serie 98,0         |   |              |
|   | Totalt 376,0       |   |              |
| <b>Umeå skf</b>   |                    |   |              |

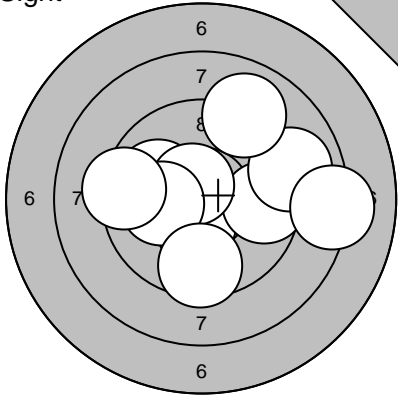
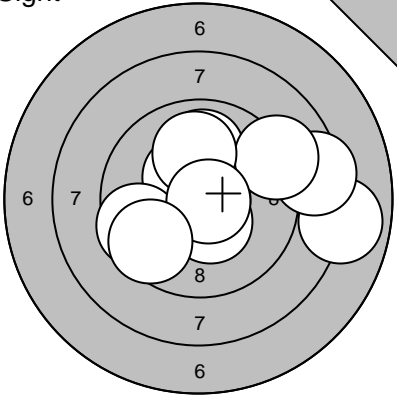
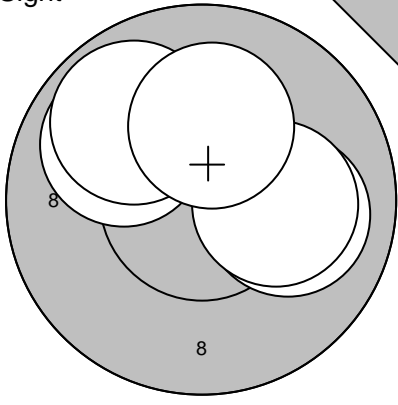
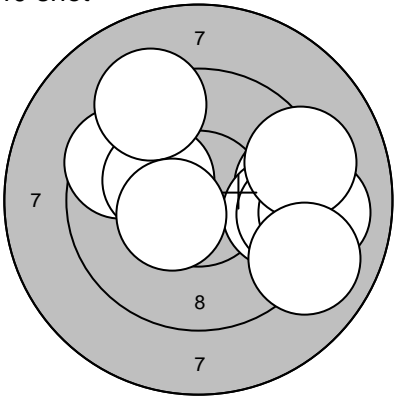
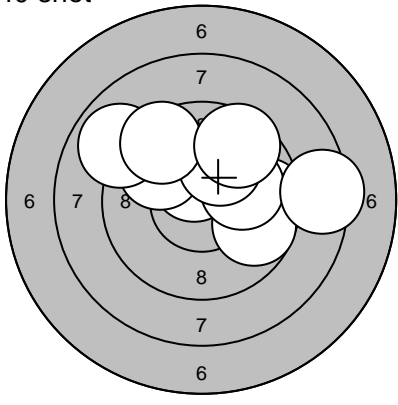
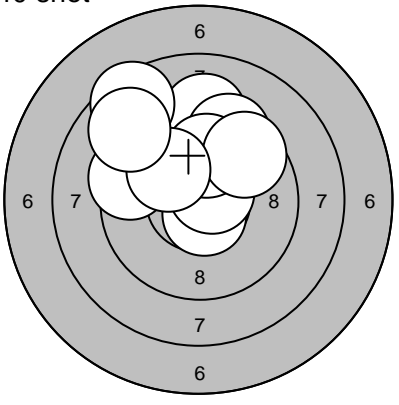
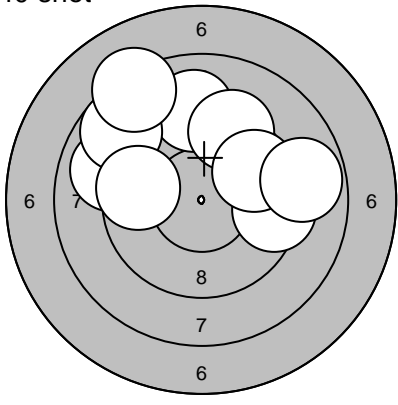
|  |  |   |  |
|--|--|---|--|
| Skjutlag<br><b>2</b>   | Tavla<br><b>12</b>   | <b>Marlene Forsell</b>  |  |
| STPL   |  | Ramselefors   |  |
| 2009-01-17   |  | Skyttiaden 2009   | Umeå skytteallians   |
| Sight<br>     | 1: 10,4* ↓<br>2: 9,6 →<br>3: 10,0 ↖<br>4: 10,6* ↗<br>5: 10,1 ←<br>6: 9,5 ↓<br>7: 9,3 ←<br>8: 9,0 →<br>9: 8,2 →<br>10: 9,0 ↗<br>Serie 93,0<br>Totalt 0,0          | Sight<br>     | 11: 10,4* ↗<br>12: 7,9 →<br>13: 10,0 ↑<br>14: 10,4* ↓<br>15: 8,5 →<br>16: 9,1 ↗<br>17: 10,0 ↑<br>18: 9,6 ↖<br>19: 10,7* ↘<br>20: 9,6 ↙<br>Serie 92,0<br>Totalt 0,0 |
| Sight<br>    | 21: 10,0 →<br>22: 9,9 ↗<br>23: 9,9 ↗<br>24: 10,1 →<br>25: 10,2* ↑<br>Serie 48,0<br>Totalt 0,0  | 40 shot<br>  | 1: 9,6 ↖<br>2: 9,5 →<br>3: 9,7 →<br>4: 10,3* ↗<br>5: 9,4 →<br>6: 9,1 →<br>7: 9,3 ↗<br>8: 10,5* ↖<br>9: 9,2 →<br>10: 9,0 ↘<br>Serie 92,0<br>Totalt 92,0             |
| 40 shot<br> | 11: 9,6 →<br>12: 9,7 ↘<br>13: 10,5* ↗<br>14: 9,9 ↗<br>15: 10,0 →<br>16: 8,9 ↗<br>17: 10,1 ↗<br>18: 8,4 →<br>19: 9,5 ↗<br>20: 9,6 ↗<br>Serie 91,0<br>Totalt 183,0 | 40 shot<br> | 21: 10,6* ↓<br>22: 9,2 ↑<br>23: 9,5 ↗<br>24: 9,4 ↖<br>25: 8,5 ↗<br>26: 10,6* ↗<br>27: 10,0 ↑<br>28: 9,6 ↗<br>29: 10,0 ↗<br>30: 8,9 ↖<br>Serie 92,0<br>Totalt 275,0 |
| 40 shot<br> | 31: 9,4 →<br>32: 9,0 ←<br>33: 9,1 ↑<br>34: 9,4 →<br>35: 8,7 ↗<br>36: 9,4 ↗<br>37: 8,3 ↗<br>38: 9,6 ←<br>39: 9,7 ↗<br>40: 8,8 →<br>Serie 87,0<br>Totalt 362,0     |   |  |
| <b>Umeå skf</b>  |  |   |  |

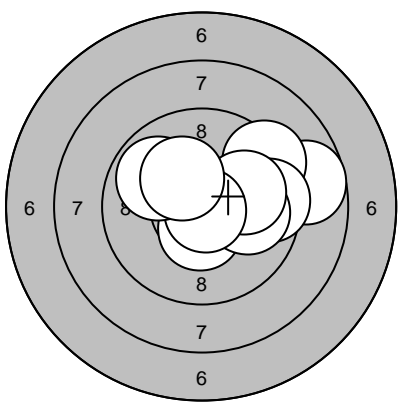
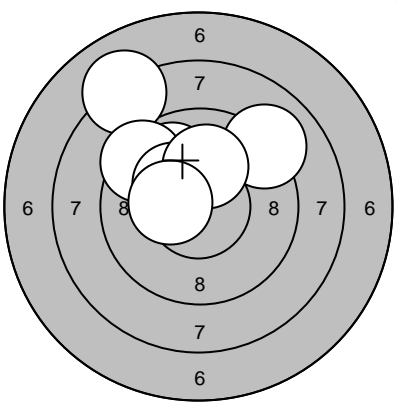
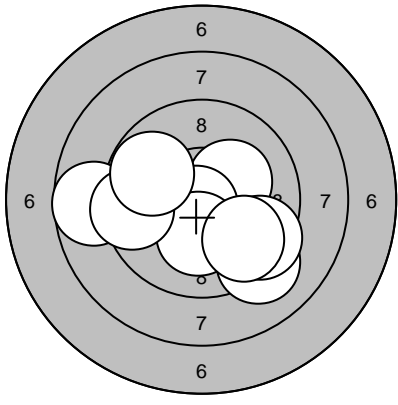
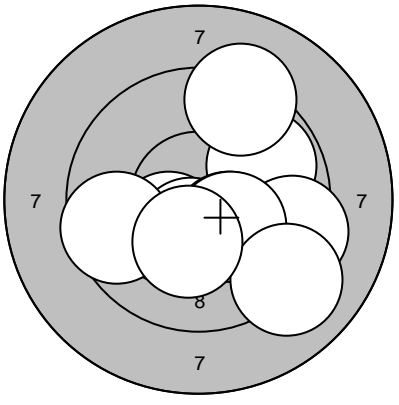
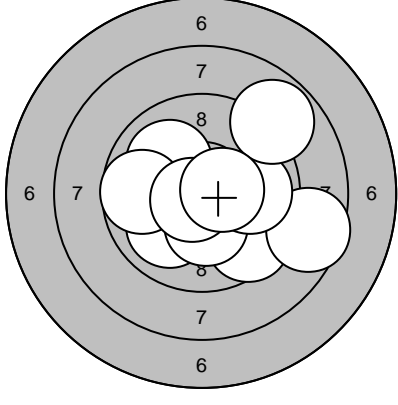
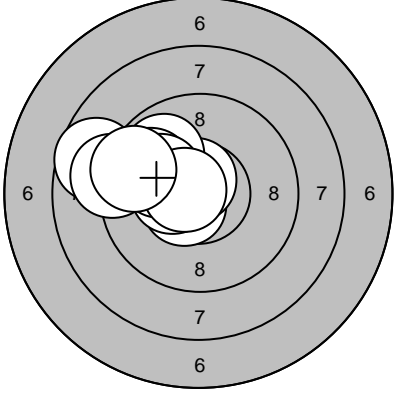
| Skjutlag   | Tavla           | Christoffer Wulff   |              |
|--|-----------------|---|--------------|
| 2  | 13              |   |              |
| STPL   | Umeå            |   |              |
| 2009-01-17   | Skyttiaden 2009 | Umeå skytteallians  |              |
| Sight<br>     | 1: 8,7 →        | Sight<br>     | 11: 9,9 ↗    |
|  | 2: 10,9* ↓      |   | 12: 9,1 ↗    |
|  | 3: 10,5* ↓      |   | 13: 8,1 ↗    |
|  | 4: 9,3 ↗        |   | 14: 9,5 ↗    |
|  | 5: 9,5 →        |   | 15: 10,3* ↗  |
|  | 6: 10,0 →       |   | 16: 10,1 ↑   |
|  | 7: 10,0 →       |   | 17: 10,4* ←  |
|  | 8: 10,8* ↓      |   |              |
|  | 9: 9,9 ↗        |   |              |
|  | 10: 10,2* ↗     |   |              |
|  | Serie 95,0      |   | Serie 65,0   |
|  | Totalt 0,0      |   | Totalt 0,0   |
| 40 shot<br>  | 1: 10,6* ↙      | 40 shot<br>  | 11: 10,3* ↙  |
|  | 2: 10,2* ↗      |   | 12: 9,8 ↗    |
|  | 3: 10,7* ↙      |   | 13: 10,4* ↓  |
|  | 4: 9,1 ↓        |   | 14: 10,3* ↓  |
|  | 5: 8,7 ←        |   | 15: 9,6 ←    |
|  | 6: 10,2* ↓      |   | 16: 9,2 ↗    |
|  | 7: 9,5 ←        |   | 17: 9,4 →    |
|  | 8: 9,5 ↘        |   | 18: 10,3* ↓  |
|  | 9: 9,8 ↗        |   | 19: 9,1 ↓    |
|  | 10: 9,7 ↓       |   | 20: 10,2* ↓  |
|  | Serie 93,0      |   | Serie 95,0   |
|  | Totalt 93,0     |   | Totalt 188,0 |
| 40 shot<br> | 21: 10,0 ↙      | 40 shot<br> | 31: 10,6* ↙  |
|  | 22: 9,5 ↓       |   | 32: 10,7* ↗  |
|  | 23: 10,3* ↓     |   | 33: 9,9 ↗    |
|  | 24: 8,6 →       |   | 34: 10,4* ←  |
|  | 25: 10,0 ↗      |   | 35: 8,7 ←    |
|  | 26: 9,9 →       |   | 36: 9,9 ↗    |
|  | 27: 9,7 ←       |   | 37: 10,1 ↗   |
|  | 28: 10,7* ↙     |   | 38: 9,1 ←    |
|  | 29: 8,8 ↗       |   | 39: 10,7* ←  |
|  | 30: 10,5* →     |   | 40: 9,5 ←    |
|  | Serie 93,0      |   | Serie 94,0   |
|  | Totalt 281,0    |   | Totalt 375,0 |

Umeå skf

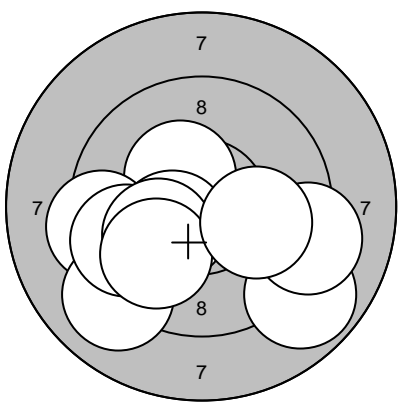
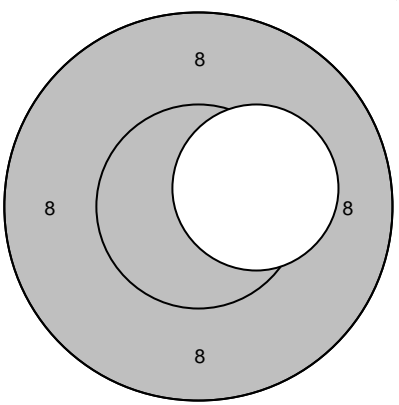
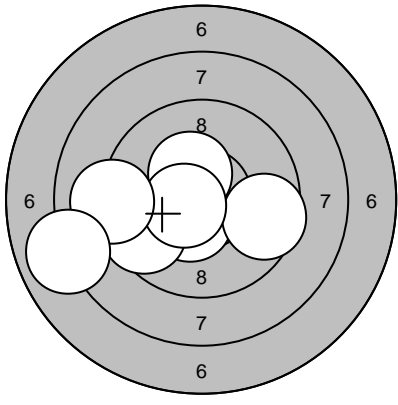
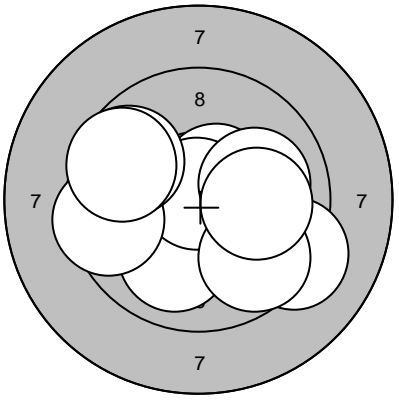
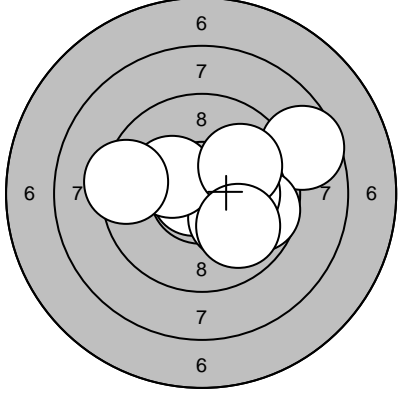
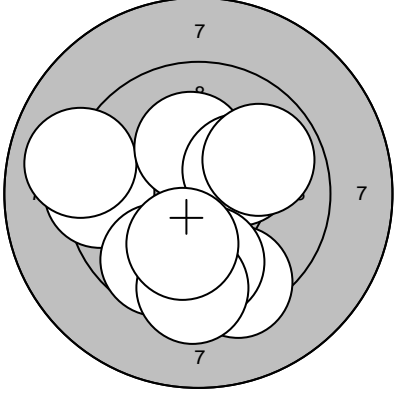
| Skjutlag   | Tavla   | Frida Folkesson  |   |
|------------|---|--|---|
| 2          | 14  |  |   |
| STPL       | Ramselefors   |  |   |
| 2009-01-17 | Skyttiaden 2009   | Umeå skytteallians   |   |
| Sight      |    | 1: 10,4* ↖<br>2: 9,3 ←<br>3: 9,0 ↙<br>4: 8,9 ↘<br>5: 9,2 →<br>6: 10,4* ←<br>7: 9,6 ←<br>8: 10,1 ←<br>9: 9,9 ↙<br>10: 10,0 →            | Sight<br>     |
|            | Serie 93,0  |  | 11: 10,3* →   |
|            | Totalt 0,0  |  | Serie 10,0  |
|            |   |  | Totalt 0,0  |
| 40 shot    |   | 1: 10,4* ↙<br>2: 10,6* ←<br>3: 9,3 ←<br>4: 9,7 ←<br>5: 10,4* ↗<br>6: 9,6 ←<br>7: 9,6 →<br>8: 10,6* ←<br>9: 9,1 ←<br>10: 8,0 ←          | 40 shot<br>  |
|            | Serie 93,0  |  | 11: 10,0 ↙  |
|            | Totalt 93,0   |  | 12: 10,5* ↗   |
|            |   |  | 13: 10,9* ↗   |
|            |   |  | 14: 9,5 ←   |
|            |   |  | 15: 10,0 →  |
|            |   |  | 16: 9,2 ↘   |
|            |   |  | 17: 9,7 ↖   |
|            |   |  | 18: 9,7 ↘   |
|            |   |  | 19: 9,6 ↖   |
|            |   |  | 20: 10,0 →  |
|            | Serie 93,0  |  | Serie 95,0  |
|            | Totalt 93,0   |  | Totalt 188,0  |
| 40 shot    |  | 21: 8,6 →<br>22: 10,0 →<br>23: 9,7 →<br>24: 10,2* →<br>25: 10,8* ←<br>26: 10,1 ↘<br>27: 10,3* ↗<br>28: 9,9 →<br>29: 9,4 ←<br>30: 9,9 ↘ | 40 shot<br> |
|            | Serie 94,0  |  | 31: 9,4 ←   |
|            | Totalt 282,0  |  | 32: 9,4 ↘   |
|            |   |  | 33: 9,0 ←   |
|            |   |  | 34: 9,7 ↘   |
|            |   |  | 35: 10,2* ↗   |
|            |   |  | 36: 10,2* ↗   |
|            |   |  | 37: 9,8 ↘   |
|            |   |  | 38: 9,4 ↘   |
|            |   |  | 39: 9,9 →   |
|            |   |  | 40: 10,1 ↘  |
|            | Serie 94,0  |  | Serie 93,0  |
|            | Totalt 282,0  |  | Totalt 375,0  |

Umeå skf

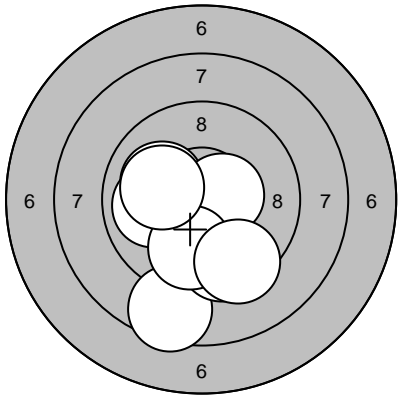
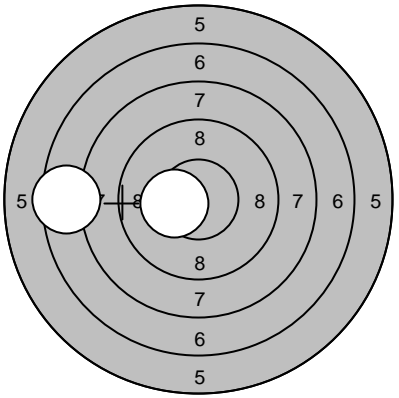
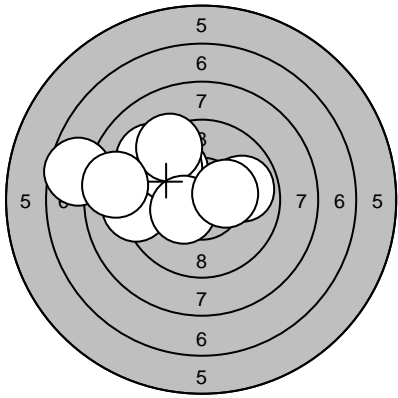
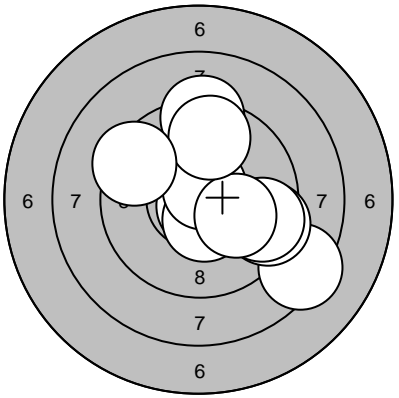
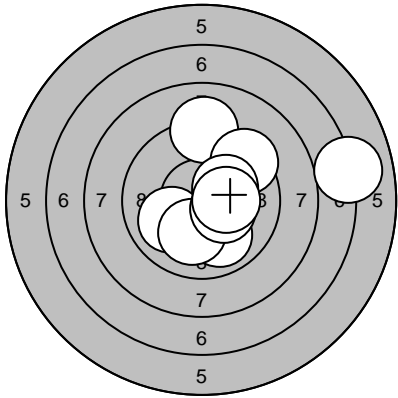
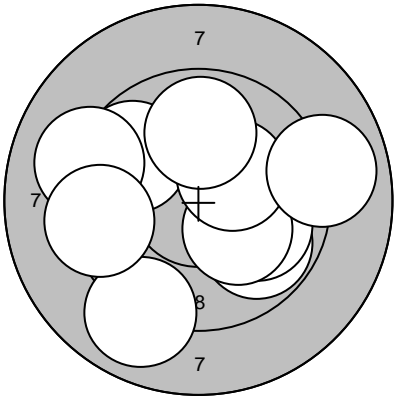
| Skjutlag   | Tavla   | Jessika Flodell  |   |
|------------|---|--|---|
| 2          | 15  |  |   |
| STPL       | Umeå  |  |   |
| 2009-01-17 | Skyttiaden 2009   | Umeå skytteallians   |   |
| Sight      |    | 1: 10,1 ←<br>2: 8,6 ↓<br>3: 10,2* ↓<br>4: 9,6 ↓<br>5: 10,0 ←<br>6: 10,0 ←<br>7: 10,5* →<br>8: 9,9 ↓<br>9: 10,1 ←<br>10: 9,4 ↓<br>Serie 95,0<br>Totalt 0,0              | Sight   |
|            |   |  | 11: 10,3* ←<br>12: 7,5 ←<br>Serie 17,0<br>Totalt 0,0  |
| 40 shot    |   | 1: 9,3 ←<br>2: 9,3 ↗<br>3: 9,9 ↗<br>4: 7,7 ←<br>5: 9,8 ↗<br>6: 9,9 →<br>7: 9,4 ↗<br>8: 10,4* ←<br>9: 8,7 ←<br>10: 10,3* →<br>Serie 89,0<br>Totalt 89,0                 | 40 shot    |
|            |   |  | 11: 10,8* ↓<br>12: 8,4 ↘<br>13: 9,3 ↑<br>14: 10,5* ↓<br>15: 10,7* ↗<br>16: 9,4 →<br>17: 9,6 →<br>18: 10,1 →<br>19: 9,6 ↑<br>20: 9,4 ←<br>Serie 93,0<br>Totalt 182,0 |
| 40 shot    |  | 21: 9,1 ↑<br>22: 9,4 ↗<br>23: 10,3* →<br>24: 10,0 ←<br>25: 9,9 ↓<br>26: 10,1 ↓<br>27: 7,0 →<br>28: 10,3* →<br>29: 10,2* →<br>30: 10,3* →<br>Serie 94,0<br>Totalt 276,0 | 40 shot   |
|            |   |  | 31: 9,8 ↘<br>32: 8,9 ↓<br>33: 9,9 →<br>34: 9,7 ↖<br>35: 10,2* ↘<br>36: 10,3* ↗<br>37: 9,1 ←<br>38: 8,9 →<br>39: 9,9 ↑<br>40: 9,3 ←<br>Serie 90,0<br>Totalt 366,0    |
| Umeå skf   |   |  |   |

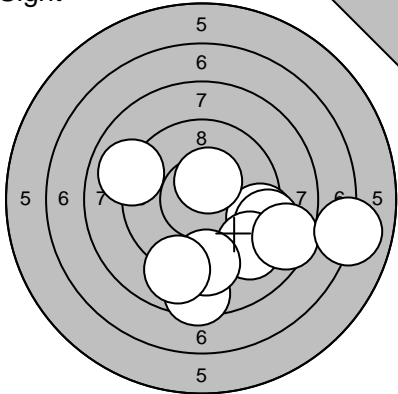
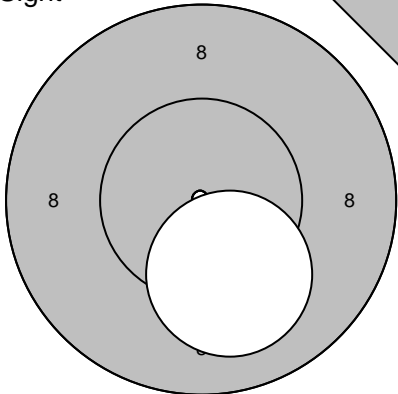
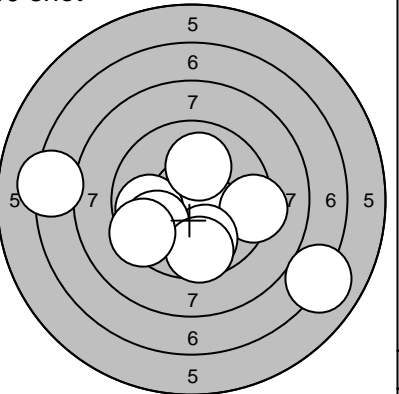
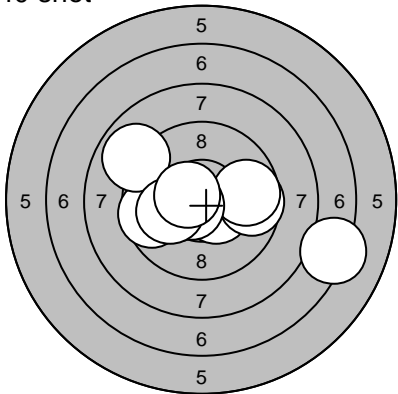
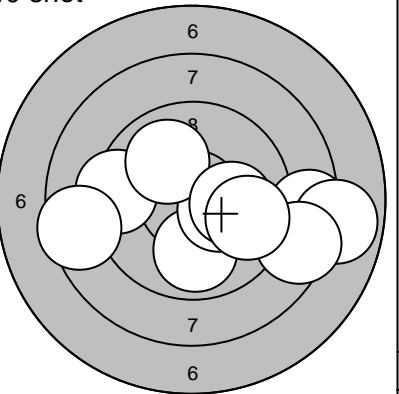
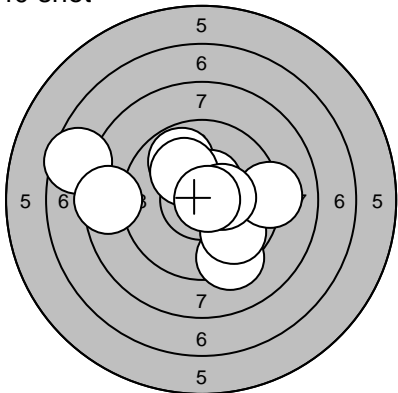
|                 |   |   |   |
|-----------------|---|---|---|
| Skjutlag        | Tavla   | <b>Johanna Martin</b>   |   |
| <b>2</b>        | <b>16</b>   |   |   |
| STPL            | Ramselefors   |   |   |
| 2009-01-17      | Skyttiaden 2009   | Umeå skytteallians  |   |
| Sight           |    | 1: 9,3 →<br>2: 8,5 ↓<br>3: 9,1 ↘<br>4: 9,2 ↘<br>5: 9,3 ↓<br>6: 9,0 ↓<br>7: 8,5 ↘<br>8: 10,4* ↗<br>9: 9,0 ↗<br>10: 7,0 →<br>Serie 87,0<br>Totalt 0,0                   | Sight   |
|                 |   |   | 11: 9,9 ↘<br>12: 8,1 ↘<br>13: 8,9 ←<br>14: 6,2 →<br>15: 9,5 →<br>16: 10,1 ↗<br>17: 8,1 ↘<br>18: 7,0 ↓<br>19: 10,4* ↑<br>20: 5,1 ←<br>Serie 80,0<br>Totalt 0,0   |
| Sight           |   | 21: 10,1 ↓  | 40 shot   |
|                 |   | Serie 10,0<br>Totalt 0,0  |  1: 10,7* →<br>2: 9,3 →<br>3: 7,3 ←<br>4: 9,8 ↓<br>5: 9,8 ←<br>6: 9,8 ←<br>7: 9,6 ↓<br>8: 7,0 ↘<br>9: 9,4 ↘<br>10: 10,1 ↑<br>Serie 88,0<br>Totalt 88,0             |
| 40 shot         |  | 11: 10,2* ←<br>12: 10,4* ↘<br>13: 9,6 →<br>14: 9,7 →<br>15: 9,6 ←<br>16: 10,7* ←<br>17: 9,0 ↗<br>18: 10,1 ←<br>19: 10,6* ↗<br>20: 7,2 →<br>Serie 93,0<br>Totalt 181,0 | 40 shot   |
|                 |   |   |  21: 8,5 →<br>22: 7,9 →<br>23: 9,9 ↓<br>24: 9,4 ←<br>25: 10,3* ↘<br>26: 10,0 ↗<br>27: 10,1 →<br>28: 8,5 ↘<br>29: 9,7 ↘<br>30: 8,5 ←<br>Serie 88,0<br>Totalt 269,0 |
| 40 shot         |  | 31: 9,8 ↗<br>32: 7,6 ←<br>33: 9,3 ↓<br>34: 10,5* ↗<br>35: 9,8 ↓<br>36: 10,1 ↗<br>37: 8,5 ←<br>38: 9,1 →<br>39: 10,4* →<br>40: 10,8* →<br>Serie 91,0<br>Totalt 360,0   |   |
| <b>Umeå skf</b> |   |   |   |

|                      |                    |                      |           |       |
|----------------------|--------------------|----------------------|-----------|-------|
| Skjutlag<br><b>2</b> | Tavla<br><b>17</b> | <b>Sandra Edlund</b> |           |       |
| STPL                 |                    | Umeå                 |           |       |
| 2009-01-17           |                    | Skyttiaden 2009      |           |       |
| Sight                |                    | Umeå skytteallians   |           |       |
|                      | 1: 9,5 ←           |                      | 1: 8,9 ↓  |       |
|                      | 2: 10,1 ↙          |                      | 2: 9,3 ↓  |       |
|                      | 3: 9,7 ↓           |                      | 3: 9,2 ↘  |       |
| Serie                | 28,0               | Serie                | 78,0      |       |
| Totalt               | 0,0                | Totalt               | 78,0      |       |
|                      | 11: 9,2 ←          |                      | 21: 8,7 ↙ |       |
|                      | 12: 9,7 →          |                      | 22: 9,0 ← |       |
|                      | 13: 5,4 ↘          |                      | 23: 9,3 ← |       |
| 14: 8,5 ←            | 24: 9,7 ↗          | 25: 8,7 ←            |           |       |
| 15: 9,0 ↗            | 26: 9,3 ↙          | 27: 10,1 ↘           |           |       |
| 16: 9,8 ←            | 28: 9,0 →          | 29: 7,1 ↓            |           |       |
| 17: 10,1 ↗           | 29: 7,1 ↓          | 30: 6,7 ↗            |           |       |
| 18: 10,3* →          | Serie              | 85,0                 | Serie     | 84,0  |
| 19: 8,2 →            | Totalt             | 163,0                | Totalt    | 247,0 |
| 20: 8,6 →            |                    |                      |           |       |
|                      | 31: 10,4* ↗        |                      |           |       |
|                      | 32: 6,3 →          |                      |           |       |
|                      | 33: 9,1 ↗          |                      |           |       |
| 34: 9,4 ↘            |                    |                      |           |       |
| 35: 10,0 ↓           |                    |                      |           |       |
| 36: 9,6 →            |                    |                      |           |       |
| 37: 6,3 ←            |                    |                      |           |       |
| 38: 6,5 ←            |                    |                      |           |       |
| 39: 9,3 ↗            |                    |                      |           |       |
| 40: 8,1 ↙            |                    |                      |           |       |
| Serie                | 82,0               |                      |           |       |
| Totalt               | 329,0              |                      |           |       |

Umeå skf

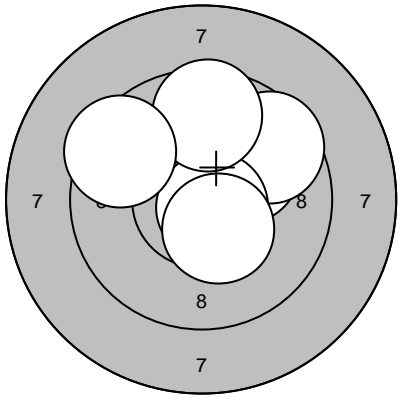
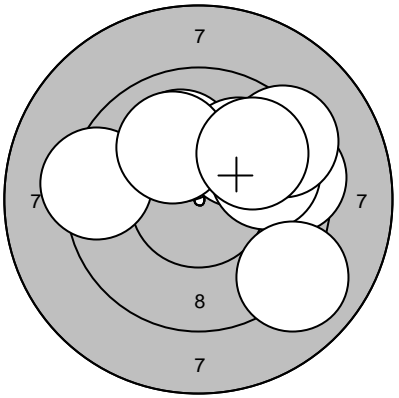
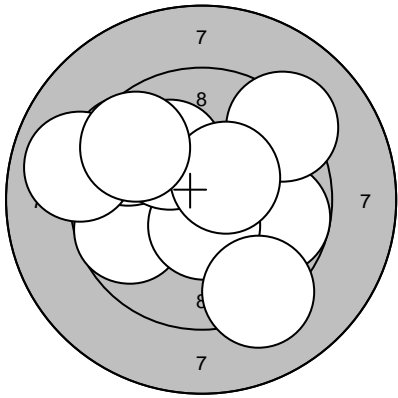
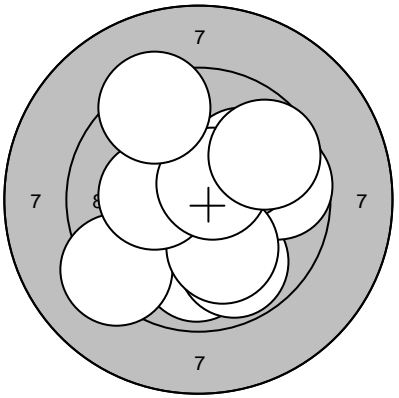
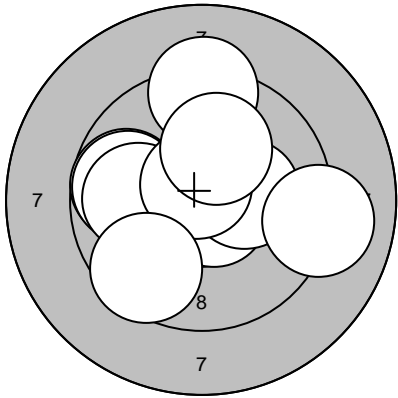

|   |                    |   |              |
|---|--------------------|---|--------------|
| Skjutlag<br><b>2</b>  | Tavla<br><b>21</b> | <b>Erik Lundberg</b>  |              |
| STPL  |                    | Bjurholm-Balsjö   |              |
| 2009-01-17  |                    | Skyttiaden 2009   |              |
| Sight   |                    | Umeå skytteallians  |              |
|    | 1: 9,9 ↗           |   | 1: 9,6 →     |
|   | 2: 10,1 ↗          |   | 2: 9,3 ←     |
|   | 3: 9,6 ↗           |   | 3: 10,1 ↑    |
|   | 4: 10,7* ↘         |   | 4: 10,0 ↗    |
|   | 5: 9,6 ↑           |   | 5: 9,5 →     |
|   | 6: 9,5 ↗           |   | 6: 10,0 ↑    |
|   | 7: 10,4* ↘         |   | 7: 9,8 →     |
|   |                    |   | 8: 9,3 ↗     |
|   |                    |   | 9: 9,8 ↗     |
|   |                    |   | 10: 9,0 ↘    |
|   | Serie 66,0         |   | Serie 93,0   |
|   | Totalt 0,0         |   | Totalt 93,0  |
|   | 11: 9,7 →          |  | 21: 9,9 ↓    |
|   | 12: 9,7 ←          |   | 22: 9,8 ↘    |
|   | 13: 9,6 ↗          |   | 23: 9,7 →    |
|   | 14: 9,0 ←          |   | 24: 10,1 ↗   |
|   | 15: 10,5* ↓        |   | 25: 9,2 ↙    |
|   | 16: 9,2 ↘          |   | 26: 10,1 ↓   |
|   | 17: 9,2 ↗          |   | 27: 10,3* ←  |
|   | 18: 10,1 ↗         |   | 28: 10,6* ↗  |
|   | 19: 10,4* ↗        |   | 29: 9,7 ↗    |
|   | 20: 9,6 ↙          |   | 30: 9,4 ↑    |
|   | Serie 93,0         |   | Serie 94,0   |
|   | Totalt 186,0       |   | Totalt 280,0 |
|  | 31: 9,2 ↑          |   |              |
|   | 32: 10,7* ↘        |   |              |
|   | 33: 9,8 ←          |   |              |
|   | 34: 10,3* →        |   |              |
|   | 35: 9,8 ←          |   |              |
|   | 36: 10,0 ←         |   |              |
|   | 37: 10,7* ↑        |   |              |
|   | 38: 9,6 ↙          |   |              |
|   | 39: 9,0 →          |   |              |
|   | 40: 10,1 ↑         |   |              |
|   | Serie 95,0         |   |              |
|   | Totalt 375,0       |   |              |

Umeå skf

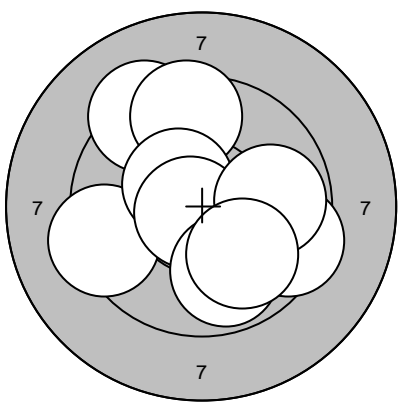
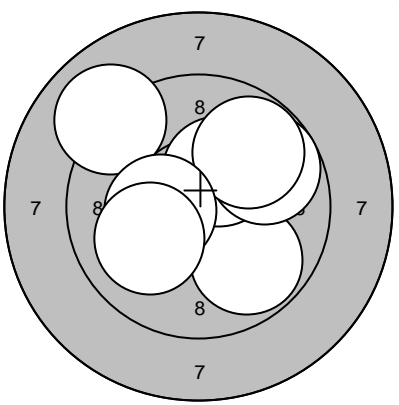
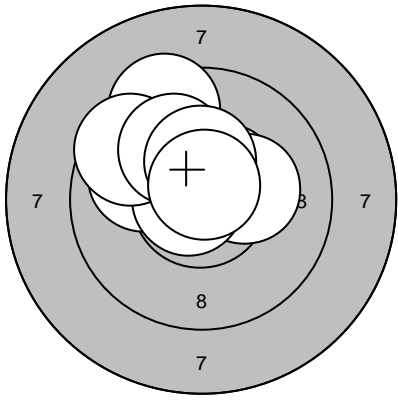
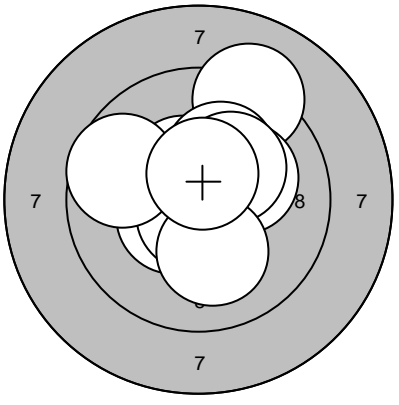
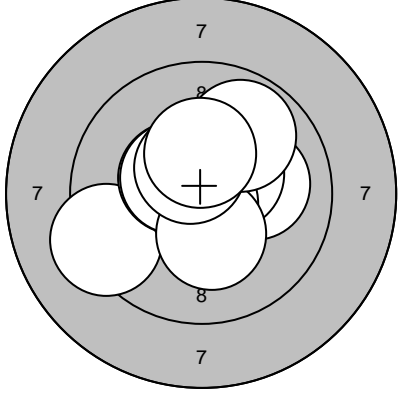
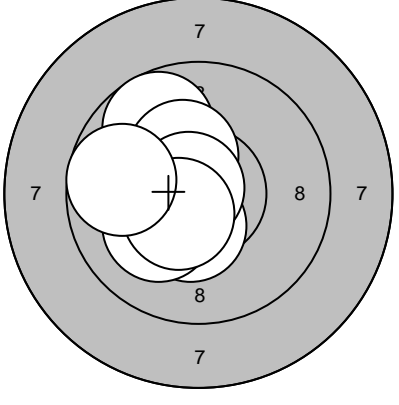
| Skjutlag   | Tavla   | Johannes Lindgren   |   |
|------------|---|---|---|
| 2          | 22  |   |   |
| STPL       | Ramselefors   |   |   |
| 2009-01-17 | Skyttiaden 2009   | Umeå skytteallians  |   |
| Sight      |    | 1: 9,3 ↖<br>2: 9,5 ↑<br>3: 10,7* ←<br>4: 9,3 ←<br>5: 9,5 →<br>6: 10,4* ↗<br>7: 10,7* ↖<br>8: 9,8 ↓<br>9: 9,9 →<br>10: 9,9 ↓<br>Serie 93,0<br>Totalt 0,0                     | Sight   |
|            |   |   | 11: 9,8 ↓<br>12: 10,3* ↗<br>13: 9,8 ↗<br>14: 9,8 ↗<br>15: 9,0 ↖<br>16: 10,3* ←<br>17: 10,0 ↖<br>Serie 66,0<br>Totalt 0,0  |
| 40 shot    |   | 1: 10,4* ↖<br>2: 10,5* ↗<br>3: 10,2* →<br>4: 10,0 ←<br>5: 10,8* ←<br>6: 9,4 ↑<br>7: 9,6 ↑<br>8: 10,1 ↑<br>9: 10,3* ↑<br>10: 10,7* ↑<br>Serie 98,0<br>Totalt 98,0            | 40 shot    |
|            |   |   | 11: 10,4* ↖<br>12: 9,2 ↗<br>13: 10,5* ↖<br>14: 10,2* ↗<br>15: 10,7* ↓<br>16: 10,2* ↗<br>17: 9,7 ←<br>18: 10,2* ↗<br>19: 10,1 ↓<br>20: 10,5* ↑<br>Serie 98,0<br>Totalt 196,0 |
| 40 shot    |  | 21: 9,3 ←<br>22: 10,1 →<br>23: 10,4* ↗<br>24: 10,5* ↖<br>25: 10,8* ↓<br>26: 10,5* ↖<br>27: 10,3* ↓<br>28: 10,5* ↑<br>29: 9,8 ↗<br>30: 10,3* ↑<br>Serie 98,0<br>Totalt 294,0 | 40 shot   |
|            |   |   | 31: 9,7 ↖<br>32: 10,7* ←<br>33: 10,3* ←<br>34: 10,2* ←<br>35: 10,4* ↓<br>36: 10,3* ↖<br>37: 10,8* ↖<br>38: 10,1 ↖<br>39: 10,5* ↖<br>40: 9,7 ←<br>Serie 98,0<br>Totalt 392,0 |
| Umeå skf   |   |   |   |

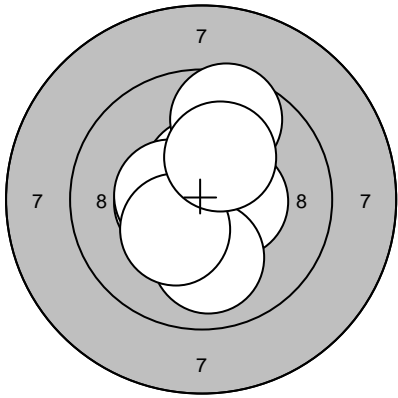
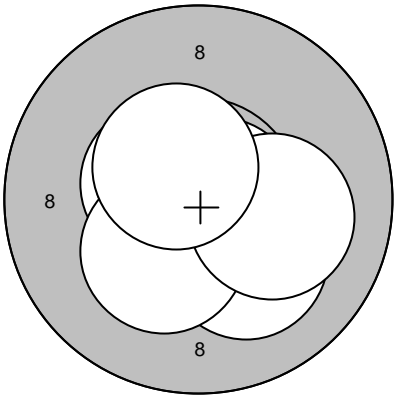
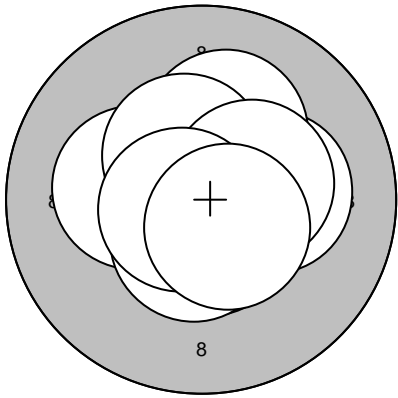
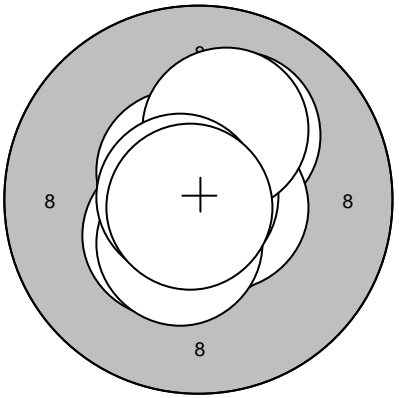
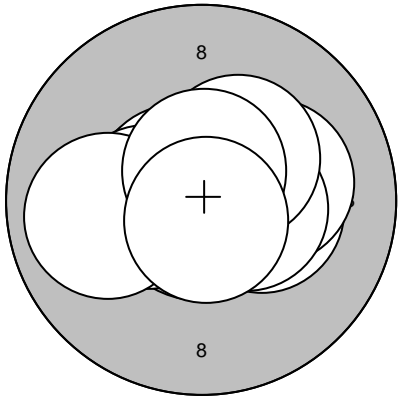
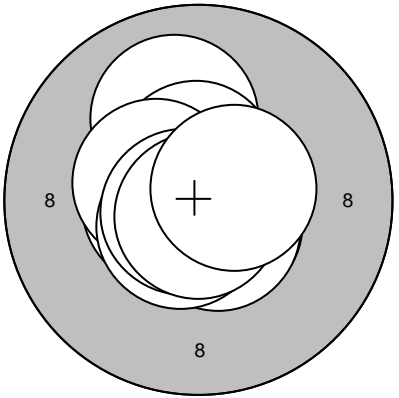
| Skjutlag        | Tavla   |  |  |
|-----------------|---|--|--|
| <b>2</b>        | <b>23</b>   | <b>Linnea Borg</b>   |  |
| STPL            | Vännäs  |  |  |
| 2009-01-17      | Skyttiaden 2009   | Umeå skytteallians   |  |
| Sight           |    | 1: 10,5* ←<br>2: 10,8* ↓<br>3: 10,5* ↑<br>4: 10,7* ←<br>5: 10,4* ←<br>6: 10,4* →<br>7: 10,0 ↓<br>8: 10,3* ↓<br>9: 9,6 ↑<br>10: 10,2* ↑<br>Serie 99,0<br>Totalt 0,0             | Sight    |
|                 |   |  | 11: 10,5* ←<br>12: 10,6* ↗<br>13: 10,2* ↓<br>14: 10,8* ←<br>15: 10,7* →<br>16: 10,3* ↓<br>17: 10,1 →<br>18: 10,5* ↗<br>Serie 80,0<br>Totalt 0,0                                  |
| 40 shot         |   | 1: 10,2* →<br>2: 10,7* ↓<br>3: 10,2* ↑<br>4: 10,2* ←<br>5: 10,5* ↑<br>6: 10,6* ↓<br>7: 10,5* ↓<br>8: 10,4* →<br>9: 10,7* ←<br>10: 10,5* ↓<br>Serie 100,0<br>Totalt 100,0       | 40 shot   |
|                 |   |  | 11: 10,4* ↙<br>12: 10,1 ↗<br>13: 10,7* ↓<br>14: 10,6* ↗<br>15: 10,6* →<br>16: 10,9* ↗<br>17: 10,2* ↑<br>18: 10,4* ↓<br>19: 10,7* ←<br>20: 10,8* ↙<br>Serie 100,0<br>Totalt 200,0 |
| 40 shot         |  | 21: 10,3* →<br>22: 10,6* ←<br>23: 10,2* →<br>24: 10,7* ←<br>25: 10,5* →<br>26: 10,4* ←<br>27: 10,3* ↗<br>28: 9,9 ←<br>29: 10,6* ↑<br>30: 10,7* ↓<br>Serie 99,0<br>Totalt 299,0 | 40 shot    |
|                 |   |  | 31: 10,6* ↓<br>32: 10,6* ←<br>33: 10,0 ↑<br>34: 10,6* ↑<br>35: 10,5* ↖<br>36: 10,6* ↓<br>37: 10,6* ↓<br>38: 10,7* ↖<br>39: 10,8* ↓<br>40: 10,6* →<br>Serie 100,0<br>Totalt 399,0 |
| <b>Umeå skf</b> |   |  |  |

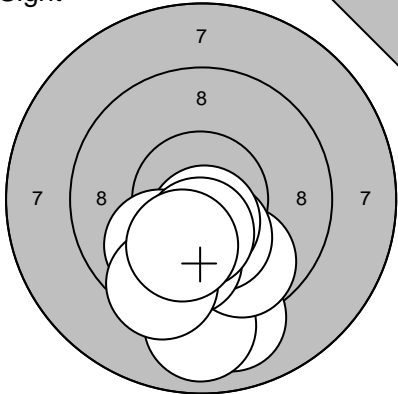
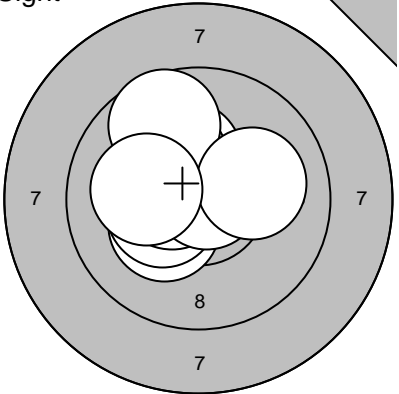
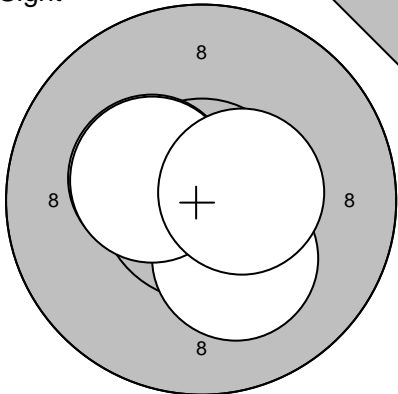
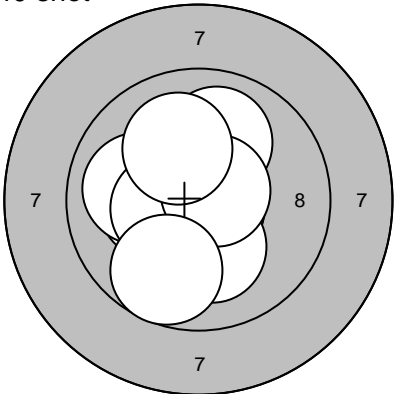
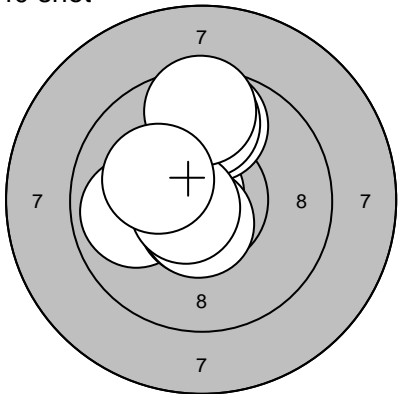
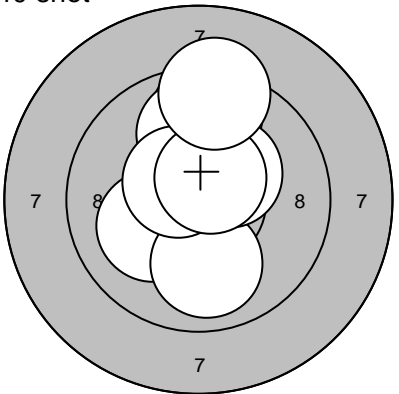
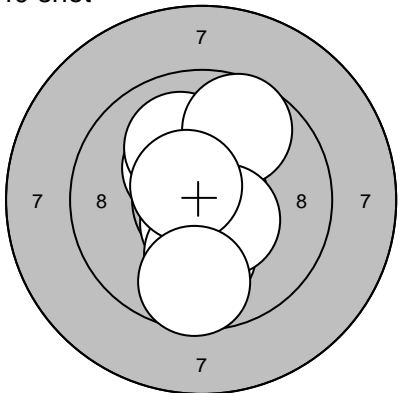
|  |   |   |  |
|--|---|---|--|
| Skjutlag<br><b>2</b>   | Tavla<br><b>25</b>  | <b>Saul Johansson</b>   |  |
| STPL   |   | Bjurholm-Balsjö   |  |
| 2009-01-17   |   | Skyttiaden 2009   | Umeå skytteallians   |
| Sight<br>     | 1: 9,0 ↓<br>2: 8,9 ↓<br>3: 9,7 ↓<br>4: 10,3* ↓<br>5: 10,6* ↓<br>6: 10,0 ↓<br>7: 9,9 ↓<br>8: 9,5 ↓<br>9: 10,4* ↓<br>10: 10,1 ↓<br>Serie 94,0<br>Totalt 0,0                 | Sight<br>     | 11: 10,3* ↙<br>12: 10,3* ←<br>13: 10,5* ←<br>14: 10,4* ↗<br>15: 10,3* ↑<br>16: 10,2* ↗<br>17: 10,8* ↗<br>18: 9,7 ↑<br>19: 10,1 →<br>20: 10,1 ←<br>Serie 99,0<br>Totalt 0,0 |
| Sight<br>    | 21: 10,4* ↙<br>22: 10,2* ↓<br>23: 10,4* ↖<br>24: 10,5* →<br>Serie 40,0<br>Totalt 0,0  | 40 shot<br>  | 1: 10,7* ↓<br>2: 10,2* ↓<br>3: 10,0 ↑<br>4: 10,2* ←<br>5: 10,3* ↗<br>6: 10,0 ←<br>7: 10,4* ←<br>8: 10,6* ↗<br>9: 10,1 ↑<br>10: 9,7 ↓<br>Serie 99,0<br>Totalt 99,0          |
| 40 shot<br> | 11: 10,7* ↖<br>12: 9,9 ←<br>13: 10,4* ↗<br>14: 9,8 ↑<br>15: 10,6* ↓<br>16: 9,7 ↑<br>17: 10,6* ↓<br>18: 10,7* ↖<br>19: 9,5 ↑<br>20: 10,2* ↖<br>Serie 96,0<br>Totalt 195,0  | 40 shot<br> | 21: 10,1 ↖<br>22: 9,6 ↑<br>23: 9,9 ↓<br>24: 10,5* ↑<br>25: 9,9 ↑<br>26: 10,4* ↗<br>27: 10,3* ↗<br>28: 10,5* ↖<br>29: 10,5* ↗<br>30: 9,3 ↑<br>Serie 96,0<br>Totalt 291,0    |
| 40 shot<br> | 31: 10,8* ↓<br>32: 10,3* ↗<br>33: 10,1 ↑<br>34: 10,1 ↑<br>35: 10,6* ↓<br>36: 9,7 ↗<br>37: 10,1 ↓<br>38: 10,4* ↓<br>39: 10,6* ↗<br>40: 9,7 ↓<br>Serie 98,0<br>Totalt 389,0 |   |  |
| <b>Umeå skf</b>  |   |   |  |

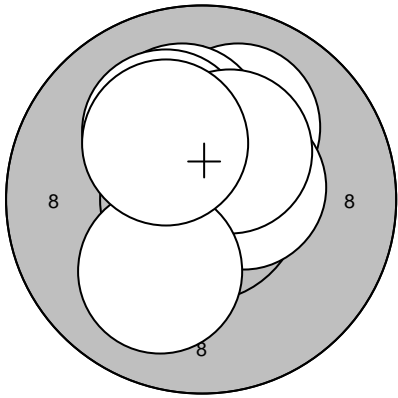
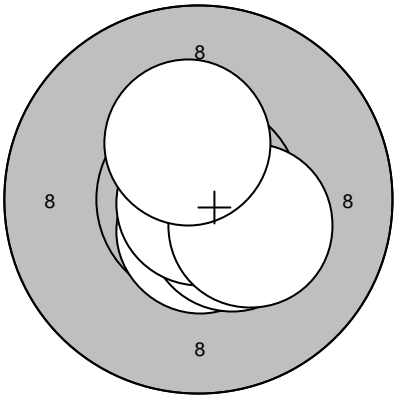
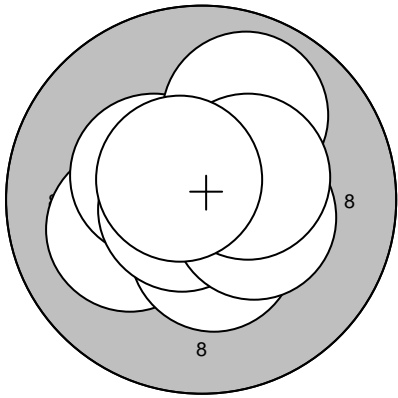
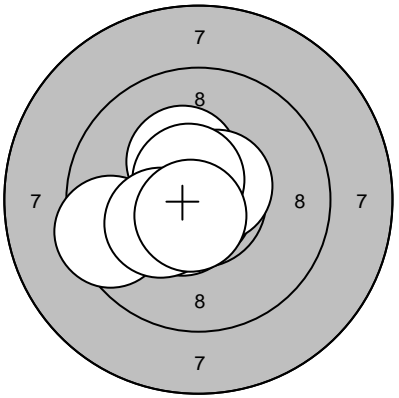
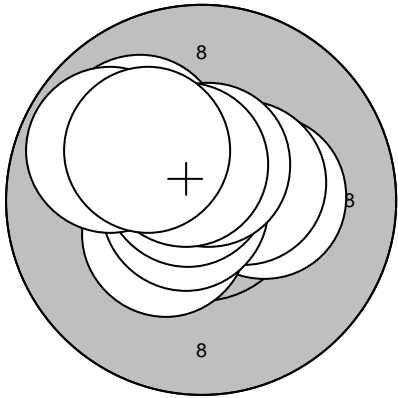
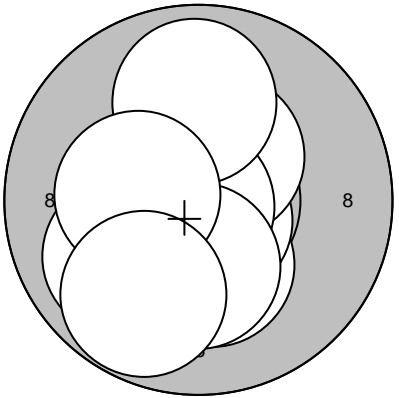
|   |                    |  |              |
|---|--------------------|--|--------------|
| Skjutlag<br><b>2</b>  | Tavla<br><b>27</b> | <b>Oskar Nilsson</b>   |              |
| STPL  |                    | Bjurholm-Balsjö  |              |
| 2009-01-17  |                    | Skyttiaden 2009  |              |
| Sight   |                    | Sight  |              |
|    | 1: 10,1 ↗          |    | 11: 10,6* ↓  |
|   | 2: 10,7* ↗         |  | 12: 10,5* ↘  |
|   | 3: 10,4* ↑         |  | 13: 10,9* ↓  |
|   | 4: 10,1 ↑          |  | 14: 10,3* ↘  |
|   | 5: 10,5* →         |  | 15: 10,3* ↑  |
|   | 6: 10,1 ↑          |  |              |
|   | 7: 10,1 ↑          |  |              |
|   | 8: 10,4* ↗         |  |              |
|   | 9: 10,1 ↓          |  |              |
|   | 10: 10,2* ↗        |  |              |
|   | Serie 100,0        |  | Serie 50,0   |
|   | Totalt 0,0         |  | Totalt 0,0   |
| 40 shot   |                    | 40 shot  |              |
|   | 1: 10,1 ←          |   | 11: 10,5* ↘  |
|   | 2: 10,5* ↗         |  | 12: 10,8* ↓  |
|   | 3: 10,4* ↖         |  | 13: 10,6* ↑  |
|   | 4: 10,4* ↓         |  | 14: 10,3* ↑  |
|   | 5: 10,8* ↗         |  | 15: 10,6* ↘  |
|   | 6: 10,7* ↖         |  | 16: 10,6* ↗  |
|   | 7: 10,3* →         |  | 17: 10,6* ↖  |
|   | 8: 9,9 ↑           |  | 18: 9,5 ←    |
|   | 9: 10,4* ↗         |  | 19: 10,2* ↖  |
|   | 10: 10,6* ↖        |  | 20: 10,7* ↓  |
|   | Serie 99,0         |  | Serie 99,0   |
|   | Totalt 99,0        |  | Totalt 198,0 |
| 40 shot   |                    | 40 shot  |              |
|  | 21: 10,3* →        |  | 31: 10,2* ↓  |
|   | 22: 10,0 ↖         |  | 32: 10,8* ↓  |
|   | 23: 10,5* →        |  | 33: 10,7* ↘  |
|   | 24: 10,4* ↖        |  | 34: 10,4* ↑  |
|   | 25: 10,8* ↖        |  | 35: 10,9* ↘  |
|   | 26: 10,7* ↖        |  | 36: 10,0 ↖   |
|   | 27: 9,8 ↖          |  | 37: 10,2* ↓  |
|   | 28: 10,6* ↑        |  | 38: 9,9 ↑    |
|   | 29: 10,5* ↑        |  | 39: 10,3* ←  |
|   | 30: 10,2* ↖        |  | 40: 9,8 ↘    |
|   | Serie 99,0         |  | Serie 98,0   |
|   | Totalt 297,0       |  | Totalt 395,0 |
| <b>Umeå skf</b>   |                    |  |              |

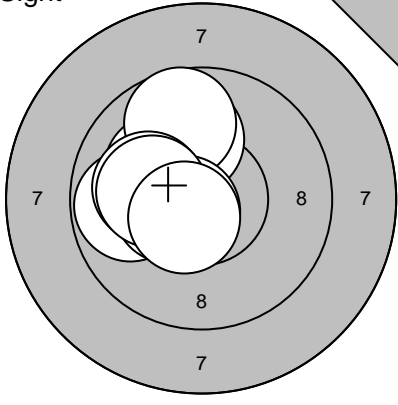
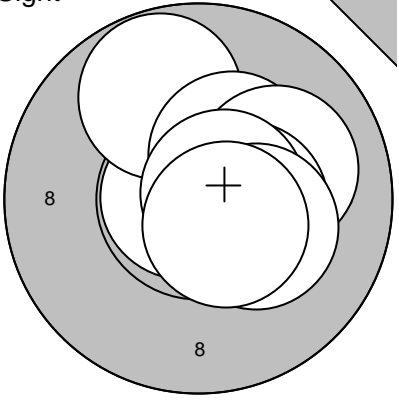
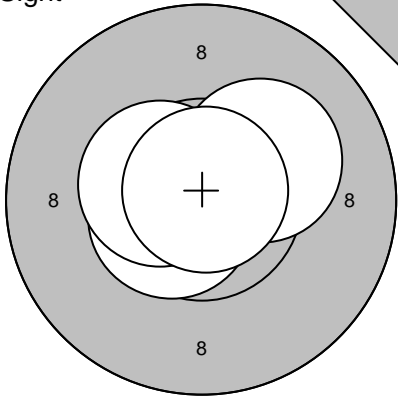
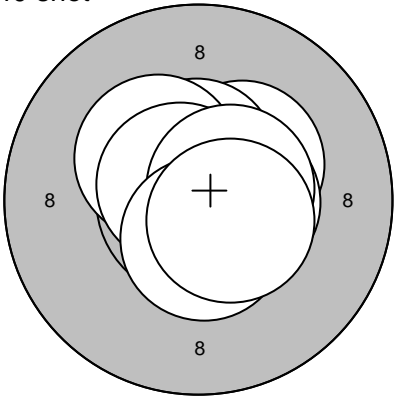
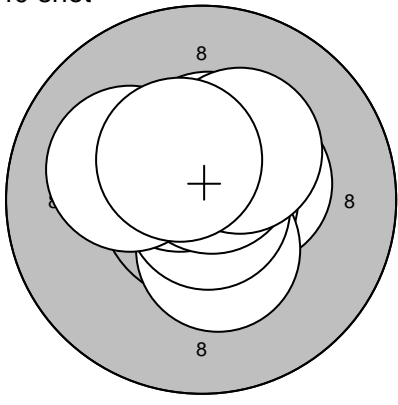
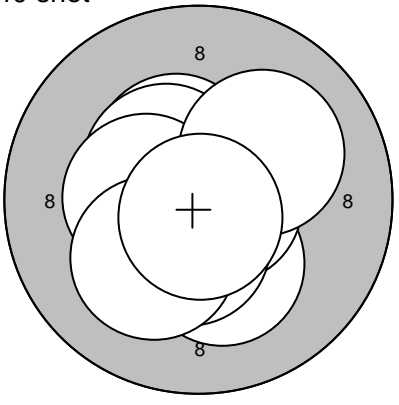
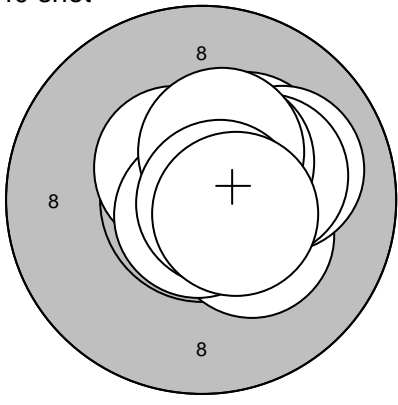
|   |   |  |   |
|---|---|--|---|
| Skjutlag<br><b>2</b>  | Tavla<br><b>29</b>  | <b>John Enardsson</b>  |   |
| STPL  |   | Bjurholm-Balsjö  |   |
| 2009-01-17  |   | Skyttiaden 2009  |   |
| Sight   |   | Umeå skytteallians   |   |
|    | 1: 10,4* ↖<br>2: 10,2* ↗<br>3: 10,0 ↑<br>4: 9,7 ↑<br>5: 9,8 ←<br>6: 10,4* ←<br>7: 10,6* ↘<br>8: 10,1 ←<br>9: 10,2* ←<br>10: 10,6* ↘               |    | 11: 10,9* ↑<br>12: 10,8* ←<br>13: 9,8 ↑<br>14: 10,5* →<br>15: 10,4* ↗<br>16: 10,1 →<br>17: 10,4* →<br>18: 10,7* →<br>19: 10,3* ↘<br>20: 10,6* ↘   |
|   | Serie 98,0<br>Totalt 0,0  |  | Serie 99,0<br>Totalt 0,0  |
|   | 21: 10,6* ↖<br>22: 10,5* ←<br>23: 10,2* →<br>24: 10,8* ↑  |   | 1: 10,6* ↑<br>2: 10,9* →<br>3: 10,3* ↗<br>4: 10,5* ↑<br>5: 10,3* ↗<br>6: 10,7* ↗<br>7: 10,5* →<br>8: 10,6* →<br>9: 10,5* ↓<br>10: 10,5* ↘         |
|   | Serie 40,0<br>Totalt 0,0  |  | Serie 100,0<br>Totalt 100,0   |
|  | 11: 10,4* →<br>12: 10,8* →<br>13: 10,4* ↓<br>14: 10,8* ↓<br>15: 10,5* ↗<br>16: 10,5* ↑<br>17: 10,6* ↑<br>18: 10,3* ↗<br>19: 10,1 ↖<br>20: 10,5* ↗ |  | 21: 10,2* ↓<br>22: 10,6* ↓<br>23: 10,4* ↑<br>24: 10,7* →<br>25: 10,5* ↗<br>26: 10,5* ↓<br>27: 10,4* ←<br>28: 10,2* ↓<br>29: 10,1 ↗<br>30: 10,8* ↓ |
|   | Serie 100,0<br>Totalt 200,0   |  | Serie 100,0<br>Totalt 300,0   |
|  | 31: 10,3* ↘<br>32: 10,3* ↗<br>33: 10,5* ↗<br>34: 10,8* ↓<br>35: 10,0 →<br>36: 10,2* →<br>37: 10,4* ↗<br>38: 10,4* ↑<br>39: 10,7* →<br>40: 10,5* → |  |   |
|   | Serie 100,0<br>Totalt 400,0   |  |   |

Umeå skf

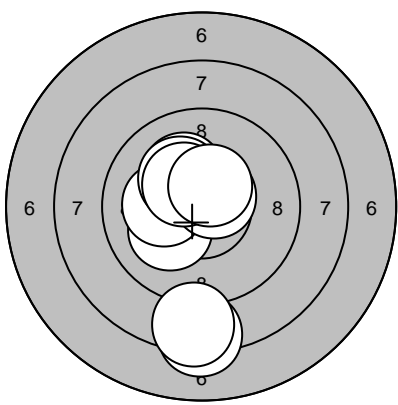
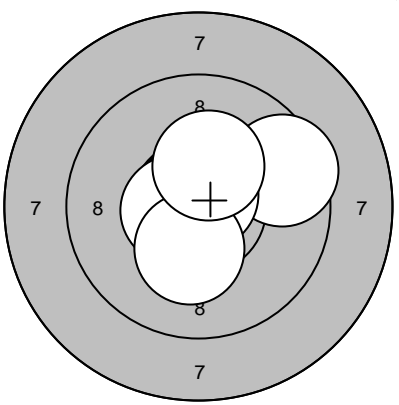
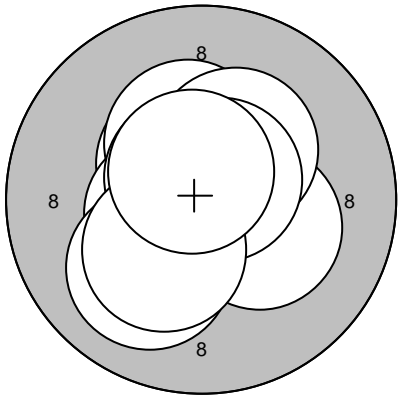
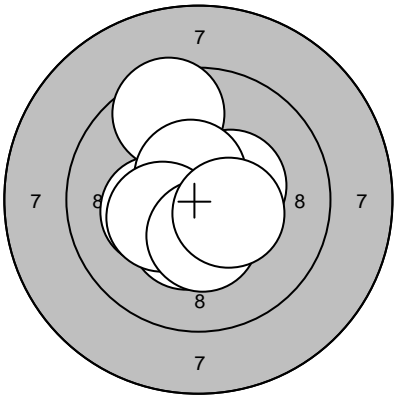
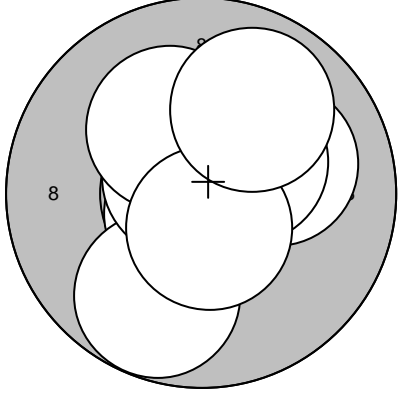
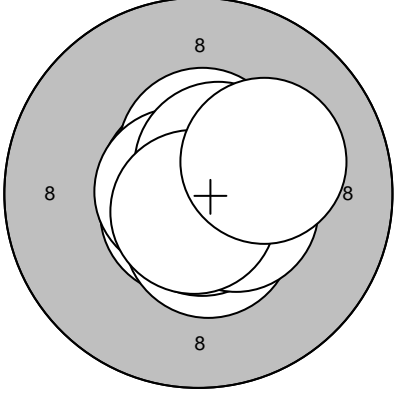
| Skjutlag   | Tavla   | Robin Bahlenberg  |   |
|------------|---|---|---|
| 2          | 33  |   |   |
| STPL       | Bjurholm-Balsjö   |   |   |
| 2009-01-17 | Skyttiaden 2009   | Umeå skytteallians  |   |
| Sight      |    | 1: 8,3 ↓<br>2: 8,4 ↓<br>3: 10,8* ↖<br>4: 10,1 ↙<br>5: 10,2* ←<br>6: 10,2* ↗<br>7: 10,2* ↗<br>8: 10,6* ↗<br>9: 10,4* ↗<br>10: 10,5* ↗<br>Serie 96,0<br>Totalt 0,0            | Sight   |
|            |   |   | 11: 10,8* ↖<br>12: 9,5 →<br>13: 10,8* ↑<br>14: 10,6* ←<br>15: 10,3* ↓<br>16: 10,3* ↑<br>Serie 59,0<br>Totalt 0,0  |
| 40 shot    |   | 1: 10,5* ↖<br>2: 10,3* ↑<br>3: 10,3* →<br>4: 10,5* ←<br>5: 10,7* ↗<br>6: 10,0 ↙<br>7: 10,3* ↗<br>8: 10,7* ↗<br>9: 10,3* ↙<br>10: 10,6* ↗<br>Serie 100,0<br>Totalt 100,0     | 40 shot    |
|            |   |   | 11: 10,6* ↓<br>12: 9,5 ↑<br>13: 10,8* →<br>14: 10,3* ↓<br>15: 10,4* →<br>16: 10,2* ←<br>17: 10,6* ↑<br>18: 10,3* ←<br>19: 10,4* ↓<br>20: 10,4* →<br>Serie 99,0<br>Totalt 199,0    |
| 40 shot    |  | 21: 10,7* ↙<br>22: 10,1 →<br>23: 10,8* ↑<br>24: 9,8 ↓<br>25: 10,4* ↗<br>26: 10,7* ↗<br>27: 10,4* ↗<br>28: 10,2* ↗<br>29: 10,6* ↓<br>30: 9,9 ↗<br>Serie 98,0<br>Totalt 297,0 | 40 shot   |
|            |   |   | 31: 10,7* ↙<br>32: 10,8* ↘<br>33: 10,5* ↑<br>34: 10,5* ↓<br>35: 10,7* ↓<br>36: 10,7* ←<br>37: 10,5* →<br>38: 10,6* ↗<br>39: 10,7* ↓<br>40: 10,2* →<br>Serie 100,0<br>Totalt 397,0 |
| Umeå skf   |   |   |   |

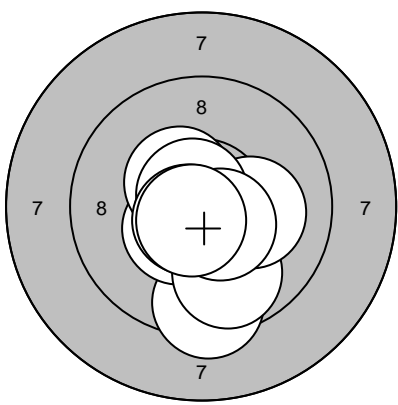
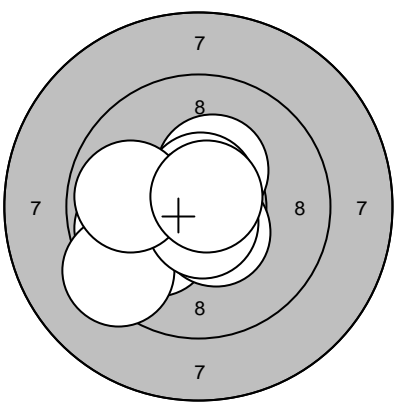
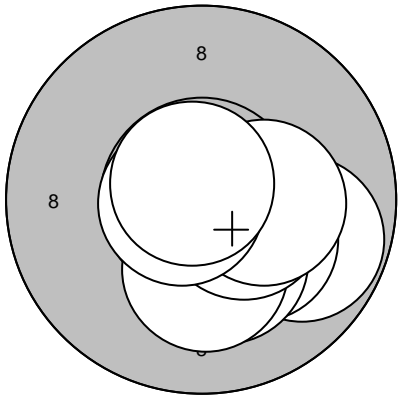
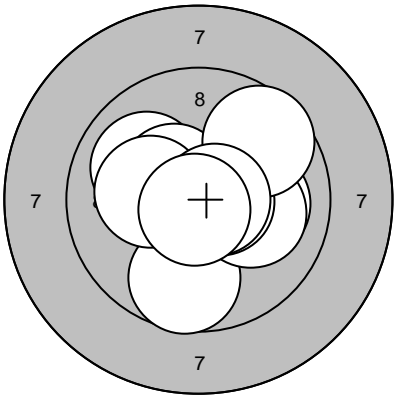
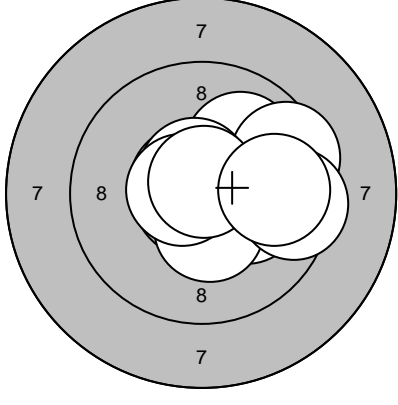
| Skjutlag   | Tavla   | Tobias Karlsson Bjerkevall   |   |
|------------|---|--|---|
| STPL       | Bastuträsk  |  |   |
| 2009-01-17 | Skyttiaden 2009   | Umeå skytteallians   |   |
| Sight      |    | 1: 9,4 ↓<br>2: 10,4* ↙<br>3: 9,8 ↓<br>4: 10,4* ↗<br>5: 10,2* →<br>6: 10,7* ↙<br>7: 10,7* ↗<br>8: 10,7* ↙<br>9: 10,5* ↓<br>10: 10,7* ↙<br>Serie 98,0<br>Totalt 0,0              | 40 shot<br>   |
|            |   |  | 1: 10,1 ↙<br>2: 10,3* ↗<br>3: 10,5* ↘<br>4: 10,7* ↗<br>5: 9,8 ↙<br>6: 9,3 ↙<br>7: 10,9* ↙<br>8: 10,7* ↘<br>9: 9,9 ↙<br>10: 10,8* ↗<br>Serie 97,0<br>Totalt 97,0           |
| 40 shot    |   | 11: 9,8 →<br>12: 10,4* ↘<br>13: 10,2* ↘<br>14: 10,2* ↘<br>15: 10,6* ↘<br>16: 10,2* ↘<br>17: 10,4* →<br>18: 10,3* →<br>19: 10,7* ↙<br>20: 10,8* ↗<br>Serie 99,0<br>Totalt 196,0 | 40 shot<br>  |
|            |   |  | 21: 9,7 ↘<br>22: 10,0 ↖<br>23: 10,0 →<br>24: 10,5* ↗<br>25: 10,1 →<br>26: 10,2* ↙<br>27: 10,6* →<br>28: 9,6 ↗<br>29: 10,7* →<br>30: 10,8* ↘<br>Serie 98,0<br>Totalt 294,0 |
| 40 shot    |  | 31: 10,2* →<br>32: 10,7* ↖<br>33: 10,0 ↗<br>34: 9,5 →<br>35: 10,6* ↗<br>36: 10,4* ↘<br>37: 9,5 →<br>38: 10,7* ↙<br>39: 10,8* ↗<br>40: 9,8 →<br>Serie 97,0<br>Totalt 391,0      |   |

Umeå skf

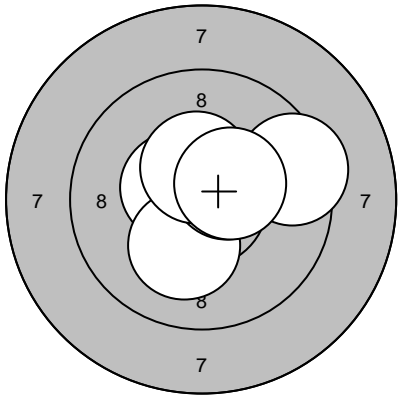
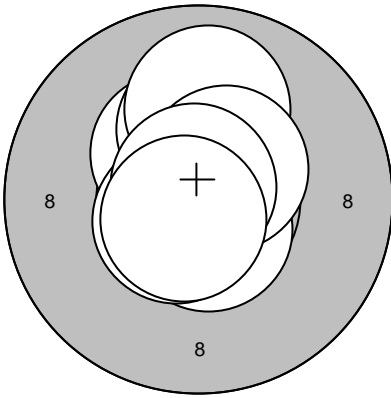
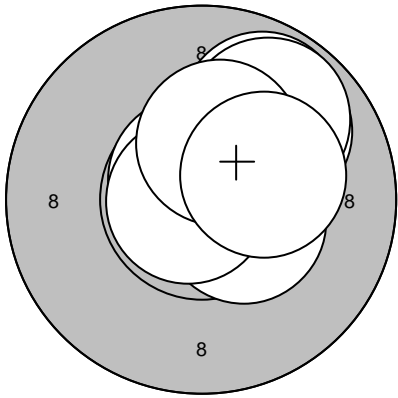
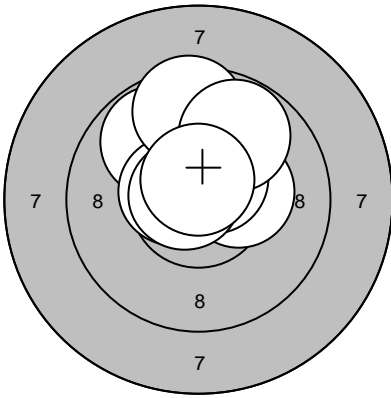
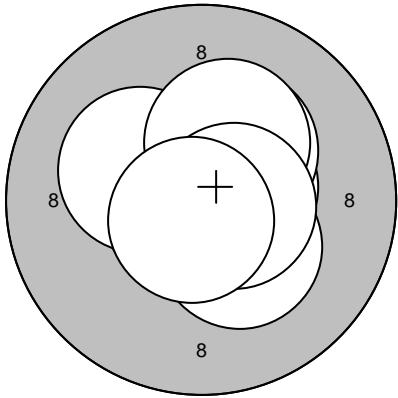

|  |                    |  |                    |
|--|--------------------|--|--------------------|
| Skjutlag<br><b>2</b>   | Tavla<br><b>37</b> | <b>Oskar Jacobsson</b>   |                    |
| STPL   |                    | Ramselefors  |                    |
| 2009-01-17   |                    | Skyttiaden 2009  | Umeå skytteallians |
| Sight<br>     | 1: 10,5* ←         | 40 shot<br>  | 1: 10,4* ↖         |
|  | 2: 9,4 →           |  | 2: 10,5* ↑         |
|  | 3: 10,2* ↓         |  | 3: 10,2* ↑         |
|  | 4: 10,5* →         |  | 4: 10,0 ↑          |
|  | 5: 10,4* ↑         |  | 5: 10,6* ↓         |
|  | 6: 10,4* →         |  | 6: 10,5* ↗         |
|  | Serie 59,0         |  | Serie 100,0        |
|  | Totalt 0,0         |  | Totalt 100,0       |
| 40 shot<br>  | 11: 10,6* ↗        | 40 shot<br> | 21: 10,4* ↑        |
|  | 12: 10,7* ↖        |  | 22: 9,8 ↖          |
|  | 13: 10,3* ↗        |  | 23: 10,2* ↗        |
|  | 14: 9,9 ↗          |  | 24: 10,6* ←        |
|  | 15: 10,4* →        |  | 25: 10,3* →        |
|  | 16: 9,8 ↗          |  | 26: 10,5* ↗        |
|  | 17: 10,8* ←        |  | 27: 10,7* ←        |
|  | 18: 9,8 ↗          |  | 28: 9,5 ↑          |
|  | 19: 10,3* ↑        |  | 29: 9,8 ↗          |
|  | 20: 10,2* →        |  | 30: 10,6* ↑        |
|  | Serie 97,0         |  | Serie 97,0         |
|  | Totalt 197,0       |  | Totalt 294,0       |
| 40 shot<br> | 31: 10,5* ↑        |  |                    |
|  | 32: 10,5* →        |  |                    |
|  | 33: 10,7* →        |  |                    |
|  | 34: 10,6* ↑        |  |                    |
|  | 35: 10,3* ↗        |  |                    |
|  | 36: 10,2* ←        |  |                    |
|  | 37: 10,3* ↘        |  |                    |
|  | 38: 10,3* ↗        |  |                    |
|  | 39: 10,6* →        |  |                    |
|  | 40: 10,7* ↓        |  |                    |
|  | Serie 100,0        |  |                    |
|  | Totalt 394,0       |  |                    |

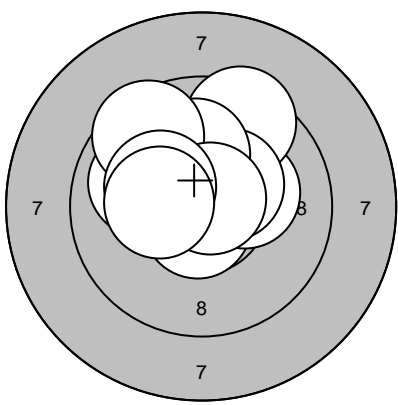
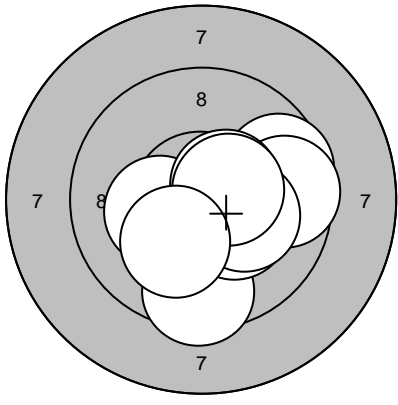
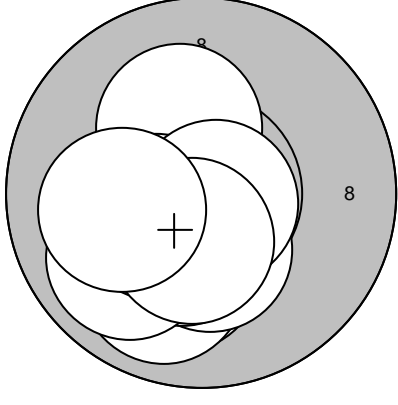
|                      |   |  |                    |
|----------------------|---|--|--------------------|
| Skjutlag<br><b>2</b> | Tavla<br><b>38</b>  | <b>Hanna Lundin</b>  |                    |
| STPL                 |   | Umeå   |                    |
| 2009-01-17           |   | Skyttiaden 2009  | Umeå skytteallians |
| Sight                |    | 1: 10,7* ↓<br>2: 10,2* →<br>3: 9,5 ↑<br>4: 10,4* →<br>5: 10,1 ↑<br>6: 10,0 ←<br>7: 9,6 ↑<br>8: 10,8* →<br>9: 10,2* ←<br>10: 10,3* ←          | Sight              |
|                      |   | Serie 98,0   | 11: 9,9 ↗          |
|                      |   | Totalt 0,0   | 12: 10,7* ↑        |
|                      |   |  | 13: 10,7* ↘        |
|                      |   |  | Serie 29,0         |
|                      |   |  | Totalt 0,0         |
| 40 shot              |   | 1: 9,6 →<br>2: 9,5 ↓<br>3: 9,6 →<br>4: 10,5* →<br>5: 10,3* ↘<br>6: 10,3* ←<br>7: 10,5* →<br>8: 10,2* →<br>9: 10,5* →<br>10: 10,2* ↘          | 40 shot            |
|                      |   | Serie 97,0   | 11: 10,8* ←        |
|                      |   | Totalt 97,0  | 12: 10,4* ←        |
|                      |   |  | 13: 10,6* ↓        |
|                      |   |  | 14: 10,1 ↘         |
|                      |   |  | 15: 9,9 ↘          |
|                      |   |  | 16: 9,6 ←          |
|                      |   |  | 17: 10,4* ↘        |
|                      |   |  | 18: 10,4* ↘        |
|                      |   |  | 19: 10,7* ←        |
|                      |   |  | 20: 9,8 ↘          |
|                      |   |  | Serie 97,0         |
|                      |   |  | Totalt 194,0       |
| 40 shot              |  | 21: 10,1 ↓<br>22: 9,9 ↓<br>23: 10,3* ↓<br>24: 10,4* ↓<br>25: 9,9 ←<br>26: 10,2* ↑<br>27: 10,4* ←<br>28: 10,8* →<br>29: 10,4* ↓<br>30: 10,1 ← | 40 shot            |
|                      |   | Serie 98,0   | 31: 10,6* ↗        |
|                      |   | Totalt 292,0   | 32: 10,2* ←        |
|                      |   |  | 33: 10,3* ←        |
|                      |   |  | 34: 10,1 ↗         |
|                      |   |  | 35: 10,2* ↗        |
|                      |   |  | 36: 10,8* ↗        |
|                      |   |  | 37: 10,6* ←        |
|                      |   |  | 38: 10,6* ↗        |
|                      |   |  | 39: 10,6* ↑        |
|                      |   |  | 40: 10,4* ↑        |
|                      |   |  | Serie 100,0        |
|                      |   |  | Totalt 392,0       |
| <b>Umeå skf</b>      |   |  |                    |

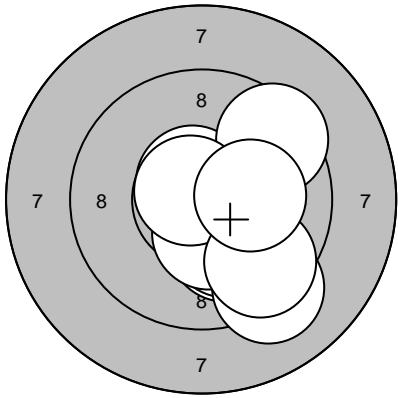
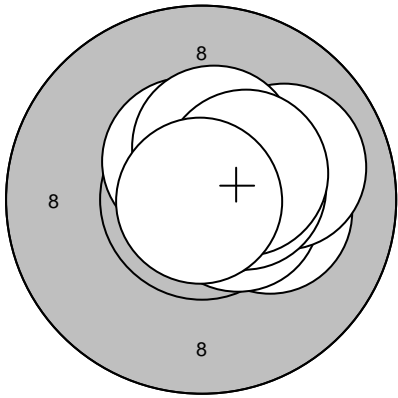
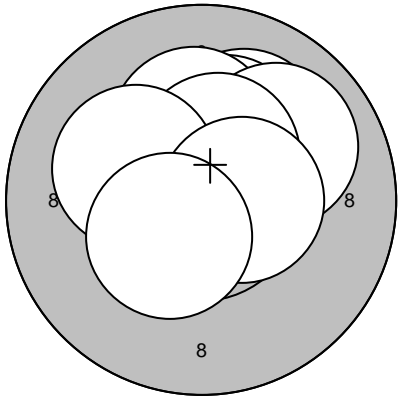
| Skjutlag   | Tavla   | Johanna Nilsson   |   |
|------------|---|---|---|
| STPL       | Ramselefors   |   |   |
| 2009-01-17 | Skyttiaden 2009   | Umeå skytteallians  |   |
| Sight      |    | 1: 10,1 ↓<br>2: 10,8* ↓<br>3: 10,1 ↓<br>4: 10,7* ↑<br>5: 9,5 →<br>6: 10,4* ↓<br>7: 10,7* ↑<br>8: 9,2 ↓<br>9: 9,6 ↓<br>10: 10,2* →<br>Serie 97,0<br>Totalt 0,0                   | Sight   |
|            |   |   | 11: 10,6* ↓<br>12: 10,4* ↓<br>Serie 20,0<br>Totalt 0,0  |
| 40 shot    |   | 1: 10,2* →<br>2: 10,2* →<br>3: 10,5* ↑<br>4: 10,5* →<br>5: 10,0 →<br>6: 10,8* →<br>7: 10,5* →<br>8: 10,4* ↑<br>9: 10,4* →<br>10: 10,9* ↙<br>Serie 100,0<br>Totalt 100,0         | 40 shot   |
|            |   |   | 11: 10,5* ↓<br>12: 10,7* ↘<br>13: 10,6* →<br>14: 10,3* ↓<br>15: 10,2* ↗<br>16: 9,9 ↗<br>17: 10,6* ↓<br>18: 10,5* →<br>19: 10,2* ↘<br>20: 10,1 ↓<br>Serie 99,0<br>Totalt 199,0     |
| 40 shot    |  | 21: 10,5* ↗<br>22: 10,1 ↗<br>23: 10,5* ↖<br>24: 10,2* ↑<br>25: 10,2* ↑<br>26: 10,0 →<br>27: 10,5* ↑<br>28: 10,2* ↖<br>29: 10,5* →<br>30: 10,4* ↙<br>Serie 100,0<br>Totalt 299,0 | 40 shot   |
|            |   |   | 31: 10,7* ↓<br>32: 10,5* ↓<br>33: 10,7* ↗<br>34: 10,3* ↓<br>35: 10,8* ↗<br>36: 10,3* ↓<br>37: 10,4* ↗<br>38: 10,3* ↓<br>39: 10,7* ↑<br>40: 10,2* ↓<br>Serie 100,0<br>Totalt 399,0 |
| Umeå skf   |   |   |   |

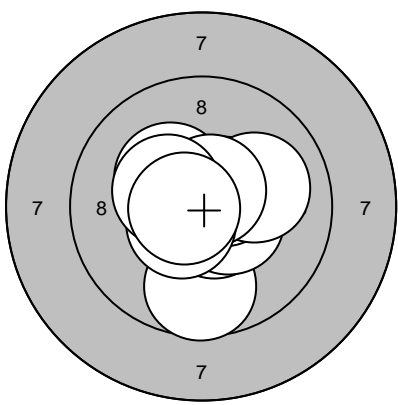
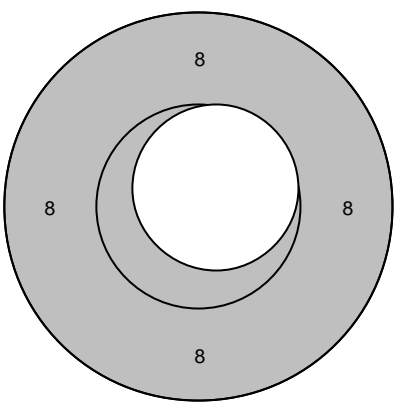
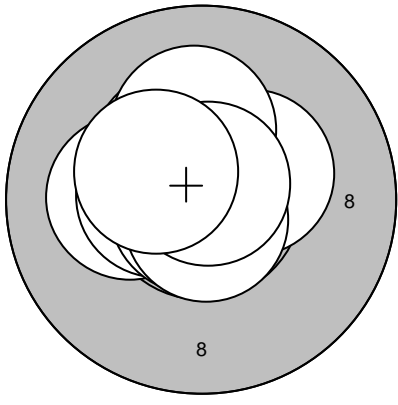
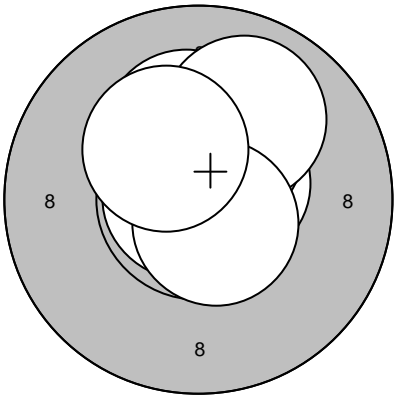
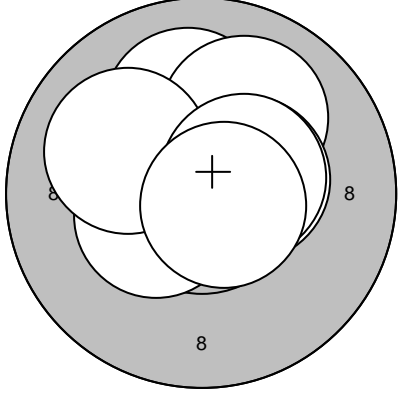
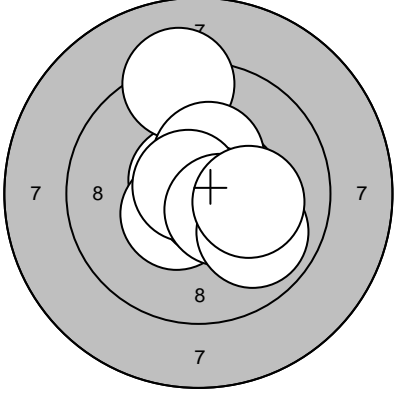
| Skjutlag   | Tavla   | Viktor Strand   |   |
|------------|---|---|---|
| 2          | 40  |   |   |
| STPL       | Ramselefors   |   |   |
| 2009-01-17 | Skyttiaden 2009   | Umeå skytteallians  |   |
| Sight      |    | 1: 9,7 ↓<br>2: 10,6* ↓<br>3: 10,5* →<br>4: 10,5* ↗<br>5: 10,0 →<br>6: 10,3* ↗<br>7: 10,6* ↗<br>8: 10,6* ↙<br>9: 10,4* ↖<br>10: 10,7* ←          | Sight<br>     |
|            | Serie 99,0  |   | 11: 10,7* ↗   |
|            | Totalt 0,0  |   | Serie 10,0  |
|            |   |   | Totalt 0,0  |
| 40 shot    |   | 1: 10,7* ←<br>2: 10,3* →<br>3: 10,2* ←<br>4: 10,5* ←<br>5: 10,4* ↗<br>6: 10,8* ↓<br>7: 10,7* ↓<br>8: 10,2* ↑<br>9: 10,8* ↗<br>10: 10,4* ↖       | 40 shot<br>  |
|            | Serie 100,0   |   | 11: 10,6* ↗   |
|            | Totalt 100,0  |   | 12: 10,2* ↑   |
|            |   |   | 13: 10,7* ↓   |
|            |   |   | 14: 10,3* ↑   |
|            |   |   | 15: 10,8* ←   |
|            |   |   | 16: 10,6* ↗   |
|            |   |   | 17: 10,3* ↗   |
|            |   |   | 18: 10,0 ↗  |
|            |   |   | 19: 10,6* ↓   |
|            |   |   | 20: 10,3* ↗   |
|            | Serie 100,0   |   | Serie 100,0   |
|            | Totalt 100,0  |   | Totalt 200,0  |
| 40 shot    |  | 21: 10,4* ↗<br>22: 10,4* ←<br>23: 10,1 ↑<br>24: 10,0 ↗<br>25: 10,7* →<br>26: 10,7* →<br>27: 10,4* →<br>28: 10,0 ↗<br>29: 10,5* →<br>30: 10,7* ↓ | 40 shot<br> |
|            | Serie 100,0   |   | 31: 10,5* →   |
|            | Totalt 300,0  |   | 32: 10,7* ↗   |
|            |   |   | 33: 10,5* ↖   |
|            |   |   | 34: 9,2 ↑   |
|            |   |   | 35: 10,4* ↑   |
|            |   |   | 36: 10,7* ↓   |
|            |   |   | 37: 10,8* ↗   |
|            |   |   | 38: 10,5* ↓   |
|            |   |   | 39: 9,9 ↓   |
|            |   |   | 40: 10,2* →   |
|            | Serie 100,0   |   | Serie 98,0  |
|            | Totalt 300,0  |   | Totalt 398,0  |
| Umeå skf   |   |   |   |

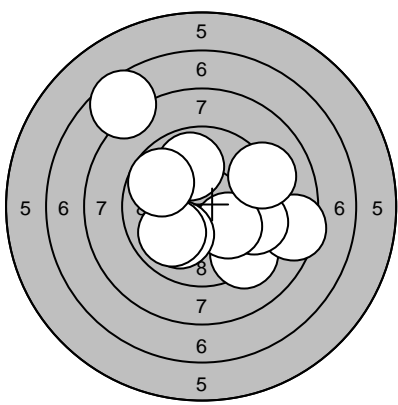
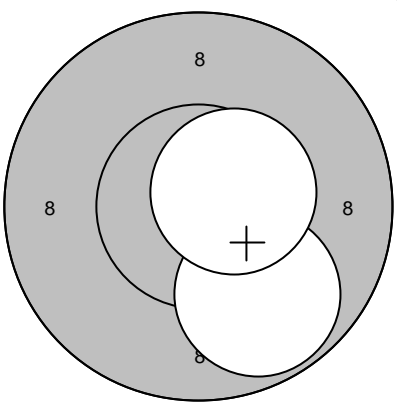
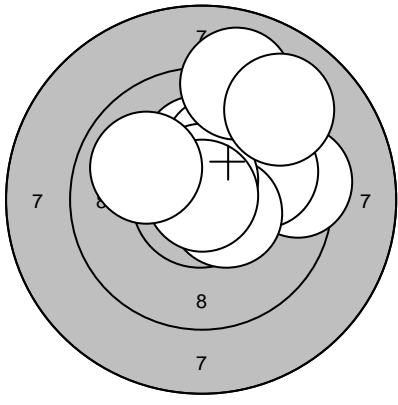
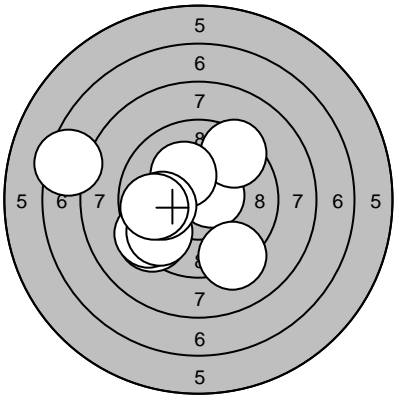
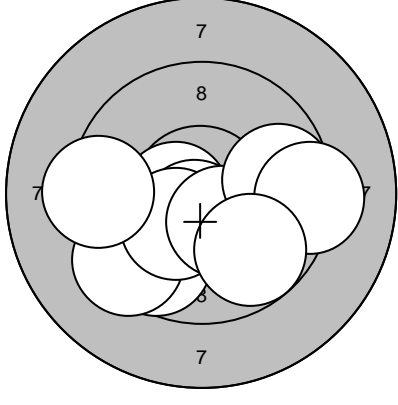
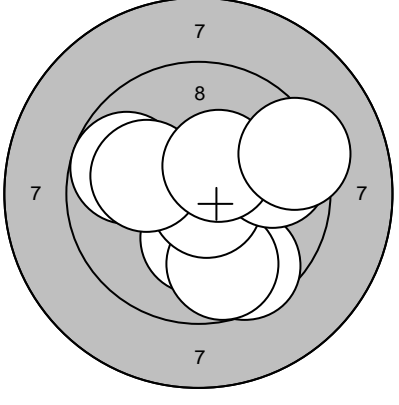
| Skjutlag   | Tavla   | Mattias Lundström  |   |
|------------|---|--|---|
| 3          | 1   |  |   |
| STPL       | Flarken   |  |   |
| 2009-01-17 | Skyttiaden 2009   | Umeå skytteallians   |   |
| Sight      |    | 1: 9,2 ↘<br>2: 8,5 →<br>3: 9,5 →<br>4: 10,0 ↘<br>5: 10,0 ↘<br>6: 9,9 ↙<br>7: 7,6 ↗<br>8: 9,9 ↗<br>9: 9,2 ↗<br>10: 9,8 ↖<br>Serie 89,0<br>Totalt 0,0                  | Sight<br>   |
|            |   |  | 11: 9,8 ↘<br>12: 10,5* →<br>Serie 19,0<br>Totalt 0,0  |
| 40 shot    |   | 1: 10,2* ↑<br>2: 9,4 →<br>3: 10,1 ↑<br>4: 9,9 →<br>5: 10,5* →<br>6: 10,7* ↑<br>7: 9,0 ↑<br>8: 10,9* ↗<br>9: 9,1 ↗<br>10: 10,0 ↖<br>Serie 96,0<br>Totalt 96,0         | 40 shot<br>  |
|            |   |  | 11: 10,6* →<br>12: 9,5 ↗<br>13: 9,4 ↙<br>14: 9,4 ↙<br>15: 10,2* ↗<br>16: 7,4 ←<br>17: 9,2 ↘<br>18: 9,6 ↙<br>19: 10,0 ←<br>20: 9,8 ←<br>Serie 91,0<br>Totalt 187,0     |
| 40 shot    |  | 21: 10,5* ←<br>22: 9,7 ↘<br>23: 9,4 ↙<br>24: 10,6* ↘<br>25: 10,3* ↘<br>26: 10,4* ↘<br>27: 9,3 ←<br>28: 9,7 →<br>29: 9,2 →<br>30: 9,7 ↘<br>Serie 94,0<br>Totalt 281,0 | 40 shot<br>   |
|            |   |  | 31: 10,4* ↘<br>32: 9,6 ↘<br>33: 10,2* ↘<br>34: 9,8 ↘<br>35: 10,8* ↘<br>36: 9,7 →<br>37: 9,7 ←<br>38: 10,1 ←<br>39: 10,4* ↗<br>40: 9,3 →<br>Serie 95,0<br>Totalt 376,0 |
| Umeå skf   |   |  |   |

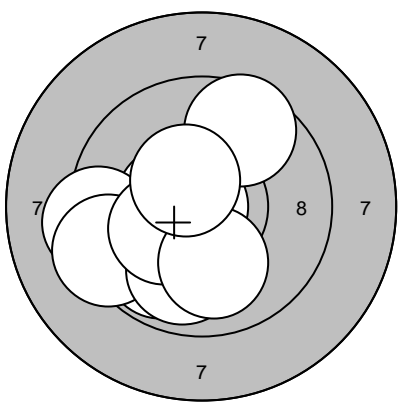
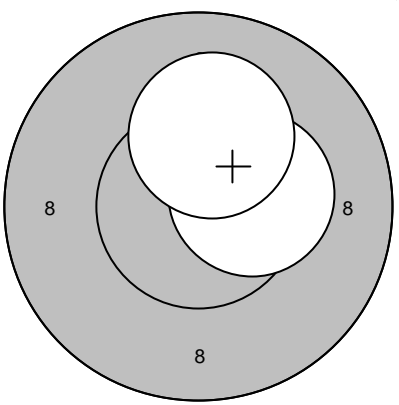
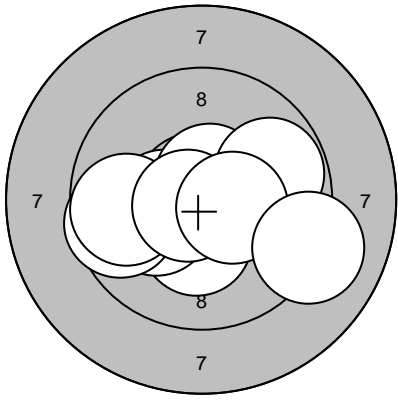
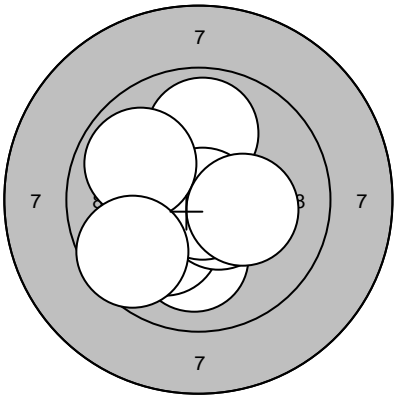
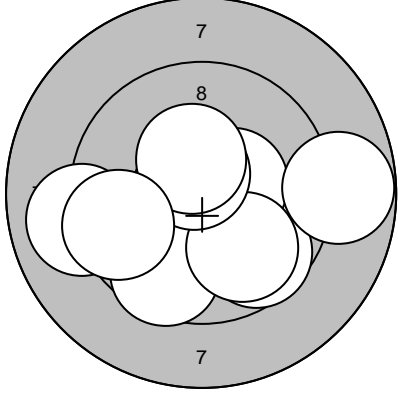
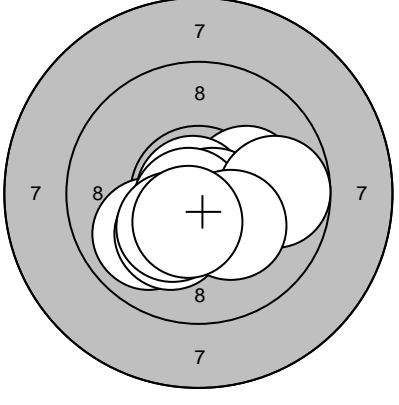
| Skjutlag   | Tavla   | Simon Jonsson      |  |
|------------|---|--------------------|--|
| STPL       | Bastuträsk  |                    |  |
| 2009-01-17 | Skyttiaden 2009   | Umeå skytteallians |  |
| Sight      |  <p>1: 9,9 ↘<br/>2: 10,5* ←<br/>3: 9,3 ←<br/>4: 9,3 ←<br/>5: 9,9 ↓<br/>6: 10,8* ←<br/>7: 10,3* ←<br/>8: 9,6 ↗<br/>9: 10,0 ↓<br/>10: 10,5* ↗</p> <p>Serie 95,0<br/>Totalt 0,0</p>             | Sight              |  <p>11: 10,4* →<br/>12: 10,2* ↑</p> <p>Serie 20,0<br/>Totalt 0,0</p>   |
| 40 shot    |  <p>1: 10,3* ↓<br/>2: 10,4* ←<br/>3: 10,2* ←<br/>4: 9,6 ←<br/>5: 10,6* ↗<br/>6: 9,8 ←<br/>7: 9,8 →<br/>8: 10,7* ←<br/>9: 10,4* →<br/>10: 9,1 →</p> <p>Serie 96,0<br/>Totalt 96,0</p>        | 40 shot            |  <p>11: 10,9* ↙<br/>12: 9,9 ↑<br/>13: 10,0 ↙<br/>14: 10,0 ↓<br/>15: 10,1 ↙<br/>16: 10,5* ↘<br/>17: 10,9* ↘<br/>18: 9,9 ↖<br/>19: 9,6 ↙<br/>20: 10,2* →</p> <p>Serie 97,0<br/>Totalt 193,0</p>       |
| 40 shot    |  <p>21: 10,5* ↓<br/>22: 9,7 ↘<br/>23: 9,0 ←<br/>24: 9,6 ↓<br/>25: 10,4* →<br/>26: 9,9 ↘<br/>27: 10,6* ↗<br/>28: 8,8 →<br/>29: 10,4* ↗<br/>30: 9,5 ↙</p> <p>Serie 93,0<br/>Totalt 286,0</p> | 40 shot            |  <p>31: 10,2* →<br/>32: 9,9 ↙<br/>33: 10,2* ↘<br/>34: 10,9* ←<br/>35: 10,7* ↘<br/>36: 10,7* ↘<br/>37: 9,7 →<br/>38: 10,2* ↘<br/>39: 10,3* ↘<br/>40: 10,4* ↓</p> <p>Serie 98,0<br/>Totalt 384,0</p> |
| Umeå skf   |   |                    |  |

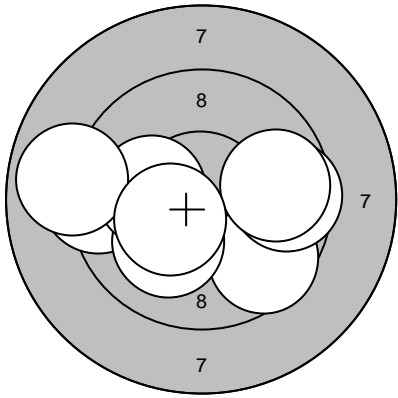
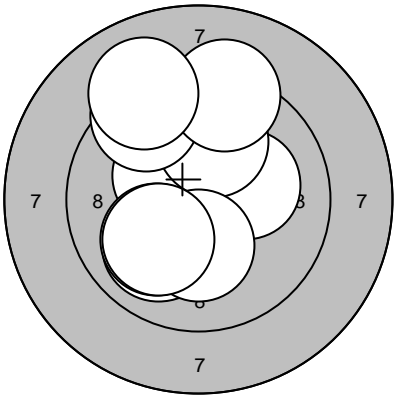
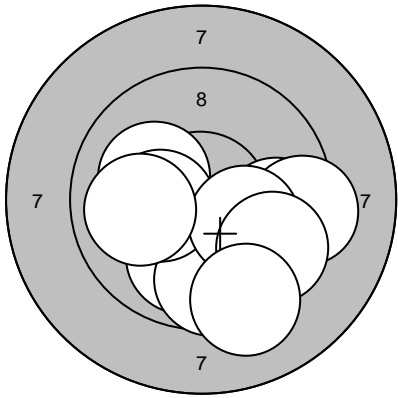
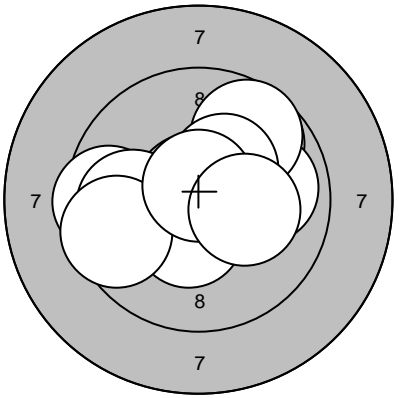
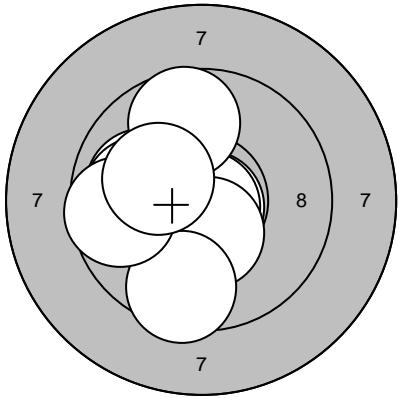
| Skjutlag  | Tavla  | Therese Karlsson  |  |
|---|--|---|--|
| 3   | 3  |   |  |
| STPL  | Drängsmark   |   |  |
| 2009-01-17  | Skyttiaden 2009  | Umeå skytteallians  |  |
| Sight   |  | 40 shot   |  |
|    | 1: 9,6 ↘<br>2: 9,6 →<br>3: 9,3 ←<br>4: 9,7 →<br>5: 10,1 ↘<br>6: 10,1 ←<br>7: 8,9 ←<br>8: 10,4* ↙   |   | 1: 10,0 ↙<br>2: 10,2* →<br>3: 10,3* ↖<br>4: 10,0 ↙<br>5: 10,0 ↑<br>6: 10,2* ↓<br>7: 10,0 ↙<br>8: 9,4 ↖<br>9: 9,3 ↑<br>10: 9,1 ↖        |
|   | Serie 74,0   |   | Serie 97,0   |
|   | Totalt 0,0   |   | Totalt 97,0  |
| 40 shot   |  | 40 shot   |  |
|   | 11: 9,7 →<br>12: 9,3 →<br>13: 10,1 ↗<br>14: 10,0 ↓<br>15: 9,7 ↓<br>16: 10,3* ←<br>17: 10,2* →<br>18: 9,6 ↘<br>19: 10,0 ←<br>20: 9,2 ↓      |  | 21: 9,8 ↗<br>22: 9,9 →<br>23: 9,7 ↗<br>24: 10,3* ↗<br>25: 9,5 ←<br>26: 9,9 ←<br>27: 10,4* ↓<br>28: 9,5 ←<br>29: 10,7* ↑<br>30: 10,2* → |
|   | Serie 95,0   |   | Serie 94,0   |
|   | Totalt 192,0   |   | Totalt 286,0   |
| 40 shot   |  |   |  |
|  | 31: 10,8* ↘<br>32: 10,0 ←<br>33: 10,8* ↘<br>34: 10,2* ←<br>35: 10,0 ←<br>36: 10,4* ↓<br>37: 9,7 ↑<br>38: 9,5 ↓<br>39: 9,7 ←<br>40: 10,2* ↖ |   |  |
|   | Serie 97,0   |   |  |
|   | Totalt 383,0   |   |  |
| Umeå skf  |  |   |  |

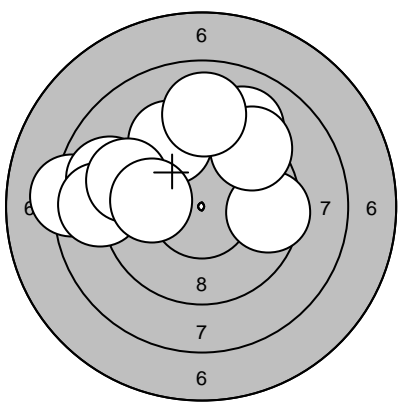
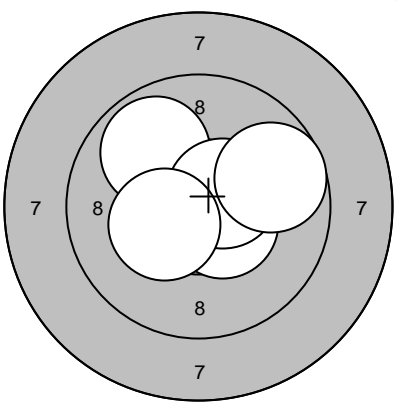
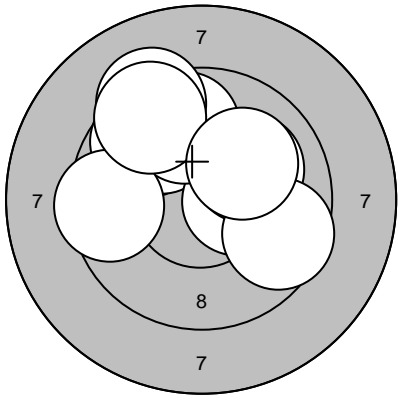
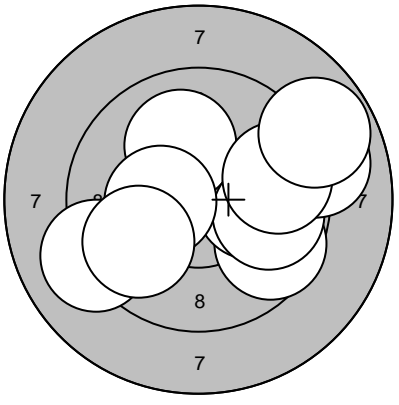
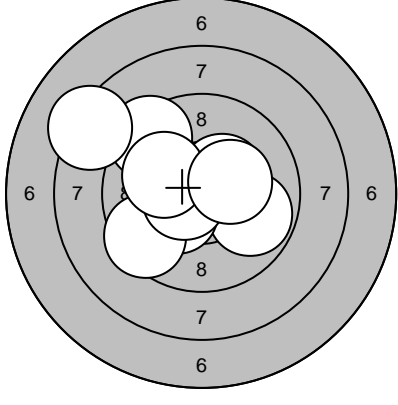
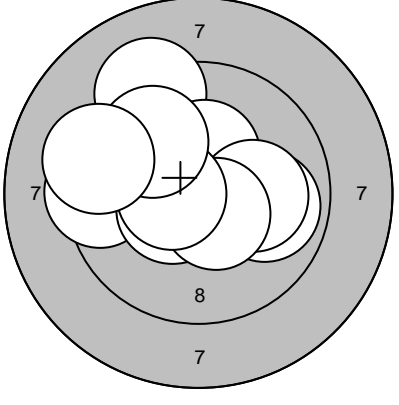
|   |                   |  |              |
|---|-------------------|--|--------------|
| Skjutlag<br><b>3</b>  | Tavla<br><b>4</b> | <b>Elin Jonsson</b>  |              |
| STPL  |                   | Bjurholm-Balsjö  |              |
| 2009-01-17  |                   | Skyttiaden 2009  |              |
| Sight   |                   | Sight  |              |
|    | 1: 8,2 ←          |    | 11: 10,5* ↘  |
|   | 2: 8,9 ←          |  | 12: 9,9 ↗    |
|   | 3: 9,1 ↗          |  | 13: 10,5* ↗  |
|   | 4: 8,8 ←          |  | 14: 9,7 →    |
|   | 5: 9,5 ↗          |  | 15: 10,3* ←  |
|   | 6: 9,5 →          |  |              |
|   | 7: 9,3 ←          |  |              |
|   | 8: 9,9 ←          |  |              |
|   | 9: 9,3 ↗          |  |              |
|   | 10: 9,0 ↑         |  |              |
|   | Serie 87,0        |  | Serie 48,0   |
|   | Totalt 0,0        |  | Totalt 0,0   |
| 40 shot   |                   | 40 shot  |              |
|   | 1: 9,7 ↗          |   | 11: 9,6 ↘    |
|   | 2: 9,8 ↗          |  | 12: 9,1 ←    |
|   | 3: 10,3* →        |  | 13: 10,1 →   |
|   | 4: 10,1 →         |  | 14: 10,1 ↑   |
|   | 5: 9,6 ↘          |  | 15: 9,8 →    |
|   | 6: 9,8 ↗          |  | 16: 10,3* ←  |
|   | 7: 9,2 ↗          |  | 17: 9,0 →    |
|   | 8: 9,5 ←          |  | 18: 9,8 ↙    |
|   | 9: 9,4 ↗          |  | 19: 9,7 →    |
|   | 10: 10,1 ↗        |  | 20: 8,8 ↗    |
|   | Serie 93,0        |  | Serie 92,0   |
|   | Totalt 93,0       |  | Totalt 185,0 |
| 40 shot   |                   | 40 shot  |              |
|  | 21: 10,4* ↗       |  | 31: 9,4 ←    |
|   | 22: 10,9* ↓       |  | 32: 9,9 →    |
|   | 23: 9,8 →         |  | 33: 9,2 ↗    |
|   | 24: 10,3* ↙       |  | 34: 10,5* ↙  |
|   | 25: 9,5 ↙         |  | 35: 10,4* ↑  |
|   | 26: 9,4 ↗         |  | 36: 10,1 →   |
|   | 27: 10,6* ←       |  | 37: 10,5* ↘  |
|   | 28: 10,1 ↗        |  | 38: 10,5* ←  |
|   | 29: 10,3* →       |  | 39: 9,9 ↗    |
|   | 30: 8,3 ↙         |  | 40: 9,3 ←    |
|   | Serie 95,0        |  | Serie 95,0   |
|   | Totalt 280,0      |  | Totalt 375,0 |
| <b>Umeå skf</b>   |                   |  |              |

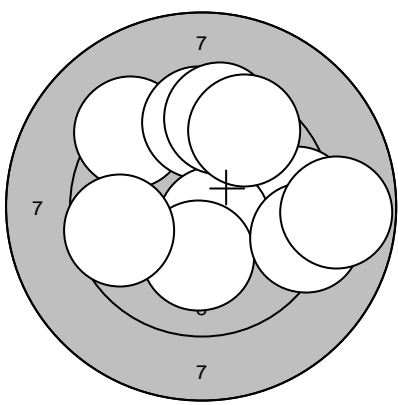
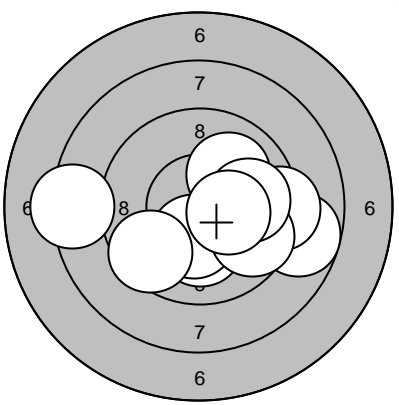
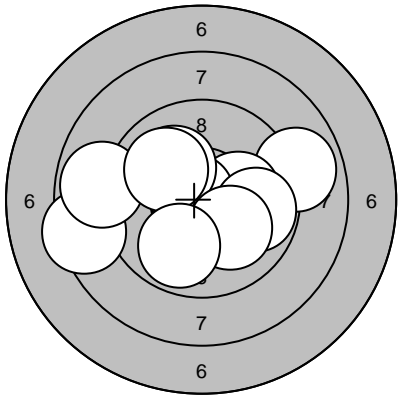
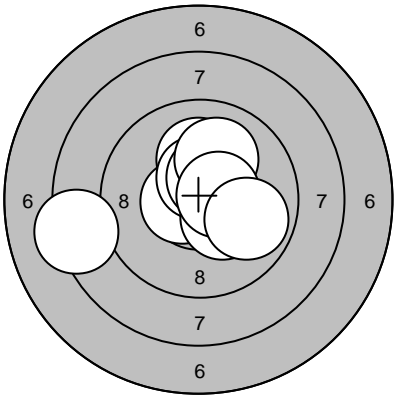
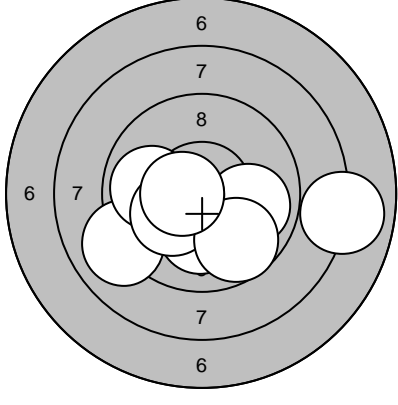
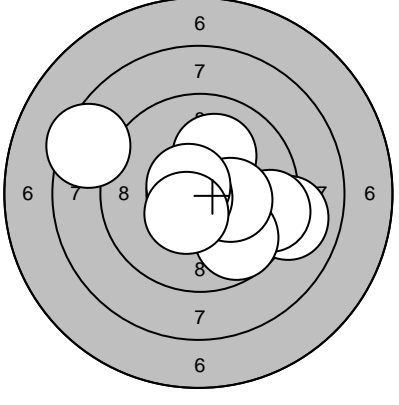

| Skjutlag   | Tavla   | Frida Lindfors   |  |
|------------|---|--|--|
| 3          | 5   |  |  |
| STPL       | Drängsmark  |  |  |
| 2009-01-17 | Skyttiaden 2009   | Umeå skytteallians   |  |
| Sight      |    | 1: 9,3 ↖<br>2: 9,4 →<br>3: 9,6 ↑<br>4: 10,6* ↘<br>5: 10,2* ↓<br>6: 9,2 →<br>7: 9,5 ↑<br>8: 8,8 →<br>9: 9,6 ←<br>10: 9,6 ↗<br>Serie 91,0<br>Totalt 0,0                | Sight    |
|            |   |  | 11: 10,1 ↓<br>12: 8,8 →<br>13: 10,0 ↗<br>14: 9,3 →<br>15: 10,3* ↓<br>16: 8,3 ←<br>17: 9,6 ↙<br>18: 9,7 ↘<br>19: 9,9 →<br>20: 10,3* →<br>Serie 92,0<br>Totalt 0,0           |
| 40 shot    |   | 1: 8,9 →<br>2: 8,4 ←<br>3: 8,9 ←<br>4: 10,1 →<br>5: 10,7* ↗<br>6: 9,8 →<br>7: 10,1 ↗<br>8: 10,1 ↘<br>9: 10,0 ↗<br>10: 9,9 ↘<br>Serie 92,0<br>Totalt 92,0             | 40 shot   |
|            |   |  | 11: 10,8* ↗<br>12: 10,6* ←<br>13: 10,1 ↑<br>14: 10,5* ↑<br>15: 10,3* ↘<br>16: 10,5* ↗<br>17: 10,0 ↗<br>18: 10,5* →<br>19: 8,3 ←<br>20: 9,9 ↘<br>Serie 97,0<br>Totalt 189,0 |
| 40 shot    |  | 21: 10,1 ↓<br>22: 10,1 ←<br>23: 9,0 ↙<br>24: 8,0 →<br>25: 9,9 ←<br>26: 9,9 →<br>27: 10,6* ←<br>28: 10,2* ↙<br>29: 9,7 ↘<br>30: 10,6* ←<br>Serie 94,0<br>Totalt 283,0 | 40 shot    |
|            |   |  | 31: 9,0 →<br>32: 9,4 →<br>33: 10,7* →<br>34: 9,7 ↘<br>35: 8,5 ←<br>36: 10,1 ↗<br>37: 10,2* →<br>38: 10,8* ←<br>39: 10,7* ↖<br>40: 10,5* ↘<br>Serie 95,0<br>Totalt 378,0    |
| Umeå skf   |   |  |  |

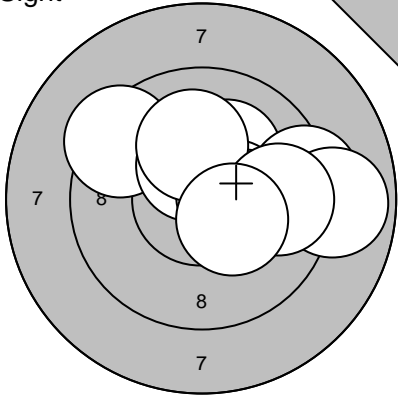
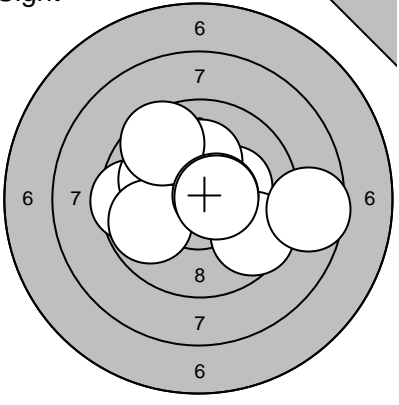
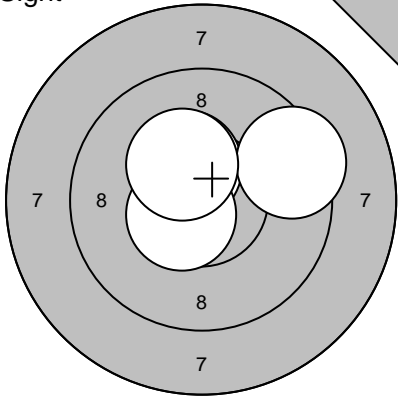
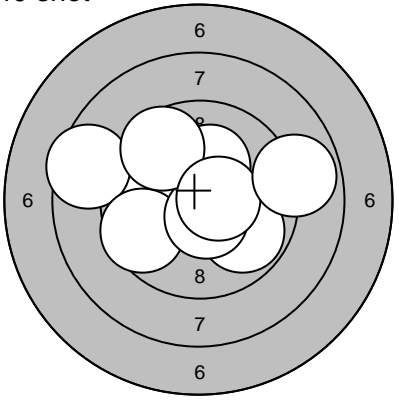
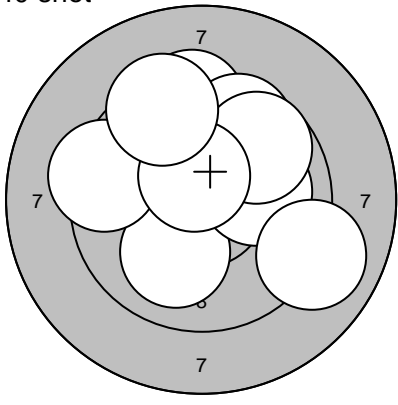
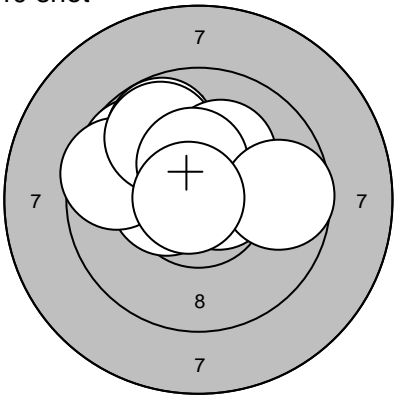
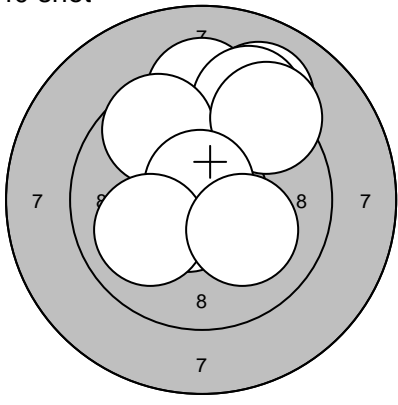
|   |  |  |  |
|---|--|--|--|
| Skjutlag<br><b>3</b>  | Tavla<br><b>6</b>  | <b>Ida Persson</b>   |  |
| STPL  |  | Flarken  |  |
| 2009-01-17  |  | Skyttiaden 2009  |  |
| Sight   |  | Umeå skytteallians   |  |
|    | 1: 9,4 ↖<br>2: 10,4* ↑<br>3: 10,2* ↗<br>4: 10,4* →<br>5: 10,3* →<br>6: 10,1 ↑<br>7: 9,3 →<br>8: 8,8 →<br>9: 9,7 →<br>10: 10,3* ↘       |    | 11: 9,6 ←<br>12: 10,2* →<br>13: 10,2* ↑<br>14: 10,1 ↖<br>15: 9,8 ←<br>16: 9,6 ↗<br>17: 9,6 ↘<br>18: 10,6* →<br>19: 8,6 →<br>20: 10,6* →  |
|   | Serie 95,0<br>Totalt 0,0   |  | Serie 94,0<br>Totalt 0,0   |
|   | 21: 10,4* ↑<br>22: 9,4 →<br>23: 10,6* ↖<br>24: 10,3* ↗   |   | 1: 10,5* ↑<br>2: 10,1 ←<br>3: 8,6 ↖<br>4: 9,6 ←<br>5: 10,2* ↑<br>6: 9,8 ↘<br>7: 10,6* ↘<br>8: 9,6 ↗<br>9: 10,5* →<br>10: 8,9 →           |
|   | Serie 39,0<br>Totalt 0,0   |  | Serie 93,0<br>Totalt 93,0  |
|  | 11: 10,3* ↑<br>12: 9,5 ↑<br>13: 9,7 ↗<br>14: 10,0 ↘<br>15: 9,4 ←<br>16: 10,1 →<br>17: 9,7 ↗<br>18: 10,6* ↑<br>19: 9,4 ↖<br>20: 9,0 ↘   |  | 21: 9,7 ↖<br>22: 10,4* ←<br>23: 9,6 ↖<br>24: 9,8 ↗<br>25: 10,6* →<br>26: 9,8 ↗<br>27: 10,2* ↗<br>28: 10,4* ↑<br>29: 9,7 →<br>30: 10,8* ← |
|   | Serie 94,0<br>Totalt 187,0   |  | Serie 95,0<br>Totalt 282,0   |
|  | 31: 10,6* ↘<br>32: 9,3 ↑<br>33: 10,7* ↖<br>34: 9,1 ↗<br>35: 9,2 ↗<br>36: 9,7 ↖<br>37: 9,3 ↗<br>38: 10,7* ↑<br>39: 10,0 ←<br>40: 10,1 ↘ |  |  |
|   | Serie 95,0<br>Totalt 377,0   |  |  |

Umeå skf

|                      |                   |                       |              |
|----------------------|-------------------|-----------------------|--------------|
| Skjutlag<br><b>3</b> | Tavla<br><b>7</b> | <b>Antonia Seidel</b> |              |
| STPL                 | Bastuträsk        |                       |              |
| 2009-01-17           | Skyttiaden 2009   | Umeå skytteallians    |              |
| Sight                |                   | 1: 9,3 ←              |              |
|                      |                   | 2: 8,7 →              |              |
|                      |                   | 3: 9,2 ↓              |              |
|                      |                   | 4: 10,3* ↗            |              |
|                      |                   | 5: 8,9 ←              |              |
|                      |                   | 6: 9,2 ←              |              |
|                      |                   | 7: 10,1 ↘             |              |
|                      |                   | 8: 10,9* ↙            |              |
|                      |                   | <b>Serie</b>          | <b>73,0</b>  |
|                      |                   | <b>Totalt</b>         | <b>0,0</b>   |
| 40 shot              |                   | 1: 9,5 →              |              |
|                      |                   | 2: 10,5* ←            |              |
|                      |                   | 3: 10,2* ←            |              |
|                      |                   | 4: 9,5 →              |              |
|                      |                   | 5: 10,0 →             |              |
|                      |                   | 6: 9,8 ↗              |              |
|                      |                   | 7: 8,2 ↗              |              |
|                      |                   | 8: 10,4* ←            |              |
|                      |                   | 9: 9,0 ←              |              |
|                      |                   | 10: 9,7 ↗             |              |
|                      |                   | <b>Serie</b>          | <b>93,0</b>  |
|                      |                   | <b>Totalt</b>         | <b>93,0</b>  |
| 40 shot              |                   | 11: 10,6* ←           |              |
|                      |                   | 12: 10,3* ↘           |              |
|                      |                   | 13: 10,8* ←           |              |
|                      |                   | 14: 10,9* ↘           |              |
|                      |                   | 15: 9,5 ←             |              |
|                      |                   | <b>Serie</b>          | <b>49,0</b>  |
|                      |                   | <b>Totalt</b>         | <b>142,0</b> |
| <b>Umeå skf</b>      |                   |                       |              |

|                      |                   |                       |             |
|----------------------|-------------------|-----------------------|-------------|
| Skjutlag<br><b>3</b> | Tavla<br><b>8</b> | <b>Antonia Seidel</b> |             |
| STPL                 |                   | Bastuträsk            |             |
| 2009-01-17           |                   | Skyttiaden 2009       |             |
| Sight                |                   | Sight                 |             |
|                      | 1: 10,6* ←        |                       |             |
|                      | 2: 10,2* ↙        |                       | 11: 8,8 ↙   |
|                      | 3: 10,6* →        |                       | 12: 9,8 ↙   |
|                      | 4: 9,5 ↓          |                       | 13: 10,5* → |
| 5: 10,2* →           | 14: 10,0 ↓        |                       |             |
| 6: 9,9 ↑             | 15: 9,6 ←         |                       |             |
| 7: 10,3* ↓           | 16: 10,7* ↑       |                       |             |
| 8: 9,4 ←             | 17: 9,7 ↓         |                       |             |
| 9: 9,8 ←             | 18: 10,4* ↓       |                       |             |
| 10: 9,8 ↖            | 19: 9,5 ←         |                       |             |
| Serie 95,0           | Serie 94,0        |                       |             |
| Totalt 0,0           | Totalt 0,0        |                       |             |
| 40 shot              | 40 shot           | 40 shot               | 40 shot     |
|                      | 1: 10,5* →        |                       |             |
|                      | 2: 10,1 ←         |                       | 11: 9,3 →   |
|                      | 3: 10,2* ↓        |                       | 12: 10,0 ←  |
|                      | 4: 10,0 ↗         |                       | 13: 10,3* ↗ |
| 5: 8,5 ↖             | 14: 10,0 ↘        |                       |             |
| 6: 10,6* ↓           | 15: 9,5 ↗         |                       |             |
| 7: 10,6* ↓           | 16: 10,7* ←       |                       |             |
| 8: 10,4* ↗           | 17: 9,8 ↗         |                       |             |
| 9: 10,3* ↓           | 18: 9,7 ←         |                       |             |
| 10: 9,7 →            | 19: 10,6* →       |                       |             |
| Serie 97,0           | Serie 96,0        |                       |             |
| Totalt 97,0          | Totalt 193,0      |                       |             |
| 40 shot              |                   |                       |             |
|                      | 21: 10,3* ↑       |                       |             |
|                      | 22: 9,7 ←         |                       |             |
|                      | 23: 10,6* ↑       |                       |             |
|                      | 24: 10,4* ↑       |                       |             |
| 25: 10,6* ←          |                   |                       |             |
| Serie 49,0           |                   |                       |             |
| Totalt 242,0         |                   |                       |             |

Umeå skf

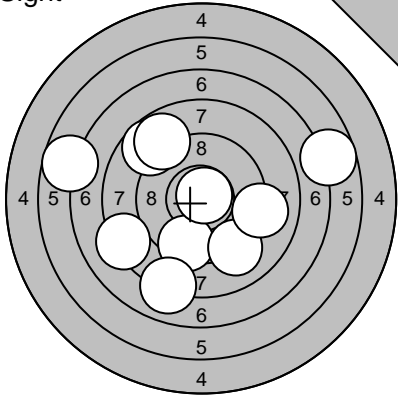
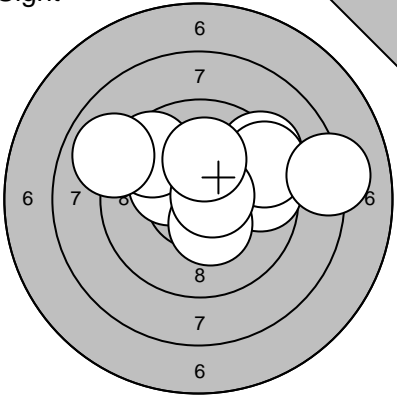
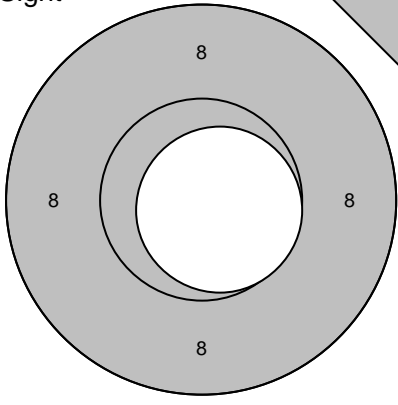
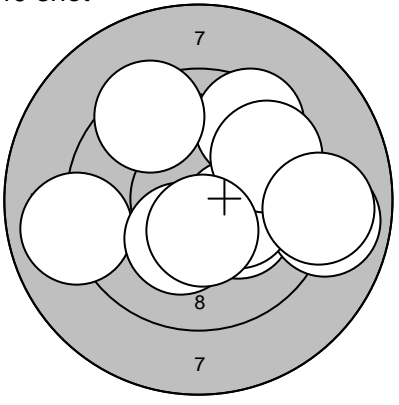
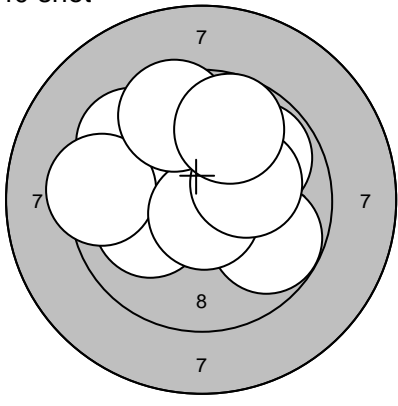
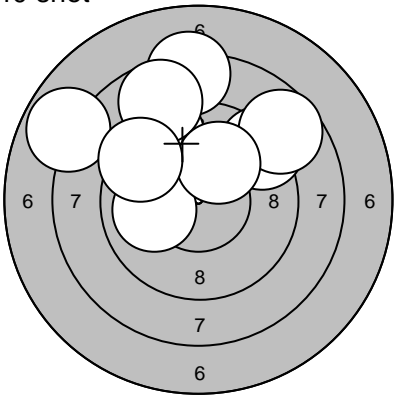
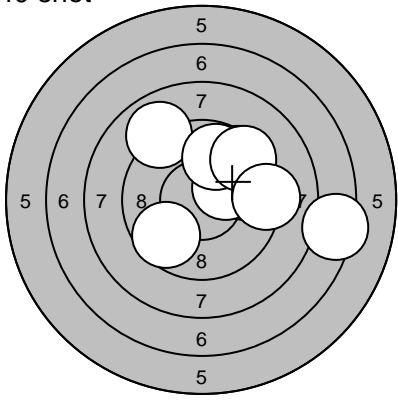
|   |   |  |   |
|---|---|--|---|
| Skjutlag<br><b>3</b>  | Tavla<br><b>9</b>   | <b>Ulrika Logardt</b>  |   |
| STPL  |   | Drängsmark   |   |
| 2009-01-17  |   | Skyttiaden 2009  |   |
| Sight   |   | Umeå skytteallians   |   |
|    | 1: 9,5 ↓<br>2: 8,0 ↓↓<br>3: 6,7 ←<br>4: 8,2 ←<br>5: 9,1 ↓↓<br>6: 9,1 →<br>7: 8,7 ↗<br>8: 10,8* ↗<br>9: 6,8 →<br>10: 8,8 ↗<br>Serie 81,0<br>Totalt 0,0               |    | 11: 9,6 →<br>12: 10,3* ↖<br>13: 9,4 ↗<br>14: 9,6 ↗<br>15: 9,4 →<br>16: 10,3* ↓<br>17: 9,0 ↗<br>18: 10,7* →<br>19: 8,2 →<br>20: 10,1 ↑<br>Serie 93,0<br>Totalt 0,0 |
|   | 21: 10,7* ↘<br>Serie 10,0<br>Totalt 0,0   |   | 1: 9,0 ←<br>2: 9,5 ↗<br>3: 9,4 ↗<br>4: 10,2* ↓<br>5: 10,3* ↓<br>6: 8,9 →<br>7: 10,3* →<br>8: 9,7 ↗<br>9: 9,0 →<br>10: 10,5* ↓<br>Serie 93,0<br>Totalt 93,0        |
|  | 11: 9,5 ↖<br>12: 10,1 ←<br>13: 9,7 →<br>14: 10,2* ↑<br>15: 9,4 ←<br>16: 9,8 ↗<br>17: 10,7* ↓<br>18: 9,5 ↑<br>19: 10,2* →<br>20: 9,7 ↑<br>Serie 94,0<br>Totalt 187,0 |  | 21: 9,2 ↗<br>22: 9,9 ↗<br>23: 10,0 ←<br>24: 9,4 ↗<br>25: 7,9 ↖<br>26: 8,3 ↑<br>27: 8,7 ↗<br>28: 8,7 ↑<br>29: 10,1 ↗<br>30: 9,5 ↖<br>Serie 87,0<br>Totalt 274,0    |
|  | 31: 9,8 ↗<br>32: 9,5 ↗<br>33: 9,7 ↓<br>34: 8,9 ↖<br>35: 9,8 →<br>36: 10,2* →<br>37: 9,8 ↑<br>38: 9,4 ↗<br>39: 7,4 →<br>40: 9,3 →<br>Serie 88,0<br>Totalt 362,0      |  |   |

Umeå skf

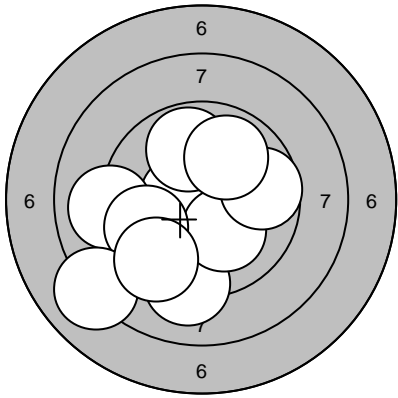
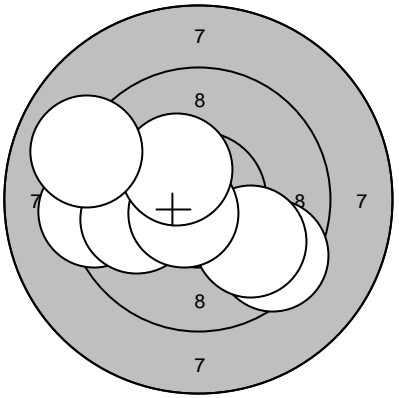
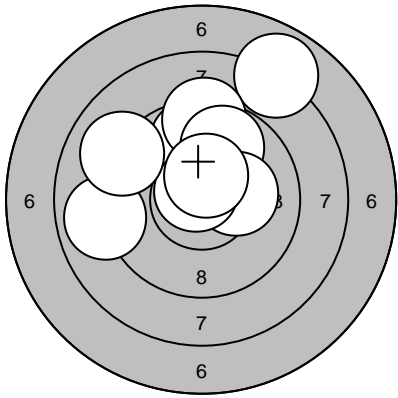
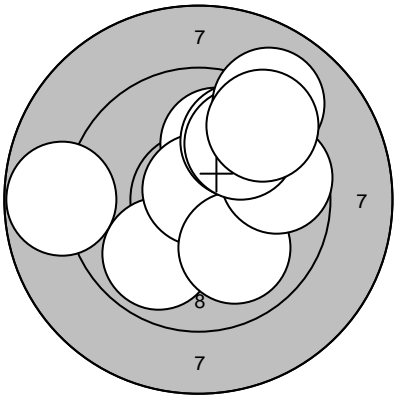
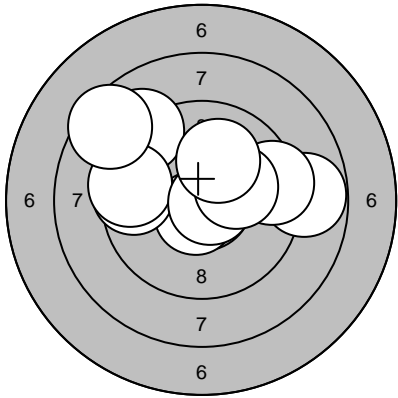
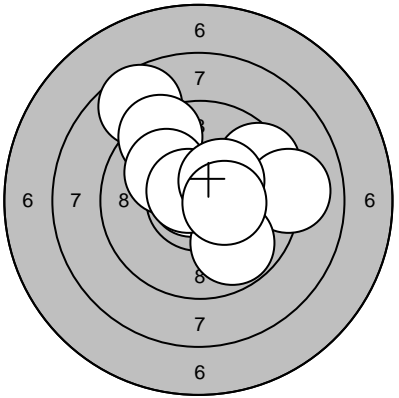
| Skjutlag  | Tavla  | Emma Andersson   |   |
|---|--|--|---|
| 3   | 10   |  |   |
| STPL  | Bjurholm-Balsjö  |  |   |
| 2009-01-17  | Skyttiaden 2009  | Umeå skytteallians   |   |
| Sight   |  | Sight  |   |
|    | 1: 10,6* ←<br>2: 9,1 ←<br>3: 9,2 ↓<br>4: 10,1 ↓<br>5: 9,7 ←<br>6: 9,9 ↑<br>7: 9,7 →<br>8: 8,1 ↓<br>9: 9,9 ↗<br>10: 9,4 ↘<br>Serie 91,0<br>Totalt 0,0               |    | 11: 9,3 ←<br>12: 9,5 ↘<br>13: 9,9 ↘<br>14: 9,9 ←<br>15: 10,6* ↘<br>16: 10,4* ↗<br>17: 9,0 ←<br>Serie 65,0<br>Totalt 0,0   |
| 40 shot   |  | 40 shot  |   |
|   | 1: 8,9 ←<br>2: 7,9 ↗<br>3: 9,7 ↑<br>4: 10,6* ↑<br>5: 9,3 ↑<br>6: 9,8 ↑<br>7: 10,2* →<br>8: 10,8* ↑<br>9: 10,5* ↑<br>10: 9,1 ←<br>Serie 91,0<br>Totalt 91,0         |   | 11: 9,9 ↘<br>12: 10,0 ↑<br>13: 10,8* ↑<br>14: 10,0 ↓<br>15: 9,7 →<br>16: 9,9 ↗<br>17: 9,9 ↗<br>18: 8,8 ←<br>19: 9,1 ↗<br>20: 9,4 ↗<br>Serie 92,0<br>Totalt 183,0      |
| 40 shot   |  | 40 shot  |   |
|  | 21: 9,0 ↗<br>22: 10,7* ↓<br>23: 9,5 ←<br>24: 9,4 ←<br>25: 8,5 ↗<br>26: 10,7* →<br>27: 8,8 →<br>28: 9,4 →<br>29: 10,1 →<br>30: 10,0 ↗<br>Serie 92,0<br>Totalt 275,0 |  | 31: 8,6 ↗<br>32: 9,4 ↗<br>33: 10,1 ↗<br>34: 10,8* ↗<br>35: 9,5 ↗<br>36: 9,0 →<br>37: 9,8 ↓<br>38: 10,7* ↗<br>39: 10,3* ↗<br>40: 10,4* →<br>Serie 94,0<br>Totalt 369,0 |
| Umeå skf  |  |  |   |

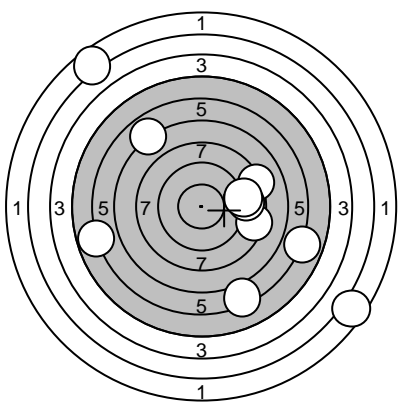
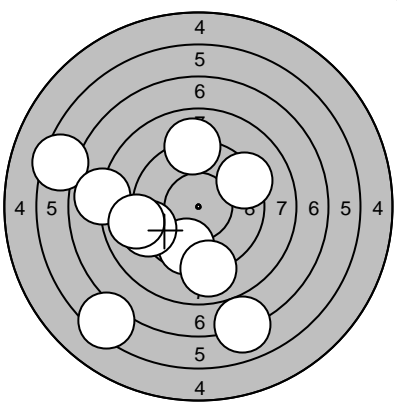
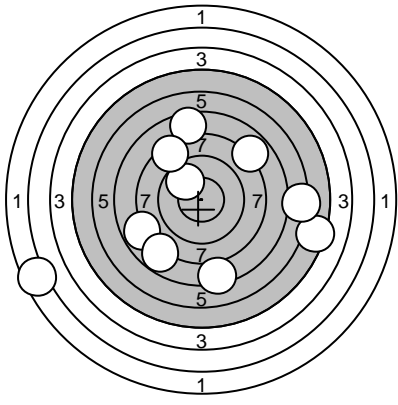
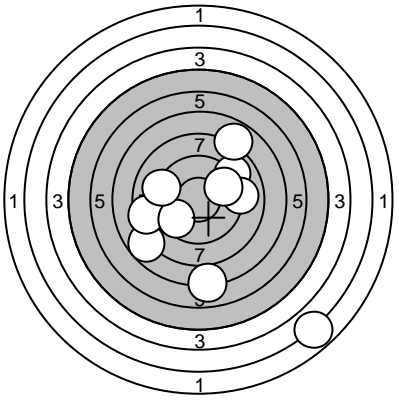
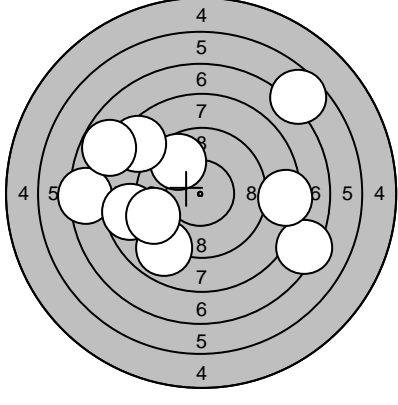
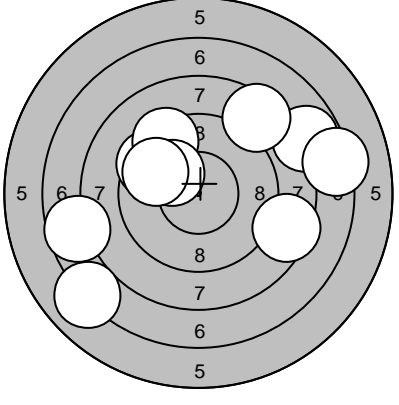
| Skjutlag   | Tavla   | Niklas Nilsson   |  |   |
|------------|---|--|--|---|
| STPL       | Rönnskär  |  |  |   |
| 2009-01-17 | Skyttiaden 2009   | Umeå skytteallians   |  |   |
| Sight      |    | 1: 6,9 ↖<br>2: 8,3 →<br>3: 8,1 →<br>4: 6,3 ↘<br>5: 8,8 →<br>6: 5,9 ←<br>7: 5,9 →<br>8: 2,5 ↘<br>9: 8,9 →<br>10: 2,6 ↖<br>Serie 58,0<br>Totalt 0,0            | Sight      | 11: 9,3 →<br>12: 6,4 ↘<br>13: 6,4 ←<br>14: 8,0 ←<br>15: 7,0 ↘<br>16: 9,7 ↘<br>17: 9,0 ↘<br>18: 9,1 ↑<br>19: 9,2 ←<br>20: 9,0 ←<br>Serie 81,0<br>Totalt 0,0    |
| 40 shot    |   | 1: 7,8 ←<br>2: 5,4 →<br>3: 7,3 ↘<br>4: 7,5 ↑<br>5: 9,9 ↖<br>6: 2,5 ←<br>7: 7,8 ↘<br>8: 6,2 →<br>9: 8,4 ↖<br>10: 7,9 ↖<br>Serie 65,0<br>Totalt 65,0           | 40 shot   | 11: 7,8 ←<br>12: 9,0 ↖<br>13: 8,5 ←<br>14: 9,0 →<br>15: 9,6 ↘<br>16: 9,2 ←<br>17: 2,9 ↘<br>18: 7,9 ↖<br>19: 7,0 ↘<br>20: 9,7 ↖<br>Serie 76,0<br>Totalt 141,0  |
| 40 shot    |  | 21: 7,3 ←<br>22: 9,8 ↖<br>23: 8,9 ↘<br>24: 8,7 ←<br>25: 8,5 ↖<br>26: 6,7 ↖<br>27: 7,8 ↖<br>28: 9,3 ←<br>29: 7,3 →<br>30: 8,3 →<br>Serie 77,0<br>Totalt 218,0 | 40 shot  | 31: 9,5 ↖<br>32: 7,8 ↖<br>33: 8,5 ↖<br>34: 7,0 ←<br>35: 7,6 ←<br>36: 9,4 ↖<br>37: 10,1 ↖<br>38: 9,7 ↖<br>39: 8,5 ↘<br>40: 7,3 →<br>Serie 81,0<br>Totalt 299,0 |
| Umeå skf   |   |  |  |   |

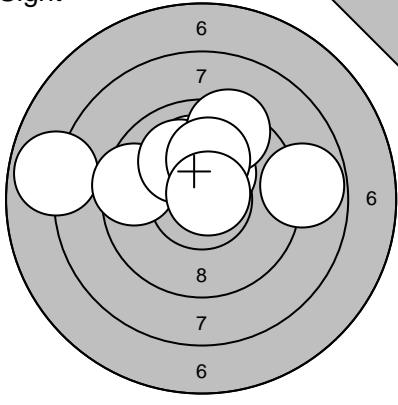
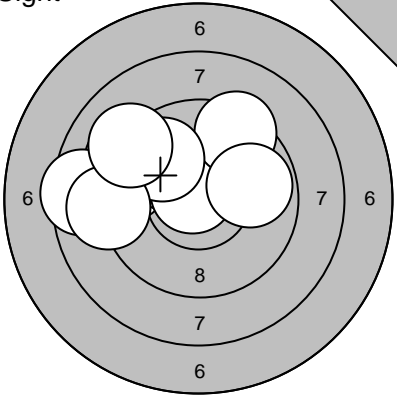
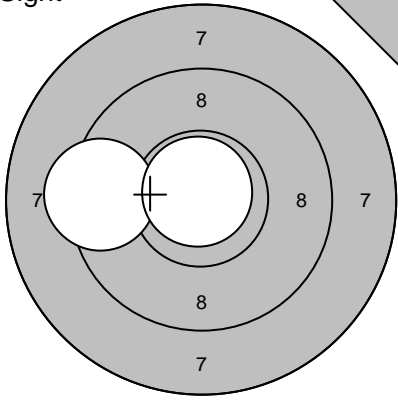
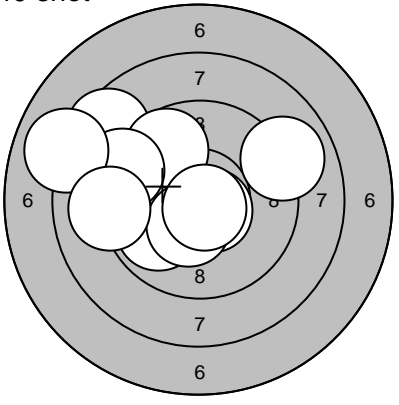
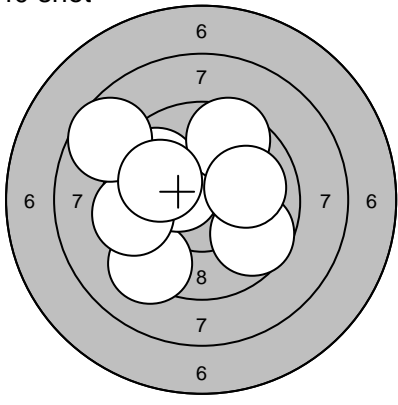
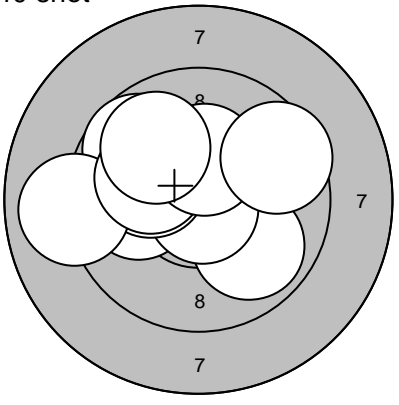
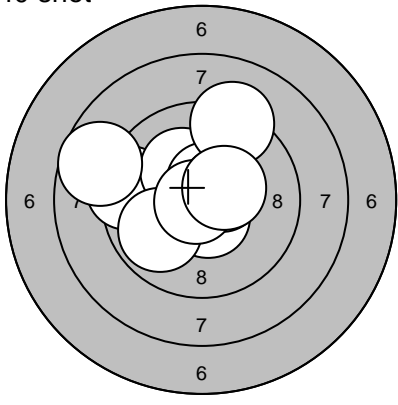
|  |  |   |  |
|--|--|---|--|
| Skjutlag<br><b>3</b>   | Tavla<br><b>13</b>   | <b>Oscar Kieri</b>  |  |
| STPL   |  | Umeå  |  |
| 2009-01-17   |  | Skyttiaden 2009   | Umeå skytteallians   |
| Sight<br>     | 1: 10,3* ↗<br>2: 7,9 ←<br>3: 10,5* ↑<br>4: 10,1 ↑<br>5: 9,5 ←<br>6: 10,1 ↗<br>7: 9,4 ↑<br>8: 10,1 ↑<br>9: 8,8 →<br>10: 10,8* ↗<br>Serie 93,0<br>Totalt 0,0               | Sight<br>     | 11: 9,4 ←<br>12: 9,3 ↗<br>13: 10,1 ↗<br>14: 10,8* ↗<br>15: 9,4 ↗<br>16: 8,5 ←<br>17: 9,8 ↗<br>18: 9,1 ←<br>19: 9,2 ↗<br>20: 9,8 →<br>Serie 91,0<br>Totalt 0,0        |
| Sight<br>    | 21: 9,3 ←<br>22: 10,8* ↗<br>Serie 19,0<br>Totalt 0,0   | 40 shot<br>  | 1: 10,6* ↘<br>2: 8,6 ↗<br>3: 9,8 ↗<br>4: 9,0 →<br>5: 9,9 ↘<br>6: 9,3 ↗<br>7: 10,4* ↘<br>8: 8,0 ↗<br>9: 9,1 ←<br>10: 10,7* ↘<br>Serie 91,0<br>Totalt 91,0             |
| 40 shot<br> | 11: 9,8 ←<br>12: 9,3 ↘<br>13: 9,8 ↗<br>14: 10,4* ↗<br>15: 9,6 ↑<br>16: 9,5 ←<br>17: 9,6 ↘<br>18: 8,7 ↗<br>19: 10,0 ↗<br>20: 10,0 →<br>Serie 92,0<br>Totalt 183,0         | 40 shot<br> | 21: 10,0 ←<br>22: 9,7 ↗<br>23: 9,9 ↘<br>24: 10,8* ↘<br>25: 10,2* ↗<br>26: 9,0 ←<br>27: 10,1 ↗<br>28: 10,3* ↑<br>29: 9,9 ↗<br>30: 9,5 ↗<br>Serie 95,0<br>Totalt 278,0 |
| 40 shot<br> | 31: 9,4 ←<br>32: 10,2* ↗<br>33: 10,6* ↘<br>34: 10,6* ↑<br>35: 10,5* ↗<br>36: 9,9 ↘<br>37: 10,8* ←<br>38: 9,2 ↑<br>39: 10,4* ↗<br>40: 8,7 ←<br>Serie 95,0<br>Totalt 373,0 |   |  |
| <b>Umeå skf</b>  |  |   |  |

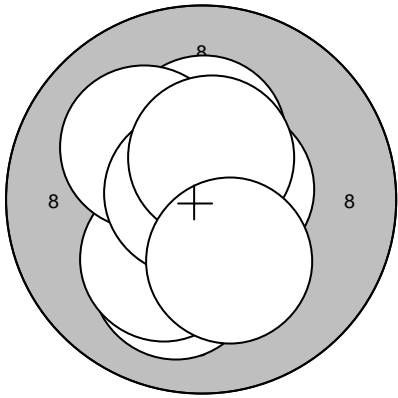
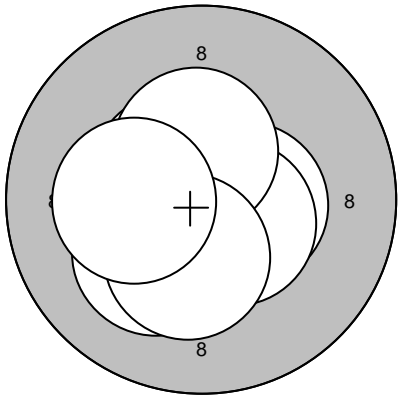
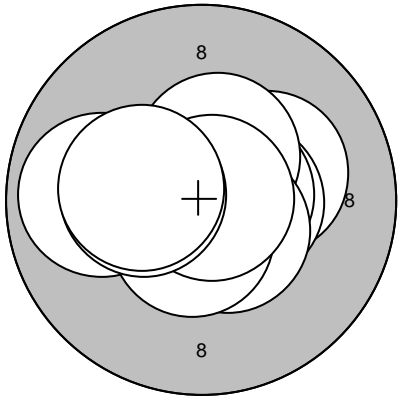

|                      |   |  |   |
|----------------------|---|--|---|
| Skjutlag<br><b>3</b> | Tavla<br><b>17</b>  | <b>Filip Viklund</b>   |   |
| STPL                 |   | Bastuträsk   |   |
| 2009-01-17           |   | Skyttiaden 2009  | Umeå skytteallians  |
| Sight                |    | 1: 10,1 ↓<br>2: 10,3* ↑<br>3: 10,5* ↓<br>4: 10,2* ↓<br>5: 10,1 ↗<br>6: 10,5* ↑<br>7: 10,6* →<br>8: 10,8* ←<br>9: 10,5* ↑<br>10: 10,2* ↓<br>Serie 100,0<br>Totalt 0,0           | Sight   |
|                      |   |  | 11: 10,8* ↓<br>12: 10,0 →<br>13: 10,6* ↙<br>Serie 30,0<br>Totalt 0,0  |
| 40 shot              |   | 1: 10,6* ↗<br>2: 10,5* ←<br>3: 10,5* →<br>4: 10,2* ↙<br>5: 10,7* ↗<br>6: 10,6* ↘<br>7: 10,5* ↘<br>8: 10,4* ↑<br>9: 10,3* ↓<br>10: 10,2* ←<br>Serie 100,0<br>Totalt 100,0       | 40 shot   |
|                      |   |  | 11: 10,4* ←<br>12: 10,2* ↘<br>13: 10,7* ↗<br>14: 10,4* ←<br>15: 10,5* →<br>16: 10,3* →<br>17: 10,7* ↑<br>18: 10,6* ↑<br>19: 10,7* →<br>20: 10,2* ↘<br>Serie 100,0<br>Totalt 200,0 |
| 40 shot              |  | 21: 10,2* →<br>22: 10,5* →<br>23: 10,6* →<br>24: 9,9 ←<br>25: 10,4* ↑<br>26: 10,5* ↘<br>27: 10,6* ↘<br>28: 10,8* →<br>29: 10,3* ←<br>30: 10,3* ←<br>Serie 99,0<br>Totalt 299,0 | 40 shot   |
|                      |   |  | 31: 10,8* ↘<br>32: 10,6* ↗<br>33: 9,5 ↗<br>34: 9,9 ↑<br>35: 10,8* ↘<br>36: 10,4* ↘<br>37: 9,7 ↘<br>38: 10,6* ←<br>39: 10,4* ↑<br>40: 10,1 ↘<br>Serie 97,0<br>Totalt 396,0         |
| <b>Umeå skf</b>      |   |  |   |

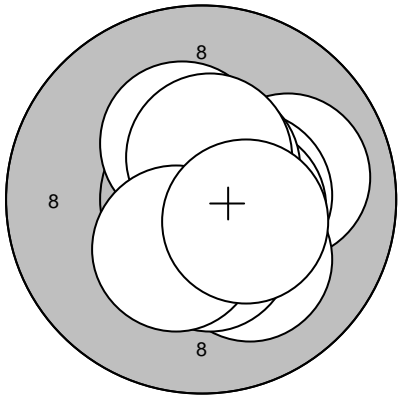
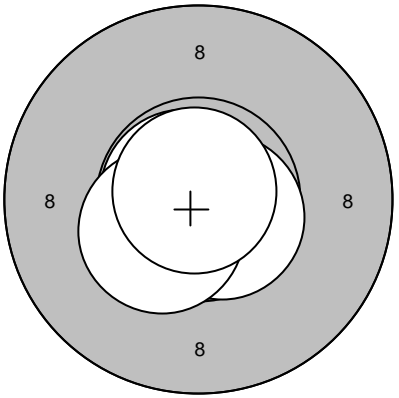
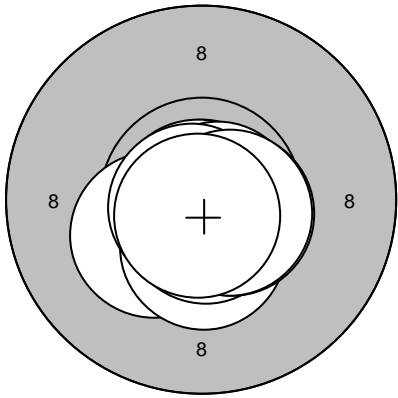
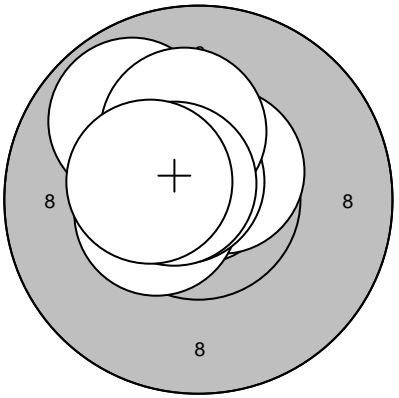
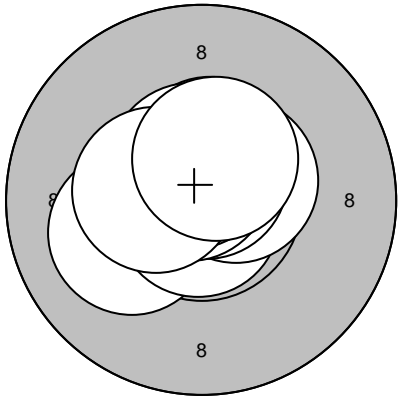
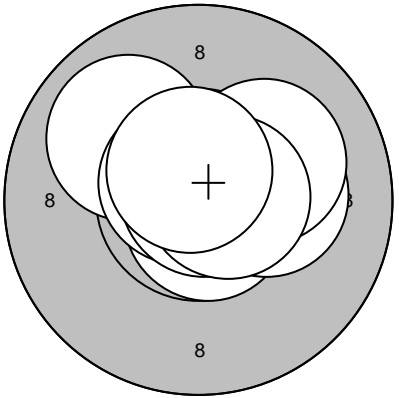
|                      |   |  |                    |  |   |
|----------------------|---|--|--------------------|--|---|
| Skjutlag<br><b>3</b> | Tavla<br><b>18</b>  | <b>Hanna Karlsson</b>  |                    |  |   |
| STPL                 |   | Gumboda/Ånåset   |                    |  |   |
| 2009-01-17           |   | Skyttiaden 2009  | Umeå skytteallians |  |   |
| Sight                |    | 1: 10,0 →<br>2: 10,1 ↓<br>3: 10,3* ↑<br>4: 10,4* →<br>5: 10,5* →<br>6: 10,6* ↑<br>7: 10,4* ↓<br>8: 10,5* ↑<br>9: 10,4* ↓<br>10: 10,4* →<br>Serie 100,0<br>Totalt 0,0             | Sight              |    | 11: 10,6* ↓<br>12: 10,8* ←<br>13: 10,4* ↙<br>14: 10,9* ↑<br>Serie 40,0<br>Totalt 0,0  |
| 40 shot              |   | 1: 10,3* ↙<br>2: 10,9* ↓<br>3: 10,9* ↙<br>4: 10,4* ↓<br>5: 10,8* →<br>6: 10,7* ↓<br>7: 10,6* →<br>8: 10,8* ↙<br>9: 10,6* →<br>10: 10,8* ↓<br>Serie 100,0<br>Totalt 100,0         | 40 shot            |   | 11: 10,8* ↑<br>12: 10,5* ←<br>13: 10,6* ↙<br>14: 10,6* ↗<br>15: 9,8 ↗<br>16: 10,5* ←<br>17: 10,7* ↗<br>18: 10,2* ↑<br>19: 10,6* ↙<br>20: 10,4* ←<br>Serie 99,0<br>Totalt 199,0  |
| 40 shot              |  | 21: 10,1 ↙<br>22: 10,8* ↑<br>23: 10,8* ↓<br>24: 10,5* ↑<br>25: 10,5* ↗<br>26: 10,7* ↑<br>27: 10,7* ↑<br>28: 10,6* ↑<br>29: 10,4* ←<br>30: 10,5* ↑<br>Serie 100,0<br>Totalt 299,0 | 40 shot            |  | 31: 10,7* ↑<br>32: 10,7* ↓<br>33: 10,7* ↑<br>34: 10,0 ↙<br>35: 10,2* →<br>36: 10,1 ↗<br>37: 10,7* ↗<br>38: 10,9* ↗<br>39: 10,6* →<br>40: 10,6* ↑<br>Serie 100,0<br>Totalt 399,0 |
| <b>Umeå skf</b>      |   |  |                    |  |   |

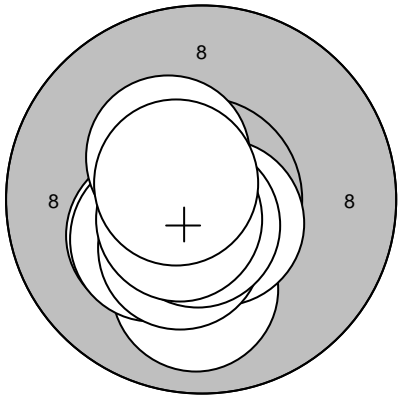
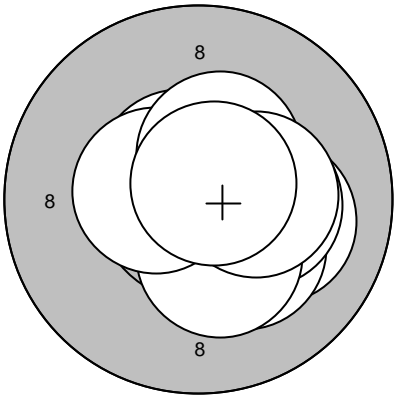
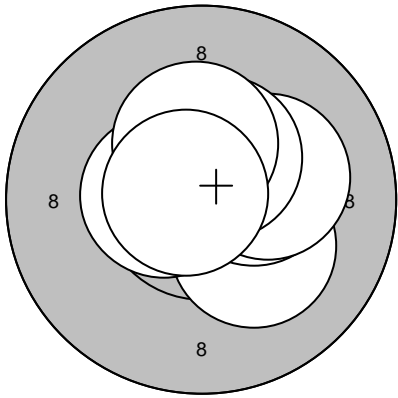
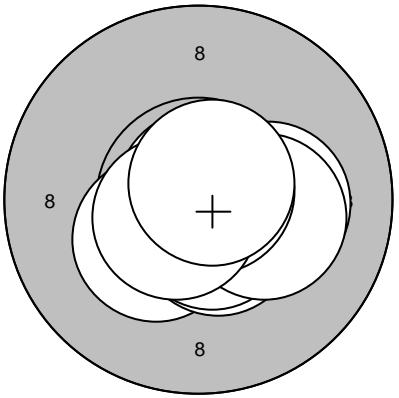
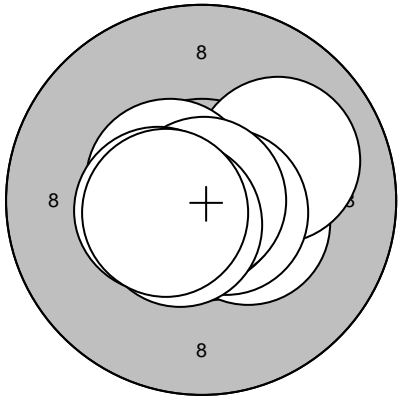
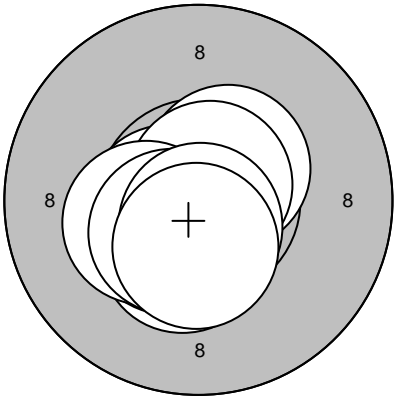
| Skjutlag   | Tavla   | Jasmine Frank   |  |
|------------|---|---|--|
| 3          | 19  |   |  |
| STPL       | Ramselefors   |   |  |
| 2009-01-17 | Skyttiaden 2009   | Umeå skytteallians  |  |
| Sight      |    | 1: 10,7* ↓<br>2: 10,0 ↓<br>3: 10,6* ↓<br>4: 10,3* ↙<br>5: 10,3* ↙<br>6: 10,4* ↗<br>7: 10,4* ↓<br>8: 10,7* ↓<br>9: 10,6* ↙<br>10: 10,6* ↖          | Sight    |
|            | Serie 100,0   |   | 11: 10,6* ↗<br>12: 10,1 →<br>13: 10,9* ↙<br>14: 10,2* ↘<br>15: 10,3* →<br>16: 10,3* ↓<br>17: 10,5* ←<br>18: 10,4* ↗<br>19: 10,3* →<br>20: 10,7* ↗  |
|            | Totalt 0,0  |   | Serie 100,0  |
|            |   |   | Totalt 0,0   |
| 40 shot    |   | 1: 10,7* →<br>2: 10,2* ↘<br>3: 10,7* ↗<br>4: 10,7* ↗<br>5: 10,4* →<br>6: 10,6* ←<br>7: 10,2* →<br>8: 10,5* ↗<br>9: 10,4* ↗<br>10: 10,8* ↖         | 40 shot   |
|            | Serie 100,0   |   | 11: 10,8* ↘<br>12: 10,3* ↙<br>13: 10,9* ↗<br>14: 10,5* ↘<br>15: 10,2* →<br>16: 10,6* ↘<br>17: 10,2* →<br>18: 10,8* ↗<br>19: 10,6* ↙<br>20: 10,7* ↗ |
|            | Totalt 100,0  |   | Serie 100,0  |
|            |   |   | Totalt 200,0   |
| 40 shot    |  | 21: 10,7* →<br>22: 10,4* →<br>23: 10,0 ↗<br>24: 10,6* →<br>25: 10,6* ↖<br>26: 10,9* ↓<br>27: 10,9* →<br>28: 10,5* ←<br>29: 10,6* ↘<br>30: 10,6* ↖ | 40 shot    |
|            | Serie 100,0   |   | 31: 10,6* ←<br>32: 10,7* ↓<br>33: 10,5* ↗<br>34: 10,7* ↗<br>35: 10,4* ↓<br>36: 10,5* ↘<br>37: 10,3* ←<br>38: 10,5* ↘<br>39: 10,7* ↓<br>40: 10,5* ↓ |
|            | Totalt 300,0  |   | Serie 100,0  |
|            |   |   | Totalt 400,0   |

Umeå skf

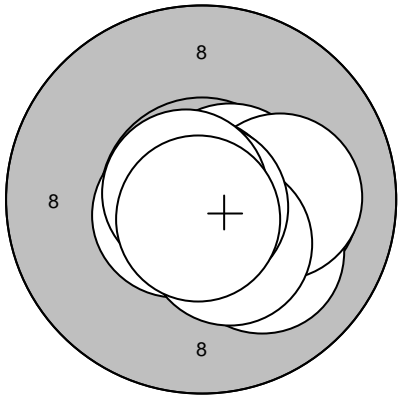
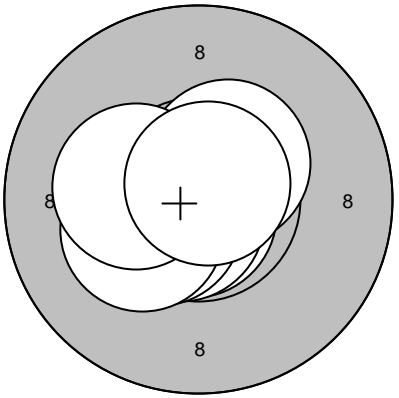
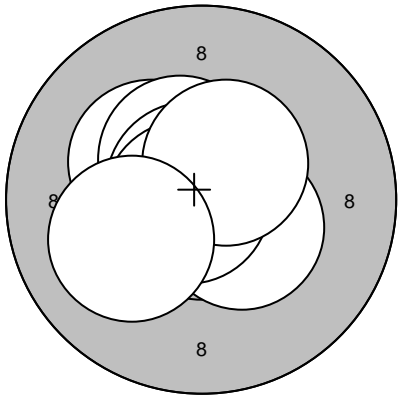
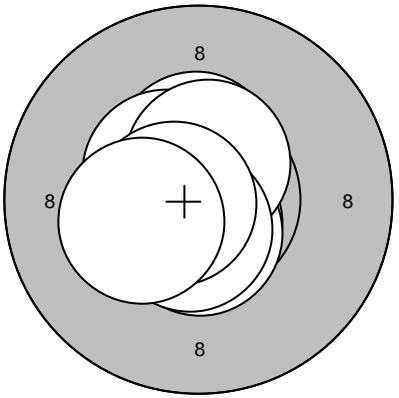
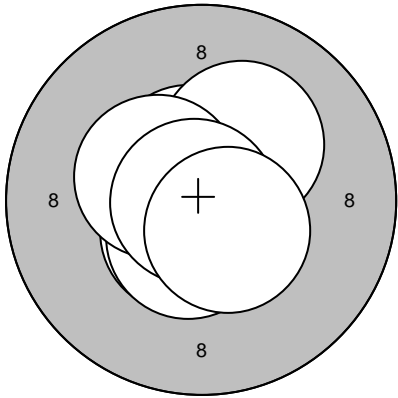
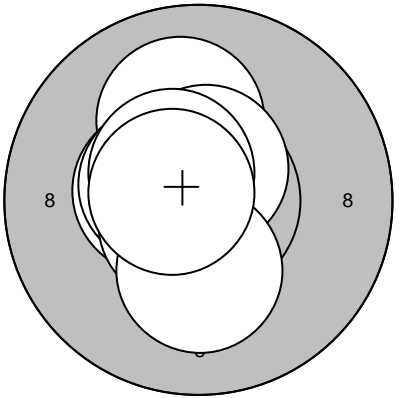
| Skjutlag   | Tavla   | Jimmy Eriksson  |   |
|------------|---|---|---|
| 3          | 20  |   |   |
| STPL       | Bjurholm-Balsjö   |   |   |
| 2009-01-17 | Skyttiaden 2009   | Umeå skytteallians  |   |
| Sight      |    | 1: 10,6* →<br>2: 10,1 →<br>3: 10,1 ↘<br>4: 10,6* ↙<br>5: 10,1 →<br>6: 10,4* ↘<br>7: 10,9* ←<br>8: 10,8* ↘<br>9: 10,8* ↖<br>10: 10,7* ↓<br>Serie 100,0<br>Totalt 0,0               | Sight   |
|            |   |   | 11: 10,8* ↓<br>12: 10,7* ↙<br>13: 10,5* ↖<br>14: 10,4* ↗<br>15: 10,3* ↖<br>16: 10,3* ←<br>17: 10,8* ↗<br>Serie 70,0<br>Totalt 0,0   |
| 40 shot    |   | 1: 10,7* →<br>2: 10,4* ↘<br>3: 10,3* ↗<br>4: 10,5* ↗<br>5: 10,7* ↗<br>6: 10,5* ↗<br>7: 10,8* ↗<br>8: 10,8* ←<br>9: 10,5* ↗<br>10: 10,1 ↙<br>Serie 100,0<br>Totalt 100,0           | 40 shot    |
|            |   |   | 11: 10,5* ↑<br>12: 10,7* ↓<br>13: 10,6* ←<br>14: 10,6* ↓<br>15: 10,7* ↘<br>16: 10,5* ↖<br>17: 10,5* ↑<br>18: 10,6* ↓<br>19: 10,7* ←<br>20: 10,3* ←<br>Serie 100,0<br>Totalt 200,0 |
| 40 shot    |  | 21: 10,6* ↙<br>22: 10,7* ↗<br>23: 10,6* ↗<br>24: 10,7* ↑<br>25: 10,2* ↗<br>26: 10,7* ↙<br>27: 10,5* ↙<br>28: 10,4* ↗<br>29: 10,9* ←<br>30: 10,5* ↘<br>Serie 100,0<br>Totalt 300,0 | 40 shot   |
|            |   |   | 31: 10,5* ↗<br>32: 10,7* ↗<br>33: 10,1 ↑<br>34: 10,5* ←<br>35: 10,5* ↖<br>36: 10,6* ↙<br>37: 10,6* ↑<br>38: 10,5* ↗<br>39: 10,2* ↓<br>40: 10,7* ←<br>Serie 100,0<br>Totalt 400,0  |

Umeå skf

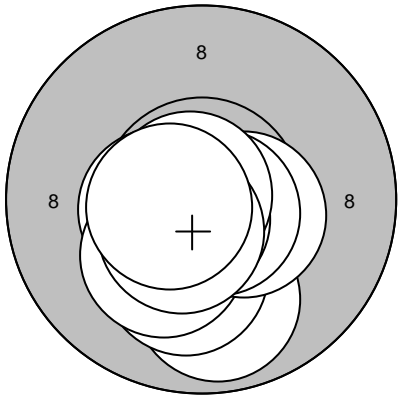
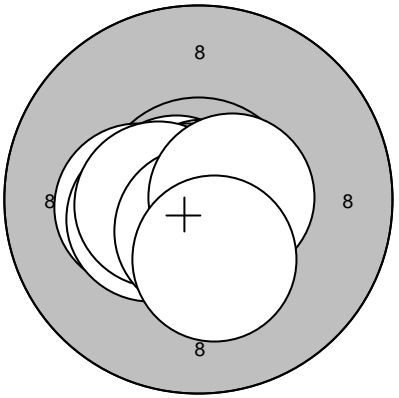
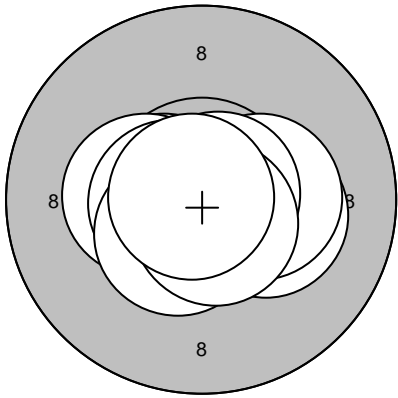
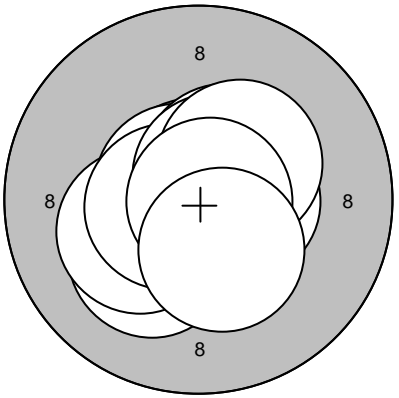
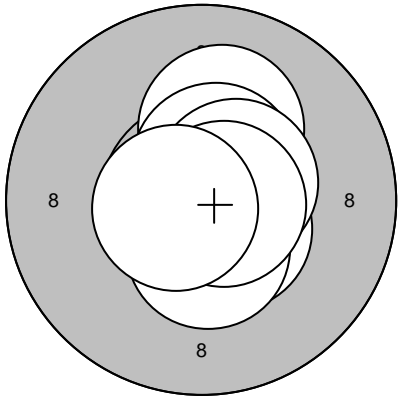
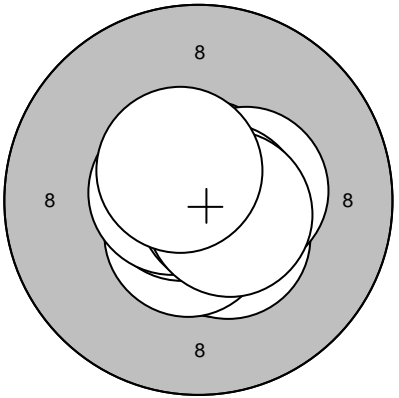
| Skjutlag   | Tavla           | Hilde Karlsson  |              |
|--|-----------------|---|--------------|
| 3  | 21              |   |              |
| STPL   | Gumboda/Ånäset  |   |              |
| 2009-01-17   | Skyttiaden 2009 | Umeå skytteallians  |              |
| Sight<br>     | 1: 9,9 ↓        | Sight<br>     | 11: 10,3* ←  |
|  | 2: 10,1 ↓       |   | 12: 10,7* ←  |
|  | 3: 10,5* ←      |   | 13: 10,9* ↘  |
|  | 4: 10,2* ↘      |   | 14: 10,6* ←  |
|  | 5: 10,5* →      |   | 15: 10,4* ←  |
|  | 6: 10,7* ↘      |   | 16: 10,8* ↘  |
|  | 7: 10,7* ↘      |   | 17: 10,5* ←  |
|  | 8: 10,8* ↗      |   | 18: 10,6* ↓  |
|  | 9: 10,6* ↘      |   | 19: 10,6* →  |
|  | 10: 10,6* ←     |   | 20: 10,3* ↓  |
|  | Serie 99,0      |   | Serie 100,0  |
|  | Totalt 0,0      |   | Totalt 0,0   |
| 40 shot<br>  | 1: 10,2* →      | 40 shot<br>  | 11: 10,2* ↘  |
|  | 2: 10,3* →      |   | 12: 10,7* ↖  |
|  | 3: 10,5* ←      |   | 13: 10,2* ←  |
|  | 4: 10,8* ↓      |   | 14: 10,5* ↗  |
|  | 5: 10,3* ←      |   | 15: 10,6* ←  |
|  | 6: 10,6* ←      |   | 16: 10,5* →  |
|  | 7: 10,8* →      |   | 17: 10,7* ↗  |
|  | 8: 10,5* ↘      |   | 18: 10,4* ↗  |
|  | 9: 10,6* ↘      |   | 19: 10,8* →  |
|  | 10: 10,8* ←     |   | 20: 10,4* ↓  |
|  | Serie 100,0     |   | Serie 100,0  |
|  | Totalt 100,0    |   | Totalt 200,0 |
| 40 shot<br> | 21: 10,5* ↘     | 40 shot<br> | 31: 10,7* ↗  |
|  | 22: 10,8* ↘     |   | 32: 10,5* ↓  |
|  | 23: 10,5* ↓     |   | 33: 10,4* ↓  |
|  | 24: 10,2* ↗     |   | 34: 10,4* →  |
|  | 25: 10,7* ↘     |   | 35: 10,6* ↓  |
|  | 26: 10,5* ↗     |   | 36: 10,8* ←  |
|  | 27: 10,5* →     |   | 37: 10,7* ←  |
|  | 28: 10,4* ↓     |   | 38: 10,7* ↘  |
|  | 29: 10,7* →     |   | 39: 10,6* ↘  |
|  | 30: 10,7* ←     |   | 40: 10,6* ↗  |
|  | Serie 100,0     |   | Serie 100,0  |
|  | Totalt 300,0    |   | Totalt 400,0 |

Umeå skf

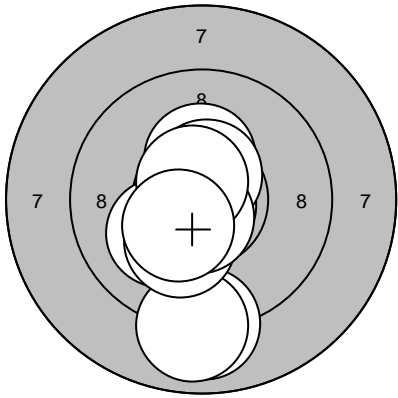
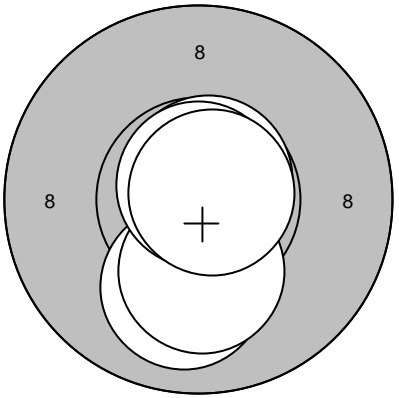
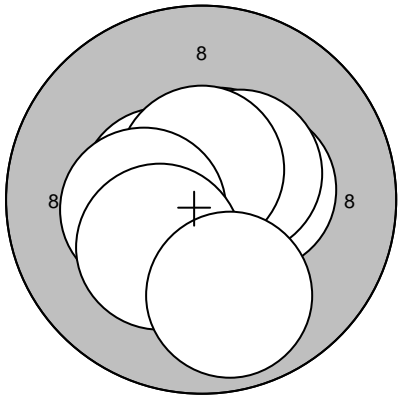
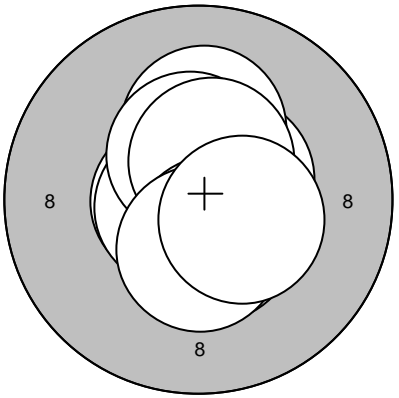
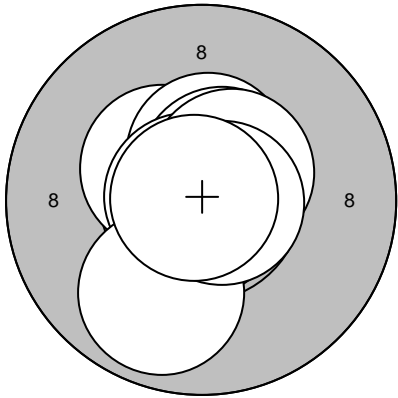
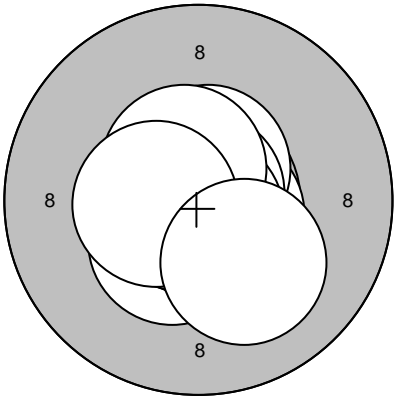
| Skjutlag   | Tavla   | Nils Lindkvist   |   |
|------------|---|--|---|
| 3          | 22  |  |   |
| STPL       | Drängsmark  |  |   |
| 2009-01-17 | Skyttiaden 2009   | Umeå skytteallians   |   |
| Sight      |    | 1: 9,0 ↓<br>2: 8,9 ↓<br>3: 10,8* ↓<br>4: 10,1 ↙<br>5: 10,3* ↑<br>6: 10,6* ↑<br>7: 10,2* ↓<br>8: 10,7* ↓<br>9: 10,6* ↑<br>10: 10,4* ↙<br>Serie 97,0<br>Totalt 0,0               | Sight   |
|            |   |  | 11: 10,0 ↓<br>12: 10,2* ↓<br>13: 10,7* ↑<br>14: 10,8* ↑<br>15: 10,8* →<br>Serie 50,0<br>Totalt 0,0  |
| 40 shot    |   | 1: 10,5* ←<br>2: 10,4* ↙<br>3: 10,4* →<br>4: 10,5* ←<br>5: 10,6* ↑<br>6: 10,4* ↗<br>7: 10,6* ↑<br>8: 10,3* ←<br>9: 10,3* ↙<br>10: 9,9 ↓<br>Serie 99,0<br>Totalt 99,0           | 40 shot    |
|            |   |  | 11: 10,7* ←<br>12: 10,7* ↑<br>13: 10,7* ←<br>14: 10,5* ↗<br>15: 10,2* ↑<br>16: 10,5* ↑<br>17: 10,5* ↑<br>18: 10,5* ↓<br>19: 10,4* ↓<br>20: 10,4* ↘<br>Serie 100,0<br>Totalt 199,0 |
| 40 shot    |  | 21: 10,4* ↖<br>22: 10,8* ↓<br>23: 10,5* ↑<br>24: 10,6* ↗<br>25: 10,7* ↗<br>26: 10,8* ←<br>27: 10,5* ↗<br>28: 9,9 ↓<br>29: 10,7* →<br>30: 10,9* ←<br>Serie 99,0<br>Totalt 298,0 | 40 shot   |
|            |   |  | 31: 10,4* ↙<br>32: 10,7* ↘<br>33: 10,6* ↑<br>34: 10,9* ↑<br>35: 10,8* ↙<br>36: 10,8* ↓<br>37: 10,8* ↙<br>38: 10,6* ↑<br>39: 10,5* ←<br>40: 10,1 ↓<br>Serie 100,0<br>Totalt 398,0  |
| Umeå skf   |   |  |   |

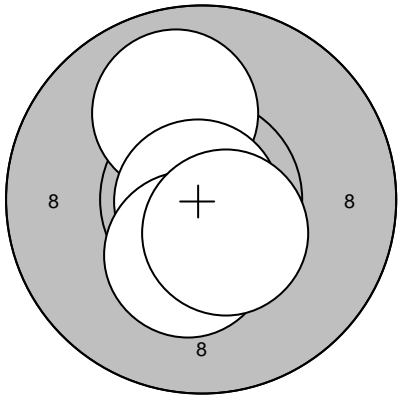
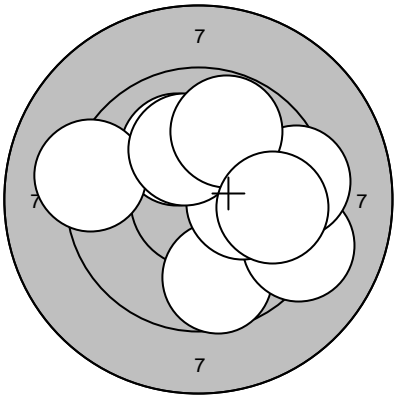
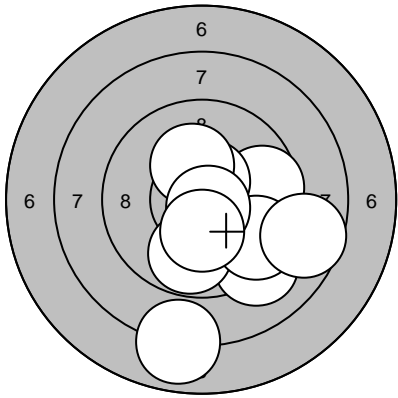
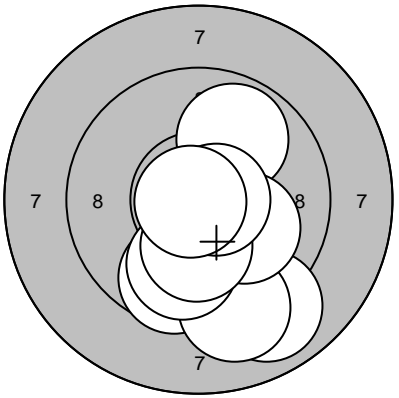
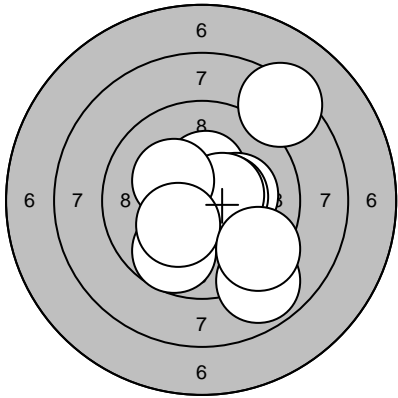
|   |                    |   |              |
|---|--------------------|---|--------------|
| Skjutlag<br><b>3</b>  | Tavla<br><b>24</b> | <b>Maria Kamara</b>   |              |
| STPL  |                    | Bastuträsk  |              |
| 2009-01-17  |                    | Skyttiaden 2009   |              |
| Sight   |                    | Umeå skytteallians  |              |
|    | 1: 10,0 ↗          |   | 1: 9,7 ↓     |
|   | 2: 10,9* ↖         |   | 2: 10,1 ↗    |
|   | 3: 10,3* ↓         |   | 3: 9,8 →     |
|   | 4: 10,5* ↓         |   | 4: 9,2 ↘     |
|   |                    |   | 5: 9,4 →     |
|   |                    |   | 6: 9,2 ↖     |
|   |                    |   | 7: 10,3* →   |
|   |                    |   | 8: 10,1 ↑    |
|   |                    |   | 9: 9,8 ↗     |
|   |                    |   | 10: 9,8 →    |
|   | Serie 40,0         |   | Serie 93,0   |
|   | Totalt 0,0         |   | Totalt 93,0  |
|   | 11: 9,6 →          |  | 21: 9,6 ↓    |
|   | 12: 9,2 ↘          |   | 22: 8,9 ↓    |
|   | 13: 10,5* ↗        |   | 23: 10,0 ↓   |
|   | 14: 9,8 ↓          |   | 24: 9,2 ↓    |
|   | 15: 9,5 ↘          |   | 25: 9,9 ↓    |
|   | 16: 10,2* ↗        |   | 26: 9,9 ↗    |
|   | 17: 10,7* ↘        |   | 27: 10,1 ↘   |
|   | 18: 10,3* ↓        |   | 28: 10,2* ↓  |
|   | 19: 8,7 →          |   | 29: 10,7* →  |
|   | 20: 7,9 ↓          |   | 30: 10,8* ↖  |
|   | Serie 91,0         |   | Serie 94,0   |
|   | Totalt 184,0       |   | Totalt 278,0 |
|  | 31: 10,4* ↑        |   |              |
|   | 32: 9,7 ↓          |   |              |
|   | 33: 8,3 ↗          |   |              |
|   | 34: 10,2* →        |   |              |
|   | 35: 10,4* →        |   |              |
|   | 36: 10,5* →        |   |              |
|   | 37: 10,2* ↗        |   |              |
|   | 38: 10,2* ↖        |   |              |
|   | 39: 8,9 ↓          |   |              |
|   | 40: 9,4 ↘          |   |              |
|   | Serie 94,0         |   |              |
|   | Totalt 372,0       |   |              |

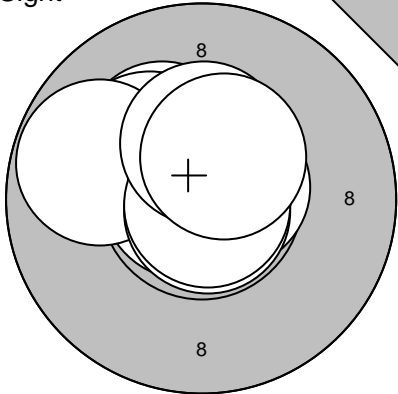
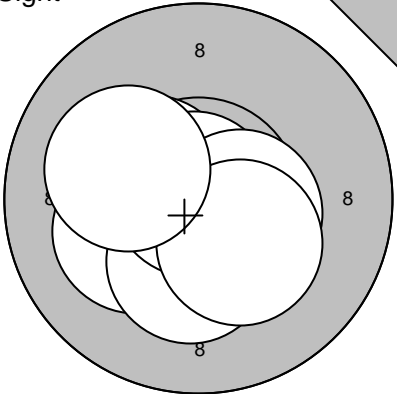
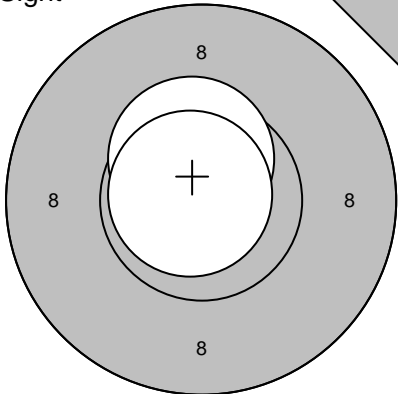
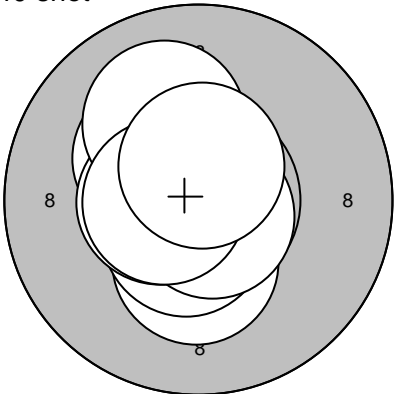
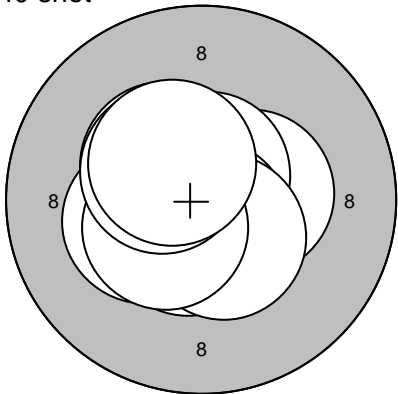
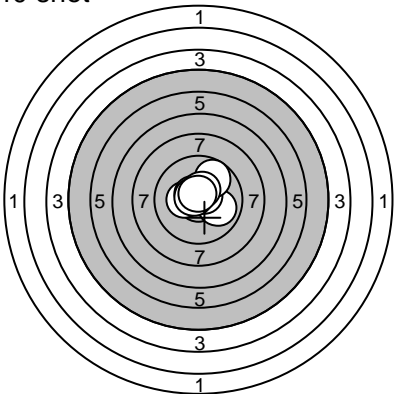
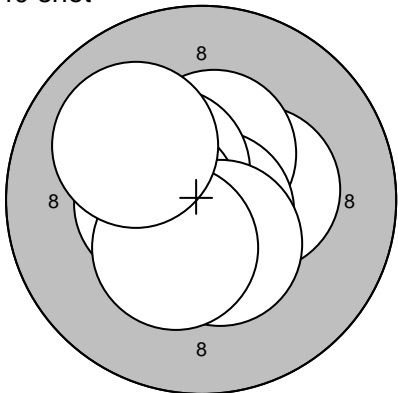
|                 |   |   |         |  |  |
|-----------------|---|---|---------|--|--|
| Skjutlag        | Tavla   | <b>Josefin Adolfsson</b>  |         |  |  |
| <b>3</b>        | <b>25</b>   |   |         |  |  |
| STPL            | Umeå  |   |         |  |  |
| 2009-01-17      | Skyttiaden 2009   | Umeå skytteallians  |         |  |  |
| Sight           |    | 1: 10,6* →<br>2: 10,8* ←<br>3: 10,2* ↗<br>4: 10,2* ↗<br>5: 9,8 ←<br>6: 10,7* ↗<br>7: 10,8* ↓<br>8: 10,9* ↓<br>9: 10,4* ↑<br>10: 10,4* ↗<br>Serie 99,0<br>Totalt 0,0               | Sight   |    | 11: 10,6* ↓<br>12: 10,4* ←<br>13: 10,4* ↗<br>14: 10,7* ←<br>15: 10,2* ←<br>16: 10,3* ↓<br>17: 10,9* ↗<br>18: 10,5* ↓<br>19: 10,3* ↓<br>20: 10,1 ↗<br>Serie 100,0<br>Totalt 0,0 |
| Sight           |   | 21: 10,5* ↑<br>22: 10,8* ↗<br>Serie 20,0<br>Totalt 0,0  | 40 shot |   | 1: 10,3* ↓<br>2: 10,3* ↗<br>3: 10,7* ↗<br>4: 10,5* ↓<br>5: 10,9* ↓<br>6: 10,5* ←<br>7: 10,1 ↗<br>8: 10,7* ↓<br>9: 10,6* ←<br>10: 10,6* ↑<br>Serie 100,0<br>Totalt 100,0        |
| 40 shot         |  | 11: 10,4* ↗<br>12: 10,4* →<br>13: 10,7* ↑<br>14: 10,6* ↓<br>15: 10,7* ↓<br>16: 10,3* ←<br>17: 10,5* ↓<br>18: 10,5* ←<br>19: 10,4* ↗<br>20: 10,4* ↗<br>Serie 100,0<br>Totalt 200,0 | 40 shot |  | 21: 10,3* ←<br>22: 10,7* →<br>23: 10,0 →<br>24: 1,0 ↓<br>25: 10,6* ↗<br>26: 10,6* ↗<br>27: 9,8 ↗<br>28: 10,7* ↗<br>29: 10,4* ↑<br>30: 10,7* ↑<br>Serie 90,0<br>Totalt 290,0    |
| 40 shot         |  | 31: 10,6* ↓<br>32: 10,3* →<br>33: 10,5* ↗<br>34: 10,4* ↑<br>35: 10,8* ↓<br>36: 10,5* ↗<br>37: 10,5* ←<br>38: 10,4* ↓<br>39: 10,4* ↓<br>40: 10,0 ↗<br>Serie 100,0<br>Totalt 390,0  |         |  |  |
| <b>Umeå skf</b> |   |   |         |  |  |

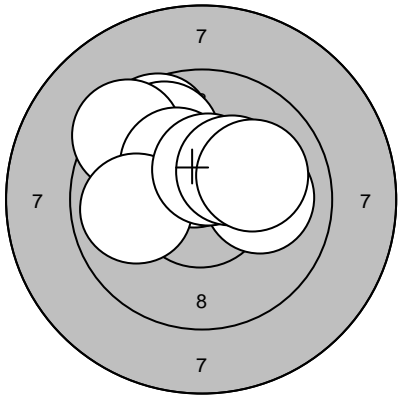
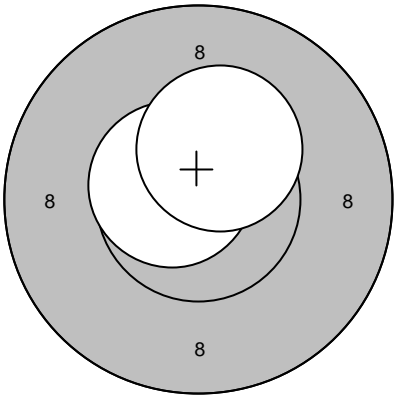
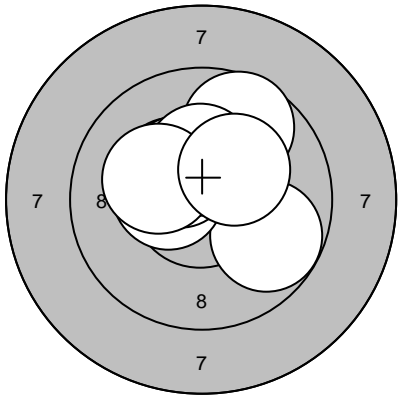
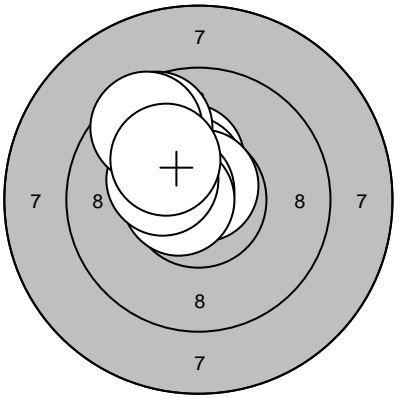
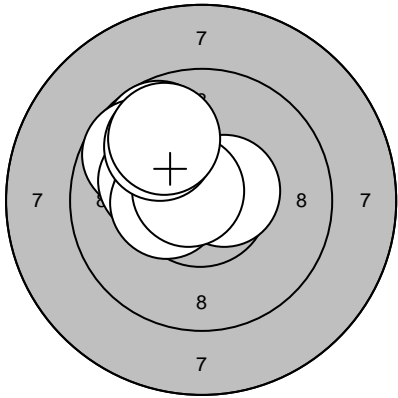
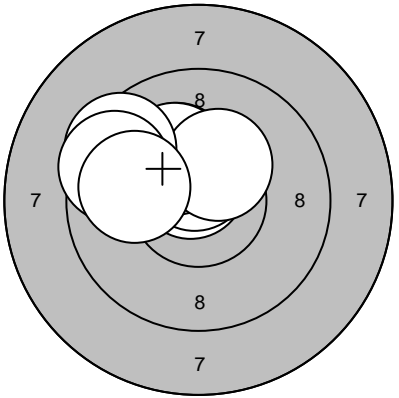

| Skjutlag   | Tavla   | Jeff Holmlund  |   |
|------------|---|--|---|
| 3          | 26  |  |   |
| STPL       | Rönnskär  |  |   |
| 2009-01-17 | Skyttiaden 2009   | Umeå skytteallians   |   |
| Sight      |    | 1: 9,6 ↗<br>2: 9,8 ↗<br>3: 9,4 ↗<br>4: 10,5* ↗<br>5: 10,3* ↗<br>6: 10,0 →<br>7: 9,9 ←<br>8: 10,5* ↗<br>9: 10,3* ↗<br>10: 10,0 →          | Sight<br>   |
|            | Serie 96,0  |  | 11: 10,6* ↖<br>12: 10,4* ↗  |
|            | Totalt 0,0  |  | Serie 20,0  |
|            |   |  | Totalt 0,0  |
| 40 shot    |   | 1: 10,5* ↗<br>2: 10,5* ↗<br>3: 9,6 ↗<br>4: 9,8 →<br>5: 10,4* ↗<br>6: 10,4* ←<br>7: 10,4* ↗<br>8: 10,3* ↗<br>9: 10,2* ↖<br>10: 10,3* ↗    | 40 shot<br>  |
|            | Serie 98,0  |  | 11: 10,3* ↗<br>12: 10,3* ↗<br>13: 10,5* ↗<br>14: 10,7* ↗<br>15: 10,6* ↖<br>16: 9,6 ↗<br>17: 10,6* ←<br>18: 10,3* ↖<br>19: 9,6 ↗<br>20: 10,1 ↗ |
|            | Totalt 98,0   |  | Serie 98,0  |
|            |   |  | Totalt 196,0  |
| 40 shot    |  | 21: 9,8 ↗<br>22: 9,7 ↗<br>23: 9,7 ↗<br>24: 10,2* ↖<br>25: 10,4* ↖<br>26: 10,4* ←<br>27: 10,6* →<br>28: 10,7* ↗<br>29: 9,9 ↗<br>30: 9,8 ↗ | 40 shot<br>   |
|            | Serie 95,0  |  | 31: 10,0 ↖<br>32: 10,7* ↗<br>33: 10,2* ↗<br>34: 9,9 ↖<br>35: 10,5* ↗<br>36: 10,2* ↗<br>37: 10,3* ↗<br>38: 9,5 ↖<br>39: 9,5 ↖<br>40: 9,9 ←     |
|            | Totalt 291,0  |  | Serie 96,0  |
|            |   |  | Totalt 387,0  |
| Umeå skf   |   |  |   |

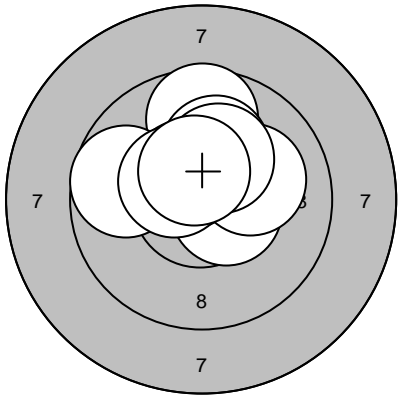
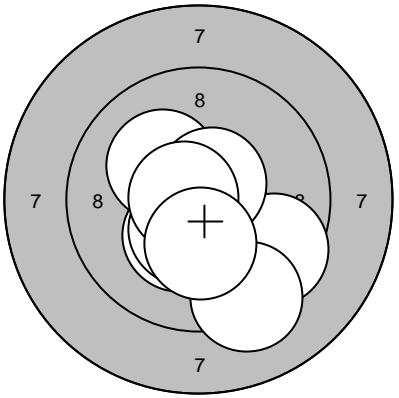
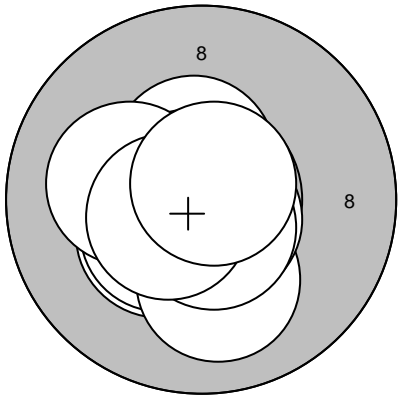
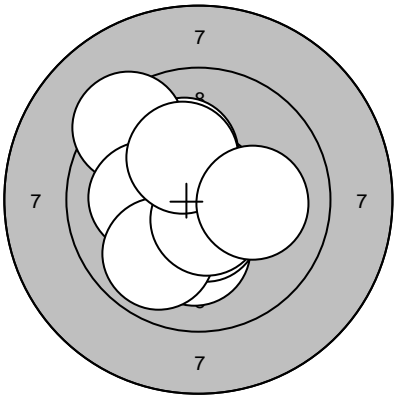
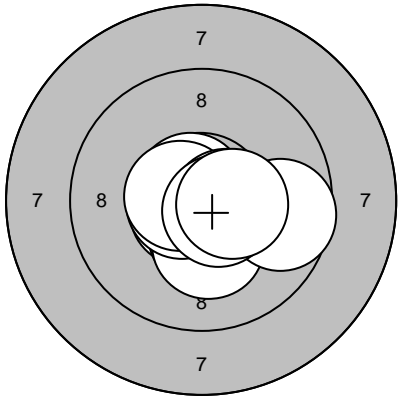
|   |   |   |  |
|---|---|---|--|
| Skjutlag  | Tavla   | <b>Alexander Karlsson Bjerkevall</b>  |  |
| <b>3</b>  | <b>27</b>   |   |  |
| STPL  | Bastuträsk  |   |  |
| 2009-01-17  | Skyttiaden 2009   | Umeå skytteallians  |  |
| Sight   |   | 40 shot   |  |
|    | 1: 10,5* →<br>2: 9,7 ↑<br>3: 10,2* ↑<br>4: 10,3* ↗<br>5: 9,7 ←<br>6: 10,5* ↗<br>7: 10,1 →<br>8: 10,5* ↖<br>9: 10,3* ↗<br>10: 10,5* ↑              |   | 1: 10,9* →<br>2: 10,2* ↖<br>3: 10,8* ↓<br>4: 9,5 ↘<br>5: 10,3* ↓<br>6: 10,6* ↗<br>7: 10,4* ↓<br>8: 10,7* ←<br>9: 9,2 ↓<br>10: 10,3* ↓        |
|   | Serie 98,0  |   | Serie 98,0   |
|   | Totalt 0,0  |   | Totalt 98,0  |
| 40 shot   |   | 40 shot   |  |
|   | 11: 10,4* ↙<br>12: 10,4* ↙<br>13: 10,1 ↓<br>14: 10,7* ↘<br>15: 10,5* ↑<br>16: 10,6* ↓<br>17: 10,8* ↖<br>18: 10,2* ←<br>19: 10,5* ↙<br>20: 10,7* ↗ |  | 21: 10,2* ↑<br>22: 10,2* ↓<br>23: 9,4 ↗<br>24: 10,5* ↓<br>25: 10,8* ↓<br>26: 10,1 ←<br>27: 9,9 ↙<br>28: 10,6* ↓<br>29: 10,3* ↑<br>30: 10,1 → |
|   | Serie 100,0   |   | Serie 98,0   |
|   | Totalt 198,0  |   | Totalt 296,0   |
| 40 shot   |   |   |  |
|  | 31: 10,6* ↙<br>32: 10,4* ↓<br>33: 10,7* ↗<br>34: 10,2* ↓<br>35: 10,6* ←<br>36: 10,6* ←<br>37: 10,5* →<br>38: 9,7 →<br>39: 10,6* ↓<br>40: 10,4* →  |   |  |
|   | Serie 99,0  |   |  |
|   | Totalt 395,0  |   |  |

Umeå skf

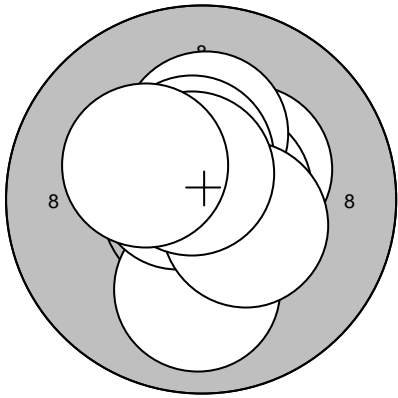
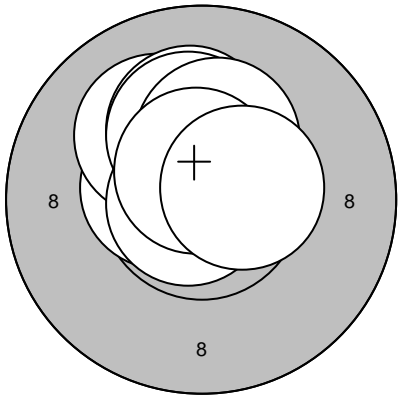
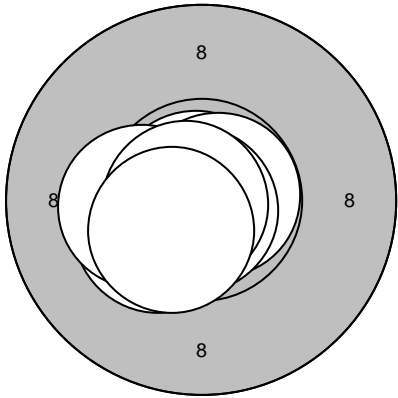
|                      |   |  |                    |
|----------------------|---|--|--------------------|
| Skjutlag<br><b>3</b> | Tavla<br><b>29</b>  | <b>Johanna Adelsson</b>  |                    |
| STPL                 |   | Ramselefors  |                    |
| 2009-01-17           |   | Skyttiaden 2009  | Umeå skytteallians |
| Sight                |    | 1: 10,7* ↑<br>2: 10,3* ↗<br>3: 10,6* →<br>4: 10,2* ↑<br>5: 10,0 ↓<br>6: 10,5* ↑<br>7: 10,7* ↖<br>8: 10,4* ↘<br>9: 10,7* ↑<br>10: 10,3* ↖         | Sight              |
|                      |   | Serie 100,0  | 11: 10,5* ↗        |
|                      |   | Totalt 0,0   | Serie 10,0         |
|                      |   |  | Totalt 0,0         |
| 40 shot              |   | 1: 10,3* ↑<br>2: 10,7* ↑<br>3: 10,5* ←<br>4: 10,1 ↗<br>5: 10,2* ↑<br>6: 10,3* ↑<br>7: 10,8* ←<br>8: 10,3* ↑<br>9: 10,6* ↑<br>10: 10,5* →         | 40 shot            |
|                      |   | Serie 100,0  | 11: 10,3* →        |
|                      |   | Totalt 100,0   | 12: 10,1 ←         |
|                      |   |  | 13: 10,4* ←        |
|                      |   |  | 14: 10,5* ←        |
|                      |   |  | 15: 10,5* ↗        |
|                      |   |  | 16: 10,5* ↘        |
|                      |   |  | 17: 10,4* ←        |
|                      |   |  | 18: 10,9* ←        |
|                      |   |  | 19: 9,7 ←          |
|                      |   |  | 20: 10,2* ←        |
|                      |   | Serie 99,0   |                    |
|                      |   | Totalt 199,0   |                    |
| 40 shot              |  | 21: 10,7* ↙<br>22: 10,4* ←<br>23: 10,4* ↙<br>24: 10,9* ↖<br>25: 10,3* ←<br>26: 0,0 ↘<br>27: 10,8* →<br>28: 10,8* ↙<br>29: 10,8* ←<br>30: 10,5* ↙ | 40 shot            |
|                      |   | Serie 90,0   | 31: 10,7* →        |
|                      |   | Totalt 289,0   | 32: 10,6* ↘        |
|                      |   |  | 33: 10,8* ←        |
|                      |   |  | 34: 10,6* →        |
|                      |   |  | 35: 10,7* ↑        |
|                      |   |  | 36: 10,3* ←        |
|                      |   |  | 37: 10,7* ↗        |
|                      |   |  | 38: 10,4* ↙        |
|                      |   |  | 39: 10,6* ↘        |
|                      |   |  | 40: 10,7* ←        |
|                      |   | Serie 100,0  |                    |
|                      |   | Totalt 389,0   |                    |

Umeå skf

|                      |                    |                     |             |
|----------------------|--------------------|---------------------|-------------|
| Skjutlag<br><b>3</b> | Tavla<br><b>30</b> | <b>Anna Viklund</b> |             |
| STPL                 |                    | Bastuträsk          |             |
| 2009-01-17           |                    | Skyttiaden 2009     |             |
| Sight                |                    | Sight               |             |
|                      | 1: 10,7* ↖         |                     |             |
|                      | 2: 10,6* ↗         |                     |             |
|                      | 3: 10,3* ↗         |                     |             |
|                      | 4: 10,8* ↖         |                     |             |
| 5: 10,4* ↗           | 11: 10,5* ↘        |                     |             |
| 6: 10,5* ↗           | 12: 10,5* ↙        |                     |             |
| 7: 10,4* ↗           | 13: 10,6* ↓        |                     |             |
| 8: 10,6* ←           |                    |                     |             |
| 9: 10,6* ↙           |                    |                     |             |
| 10: 10,1 ↘           |                    |                     |             |
| Serie 100,0          | Serie 30,0         |                     |             |
| Totalt 0,0           | Totalt 0,0         |                     |             |
| 40 shot              | 40 shot            | 40 shot             | 40 shot     |
|                      | 1: 10,6* ↓         |                     |             |
|                      | 2: 9,9 ↓           |                     |             |
|                      | 3: 10,4* →         |                     |             |
|                      | 4: 10,5* ↓         |                     |             |
|                      | 5: 10,8* ↓         |                     |             |
|                      | 6: 9,6 →           |                     |             |
|                      | 7: 10,6* ↑         |                     |             |
|                      | 8: 10,2* →         |                     |             |
|                      | 9: 10,4* →         |                     |             |
|                      | 10: 10,1 ↓         |                     |             |
|                      | Serie 98,0         |                     | Serie 100,0 |
| Totalt 98,0          | Totalt 198,0       |                     |             |
| 40 shot              | 40 shot            | 40 shot             | 40 shot     |
|                      | 21: 10,6* ↘        |                     |             |
|                      | 22: 10,2* ↗        |                     |             |
|                      | 23: 10,4* ↗        |                     |             |
|                      | 24: 10,2* ↙        |                     |             |
|                      | 25: 9,9 ↘          |                     |             |
|                      | 26: 10,6* ↗        |                     |             |
|                      | 27: 10,8* →        |                     |             |
|                      | 28: 10,4* ↗        |                     |             |
|                      | 29: 10,4* ↙        |                     |             |
|                      | 30: 10,7* ↓        |                     |             |
|                      | Serie 99,0         |                     | Serie 99,0  |
| Totalt 297,0         | Totalt 396,0       |                     |             |

Umeå skf

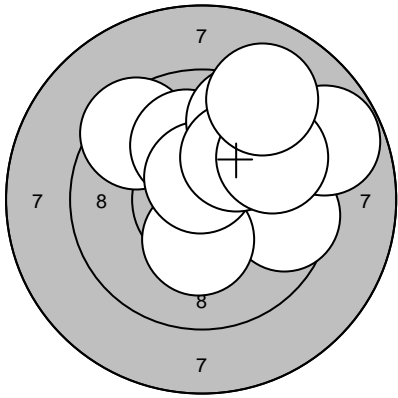
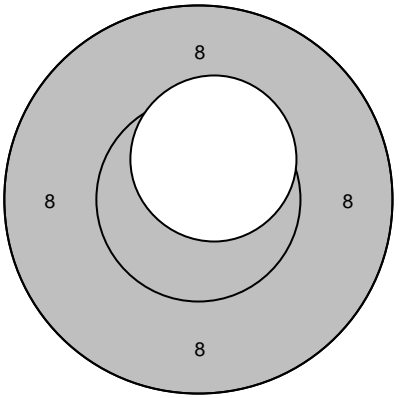
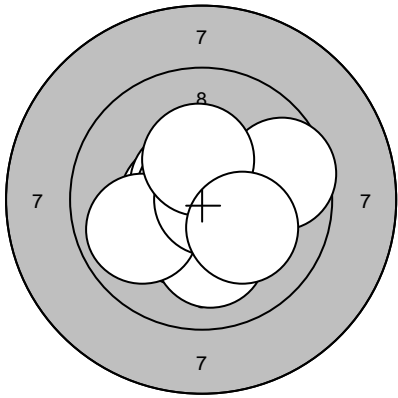
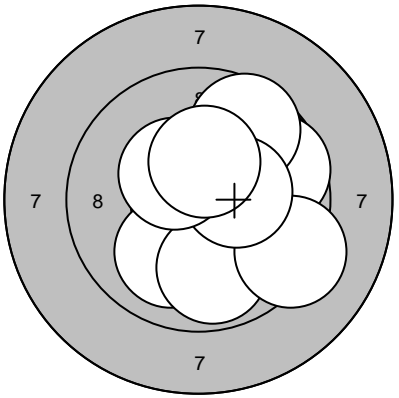
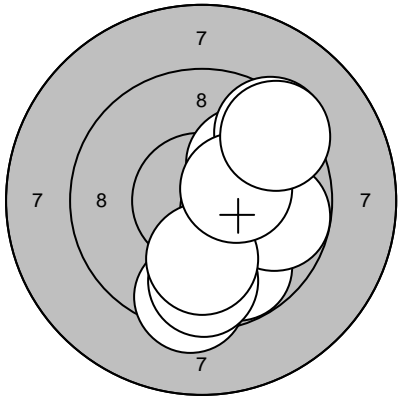
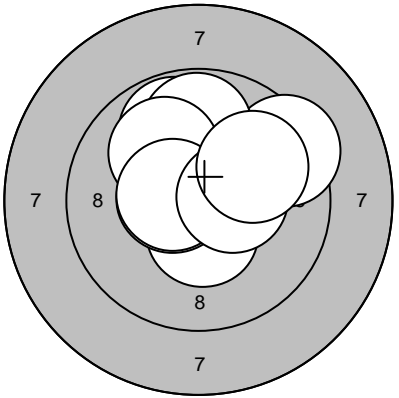
| Skjutlag   | Tavla   | Emma Eriksson  |   |
|------------|---|--|---|
| 3          | 31  |  |   |
| STPL       | Bjurholm-Balsjö   |  |   |
| 2009-01-17 | Skyttiaden 2009   | Umeå skytteallians   |   |
| Sight      |    | 1: 9,5 ↖<br>2: 9,6 →<br>3: 10,3* ↓<br>4: 10,1 ↑<br>5: 8,8 →<br>6: 10,6* ↑<br>7: 9,5 ↗<br>8: 10,1 ↗<br>9: 9,6 ↗<br>10: 9,1 ↗<br>Serie 93,0<br>Totalt 0,0            | Sight<br>   |
|            |   |  | 11: 10,5* ↑<br>Serie 10,0<br>Totalt 0,0   |
| 40 shot    |   | 1: 10,6* ←<br>2: 10,6* ↗<br>3: 10,4* ↘<br>4: 10,8* ↗<br>5: 10,1 ↓<br>6: 9,9 ←<br>7: 10,8* →<br>8: 9,6 →<br>9: 10,3* ↑<br>10: 10,1 ↘<br>Serie 98,0<br>Totalt 98,0   | 40 shot<br>  |
|            |   |  | 11: 10,0 ↘<br>12: 9,9 ↘<br>13: 9,8 ↗<br>14: 9,8 ↓<br>15: 9,6 →<br>16: 9,6 ↗<br>17: 9,3 ↘<br>18: 10,3* →<br>19: 10,4* ↖<br>20: 10,4* ↑<br>Serie 94,0<br>Totalt 192,0     |
| 40 shot    |  | 21: 10,1 ↗<br>22: 9,4 ↗<br>23: 10,4* →<br>24: 9,8 ↓<br>25: 9,4 ↓<br>26: 9,8 →<br>27: 9,7 ↓<br>28: 10,0 ↓<br>29: 10,4* →<br>30: 9,4 ↗<br>Serie 94,0<br>Totalt 286,0 | 40 shot<br>   |
|            |   |  | 31: 9,4 ↗<br>32: 10,8* ↖<br>33: 9,8 ↑<br>34: 10,4* ↓<br>35: 9,8 ↑<br>36: 10,0 ↗<br>37: 10,5* ←<br>38: 10,5* ←<br>39: 10,4* →<br>40: 9,9 ↗<br>Serie 96,0<br>Totalt 382,0 |
| Umeå skf   |   |  |   |

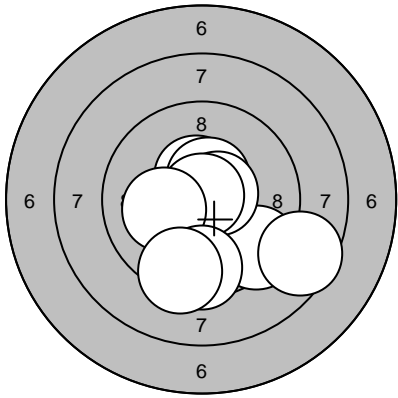
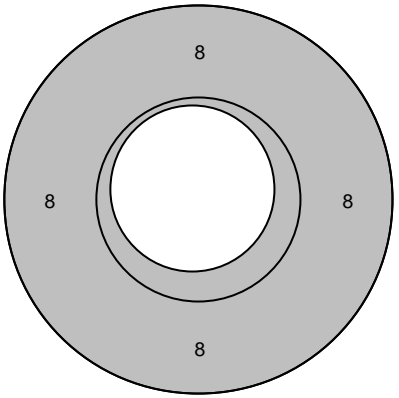
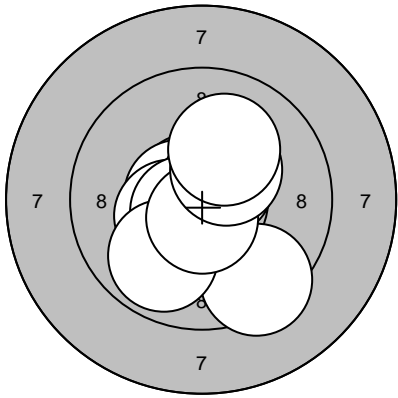
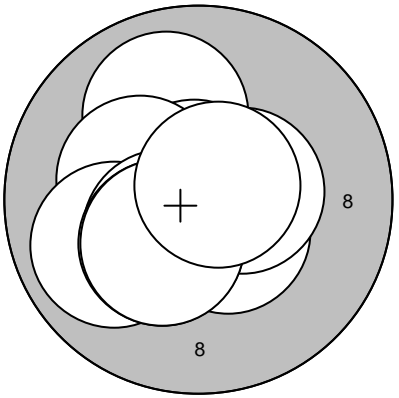
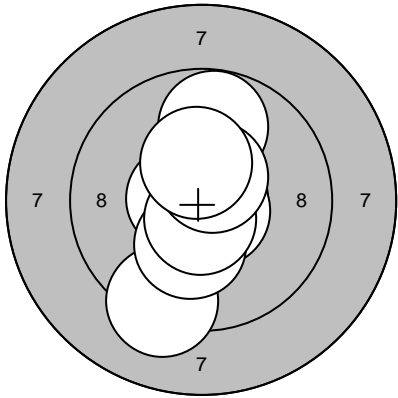
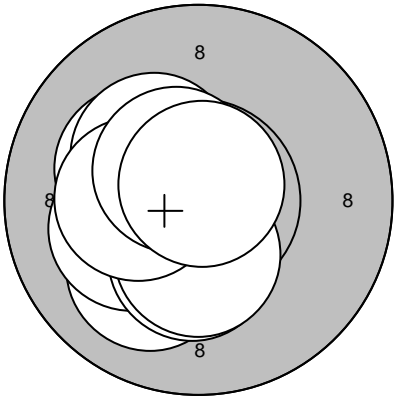
| Skjutlag   | Tavla   | Emmy Ahlgren-Jonsson   |   |
|------------|---|--|---|
| STPL       | Ramselefors   |  |   |
| 2009-01-17 | Skyttiaden 2009   | Umeå skytteallians   |   |
| Sight      |    | 1: 9,4 ↘<br>2: 8,6 →<br>3: 10,5* ↑<br>4: 10,6* ↗<br>5: 10,5* ↑<br>6: 10,6* →<br>7: 10,9* ↗<br>8: 10,2* ←<br>9: 9,5 ↓<br>10: 9,4 ↓<br>Serie 95,0<br>Totalt 0,0                | Sight<br>     |
|            |   |  | 11: 10,8* ↗   |
|            |   |  | Serie 10,0  |
|            |   |  | Totalt 0,0  |
| 40 shot    |   | 1: 10,7* ↗<br>2: 10,6* ←<br>3: 10,4* ←<br>4: 9,4 ↓<br>5: 10,6* ↗<br>6: 10,6* ←<br>7: 9,9 ↓<br>8: 10,6* ↓<br>9: 10,4* ↗<br>10: 10,1 ↗<br>Serie 98,0<br>Totalt 98,0            | 40 shot<br>  |
|            |   |  | 11: 10,5* ↘   |
|            |   |  | 12: 10,0 ↗  |
|            |   |  | 13: 10,5* →   |
|            |   |  | 14: 10,8* ↑   |
|            |   |  | 15: 10,3* ←   |
|            |   |  | 16: 9,9 ←   |
|            |   |  | 17: 10,4* ↘   |
|            |   |  | 18: 10,3* ↘   |
|            |   |  | 19: 10,3* ↘   |
|            |   |  | 20: 10,7* ↗   |
|            |   |  | Serie 99,0  |
|            |   |  | Totalt 197,0  |
| 40 shot    |  | 21: 10,7* ←<br>22: 10,9* →<br>23: 10,7* ←<br>24: 9,2 ↓<br>25: 10,7* ↘<br>26: 10,2* ↓<br>27: 9,8 ↑<br>28: 10,6* ↓<br>29: 10,5* ↗<br>30: 10,4* ↑<br>Serie 98,0<br>Totalt 295,0 | 40 shot<br> |
|            |   |  | 31: 10,0 ↘  |
|            |   |  | 32: 10,2* ↗   |
|            |   |  | 33: 10,5* ←   |
|            |   |  | 34: 10,2* ←   |
|            |   |  | 35: 10,3* ↓   |
|            |   |  | 36: 10,4* ↓   |
|            |   |  | 37: 10,3* ↗   |
|            |   |  | 38: 10,3* ←   |
|            |   |  | 39: 10,5* ↗   |
|            |   |  | 40: 10,8* ↑   |
|            |   |  | Serie 100,0   |
|            |   |  | Totalt 395,0  |
| Umeå skf   |   |  |   |

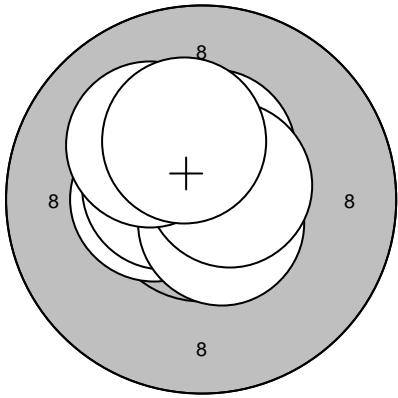
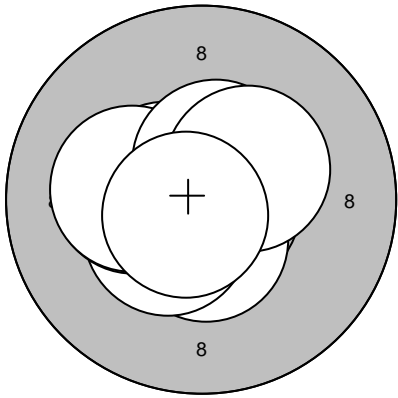
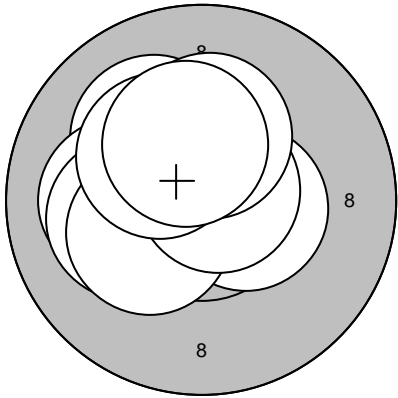
| Skjutlag   | Tavla   | Johanna Renberg  |  |
|------------|---|--|--|
| 3          | 33  |  |  |
| STPL       | Rönnskär  |  |  |
| 2009-01-17 | Skyttiden 2009  | Umeå skytteallians   |  |
| Sight      |    | 1: 10,5* ←<br>2: 10,4* ↑<br>3: 10,3* ↑<br>4: 10,4* ←<br>5: 10,5* ←<br>6: 10,6* ↓<br>7: 10,4* ↑<br>8: 10,6* →<br>9: 10,1 ↑<br>10: 10,3* ↑         | Sight  |
|            | Serie 100,0<br>Totalt 0,0   |  | 11: 10,3* ↓<br>12: 10,8* ↓<br>13: 10,4* ←<br>14: 10,6* ↗   |
|            |   |  | Serie 40,0<br>Totalt 0,0   |
| 40 shot    |   | 1: 10,5* ←<br>2: 10,5* ↓<br>3: 10,8* ↑<br>4: 10,4* ←<br>5: 10,2* ←<br>6: 10,8* ↑<br>7: 10,2* ←<br>8: 10,5* ↑<br>9: 10,4* →<br>10: 10,7* ↙        | 40 shot  |
|            | Serie 100,0<br>Totalt 100,0   |  | 11: 10,2* ←<br>12: 10,2* ↖<br>13: 10,7* ←<br>14: 10,3* ↓<br>15: 10,8* ↗<br>16: 10,3* ←<br>17: 10,7* ↑<br>18: 9,9 ↑<br>19: 10,6* ↗<br>20: 10,6* ← |
|            |   |  | Serie 99,0<br>Totalt 199,0   |
| 40 shot    |  | 21: 10,6* ↗<br>22: 10,1 ↗<br>23: 10,1 ←<br>24: 10,5* →<br>25: 10,2* ←<br>26: 10,3* ←<br>27: 10,7* →<br>28: 10,3* ↑<br>29: 10,3* ↗<br>30: 10,3* ↑ | 40 shot  |
|            | Serie 100,0<br>Totalt 299,0   |  | 31: 10,8* →<br>32: 10,1 ←<br>33: 10,5* ↑<br>34: 10,4* ←<br>35: 10,7* ↓<br>36: 10,7* ↗<br>37: 10,5* ←<br>38: 10,1 ←<br>39: 10,5* ↑<br>40: 10,6* ↓ |
|            |   |  | Serie 100,0<br>Totalt 399,0  |

Umeå skf

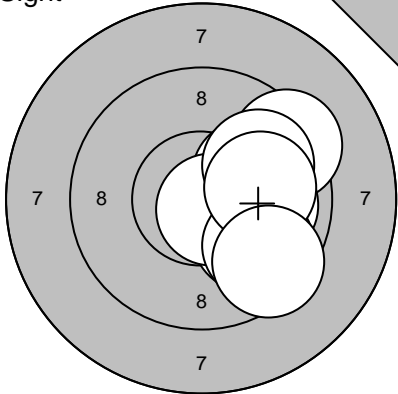
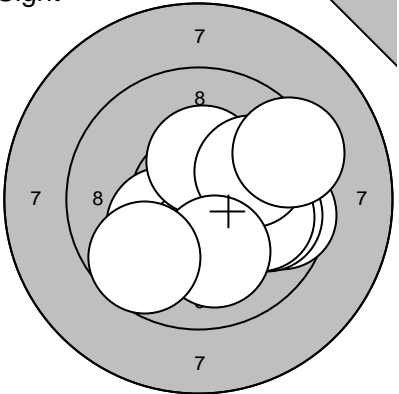
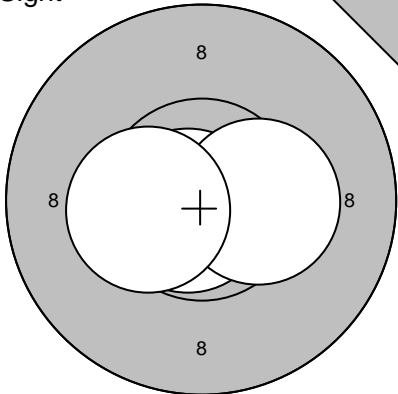
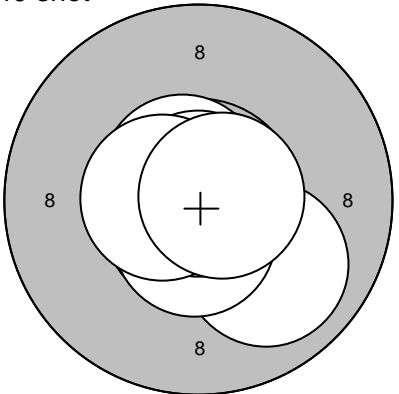
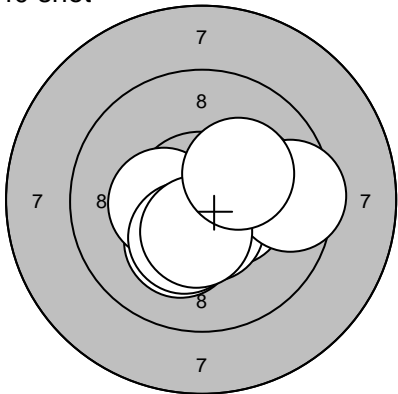
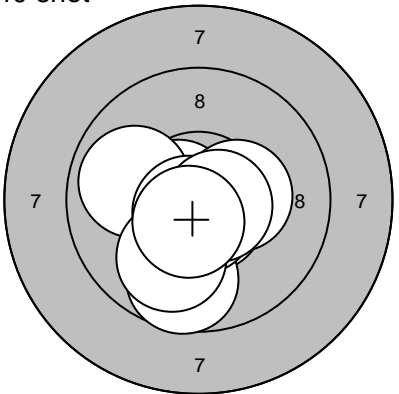
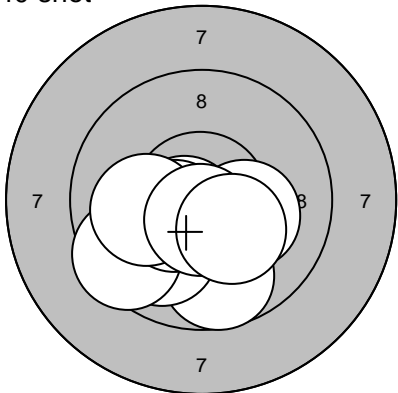
|  |  |   |   |
|--|--|---|---|
| Skjutlag<br><b>3</b>   | Tavla<br><b>35</b>   | <b>Linnea Hansson</b>   |   |
| STPL   |  | Gumboda/Ånäset  |   |
| 2009-01-17   |  | Skyttiaden 2009   | Umeå skytteallians  |
| Sight<br>     | 1: 10,0 ↘<br>2: 10,1 →<br>3: 9,4 →<br>4: 10,0 →<br>5: 10,0 →<br>6: 10,7* ↘<br>7: 9,8 ↘<br>8: 9,9 →<br>9: 10,0 →<br>10: 9,5 ↘<br>Serie 96,0<br>Totalt 0,0                       | Sight<br>     | 11: 9,6 →<br>12: 9,8 →<br>13: 10,2* ↙<br>14: 10,0 →<br>15: 10,3* ↓<br>16: 10,3* ↑<br>17: 10,0 →<br>18: 10,1 ↓<br>19: 9,7 ↙<br>20: 9,3 →<br>Serie 96,0<br>Totalt 0,0         |
| Sight<br>    | 21: 10,8* ↙<br>22: 10,3* →<br>23: 10,4* ←<br>Serie 30,0<br>Totalt 0,0  | 40 shot<br>  | 1: 10,0 ↘<br>2: 10,7* ↓<br>3: 10,7* ↓<br>4: 10,6* ↓<br>5: 10,7* ↗<br>6: 10,8* →<br>7: 10,7* ↗<br>8: 10,9* ↑<br>9: 10,6* ←<br>10: 10,7* →<br>Serie 100,0<br>Totalt 100,0     |
| 40 shot<br> | 11: 10,8* ↓<br>12: 10,2* ↓<br>13: 10,3* ←<br>14: 10,3* ↓<br>15: 10,2* →<br>16: 10,5* →<br>17: 10,5* ↓<br>18: 9,5 →<br>19: 10,4* ↓<br>20: 10,2* ↗<br>Serie 99,0<br>Totalt 199,0 | 40 shot<br> | 21: 10,6* ←<br>22: 10,6* ↓<br>23: 10,4* →<br>24: 9,9 ←<br>25: 9,7 ↓<br>26: 10,7* ↓<br>27: 10,7* ↙<br>28: 10,6* →<br>29: 10,0 ↙<br>30: 10,6* ↓<br>Serie 98,0<br>Totalt 297,0 |
| 40 shot<br> | 31: 10,6* ↙<br>32: 9,7 ↓<br>33: 10,2* →<br>34: 10,0 ↙<br>35: 9,9 ↙<br>36: 9,5 ↙<br>37: 10,5* ↙<br>38: 10,1 ←<br>39: 10,6* ↓<br>40: 10,3* ↘<br>Serie 97,0<br>Totalt 394,0       |   |   |
| <b>Umeå skf</b>  |  |   |   |

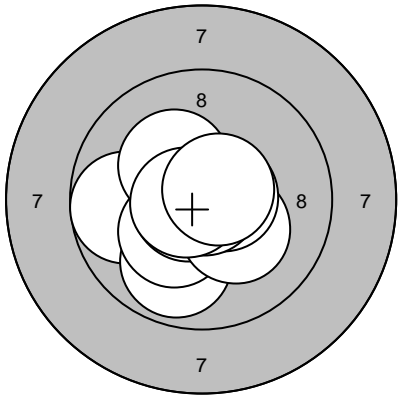
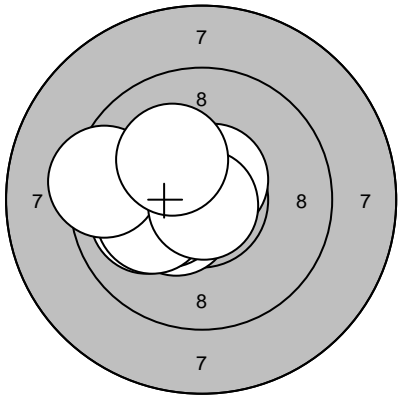
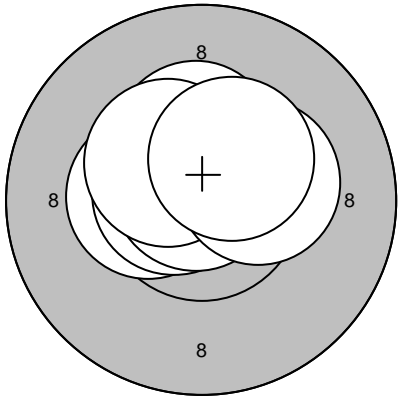

|                      |   |  |                    |
|----------------------|---|--|--------------------|
| Skjutlag<br><b>3</b> | Tavla<br><b>36</b>  | <b>Petra Nilsson</b>   |                    |
| STPL                 |   | Ramselefors  |                    |
| 2009-01-17           |   | Skyttiaden 2009  | Umeå skytteallians |
| Sight                |    | 1: 9,7 ←<br>2: 9,9 ↓<br>3: 10,3* ↓<br>4: 10,3* ↗<br>5: 10,7* ←<br>6: 10,2* ↓<br>7: 10,6* →<br>8: 10,9* →<br>9: 10,7* ←<br>10: 10,6* ↗              | Sight              |
|                      |   | Serie 98,0   | 11: 10,8* →        |
|                      |   | Totalt 0,0   | Serie 10,0         |
|                      |   |  | Totalt 0,0         |
| 40 shot              |   | 1: 10,2* ←<br>2: 10,0 ←<br>3: 10,5* ↓<br>4: 10,4* ←<br>5: 10,0 ←<br>6: 10,1 ←<br>7: 9,4 ←<br>8: 10,6* ↗<br>9: 10,9* ↓<br>10: 10,2* ↗               | 40 shot            |
|                      |   | Serie 99,0   | 11: 10,7* ↗        |
|                      |   | Totalt 99,0  | 12: 10,4* ↑        |
|                      |   |  | 13: 10,5* ↗        |
|                      |   |  | 14: 10,5* ↑        |
|                      |   |  | 15: 9,9 →          |
|                      |   |  | 16: 10,5* ↗        |
|                      |   |  | 17: 10,4* ↗        |
|                      |   |  | 18: 10,6* ↑        |
|                      |   |  | 19: 10,4* ←        |
|                      |   |  | 20: 10,6* ↑        |
|                      |   | Serie 99,0   | Serie 99,0         |
|                      |   | Totalt 99,0  | Totalt 198,0       |
| 40 shot              |  | 21: 10,5* ↑<br>22: 10,7* ↗<br>23: 10,4* ←<br>24: 10,4* ↗<br>25: 10,3* ↑<br>26: 10,7* ←<br>27: 10,8* ↗<br>28: 10,4* ↗<br>29: 10,3* →<br>30: 10,4* ↗ | 40 shot            |
|                      |   | Serie 100,0  | 31: 10,1 ↗         |
|                      |   | Totalt 298,0   | 32: 10,3* ↑        |
|                      |   |  | 33: 10,3* ↑        |
|                      |   |  | 34: 10,1 ↑         |
|                      |   |  | 35: 10,3* ←        |
|                      |   |  | 36: 10,6* ↓        |
|                      |   |  | 37: 10,3* ←        |
|                      |   |  | 38: 10,4* ↓        |
|                      |   |  | 39: 10,0 ↗         |
|                      |   |  | 40: 10,0 ↗         |
|                      |   | Serie 100,0  | Serie 100,0        |
|                      |   | Totalt 298,0   | Totalt 398,0       |
| <b>Umeå skf</b>      |   |  |                    |

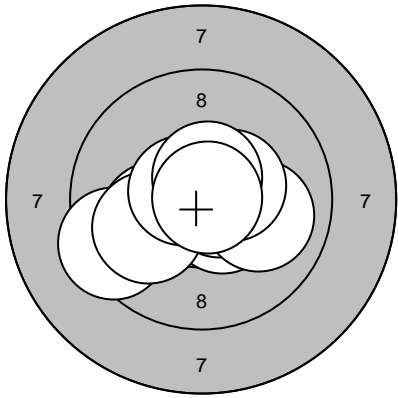
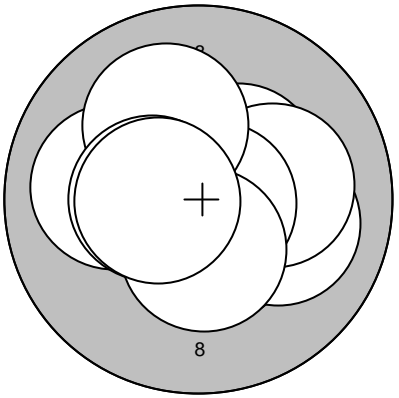
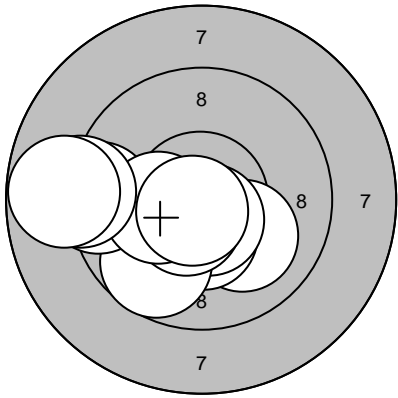
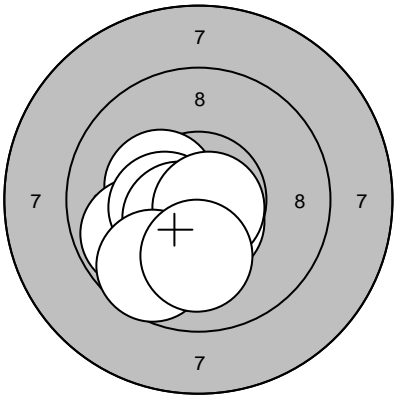
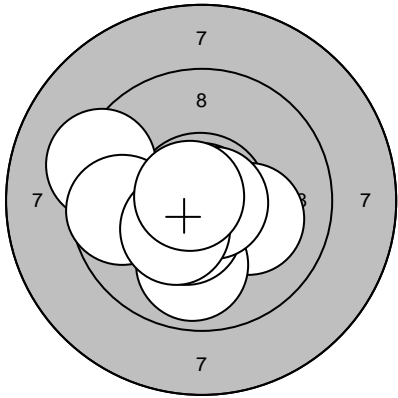
|   |   |   |   |
|---|---|---|---|
| Skjutlag  | Tavla   | <b>Robin Frank</b>  |   |
| <b>3</b>  | <b>38</b>   |   |   |
| STPL  | Ramselefors   |   |   |
| 2009-01-17  | Skyttiaden 2009   | Umeå skytteallians  |   |
| Sight   |   | 40 shot   | 40 shot   |
|    | 1: 9,4 ↙<br>2: 10,2* ←<br>3: 10,5* ↘<br>4: 10,6* →<br>5: 10,0 →<br>6: 10,0 ←<br>7: 10,6* ↖<br>8: 10,4* →<br>9: 10,6* ↗<br>10: 10,8* →       |   | 1: 10,5* ↓<br>2: 10,1 →<br>3: 10,4* ↗<br>4: 10,0 ←<br>5: 10,1 →<br>6: 10,8* →<br>7: 10,1 ↗<br>8: 10,5* ←<br>9: 10,4* ↓<br>10: 10,5* ←       |
|   | Serie 99,0  |   | Serie 100,0   |
|   | Totalt 0,0  |   | Totalt 100,0  |
| 40 shot   |   | 40 shot   |   |
|   | 11: 10,1 ↘<br>12: 10,4* ↓<br>13: 10,6* ↓<br>14: 9,7 ↘<br>15: 10,5* ↘<br>16: 9,3 ←<br>17: 10,3* ←<br>18: 10,7* ↘<br>19: 9,0 ←<br>20: 8,8 ←   |  | 21: 10,6* ↓<br>22: 10,0 ↓<br>23: 10,3* ←<br>24: 10,0 ↘<br>25: 9,8 ←<br>26: 10,4* ←<br>27: 10,5* ↘<br>28: 10,7* ↘<br>29: 9,7 ↘<br>30: 10,1 ↓ |
|   | Serie 95,0  |   | Serie 98,0  |
|   | Totalt 195,0  |   | Totalt 293,0  |
| 40 shot   |   |   |   |
|  | 31: 10,1 →<br>32: 10,3* ↓<br>33: 9,9 ↓<br>34: 9,3 ↖<br>35: 10,9* ↑<br>36: 10,4* ↓<br>37: 10,7* →<br>38: 9,7 ←<br>39: 10,3* ↘<br>40: 10,8* ↖ |   |   |
|   | Serie 97,0  |   |   |
|   | Totalt 390,0  |   |   |

Umeå skf

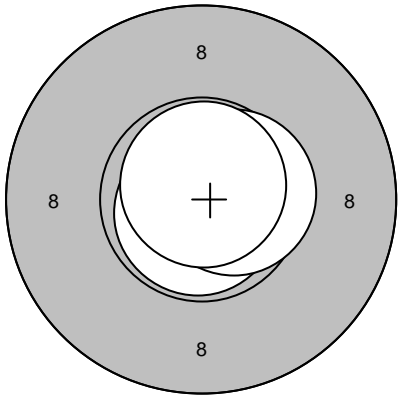
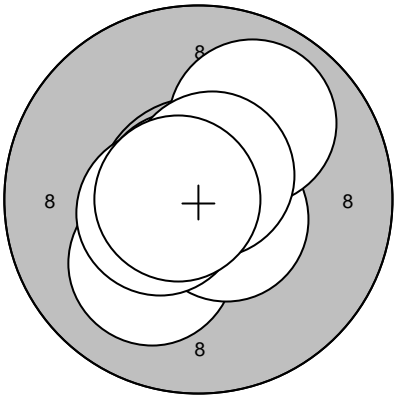
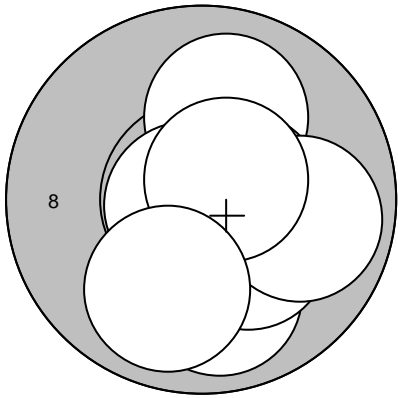
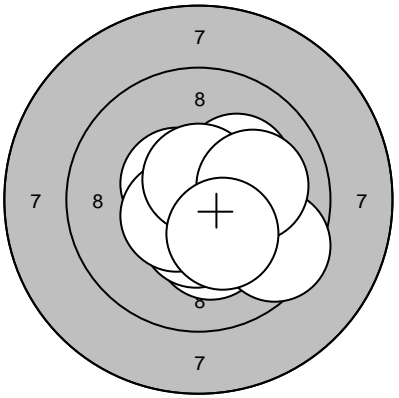
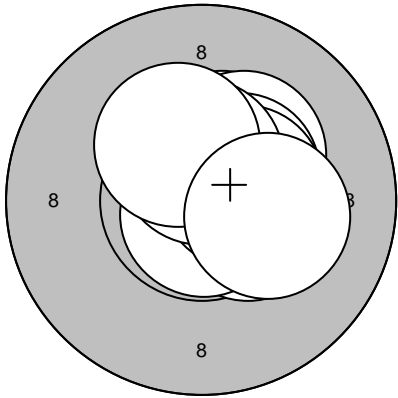
|   |  |   |   |
|---|--|---|---|
| Skjutlag  | Tavla  | William Karlsson  |   |
| 3   | 40   |   |   |
| STPL  | Drängsmark   |   |   |
| 2009-01-17  | Skyttiaden 2009  | Umeå skytteallians  |   |
| Sight   |  | 40 shot   |   |
|    | 1: 10,9* ↓<br>2: 10,8* ↓<br>3: 10,6* →<br>4: 10,8* ↑   |   | 1: 10,8* ←<br>2: 10,7* ↘<br>3: 10,7* ↓<br>4: 10,1 ↘<br>5: 10,8* ←<br>6: 10,6* ↘<br>7: 10,0 ↗<br>8: 10,7* ↗<br>9: 10,5* ←<br>10: 10,7* ←         |
|   | Serie 40,0<br>Totalt 0,0   |   | Serie 100,0<br>Totalt 100,0   |
| 40 shot   |  | 40 shot   |   |
|   | 11: 9,9 ↓<br>12: 10,7* ↘<br>13: 10,0 ↑<br>14: 10,8* ←<br>15: 10,6* →<br>16: 10,5* →<br>17: 10,2* ↘<br>18: 9,9 →<br>19: 10,6* ↗<br>20: 9,9 ↓        |  | 21: 10,5* ↖<br>22: 10,2* ↓<br>23: 10,7* ↓<br>24: 9,5 ↘<br>25: 10,4* ↓<br>26: 10,5* ←<br>27: 10,2* ↗<br>28: 10,6* ↑<br>29: 10,1 →<br>30: 10,3* ↘ |
|   | Serie 97,0<br>Totalt 197,0   |   | Serie 99,0<br>Totalt 296,0  |
| 40 shot   |  |   |   |
|  | 31: 10,5* →<br>32: 10,4* ↑<br>33: 10,4* →<br>34: 10,3* ↗<br>35: 10,5* ↗<br>36: 10,8* ↓<br>37: 10,5* →<br>38: 10,5* ↑<br>39: 10,3* ↗<br>40: 10,2* → |   |   |
|   | Serie 100,0<br>Totalt 396,0  |   |   |

Umeå skf

|            |                 |                    |   |       |
|------------|-----------------|--------------------|---|-------|
| Skjutlag   | Tavla           | Johanna Nilsson    |   |       |
| 4          | 21              |                    |   |       |
| STPL       | Ramselefors     |                    |   |       |
| 2009-01-17 | Skyttiaden 2009 | Umeå skytteallians |   |       |
| Sight      |                 | 1: 9,6             | ↓ |       |
|            |                 | 2: 9,9             | ↓ |       |
|            |                 | 3: 10,0            | ↓ |       |
|            |                 | 4: 10,8*           | ↗ |       |
|            |                 | 5: 10,8*           | ↗ |       |
|            |                 | 6: 10,7*           | ↙ |       |
|            |                 | 7: 10,1            | ↘ |       |
|            |                 | 8: 10,1            | ↖ |       |
|            |                 | 9: 10,6*           | ↑ |       |
|            |                 | 10: 10,4*          | ↖ |       |
|            |                 | Serie              |   | 103,0 |
| Totalt     |                 | 0,0                |   |       |
| Sight      |                 | 11: 10,9*          | ↖ |       |
|            |                 | Serie              |   | 10,9  |
|            |                 | Totalt             |   | 0,0   |
| 40 shot    |                 | 1: 10,8*           | ↖ |       |
|            |                 | 2: 10,5*           | ↑ |       |
|            |                 | 3: 10,8*           | ← |       |
|            |                 | 4: 9,9             | ↑ |       |
|            |                 | 5: 10,2*           | ↖ |       |
|            |                 | Serie              |   | 52,2  |
| Totalt     |                 | 52,2               |   |       |
| Umeå skf   |                 |                    |   |       |

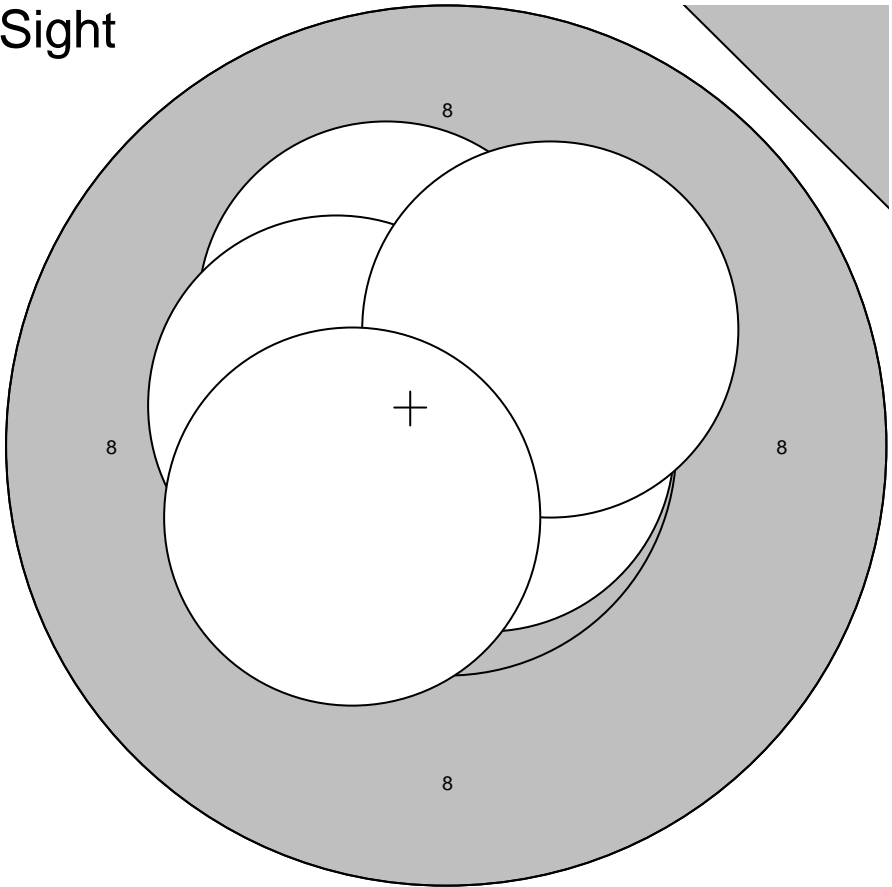
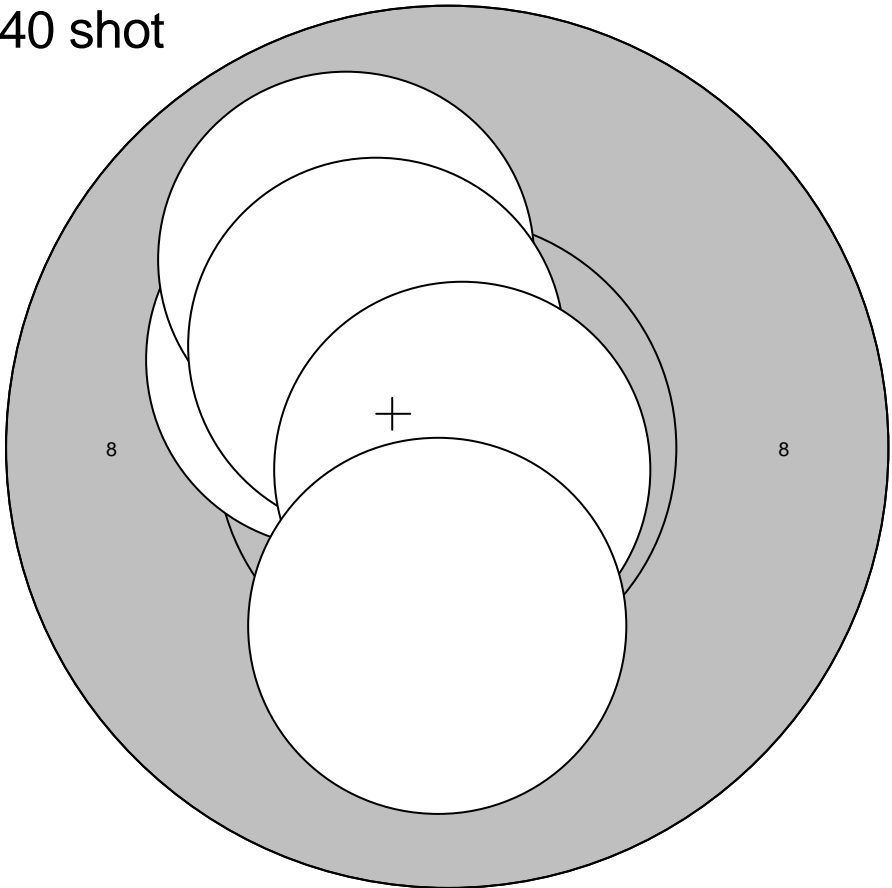
|  |                    |  |                    |
|--|--------------------|--|--------------------|
| Skjutlag<br><b>4</b>   | Tavla<br><b>22</b> | <b>Johanna Renberg</b>   |                    |
| STPL   |                    | Rönnskär   |                    |
| 2009-01-17   |                    | Skyttiaden 2009  | Umeå skytteallians |
| <b>Sight</b>   |                    | 1: 10,7* ←<br>2: 10,8* →<br>3: 10,4* ←<br>4: 10,2* ↗<br>5: 10,4* ←<br>6: 10,2* ↗<br>7: 10,4* ↙ |                    |
|   |                    | <b>Serie</b>   | <b>73,1</b>        |
|  |                    | <b>Totalt</b>  | <b>0,0</b>         |
| <b>40 shot</b>   |                    | 1: 10,3* ↗<br>2: 9,9 ↗<br>3: 10,4* ↗<br>4: 10,8* ↘<br>5: 10,1 ↓                                |                    |
|  |                    | <b>Serie</b>   | <b>51,5</b>        |
|  |                    | <b>Totalt</b>  | <b>51,5</b>        |
| <b>Umeå skf</b>  |                    |  |                    |

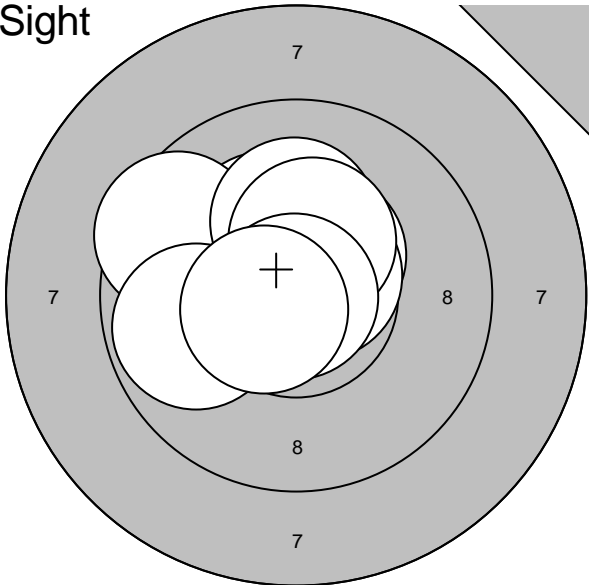
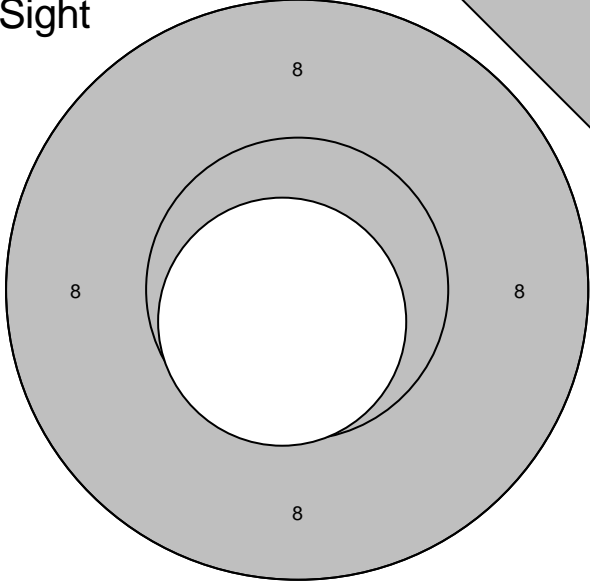
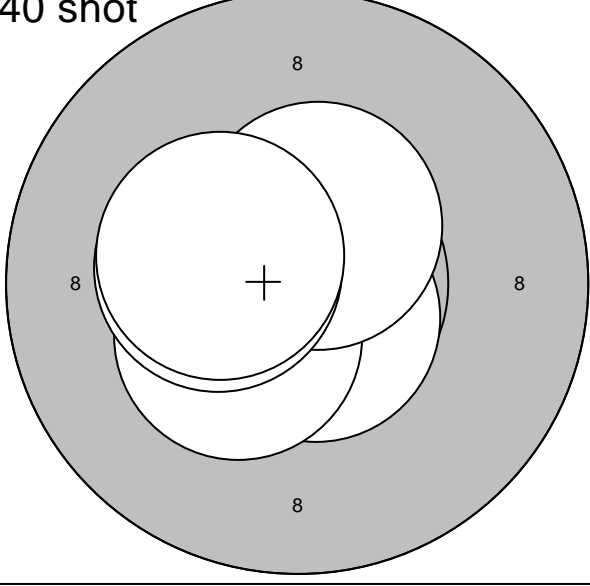
|               |   |                      |              |
|---------------|---|----------------------|--------------|
| Skjutlag      | Tavla   |                      |              |
| <b>4</b>      | <b>23</b>   | <b>Petra Nilsson</b> |              |
| STPL          | Ramselefors   |                      |              |
| 2009-01-17    | Skyttiaden 2009   | Umeå skytteallians   |              |
| Sight         |    | 1: 10,8*             | ↑            |
|               |   | 2: 10,2*             | ↖            |
|               |   | 3: 10,4*             | ↗            |
|               |   | 4: 9,5               | ↖            |
|               |   | 5: 10,2*             | ↑            |
|               |   | 6: 10,6*             | ↗            |
|               |   | 7: 10,3*             | ↑            |
|               |   | 8: 9,8               | ↖            |
|               |   | 9: 10,9*             | ↘            |
|               |   | 10: 10,6*            | ↖            |
|               |   | <b>Serie</b>         | <b>103,3</b> |
|               |   | <b>Totalt</b>        | <b>0,0</b>   |
| Sight         |   | 11: 10,7*            | ↘            |
|               |   | <b>Serie</b>         | <b>10,7</b>  |
|               |   | <b>Totalt</b>        | <b>0,0</b>   |
| 40 shot       |  | 1: 10,7*             | ↘            |
|               |   | 2: 10,4*             | ↖            |
|               |   | 3: 10,5*             | ↑            |
|               |   | 4: 10,4*             | ↖            |
|               |   | 5: 10,4*             | ↖            |
|               |   | <b>Serie</b>         | <b>52,4</b>  |
| <b>Totalt</b> | <b>52,4</b>   |                      |              |

Umeå skf

|                      |                    |                      |         |                    |            |           |       |  |
|----------------------|--------------------|----------------------|---------|--------------------|------------|-----------|-------|--|
| Skjutlag<br><b>4</b> | Tavla<br><b>24</b> | <b>Viktor Strand</b> |         |                    |            |           |       |  |
| STPL                 |                    | Ramselefors          |         |                    |            |           |       |  |
| 2009-01-17           |                    | Skyttiaden 2009      |         | Umeå skytteallians |            |           |       |  |
| Sight                |                    |                      | Sight   |                    |            |           |       |  |
|                      |                    |                      |         |                    |            |           |       |  |
| 1: 9,9 ↙             | 6:10,2* ←          | Serie                | 102,5   | 11:10,1 ↗          | 16:10,5* ↘ | Serie     | 102,8 |  |
| 2:10,1 ↓             | 7:10,4* ←          |                      |         | 12:10,4* ↙         | 17:10,6* → |           |       |  |
| 3:10,6* ↘            | 8:10,5* ↓          | Totalt               | 0,0     | 13: 9,9 →          | 18:10,3* ↘ | Totalt    | 0,0   |  |
| 4: 9,7 ↙             | 9:10,4* →          |                      |         | 14:10,7* ↘         | 19:10,0 ↘  |           |       |  |
| 5: 9,9 ↙             | 10:10,8* ↑         |                      |         |                    | 15:10,5* ↘ | 20: 9,8 ↓ |       |  |
| Sight                |                    |                      | 40 shot |                    |            |           |       |  |
|                      |                    |                      |         |                    |            |           |       |  |
| 21:10,7* ↗           |                    | Serie                | 21,4    | 1:10,3* ↙          |            | Serie     | 51,9  |  |
| 22:10,7* ↓           |                    |                      |         | 2:10,3* ←          |            |           |       |  |
|                      |                    | Totalt               | 0,0     | 3:10,4* ↓          |            | Totalt    | 51,9  |  |
|                      |                    |                      |         | 4:10,2* →          |            |           |       |  |
|                      |                    |                      |         |                    | 5:10,7* ↘  |           |       |  |
| <b>Umeå skf</b>      |                    |                      |         |                    |            |           |       |  |

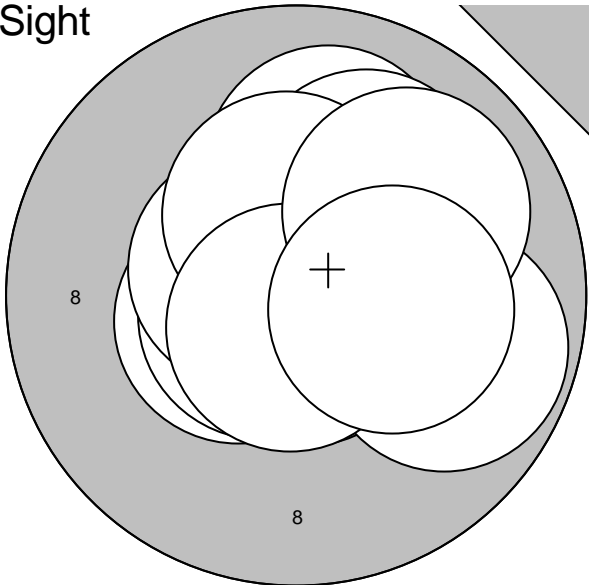
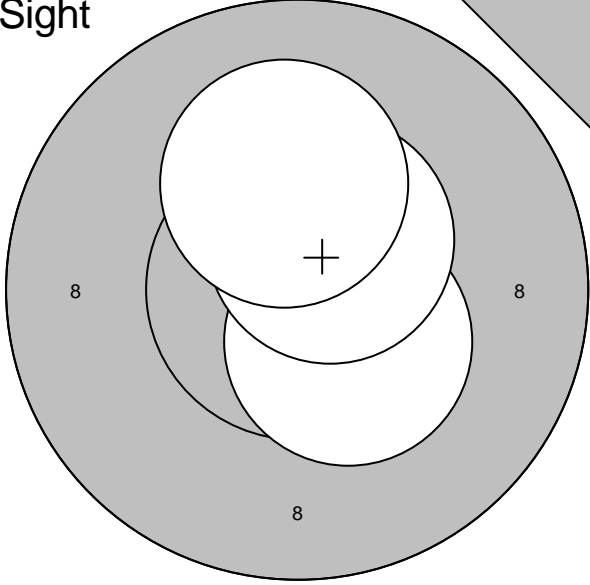
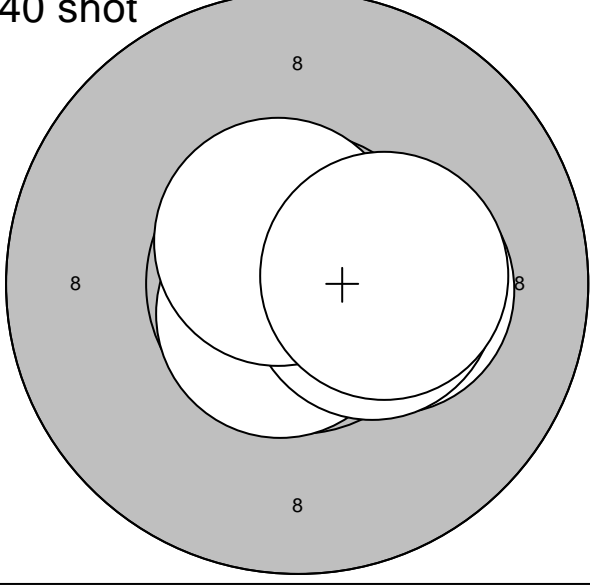
|            |   |                    |   |
|------------|---|--------------------|---|
| Skjutlag   | Tavla   | John Enardsson     |   |
| 4          | 26  |                    |   |
| STPL       | Bjurholm-Balsjö   |                    |   |
| 2009-01-17 | Skyttiaden 2009   | Umeå skytteallians |   |
| Sight      |    | 1: 10,5*           | ← |
|            |   | 2: 10,7*           | ← |
|            |   | 3: 10,0            | ↑ |
|            |   | 4: 10,1            | ↗ |
|            |   | 5: 10,6*           | ↖ |
|            |   | 6: 9,8             | → |
|            |   | 7: 10,4*           | ↑ |
|            |   | 8: 10,7*           | ↓ |
|            |   | 9: 10,0            | ↗ |
|            |   | 10: 10,3*          | → |
|            |   | Serie              |   |
| Totalt     |   | 0,0                |   |
| Sight      |   | 11: 10,4*          | ↘ |
|            |   | 12: 10,5*          | ↗ |
|            |   | 13: 10,2*          | ↑ |
| Serie      |   | 31,1               |   |
| Totalt     |   | 0,0                |   |
| 40 shot    |  | 1: 10,7*           | ↘ |
|            |   | 2: 10,3*           | → |
|            |   | 3: 10,4*           | → |
|            |   | 4: 10,6*           | ↗ |
|            |   | 5: 10,3*           | → |
| Serie      |   | 52,3               |   |
| Totalt     |   | 52,3               |   |
| Umeå skf   |   |                    |   |

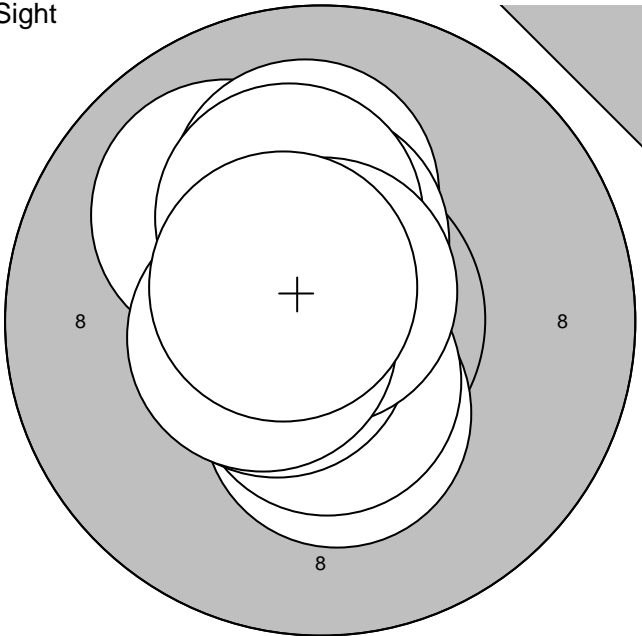
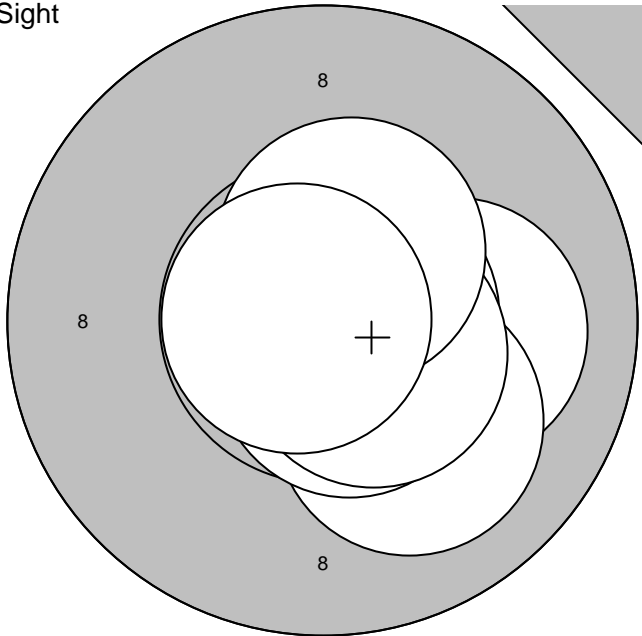
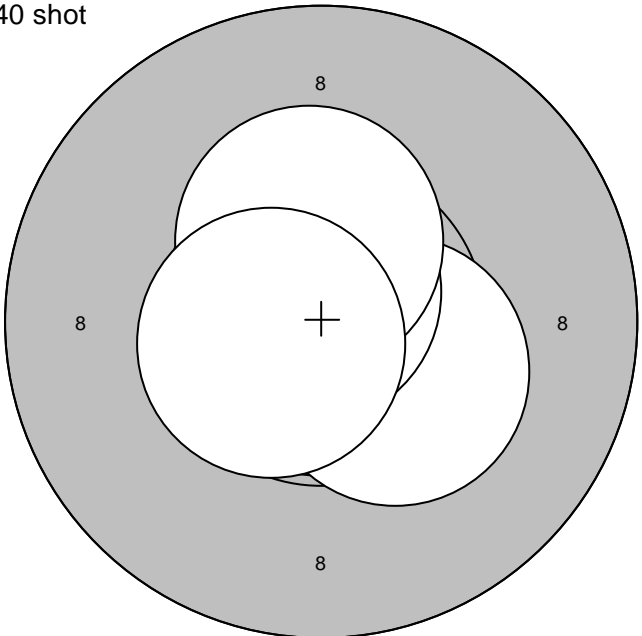
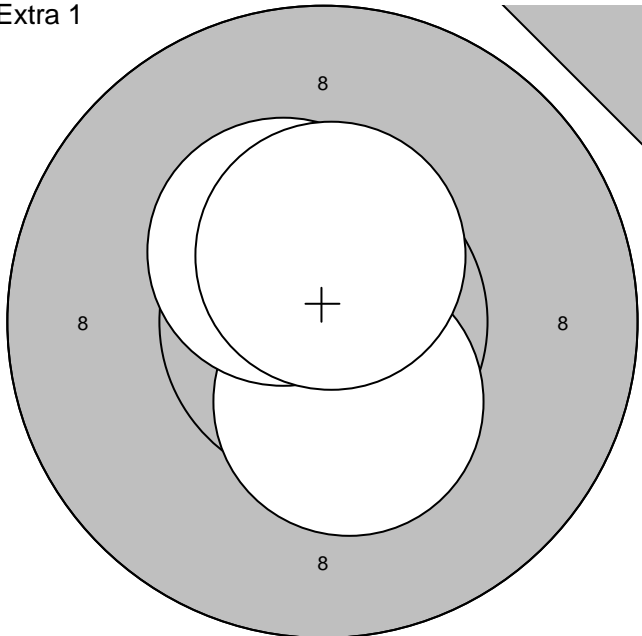

|   |                    |                       |  |                    |            |        |      |
|---|--------------------|-----------------------|--|--------------------|------------|--------|------|
| Skjutlag<br><b>4</b>  | Tavla<br><b>27</b> | <b>Hilde Karlsson</b> |  |                    |            |        |      |
| STPL  |                    | Gumboda/Ånäset        |  |                    |            |        |      |
| 2009-01-17  |                    | Skyttiaden 2009       |  | Umeå skytteallians |            |        |      |
| Sight   |                    |                       | Sight  |                    |            |        |      |
|    |                    |                       |    |                    |            |        |      |
| 1:10,0 ↖  | 6:10,2* ↑          | Serie                 | 104,0  | 11:10,1 →          | 16:10,5* ↑ | Serie  | 73,3 |
| 2:10,1 ↑  | 7:10,6* ←          |                       |  | 12:10,1 ↘          | 17:10,8* ← |        |      |
| 3:10,4* ↑   | 8:10,8* ↑          | Totalt                | 0,0  | 13:10,7* →         |            | Totalt | 0,0  |
| 4:10,3* ↓   | 9:10,5* ←          |                       |  | 14:10,6* ↘         |            |        |      |
| 5:10,5* ↓   | 10:10,6* ↖         | 40 shot               |  |                    | Extra 1    |        |      |
|  |                    |                       |  |                    |            |        |      |
| 1:10,8* ↓   |                    | Serie                 | 52,9   | 1:10,4* ↓          |            | Serie  | 31,3 |
| 2:10,4* ↘   |                    |                       |  | 2:10,4* ↖          |            |        |      |
| 3:10,7* ↗   |                    | Totalt                | 52,9   | 3:10,5* ↑          |            | Totalt | 52,9 |
| 4:10,4* ↑   |                    |                       |  |                    |            |        |      |
| 5:10,6* ←   |                    | Umeå skf              |  |                    |            |        |      |

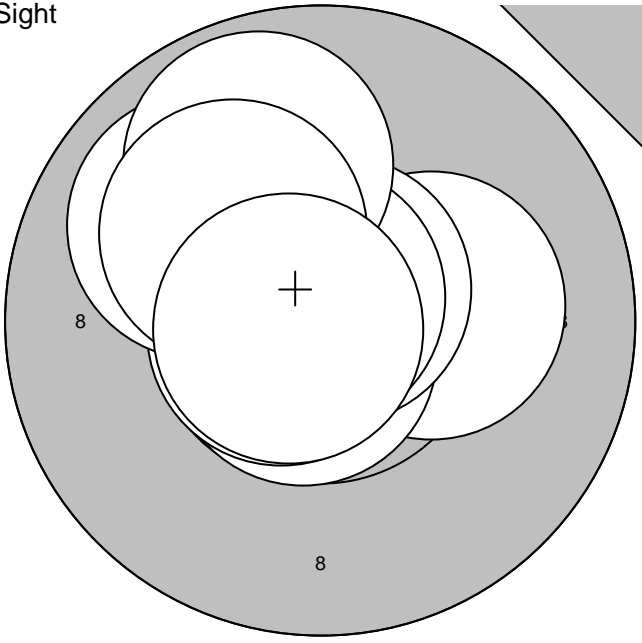
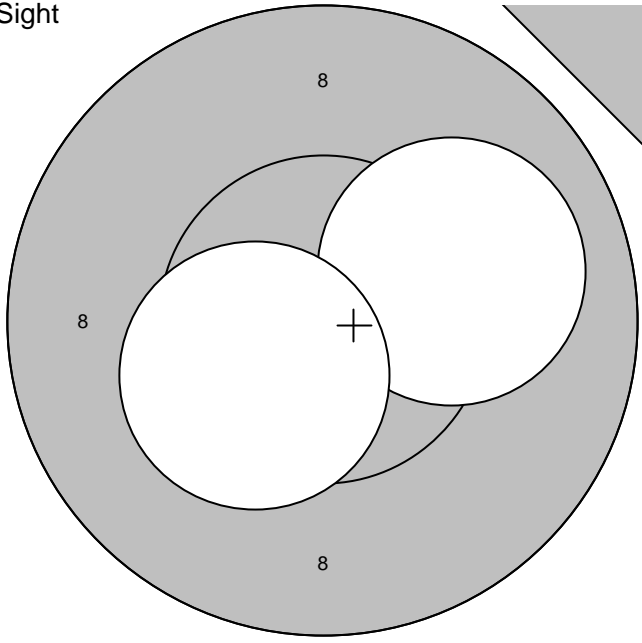
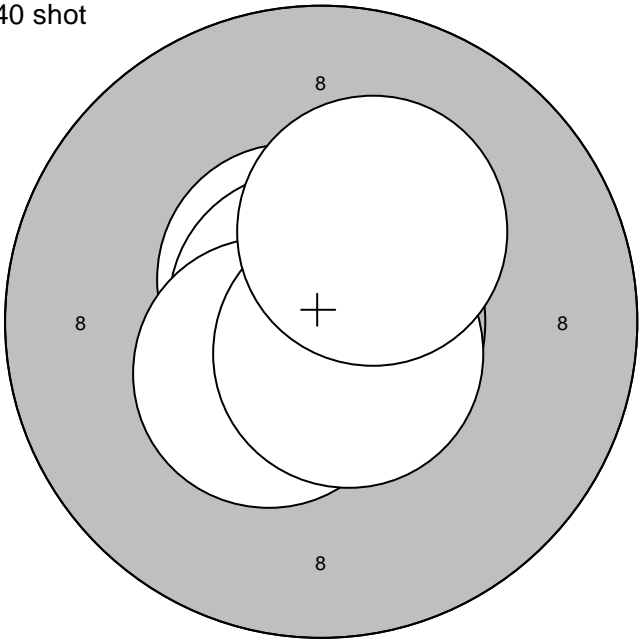
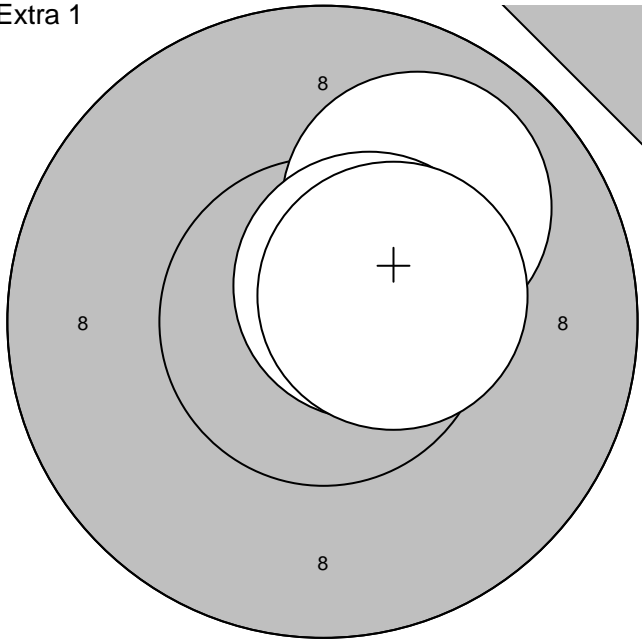
|   |                    |                      |  |                    |            |
|---|--------------------|----------------------|--|--------------------|------------|
| Skjutlag<br><b>4</b>  | Tavla<br><b>28</b> | <b>Jasmine Frank</b> |  |                    |            |
| STPL  |                    | Ramselefors          |  |                    |            |
| 2009-01-17  |                    | Skyttiaden 2009      |  | Umeå skytteallians |            |
| Sight   |                    |                      | Sight  |                    |            |
|    |                    |                      |    |                    |            |
| 1:10,2* →   | 6: 9,9 ↖           | Serie 104,3          | 11:10,0 →  | Serie 20,4         | Totalt 0,0 |
| 2:10,7* ↙   | 7:10,8* ↗          |                      | 12:10,4* ↙   |                    |            |
| 3:10,7* ↘   | 8: 9,8 ↗           | Totalt 0,0           |  | Totalt 0,0         |            |
| 4:10,7* ↗   | 9:10,1 ↖           |                      |  |                    |            |
| 5:10,7* ←   | 10:10,7* ←         |                      |  |                    |            |
| 40 shot   |                    |                      | Extra 1  |                    |            |
|  |                    |                      |  |                    |            |
| 1:10,6* ↗   | Serie 52,9         | 1:10,0 ↗             | Serie 31,1   | Totalt 52,9        |            |
| 2:10,8* ↖   |                    | 2:10,6* ↗            |  |                    |            |
| 3:10,5* ↘   | Totalt 52,9        | 3:10,5* →            | Totalt 52,9  |                    |            |
| 4:10,7* ↘   |                    |                      |  |                    |            |
| 5:10,3* ↗   |                    |                      |  |                    |            |

Umeå skf

|            |                 |   |       |
|------------|-----------------|---|-------|
| Skjutlag   | Tavla           | Jimmy Eriksson  |       |
| 4          | 29              |   |       |
| STPL       | Bjurholm-Balsjö |   |       |
| 2009-01-17 | Skyttiaden 2009 | Umeå skytteallians  |       |
| Sight      |                 | 1: 10,8* ↙<br>2: 10,5* ➔<br>3: 10,5* ↗<br>4: 10,8* ↑<br>5: 10,7* ↖<br>6: 10,9* ↗<br>7: 10,4* ↑<br>8: 10,8* ↖<br>9: 10,2* ↓<br>10: 10,5* ← |       |
|            |                 | Serie   | 106,1 |
|            |                 | Totalt  | 0,0   |
| 40 shot    |                 | 1: 9,5 ↓<br>2: 10,1 ↓<br>3: 10,8* ↓<br>4: 10,1 ↗<br>5: 10,0 ←   |       |
|            |                 | Serie   | 50,5  |
|            |                 | Totalt  | 50,5  |
| Umeå skf   |                 |   |       |